

3 V, SILICON MMIC MEDIUM OUTPUT POWER AMPLIFIER FOR MOBILE COMMUNICATIONS

FEATURES

- **SUPPLY VOLTAGE:**
 $V_{CC} = 2.7$ to 3.3 V
- **CIRCUIT CURRENT:**
 $I_{CC} = 23.0$ mA TYP at $V_{CC} = 3.0$ V
- **POWER GAIN:**
GP = 19.0 dB TYP at $f = 0.9$ GHz
GP = 21.0 dB TYP at $f = 1.9$ GHz
GP = 22.0 dB TYP at $f = 2.4$ GHz
- **MEDIUM OUTPUT POWER:**
 $PO_{(1dB)} = +8.0$ dBm TYP at $f = 0.9$ GHz
 $PO_{(1dB)} = +7.0$ dBm TYP at $f = 1.9$ GHz
 $PO_{(1dB)} = +7.0$ dBm TYP at $f = 2.4$ GHz
- **UPPER LIMIT OPERATING FREQUENCY:**
 $f_U = 4.0$ GHz TYP at 3 dB bandwidth (Standard value)
- **HIGH-DENSITY SURFACE MOUNTING:**
6-pin super minimold package ($2.0 \times 1.25 \times 0.9$ mm)

DESCRIPTION

The UPC8181TB is a silicon Monolithic Microwave Integrated Circuit designed as an amplifier for mobile communications. This IC operates at 3 volts. The medium output power is suitable for RF-TX of mobile communication systems.

This IC is manufactured using the 30 GHz f_{max} UHSO (Ultra High Speed process) silicon bipolar process. This process uses direct silicon nitride passivation film and gold electrodes. These materials can protect the chip surface from pollution and prevent corrosion/migration. This IC has excellent performance, uniformity, and reliability.

Stringent quality assurance and test procedures ensure the highest reliability and performance.

ELECTRICAL CHARACTERISTICS

($T_A = 25^\circ\text{C}$, $V_{CC} = V_{OUT} = 3.0$ V, $Z_S = Z_L = 50\Omega$)

PART NUMBER PACKAGE OUTLINE			UPC8181TB S06		
SYMBOLS	PARAMETERS AND CONDITIONS	UNITS	MIN	TYP	MAX
I_{CC}	Circuit Current (no signal)	mA	–	23.0	30.0
GP	Power Gain, $f = 0.9$ GHz $f = 1.9$ GHz $f = 2.4$ GHz	dB	16.0 18.0 19.0	19.0 21.0 22.0	22.0 24.0 25.0
NF	Noise Figure, $f = 0.9$ GHz $f = 1.9$ GHz $f = 2.4$ GHz	dB	– – –	4.5 4.5 4.5	6.0 6.0 6.0
f_U	Upper Limit Operating Frequency, 3 dB down below from gain at $f = 0.1$ GHz	GHz	–	4.0	–
ISL	Isolation, $f = 0.9$ GHz $f = 1.9$ GHz $f = 2.4$ GHz	dB	28.0 27.0 26.5	33.0 32.0 31.5	– – –

NOISE FIGURE, POWER GAIN vs.
FREQUENCY

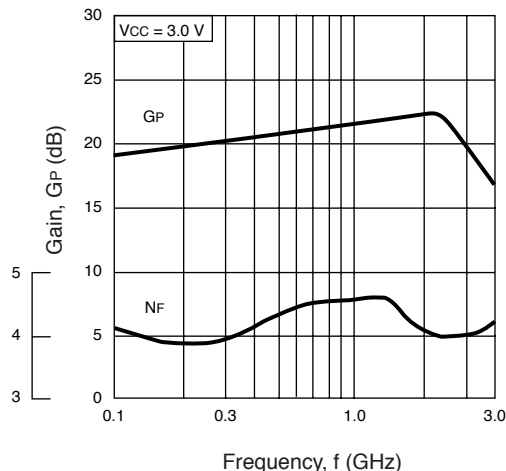

APPLICATIONS

- Buffer amplifiers for 1.9 GHz to 2.4 GHz mobile communication systems.

ELECTRICAL CHARACTERISTICS (cont.)

($T_A = 25^\circ\text{C}$, $V_{CC} = V_{OUT} = 3.0\text{ V}$, $Z_S = Z_L = 50\Omega$)

PART NUMBER PACKAGE OUTLINE			UPC8181TB S06		
SYMBOLS	PARAMETERS AND CONDITIONS	UNITS	MIN	TYP	MAX
$P_{O(1dB)}$	1 dB Gain Compression Output Level, f = 0.9 GHz f = 1.9 GHz f = 2.4 GHz	dBm	+5.5 +4.5 +4.5	+8.0 +7.0 +7.0	– – –
$P_{O(SAT)}$	Saturated Output Power Level, f = 0.9 GHz, $P_{IN} = -5\text{ dBm}$ f = 1.9 GHz, $P_{IN} = -5\text{ dBm}$ f = 2.4 GHz, $P_{IN} = -5\text{ dBm}$	dBm	– – –	+9.5 +9.0 +9.0	– – –
RL_{in}	Input Return Loss, f = 0.9 GHz f = 1.9 GHz f = 2.4 GHz	dB	4.5 7.5 8.0	7.5 10.5 11.0	– – –
RL_{out}	Output Return Loss, f = 0.9 GHz f = 1.9 GHz f = 2.4 GHz	dB	6.0 7.0 9.0	9.0 10.0 12.0	– – –

ABSOLUTE MAXIMUM RATINGS¹

SYMBOLS	PARAMETERS	UNITS	RATINGS
V_{CC}	Supply Voltage ²	V	3.6
I_{CC}	Total Circuit Current	mA	60
P_D	Power Dissipation ³	mW	270
T_A	Operating Ambient Temperature	$^\circ\text{C}$	-40 to +85
T_{STG}	Storage Temperature	$^\circ\text{C}$	-55 to +150
P_{IN}	Input Power ⁴	dBm	+10

Notes:

1. Operation in excess of any one of these conditions may result in permanent damage.
2. $T_A = 25^\circ\text{C}$, pins 4 and 6.
3. Mounted on a double-sided copper clad 50x50x1.6 mm epoxy glass PWB, $T_A = +85^\circ\text{C}$.
4. $T_A = +25^\circ\text{C}$

RECOMMENDED OPERATING CONDITIONS

SYMBOLS	PARAMETERS	UNITS	MIN	TYP	MAX
V_{CC}	Supply Voltage ¹	V	2.7	3.0	3.3

Note:

1. Same voltage applied to pins 4 and 6

TYPICAL PERFORMANCE CURVES (Unless otherwise specified, $T_A = 25^\circ\text{C}$)

CIRCUIT CURRENT vs. SUPPLY VOLTAGE

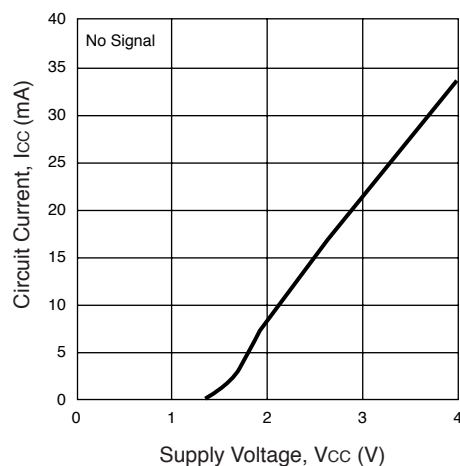

CIRCUIT CURRENT vs. OPERATING AMBIENT TEMPERATURE

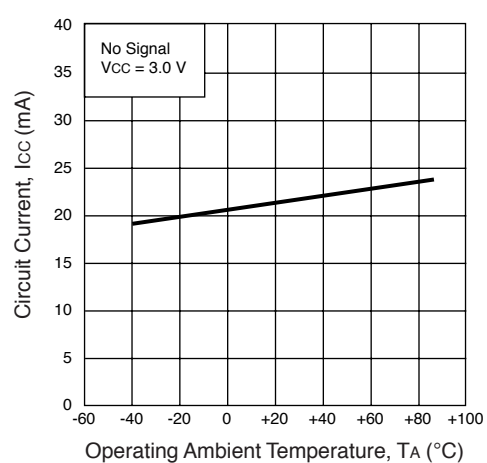

TYPICAL PERFORMANCE CURVES (Unless otherwise specified, $T_A = 25^\circ\text{C}$)

ISOLATION vs. FREQUENCY

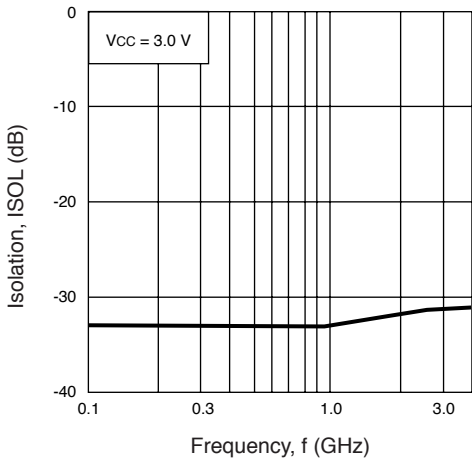

INPUT RETURN LOSS, OUTPUT RETURN LOSS vs. FREQUENCY

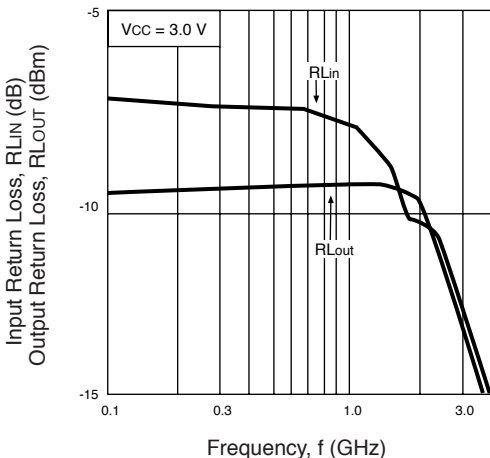

OUTPUT POWER vs. INPUT POWER

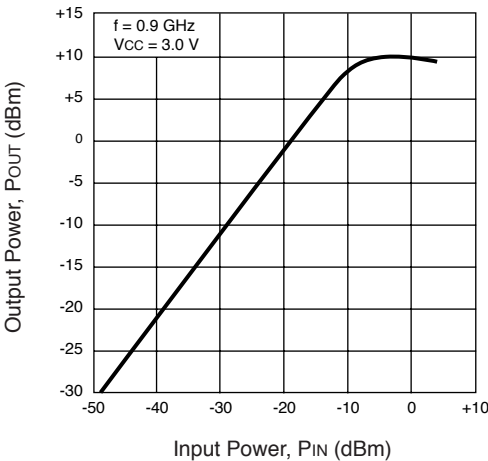

OUTPUT POWER vs. INPUT POWER

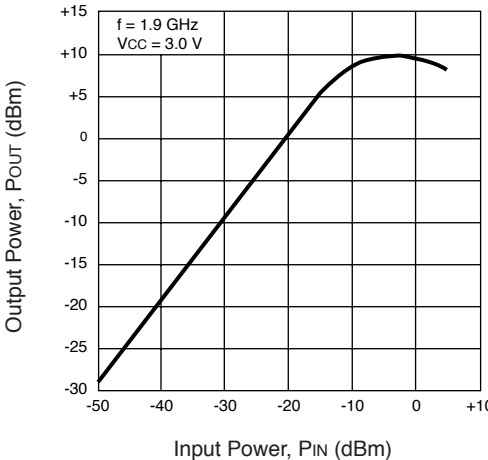

OUTPUT POWER vs. INPUT POWER

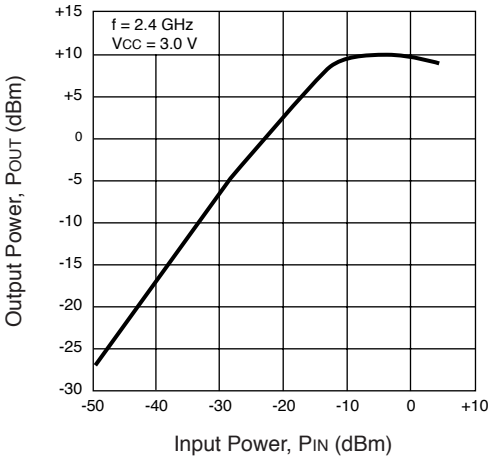

SATURATED OUTPUT POWER vs. FREQUENCY

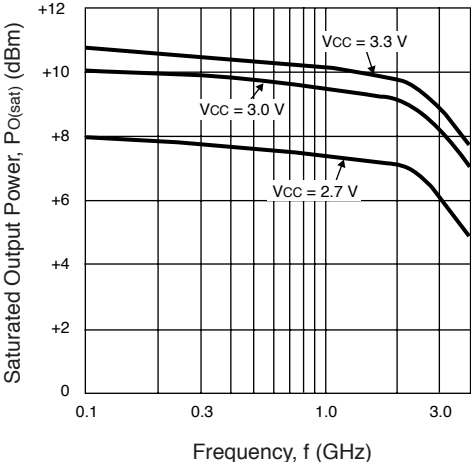

TYPICAL PERFORMANCE CURVES (Unless otherwise specified, $T_A = 25^\circ\text{C}$)

THIRD ORDER INTERMODULATION DISTORTION vs. OUTPUT POWER OF EACH TONE

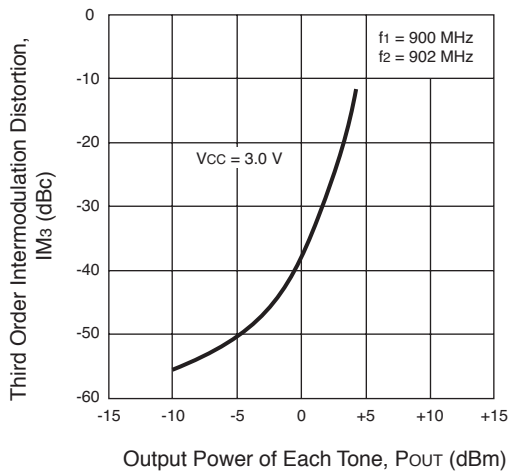

THIRD ORDER INTERMODULATION DISTORTION vs. OUTPUT POWER OF EACH TONE

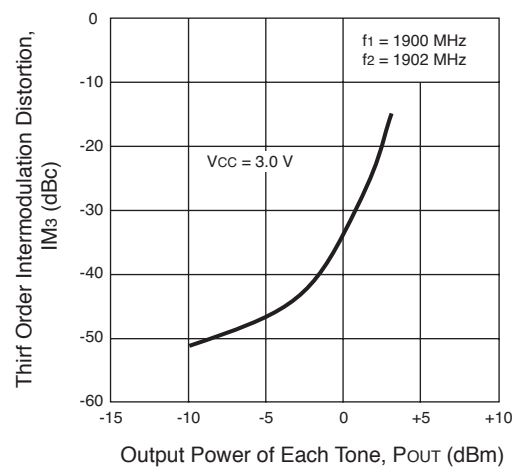

THIRD ORDER INTERMODULATION DISTORTION vs. OUTPUT POWER OF EACH TONE

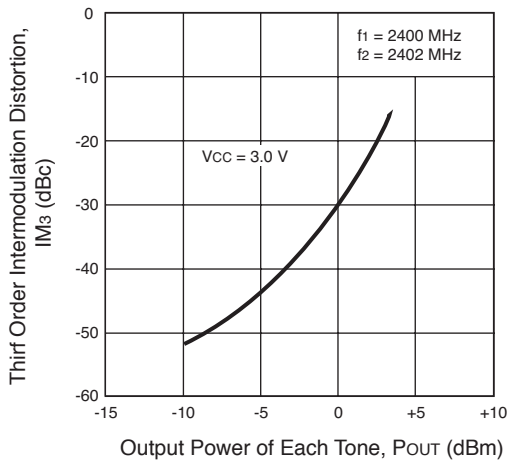

TYPICAL SCATTERING PARAMETERS ($T_A = 25^\circ\text{C}$)

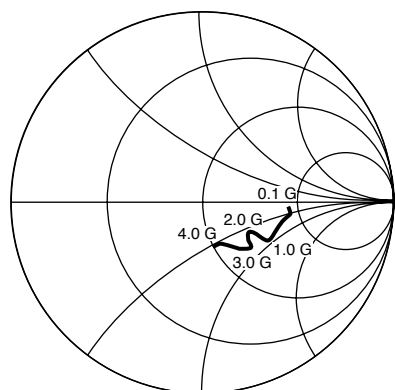

S11

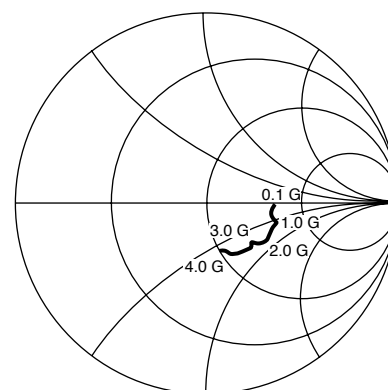

S22

Coordinates in Ohms
Frequency in GHz
 $V_{CC} = V_{OUT} = 3.0\text{ V}$, $I_{CC} = 23$

$V_{CC} = V_{OUT} = 3.0\text{ V}$, $I_{CC} = 23.0\text{ mA}$

FREQUENCY GHz	S11		S21		S12		S22		K
	MAG	ANG	MAG	ANG	MAG	ANG	MAG	ANG	
0.1	0.452	-2.7	9.078	-2.0	0.020	4.3	0.338	-1.6	1.89
0.2	0.467	-5.7	9.098	-4.9	0.021	4.2	0.346	-2.1	1.73
0.3	0.470	-7.5	9.143	-6.9	0.021	8.2	0.344	-1.0	1.72
0.4	0.460	-9.3	9.237	-10.1	0.021	9.8	0.335	-2.7	1.75
0.5	0.438	-11.5	9.284	-11.9	0.021	11.4	0.328	-4.8	1.84
0.6	0.415	-14.7	9.442	-14.6	0.022	8.1	0.337	-7.5	1.73
0.7	0.397	-18.6	9.670	-17.0	0.022	11.5	0.350	-7.9	1.72
0.8	0.395	-22.4	9.897	-19.7	0.022	16.3	0.354	-6.8	1.69
0.9	0.399	-25.6	10.166	-22.7	0.023	14.5	0.342	-6.0	1.56
1.0	0.404	-28.1	10.496	-26.0	0.022	13.4	0.331	-7.9	1.60
1.1	0.396	-29.0	10.903	-29.0	0.023	18.0	0.332	-10.8	1.48
1.2	0.394	-28.5	11.329	-32.8	0.025	16.6	0.353	-13.4	1.33
1.3	0.385	-28.0	11.895	-37.9	0.025	17.4	0.376	-14.3	1.26
1.4	0.368	-28.8	12.145	-42.4	0.024	22.0	0.374	-15.0	1.28
1.5	0.347	-29.5	12.356	-47.6	0.025	24.3	0.361	-16.3	1.28
1.6	0.335	-30.9	12.670	-51.8	0.026	20.6	0.356	-19.3	1.22
1.7	0.327	-31.5	12.966	-56.4	0.024	21.4	0.356	-22.0	1.29
1.8	0.328	-31.2	13.410	-61.4	0.026	23.2	0.366	-23.9	1.17
1.9	0.327	-29.4	13.722	-66.8	0.027	27.5	0.367	-25.6	1.11
2.0	0.325	-29.4	14.151	-72.3	0.026	24.6	0.369	-28.5	1.11
2.1	0.316	-28.5	14.412	-78.1	0.028	26.4	0.363	-31.7	1.05
2.2	0.295	-29.4	14.747	-84.1	0.027	26.5	0.361	-35.4	1.08
2.3	0.288	-30.8	15.144	-90.3	0.029	27.5	0.359	-37.1	1.02
2.4	0.291	-34.1	15.463	-97.4	0.029	27.1	0.346	-39.0	1.01
2.5	0.303	-38.3	15.264	-104.6	0.029	27.7	0.323	-40.6	1.04
2.6	0.317	-41.1	15.137	-112.6	0.028	25.5	0.303	-43.1	1.09
2.7	0.335	-41.3	14.774	-119.8	0.029	25.5	0.294	-43.9	1.07
2.8	0.349	-41.0	14.176	-127.7	0.031	25.0	0.299	-43.0	1.03
2.9	0.347	-39.4	13.710	-133.7	0.029	32.9	0.304	-41.3	1.09
3.0	0.345	-43.2	12.808	-139.8	0.029	24.8	0.317	-44.9	1.15
3.1	0.341	-45.4	12.313	-146.0	0.031	28.9	0.325	-46.7	1.13
3.2	0.331	-47.9	11.587	-149.3	0.029	31.6	0.318	-48.7	1.25
3.3	0.323	-49.8	11.003	-154.5	0.031	31.2	0.315	-52.1	1.27
3.4	0.311	-52.1	10.638	-157.7	0.031	29.5	0.307	-56.1	1.32
3.5	0.302	-52.6	10.228	-162.0	0.029	32.5	0.302	-60.0	1.44
3.6	0.289	-54.9	9.985	-166.5	0.030	31.4	0.303	-63.7	1.47
3.7	0.266	-56.5	9.543	-170.1	0.030	39.6	0.301	-65.1	1.54
3.8	0.253	-61.5	9.184	-174.5	0.031	34.1	0.294	-67.5	1.55
3.9	0.238	-65.6	8.816	-177.7	0.030	36.2	0.275	-68.8	1.71
4.0	0.238	-70.7	8.488	178.2	0.032	38.9	0.270	-71.0	1.70
4.1	0.244	-74.0	8.186	174.3	0.032	37.0	0.266	-75.1	1.75

UPC8181TB

PIN FUNCTIONS (Pin Voltage is measured at Vcc = 3.0 V)

Pin No.	Pin Name	Applied Voltage	Pin Voltage	Description	Equivalent Circuit
1	INPUT	—	0.99	Signal input pin. An internal matching circuit, configured with resistors, enables 50 Ω connection over a wide band. A multi-feedback circuit is designed to cancel the deviations of hFE and resistance. This pin must be coupled to signal source with capacitor for DC cut.	
2 3 5	GND	0	—	GND pin. This pin should be connected to the system ground with minimum inductance. Ground pattern on the board should be formed as wide as possible. All the ground pins must be connected together with wide ground pattern to decrease impedance difference.	
4	OUTPUT	Voltage as same as Vcc through external inductor	—	Signal output pin. The inductor must be attached between Vcc and output pins to supply current to the internal output transistors.	
6	Vcc	2.7 to 3.3	—	Power supply pin, which biases the internal input transistor. This pin should be externally equipped with bypass capacitor to minimize its impedance.	

APPLICATION EXAMPLE (Digital Cellular Telephone)

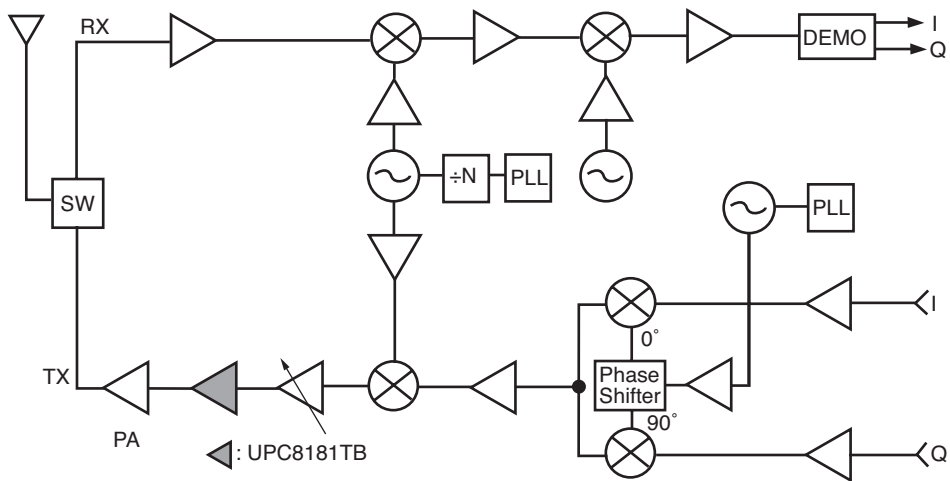

OUTLINE DIMENSIONS (Units in mm)

6-PIN SUPER MINIMOLD

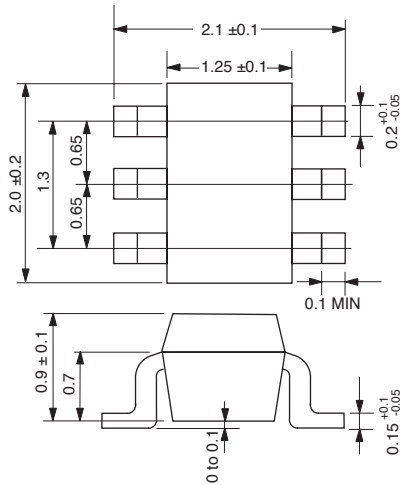

LEAD CONNECTIONS

(Top View)

(Bottom View)

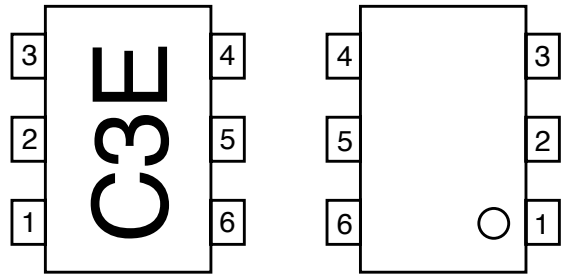

1. INPUT
2. GND
3. GND
4. OUTPUT
5. GND
6. Vcc

ORDERING INFORMATION

PART NUMBER	PACKAGE	QUANTITY
UPC8181TB-E3-A	6-pin super minimold	3kpcs/Reel

Note: Embossed tape 8 mm wide. Pins 1,2,3 face tape perforation side.

TEST CIRCUIT

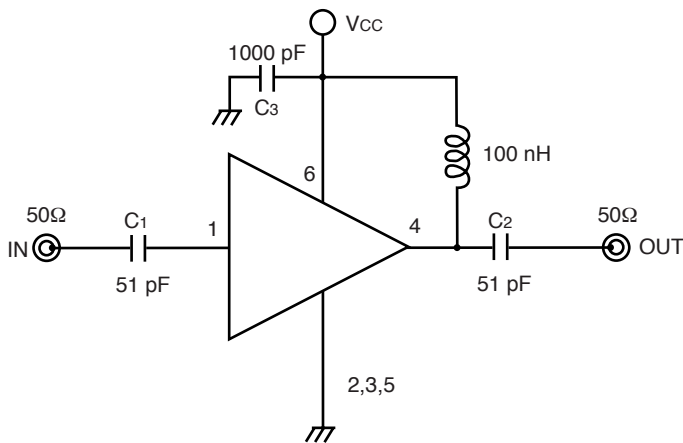

APPLICATION BOARD

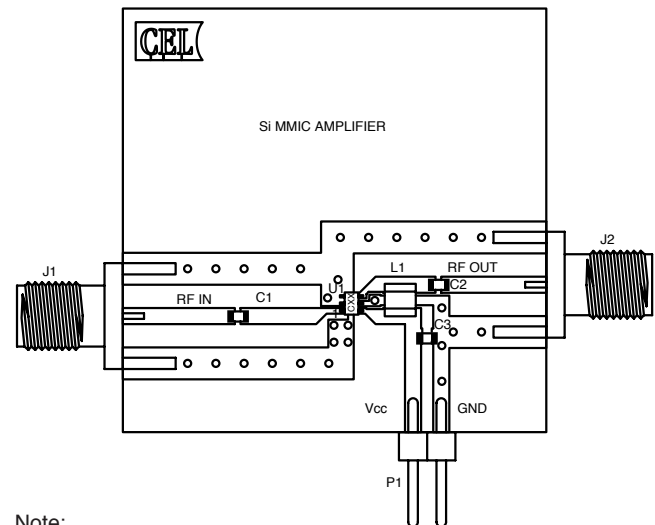

Note:

1. double sided copper clad GETEK board (H = .028, $\epsilon_r = 4.2$.)
2. Back side: GND pattern.
3. Solder plated on patterns.
4. o O : Through holes.

EXCLUSIVE NORTH AMERICAN AGENT FOR RF, MICROWAVE & OPTOELECTRONIC SEMICONDUCTORS