

# Model 375

## HFF LVDS VCXO

### Features

- Ceramic Surface Mount Package
- Ultra-Low Phase Jitter Performance
- High Frequency Fundamental Crystal Design
- Frequency Range 100 – 250MHz \*
- +2.5V or +3.3V Operation
- Output Enable Standard
- Tape and Reel Packaging, EIA-418

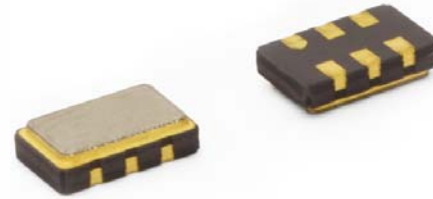

Part Dimensions:  
5.0 × 3.2 × 1.2mm • 62.28mg

### Applications

- Small Cells
- Wireless Communication
- Broadband Access
- SONET/SDH/DWDM
- Base Stations
- Ethernet/GbE/SyncE
- Digital Video
- Test and Measurement

#### Standard Frequencies

- 100.00MHz
- 122.88MHz
- 125.00MHz
- 153.60MHz
- 155.52MHz
- 156.25MHz
- 166.00MHz
- 200.00MHz
- 204.80MHz
- 245.76MHz

\* Check with factory for availability.

### Description

CTS Model 375 is a low cost, small size, high performance VCXO. Employing the latest IC technology, coupled with a high frequency fundamental crystal, M375 has excellent stability and low jitter/phase noise performance.

### Ordering Information

Model	Supply Voltage	Absolute Pull Range	Frequency Stability	Temperature Range	Frequency Code [MHz]	Packaging																		
375	L	B	3	I	XXX or XXXX	T																		
	<table border="1"> <thead> <tr> <th>Code</th> <th>Voltage</th> </tr> </thead> <tbody> <tr> <td>L</td> <td>+3.3V ±5%</td> </tr> <tr> <td>N</td> <td>+2.5V ±5%</td> </tr> </tbody> </table>	Code	Voltage	L	+3.3V ±5%	N	+2.5V ±5%		<table border="1"> <thead> <tr> <th>Code</th> <th>Stability</th> </tr> </thead> <tbody> <tr> <td>3</td> <td>±50ppm</td> </tr> <tr> <td>5</td> <td>±25ppm</td> </tr> <tr> <td>6</td> <td>±20ppm<sup>1</sup></td> </tr> </tbody> </table>	Code	Stability	3	±50ppm	5	±25ppm	6	±20ppm <sup>1</sup>		<table border="1"> <thead> <tr> <th>Code</th> <th>Frequency</th> </tr> </thead> <tbody> <tr> <td colspan="2">Product Frequency Code<sup>2</sup></td> </tr> </tbody> </table>	Code	Frequency	Product Frequency Code <sup>2</sup>		
Code	Voltage																							
L	+3.3V ±5%																							
N	+2.5V ±5%																							
Code	Stability																							
3	±50ppm																							
5	±25ppm																							
6	±20ppm <sup>1</sup>																							
Code	Frequency																							
Product Frequency Code <sup>2</sup>																								
		<table border="1"> <thead> <tr> <th>Code</th> <th>APR</th> </tr> </thead> <tbody> <tr> <td>B</td> <td>±50ppm<sup>3</sup></td> </tr> </tbody> </table>	Code	APR	B	±50ppm <sup>3</sup>	<table border="1"> <thead> <tr> <th>Code</th> <th>Temp. Range</th> </tr> </thead> <tbody> <tr> <td>C</td> <td>-20°C to +70°C</td> </tr> <tr> <td>I</td> <td>-40°C to +85°C</td> </tr> </tbody> </table>	Code	Temp. Range	C	-20°C to +70°C	I	-40°C to +85°C	<table border="1"> <thead> <tr> <th>Code</th> <th>Packing</th> </tr> </thead> <tbody> <tr> <td>T</td> <td>1k pcs./reel</td> </tr> </tbody> </table>	Code	Packing	T	1k pcs./reel						
Code	APR																							
B	±50ppm <sup>3</sup>																							
Code	Temp. Range																							
C	-20°C to +70°C																							
I	-40°C to +85°C																							
Code	Packing																							
T	1k pcs./reel																							

Notes:

- 1] Only available with "C" temperature range.
- 2] Refer to document 016-1454-0, Frequency Code Tables.  
3-digits for frequencies <100MHz, 4-digits for frequencies 100MHz or greater.
- 3] Frequencies ≥200MHz, APR is ±30ppm.

**Not all performance combinations and frequencies may be available.  
Contact your local CTS Representative or CTS Customer Service for availability.**

## Electrical Specifications

### Operating Conditions

PARAMETER	SYMBOL	CONDITIONS	MIN	TYP	MAX	UNIT
Maximum Supply Voltage	$V_{CC}$	-	-0.3	-	5.0	V
Maximum Control Voltage	$V_C$	-	-0.5	-	$V_{CC}$	V
Supply Voltage	$V_{CC}$	±5%	3.14	3.3	3.47	V
			2.38	2.5	2.63	
Supply Current	$I_{CC}$	LVDS Load	-	20	55	mA
Output Load	$R_L$	Between Outputs	-	100	-	Ohms
Operating Temperature	$T_A$	-	-20	+25	+70	°C
			-40		+85	
Storage Temperature	$T_{STG}$	-	-40	-	+100	°C

### Frequency Stability

PARAMETER	SYMBOL	CONDITIONS	MIN	TYP	MAX	UNIT
Frequency Range	$f_0$	-		100 - 250		MHz
Frequency Stability [Note 1]	$\Delta f/f_0$	±20ppm stability, -20°C to +70°C only		20, 25 or 50		±ppm
Absolute Pull Range [Note 2]	APR	Frequencies ≥200MHz, APR is ±30ppm	50	-	-	±ppm
Aging	$\Delta f/f_{25}$	First Year @ +25°C, nominal $V_{CC}$ and $V_C$	-3	-	3	ppm

1.] Inclusive of initial tolerance at time of shipment, changes in supply voltage, load, temperature and 1st year aging.

2.] Minimum guaranteed frequency shift from  $f_0$  over variations in temperature, aging, power supply and load.

### Output Parameters

PARAMETER	SYMBOL	CONDITIONS	MIN	TYP	MAX	UNIT
Output Type	-	-		LVDS		-
Output Voltage Levels	$V_{OH}$	LVDS Load	-	1.43	1.60	V
	$V_{OL}$	LVDS Load	0.90	1.10	-	
Differential Output Voltage	$V_{OD}$	$R_L = 100$ Ohms	247	350	454	mV
Offset Voltage	$V_{OS}$	$R_L = 100$ Ohms	1.125	1.25	1.375	V
Output Duty Cycle	SYM	@ 1.25V	45	-	55	%
Rise and Fall Time	$T_R, T_F$	@ 20%/80% Levels	-	0.4	1.0	ns
Start Up Time	$T_S$	Application of $V_{CC}$	-	5	10	ms
<b>Enable Function</b>						
Enable Input Voltage	$V_{IH}$	Pin 2 Logic '1', Output Enabled	$0.7V_{CC}$	-	-	V
Disable Input Voltage	$V_{IL}$	Pin 2 Logic '0', Output Disabled	-	-	$0.3V_{CC}$	V
Standby Current	$I_{STB}$	Pin 2 Logic '0', Output Standby	-	-	10	µA
Enable Time	$T_{PLZ}$	Pin 2 Logic '1'	-	-	20	µs
Phase Jitter, RMS	$t_{jrms}$	Bandwidth 12 kHz - 20 MHz	-	70	500	fs
Phase Noise	-	See Typical Plots	-	-	-	-

### Electrical Specifications

#### Enable Truth Table

Pin 2	Pin 4 & 5	Pin 2	Pin 4 & 5	Pin 2	Pin 4 & 5
Logic '1'	Output	Open	Output	Logic '0'	High Imp.

#### Control Voltage

PARAMETER	SYMBOL	CONDITIONS	MIN	TYP	MAX	UNIT
Control Voltage	$V_C$	-	0.30	1.65	3.00	V
Frequency Deviation	$\Delta f/f_0$	$V_C = 0.0V$ $V_C = 3.3V$		-155 to -75 75 to 155		ppm
Linearity	L	Best Straight Line Fit	-	5	10	%
Gain Transfer	$K_V$	Pull Sensitivity; @ +1.65V, +25°C	-	75	-	ppm/V
Input Impedance	$Z_{V_C}$	-	10	-	-	MOhms
Modulation Roll-off	-	@ -3dB	20	-	-	kHz
Transfer Function	-	-		Positive		-

#### Test Circuit

LVDS

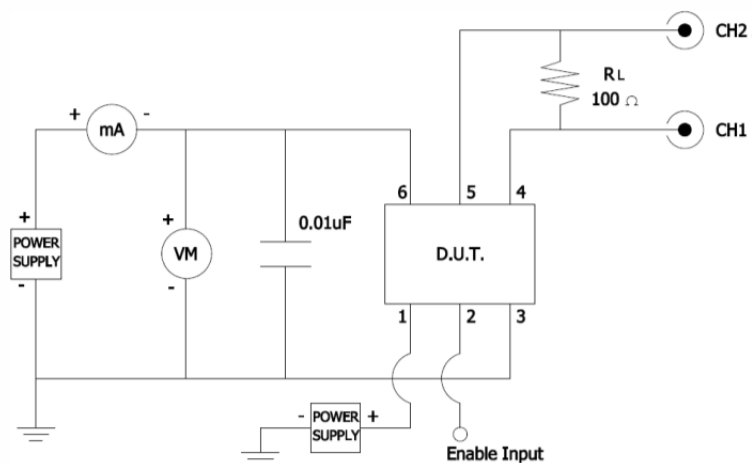

#### Output Waveform

LVDS

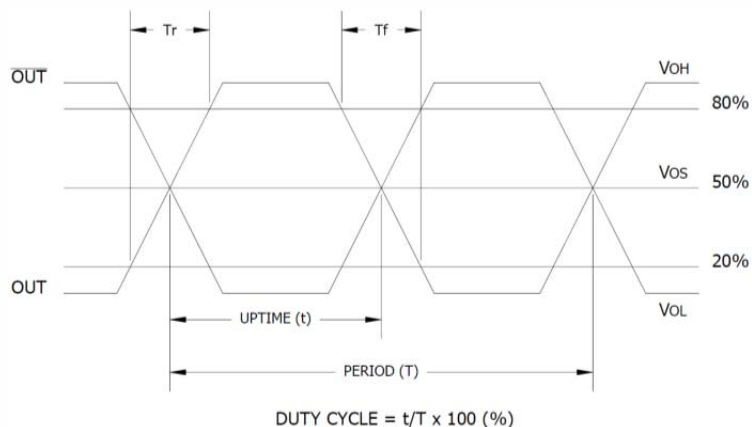

## Electrical Specifications

### Performance Data

#### Frequency Deviation – Over Temperature [typical]

122.88MHz,  $V_{CC} = 3.3V$ ,  $V_C = 1.65V$



156.25MHz,  $V_{CC} = 3.3V$ ,  $V_C = 1.65V$

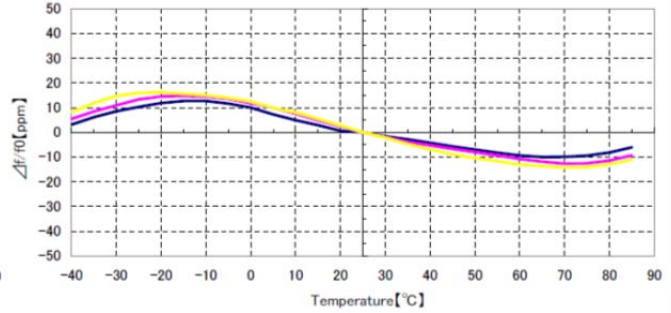

#### Frequency Deviation – Pulling Range [typical]

122.88MHz,  $V_{CC} = 3.3V$ ,  $T_A = +25^\circ V$



156.25MHz,  $V_{CC} = 3.3V$ ,  $T_A = +25^\circ V$

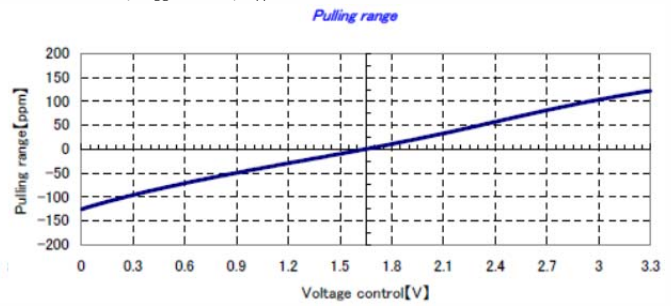

#### Frequency Deviation – Gain Transfer [typical]

122.88MHz,  $V_{CC} = 3.3V$ ,  $T_A = +25^\circ V$

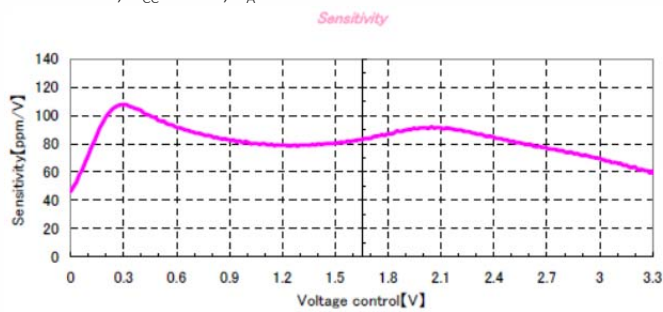

156.25MHz,  $V_{CC} = 3.3V$ ,  $T_A = +25^\circ V$

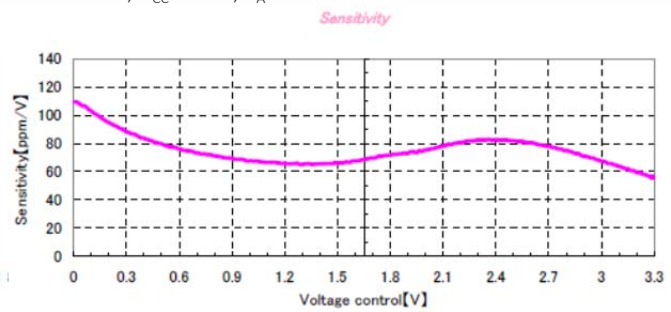



### Electrical Specifications

#### Performance Data

Phase Noise [typical]

122.88MHz,  $V_{CC} = 3.3V$ ,  $V_C = 1.65V$ ,  $T_A = +25^\circ C$

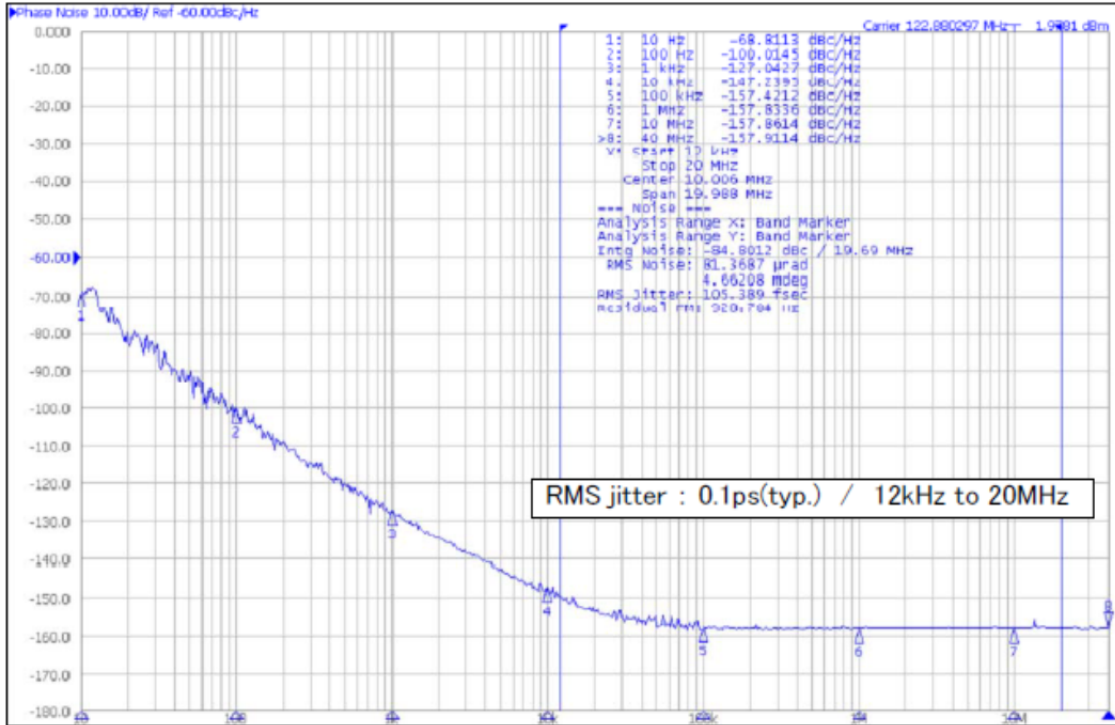

156.25MHz,  $V_{CC} = 3.3V$ ,  $V_C = 1.65V$ ,  $T_A = +25^\circ C$

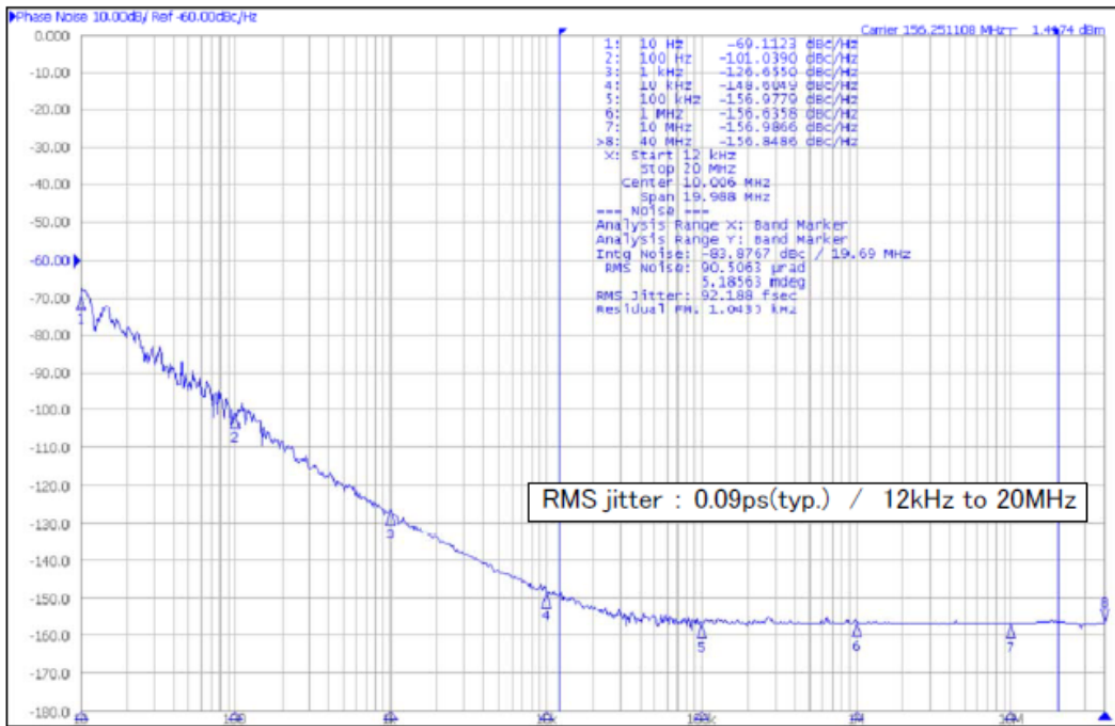

## Mechanical Specifications

### Package Drawing



### Marking Information

- \*\* - Manufacturing Site Code.
- D – Date Code. See Table I for codes.
- ST – Frequency Stability/Temperature Code. [Refer to Ordering Information]
- V – Voltage Code. L = 3.3V, N = 2.5V
- xxxx – Frequency Code. 4-digits required for frequencies 100MHz and above. [See document 016-1454-0, Frequency Code Tables.]

### Recommended Pad Layout



### Notes

- Termination pads (e4). Barrier-plating is nickel [Ni] with gold [Au] flash plate.
- Reflow conditions per JEDEC J-STD-020; +260°C maximum, 20 seconds.
- MSL = 1.

### Pin Assignments

Pin	Symbol	Function
1	V <sub>C</sub>	Control Voltage
2	EOH	Enable
3	GND	Circuit & Package
4	Output	RF Output
5	Output	RF Output, Complementary
6	V <sub>CC</sub>	Supply Voltage

Table I - Date Code

		MONTH														
YEAR		JAN	FEB	MAR	APR	MAY	JUN	JUL	AUG	SEP	OCT	NOV	DEC			
2001	2005	2009	2013	2017	A	B	C	D	E	F	G	H	J	K	L	M
2002	2006	2010	2014	2018	N	P	Q	R	S	T	U	V	W	X	Y	Z
2003	2007	2011	2015	2019	a	b	c	d	e	f	g	h	j	k	l	m
2004	2008	2012	2016	2020	n	p	q	r	s	t	u	v	w	x	y	z

### Packaging - Tape and Reel

#### Tape Drawing



#### Reel Drawing



#### Notes

1. Device quantity is 1k pieces maximum per 180mm reel.
2. Complete CTS part number, frequency value and date code information must appear on reel and carton labels.