



KSZ9031RNX

Gigabit Ethernet Transceiver with RGMII Support

KSZ9031RNX-EVAL Board User's Guide

Revision 1.1 / August 2012

© Micrel, Inc. 2012
All rights reserved

Micrel is a registered trademark of Micrel and its subsidiaries in the United States and certain other countries. All other trademarks are the property of their respective owners.

The information furnished by Micrel in this datasheet is believed to be accurate and reliable. However, no responsibility is assumed by Micrel for its use. Micrel reserves the right to change circuitry and specifications at any time without notification to the customer. Micrel Products are not designed or authorized for use as components in life support appliances, devices or systems where malfunction of a product can reasonably be expected to result in personal injury. Life support devices or systems are devices or systems that (a) are intended for surgical implant into the body or (b) support or sustain life, and whose failure to perform can be reasonably expected to result in a significant injury to the user. A Purchaser's use or sale of Micrel Products for use in life support appliances, devices or systems is at Purchaser's own risk and Purchaser agrees to fully indemnify Micrel for any damages resulting from such use or sale.

Micrel, Inc. ♦ 2180 Fortune Drive ♦ San Jose, CA 95131 ♦ U.S.A.
408-944-0800 (voice) ♦ 408-474-1000 (fax)
<http://www.Micrel.com>

Revision History

Revision	Date	Summary of Changes
1.0	6/15/12	Initial Release
1.1	8/17/12	Removed 5V DC Adapter from EVAL Kit. Updated Micrel MDIO Configuration Software installation and usage sections.

Table of Contents

1.0	Introduction	5
2.0	Board Features	5
3.0	Evaluation Kit Contents.....	5
4.0	Hardware Description	6
4.1	Jumper Setting & Definition	7
4.2	Test Point Definition.....	9
4.3	RJ-45 Copper Interface	9
4.4	LED Indicators	9
4.4.1	<i>Single LED Mode</i>	<i>10</i>
4.4.2	<i>Tri-color Dual LED Mode.....</i>	<i>10</i>
4.5	Reduced Gigabit Media Independent Interface (RGMII)	11
4.5.1	<i>RGMII Loop Back.....</i>	<i>11</i>
4.5.2	<i>RGMII Connection to GMAC.....</i>	<i>12</i>
4.6	USB Port	12
5.0	Micrel MdioConfig Software – Installation	13
5.1	MicrelSwitchPhyQATools Installation	13
5.2	USB Driver Installation.....	16
6.0	Micrel MdioConfig Software – Application Program.....	19
6.1	Windows Command Prompt – Command Line program.....	19
6.1.1	<i>Running the program</i>	<i>19</i>
6.1.2	<i>Read/Write access to KSZ9031RNX PHY registers.....</i>	<i>20</i>
6.1.3	<i>Creating and running a script file</i>	<i>21</i>

List of Figures

Figure 1. KSZ9031RNX-EVAL Board.....	6
Figure 2. KSZ9031RNX-EVAL Board – RGMII Loop Back.....	11

List of Tables

Table 1. KSZ9031RNX-EVAL Board – Jumper Definition.....	7
Table 2. Strapping Pin Definitions for KSZ9031RNX-EVAL Board Jumpers.....	8
Table 3. KSZ9031RNX-EVAL Board – Test Point Definition.....	9
Table 4: Single LED Mode – LED Definition.....	10
Table 5: Tri-color Dual LED Mode – LED Definition.....	10
Table 6. RGMII Signals access at series termination / jumper resistor locations.....	12

1.0 Introduction

The KSZ9031RNX is a completely integrated triple speed (10Base-T/100Base-TX/1000Base-T) Ethernet Physical Layer Transceiver for transmission and reception of data over standard CAT-5 unshielded twisted pair (UTP) cable.

The KSZ9031RNX reduces board cost and simplifies board layout by using on-chip termination resistors for the four differential pairs and by integrating a LDO controller to drive a low cost MOSFET to supply the 1.2V core.

On the copper media interface, the KSZ9031RNX can automatically detect and correct for differential pair misplacements and polarity reversals, and correct propagation delays and re-sync timing between the four differential pairs, as specified in the IEEE 802.3 standard for 1000Base-T operation.

The KSZ9031RNX provides the Reduced Gigabit Media Independent Interface (RGMII) for direct connection to RGMII MACs in Gigabit Ethernet Processors and Switches for data transfer at 10/100/1000 Mbps speed.

The KSZ9031RNX Evaluation Board (KSZ9031RNX-EVAL) provides a comprehensive platform to evaluate the KSZ9031RNX features. All KSZ9031RNX configuration pins are accessible either by jumpers, test points or interface connectors.

2.0 Board Features

- Micrel KSZ9031RNX 10Base-T/100Base-TX/1000Base-T Physical Layer Transceiver
- RJ-45 Jack for Ethernet cable interface
- Auto MDI/MDI-X for automatic detection and correction for straight-through and crossover cables
- RGMII Loopback for standalone evaluation
- LED Indicators for link status and activity
- Jumpers to configure strapping pins
- Manual Reset Button for quick reboot after re-configuration of strapping pins
- USB port for MDC/MDIO programming access to KSZ9031RNX PHY registers

3.0 Evaluation Kit Contents

The KSZ9031RNX Evaluation Kit includes the following hardware:

- KSZ9031RNX-EVAL Board (a.k.a. KSZ9031RNX Socket Board)

And a design package with the following collaterals:

- KSZ9031RNX Evaluation-Socket Board Schematic (PDF and OrCAD DSN file)
- KSZ9031RNX Evaluation-Socket Board Gerber & PADS PowerPCB Files
- KSZ9031RNX Evaluation-Socket Board BOM
- KSZ9031RNX Evaluation-Socket Board User's Guide (this document)
- KSZ9031RNX IBIS Model (separate files for 1.8V, 2.5V, and 3.3V VDD I/O voltages)
- Micrel MDIO Configuration Software

4.0 Hardware Description

The KSZ9031RX-EVAL board provides a standalone evaluation platform for the KSZ9031RX Gigabit Ethernet Transceiver. Configuration of the KSZ9031RX is accomplished through on-board jumper selections and/or by PHY register access via the KSZ9031RX MDC/MDIO management pins via the USB port (CN1).

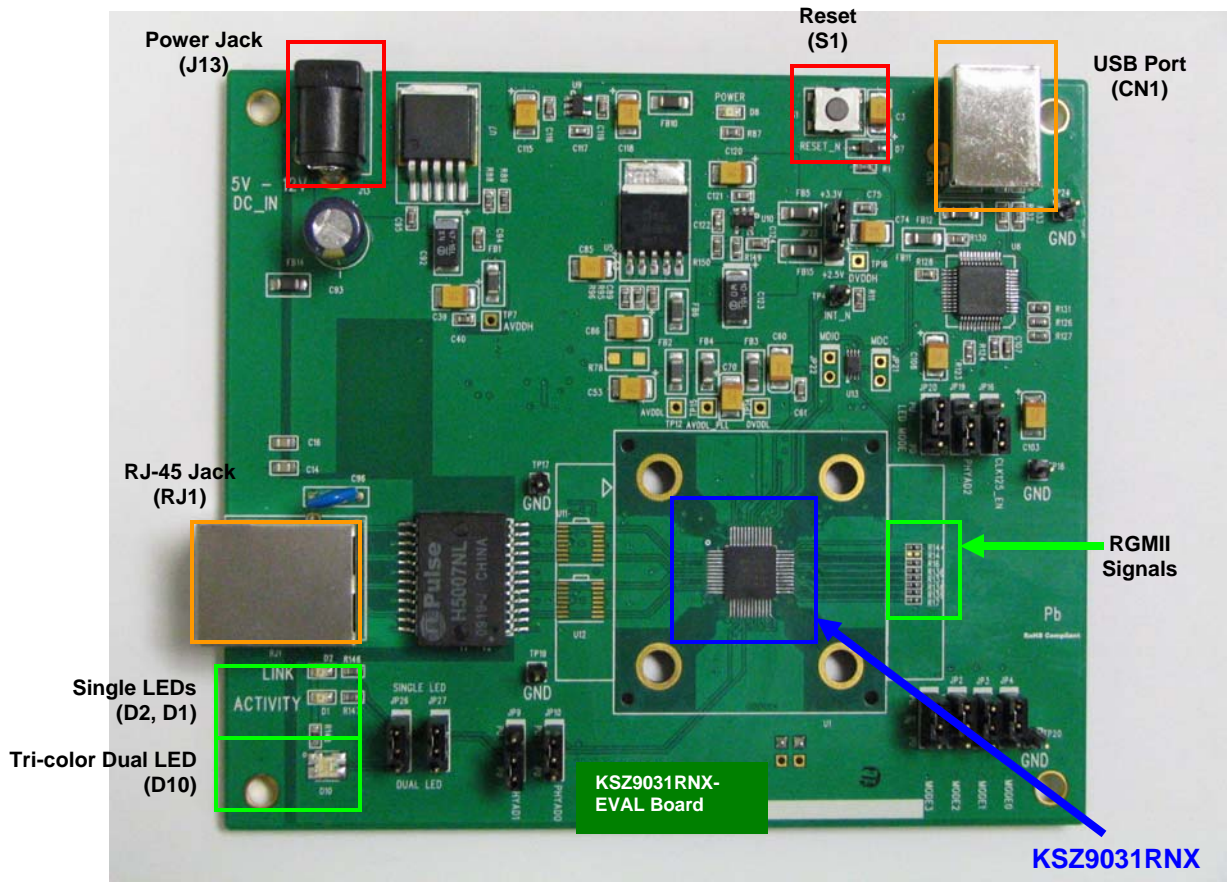

Figure 1. KSZ9031RX-EVAL Board

Features include a RJ-45 Jack for 10/100/1000 Ethernet speed cable connection, programmable LED indicators for reporting link status and activity, and a manual reset button for quick reboot after re-configuration of strapping pins.

On-board, RGMII receive output clock and signals are looped back to RGMII transmit input clock and signals to provide a standalone evaluation platform for the KSZ9031RX device. Optionally, the RGMII loop back path can be opened to allow the RGMII signals to be wired to a Gigabit MAC on another board.

The KSZ9031RX-EVAL board receives power from a DC power jack (J13). Any DC power adapter in the range of 5V to 12V with a current rating of 2 Amp or better can be used.

4.1 Jumper Setting & Definition

At power-up, the KSZ9031RNX device is configured via strapping pins that are set by external pull-up and pull-down resistors. The KSZ9031RNX-EVAL board provides jumpers for the KSZ9031RNX device strap-in settings and for selective board options.

Jumpers allow for quick configuration and re-configuration. To override the current KSZ9031RNX device and board settings, simply select and close the desired jumper setting(s) and toggle the on-board manual reset button (S1) for the new setting(s) to take effect.

The KSZ9031RNX-EVAL board jumper settings are defined in the table below.

Jumper	KSZ9031RNX Pin Name	Setting	Function
<u>KSZ9031RNX Device Strapping Pins</u>			
JP1	MODE3	Close pins (1, 2)	Set MODE3 = 1
		Close pins (2, 3)	Set MODE3 = 0
JP2	MODE2	Close pins (1, 2)	Set MODE2 = 1
		Close pins (2, 3)	Set MODE2 = 0
JP3	MODE1	Close pins (1, 2)	Set MODE1 = 1
		Close pins (2, 3)	Set MODE1 = 0
JP4	MODE0	Close pins (1, 2)	Set MODE0 = 1
		Close pins (2, 3)	Set MODE0 = 0
JP19	PHYAD2	Close pins (1, 2)	Set PHYAD2 = 1
		Close pins (2, 3)	Set PHYAD2 = 0
JP9	PHYAD1	Close pins (1, 2)	Set PHYAD1 = 1
		Close pins (2, 3)	Set PHYAD1 = 0
JP10	PHYAD0	Close pins (1, 2)	Set PHYAD0 = 1
		Close pins (2, 3)	Set PHYAD0 = 0
JP16	CLK125_EN	Close pins (1, 2)	Enable 125 MHz Clock Output
		Close pins (2, 3)	Disable 125 MHz Clock Output
JP20	LED_MODE	Close pins (1, 2)	Select Single LED Mode
		Close pins (2, 3)	Select Tri-color Dual LED Mode
<u>KSZ9031RNX-EVAL Board Settings</u>			
JP26	LED2	Close pins (1, 2)	Use for Single LED Mode
		Close pins (2, 3)	Use for Tri-color Dual LED Mode
JP27	LED1	Close pins (1, 2)	Use for Single LED Mode
		Close pins (2, 3)	Use for Tri-color Dual LED Mode
JP23	DVDDH	Close pins (1, 2)	Select 2.5V for KSZ9031RNX digital I/Os
		Close pins (2, 3)	Select 3.3V for KSZ9031RNX digital I/Os
JP21 ¹	MDC	Close Jumper	Close MDC signal to USB Controller (U8)
		Open Jumper	Open MDC signal to USB Controller (U8)
JP22 ¹	MDIO	Close Jumper	Close MDIO signal to USB Controller (U8)
		Open Jumper	Open MDIO signal to USB Controller (U8)

Note: ¹ JP21 and JP22 connect the MDC/MDIO signals to U8 when U13 is not populated.

Table 1. KSZ9031RNX-EVAL Board – Jumper Definition

The following table lists the strapping pin definitions for the KSZ9031RNX-EVAL board jumpers.

Jumper	Pin	Pin Name	Pin Function														
JP1 JP2 JP3 JP4	27 28 31 32	MODE3 MODE2 MODE1 MODE0	<p>The MODE[3:0] strap-in pins are latched at power-up / reset and are defined as follows:</p> <table border="1"> <thead> <tr> <th>MODE[3:0]</th> <th>Mode</th> </tr> </thead> <tbody> <tr> <td>0100</td> <td>NAND Tree</td> </tr> <tr> <td>0111</td> <td>Chip Power Down</td> </tr> <tr> <td>1100</td> <td>RGMII – advertise 1000Base-T full-duplex only</td> </tr> <tr> <td>1101</td> <td>RGMII – advertise 1000Base-T full and half-duplex only</td> </tr> <tr> <td>1110</td> <td>RGMII – advertise all capabilities (10/100/1000 speed half/full duplex), except 1000Base-T half-duplex</td> </tr> <tr> <td>1111</td> <td>RGMII – advertise all capabilities (10/100/1000 speed half/full duplex)</td> </tr> </tbody> </table> <p>All other MODE[3:0] settings not listed are reserved and are not used by the KSZ9031RNX-EVAL.</p> <p>MODE[3:0] = 1111 is the normal RGMII setting and is set as the default for the board.</p>	MODE[3:0]	Mode	0100	NAND Tree	0111	Chip Power Down	1100	RGMII – advertise 1000Base-T full-duplex only	1101	RGMII – advertise 1000Base-T full and half-duplex only	1110	RGMII – advertise all capabilities (10/100/1000 speed half/full duplex), except 1000Base-T half-duplex	1111	RGMII – advertise all capabilities (10/100/1000 speed half/full duplex)
MODE[3:0]	Mode																
0100	NAND Tree																
0111	Chip Power Down																
1100	RGMII – advertise 1000Base-T full-duplex only																
1101	RGMII – advertise 1000Base-T full and half-duplex only																
1110	RGMII – advertise all capabilities (10/100/1000 speed half/full duplex), except 1000Base-T half-duplex																
1111	RGMII – advertise all capabilities (10/100/1000 speed half/full duplex)																
JP19 JP9 JP10	35 15 17	PHYAD2 PHYAD1 PHYAD0	<p>The PHY Address is latched at power-up / reset and is configurable to any value from 0 to 7. PHY Address bits [4:3] are always set to '00'.</p> <p>PHYAD[2:0] = 001 is set as the default for the board.</p>														
JP16	33	CLK125_EN	<p>CLK125_EN is latched at power-up / reset and is defined as follows:</p> <p style="padding-left: 40px;">Pull-up (1) = Enable 125MHz Clock Output Pull-down (0) = Disable 125MHz Clock Output</p> <p>Pin 41 (CLK125_NDO) provides the 125MHz reference clock output option for use by the MAC.</p> <p>CLK125_EN = 0 is set as the default for the board.</p>														
JP20	41	LED_MODE	<p>LED_MODE is latched at power-up / reset and is defined as follows:</p> <p style="padding-left: 40px;">Pull-up (1) = Single LED Mode Pull-down (0) = Tri-color Dual LED Mode</p> <p>LED_MODE = 1 is set as the default for the board.</p>														

Table 2. Strapping Pin Definitions for KSZ9031RNX-EVAL Board Jumpers

4.2 Test Point Definition

The KSZ9031RNX-EVAL board has 16 usable test points, as defined in the following table.

Test Point	Definition
TP4	Interrupt Signal (KSZ9031RNX pin 38) with 4.7K external pull-up
TP7	AVDDH voltage – KSZ9031RNX power pins
TP12	AVDDL voltage – KSZ9031RNX power pins
TP14	DVDDL – KSZ9031RNX power pins
TP15	AVDDL_PLL – KSZ9031RNX power pin
TP16	DVDDH – KSZ9031RNX power pins
TP17	Signal Ground
TP18	Signal Ground
TP19	Signal Ground
TP20	Signal Ground
TP24	Signal Ground
TP33	Exposed ground connection to KSZ9031RNX paddle ground (bottom of chip); Test point is located on solder side of PCB.
TP34	End point for board trace delay for RGMII RX_CLK output clock; Refer to KSZ9031RNX-EVAL Board Schematic for more details.
TP35	1.8ns (10000 mils) board trace delay for RGMII RX_CLK output clock, starting from resistor R144; Refer to KSZ9031RNX-EVAL Board Schematic for more details.
TP36-TP37	450ps (2500 mils) board trace delay for RGMII RX_CLK output clock; Refer to KSZ9031RNX-EVAL Board Schematic for more details.

Table 3. KSZ9031RNX-EVAL Board – Test Point Definition

4.3 RJ-45 Copper Interface

The RJ-45 copper interface (RJ1) connects to standard unshielded twisted pair (UTP) CAT-5 Ethernet cable to interface with 10Base-T/100Base-TX/1000Base-T network devices.

The KSZ9031RNX copper media interface can automatically detect and correct for differential pair misplacements and polarity reversals, and correct propagation delays and re-sync timing between the four differential pairs, as specified in the IEEE 802.3 standard for 1000Base-T operation.

Auto MDI/MDI-X is supported for automatic detection and correction for straight and crossover cables when interfacing to link partners with fixed MDI or MDI-X setting.

4.4 LED Indicators

The KSZ9031RNX device provides two programmable LED output pins, LED2 (pin 15) and LED1 (pin 17). On the KSZ9031RNX-EVAL board, these two LED pins are connected to two sets of LEDs to support two LED configurations: Single LED mode and Tri-color Dual LED mode.

4.4.1 Single LED Mode

To enable Single LED mode,

- Close pins (1, 2) of jumpers JP26 and JP27 to select D2 and D1, respectively for the single LEDs.
- Close pins (1, 2) of jumper JP20 to set the LED_MODE strap-in for Single LED mode.
- Power-up the board.

After board power-up, the on-board D2 and D1 LEDs are defined as follows:

LED	LED Definition	Link / Activity
D2	OFF	Link off
	Green – ON	Link on (any speed)
D1	OFF	No Activity
	Green – Blinking	Activity (RX, TX)

Table 4: Single LED Mode – LED Definition

4.4.2 Tri-color Dual LED Mode

To enable Tri-color Dual LED mode,

- Close pins (2, 3) of jumpers JP26 and JP27 to select D10 for the tri-color dual LED.
- Close pins (2, 3) of jumper JP20 to set the LED_MODE strap-in for Tri-color Dual LED mode.
- Power-up the board.

After board power-up, the on-board D10 LED is defined as follows:

LED: D10	Link / Activity
OFF	Link off
Green – ON	1000Mbps Link / No Activity
Green – Blinking	1000Mbps Link / Activity (RX, TX)
Red – ON	100Mbps Link / No Activity
Red – Blinking	100Mbps Link / Activity (RX, TX)
Orange – ON	10Mbps Link / No Activity
Orange – Blinking	10Mbps Link / Activity (RX, TX)

Table 5: Tri-color Dual LED Mode – LED Definition

4.5 Reduced Gigabit Media Independent Interface (RGMII)

The KSZ9031RNX-EVAL board provides open access to the KSZ9031RNX device's RGMII signals, and enables the RGMII signals to be wired for the following two usages:

- RGMII Loop Back
- RGMII Connection to GMAC

4.5.1 RGMII Loop Back

The KSZ9031RNX-EVAL board is shipped with the RGMII signals configured for RGMII Loop Back. Resistors [R14, R16, R136-R139] are populated to connect the RGMII output clock and signals to their respective RGMII input clock and signals, thru resistors [R18, R17, R143, R142, R141, R140], respectively. Refer to KSZ9031RNX-EVAL Board Schematic for details.

RGMII Loop Back enables the KSZ9031RNX device to operate as a standalone evaluation platform without the need of an external GMAC. Ethernet traffic from the link partner (Spirent SmartBits 6000B in the following figure) are received by the KSZ9031RNX device, looped back externally via RGMII pins, and transmitted back to the link partner.

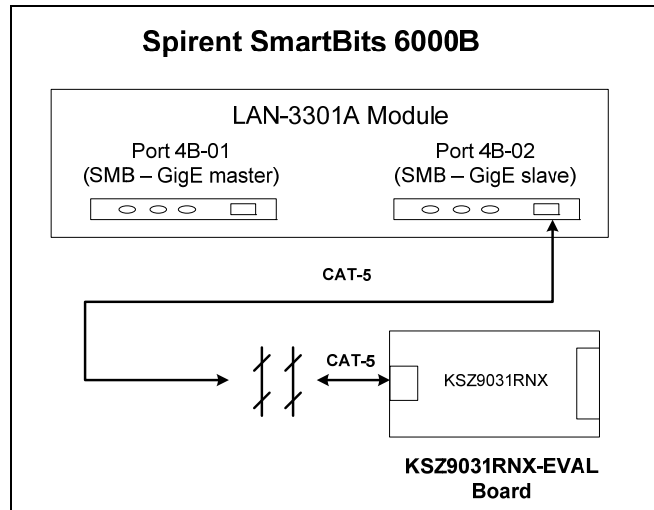

Figure 2. KSZ9031RNX-EVAL Board – RGMII Loop Back

RGMII Loop Back is supported for 1000Base-T and 100Base-TX only. 10Base-T requires a MAC due to preamble consumption, and therefore is not supported.

4.5.2 RGMII Connection to GMAC

The KSZ9031RNX-EVAL board exposes the RGMII signals at the following series termination (49.9 Ohm) / jumper (0 Ohm) resistor locations, as indicated in the following table.

Resistor (PCB location)	KSZ9031RNX-EVAL Signal Name	RGMII Signal Name (per spec)
R14 left pad (PCB – top side)	RX_CLK	RXC
R16 left pad (PCB – top side)	RX_DV	RX_CTL
R136 left pad (PCB – top side)	RXD0	RXD0
R137 left pad (PCB – top side)	RXD1	RXD1
R138 left pad (PCB – top side)	RXD2	RXD2
R139 left pad (PCB – top side)	RXD3	RXD3
R18 top pad (PCB – bottom side)	GTX_CLK	TXC
R17 left pad (PCB – top side)	TX_EN	TX_CTL
R143 top pad (PCB – bottom side)	TXD0	TXD0
R142 top pad (PCB – bottom side)	TXD1	TXD1
R141 top pad (PCB – bottom side)	TXD2	TXD2
R140 top pad (PCB – bottom side)	TXD3	TXD3

Table 6. RGMII Signals access at series termination / jumper resistor locations

Resistors [R14, R16, R136-R139] for the RGMII output clock and signals and the corresponding resistors [R18, R17, R143, R142, R141, R140] for the RGMII input clock and signals can be removed to open the RGMII Loop Back path and allow the RGMII signals (in the above table) to be wired to a GMAC on another board for evaluation and testing.

4.6 USB Port

The USB port (CN1) provides programming access to the KSZ9031RNX device's PHY registers through its MDC/MDIO management pins.

See following software section for PHY register access.

5.0 Micrel MdioConfig Software – Installation

The Micrel MDIO Configuration Software (**MdioConfig.exe** program) runs on a PC/NOTEBOOK with the Window XP or 7 Operating System. It communicates with the KSZ9031RNX-EVAL board via USB to provide programming access to the KSZ9031RNX PHY registers.

The Micrel software is provided in a Microsoft Windows Installer installation package file (*.msi file) with the following file name.

MicrelSwitchPhyQATools_x.xx.msi // where x.xx is the release version number

5.1 MicrelSwitchPhyQATools Installation

Before running the **MicrelSwitchPhyQATools** installation, make sure previously installed version of the **MicrelSwitchPhyQATools** software has been removed and the USB cable to the KSZ9031RNX-EVAL board is unplugged.

To unpack the **MicrelSwitchPhyQATools_x.xx.msi** file and start the installation, double click on the file name from Windows Explorer, and proceed with the following steps:

1. At the “**Welcome**” screen, press the **Next>** button.

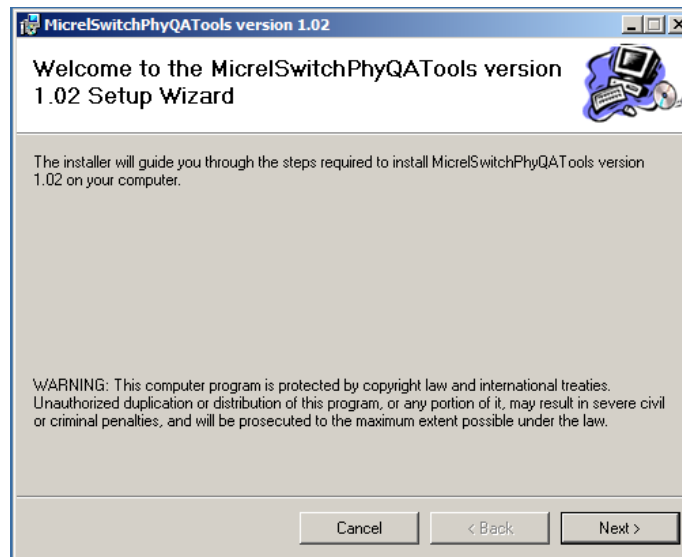

2. At the “**Select Installation Folder**” screen,
 - a. Select the folder for the software installation (c:\Micrel\QATools\ is the default installation folder).
 - b. Press the **Next>** button.

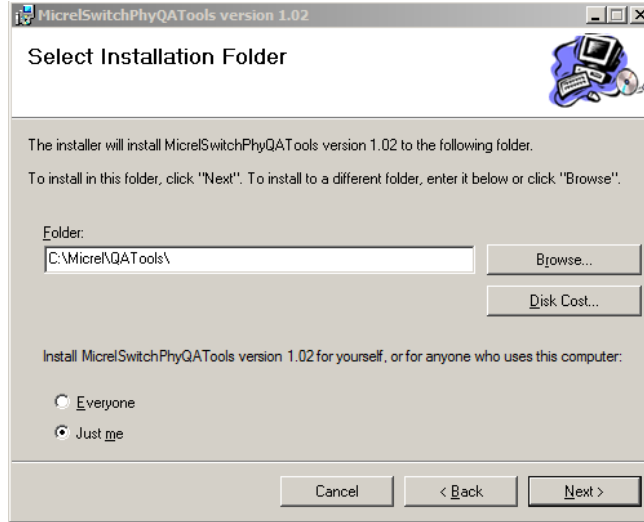

3. At the “**Confirm Installation**” screen,
 - a. Press the **Next>** button for the installation to proceed.
 - b. Wait a few seconds for the installation to finish.

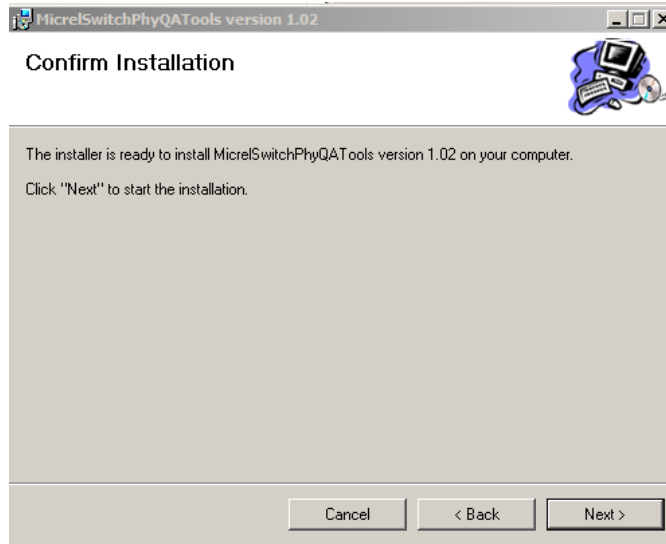

4. When the installation is finished, the “**Installation Complete**” screen is returned. Press the **Close**> button to exit.

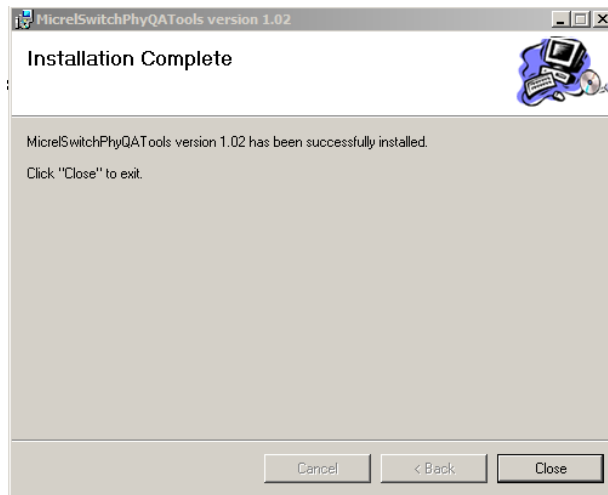

After the **MicrelSwitchPhyQATools** installation, an installation folder (c:\Micrel\QATools) is the default installation folder) is created containing the **mdioConfig** application program and software drivers for the KSZ9031RNX-EVAL board's USB port.

5.2 USB Driver Installation

Before installing the USB driver, complete the **MicrelSwitchPhyQATools** software installation in the previous section to extract the USB driver from the **MicrelSwitchPhyQATools_x.xx.msi** installation file and have it copied to the created installation folder.

Power-up the KSZ9031RNX-EVAL Board and connect USB cable from board to PC/NOTEBOOK with the Windows XP or 7 Operating System to initiate the USB driver installation, and proceed with the following steps:

1. Windows XP detects the KSZ9031RNX-EVAL board's USB device. At the **"Welcome to the Found New Hardware Wizard"** screen,
 - a. Select **"No, not this time"**.
 - b. Press the **Next>** button.

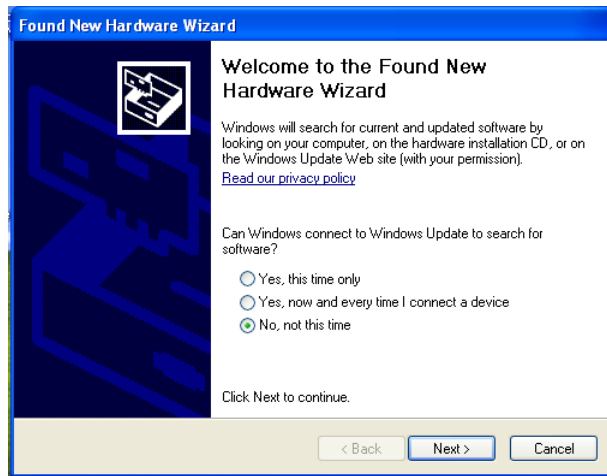

2. At the **"... install software for:"** screen,
 - a. Select **"Install from a list or specific location (Advanced)"**.
 - b. Press the **Next>** button.

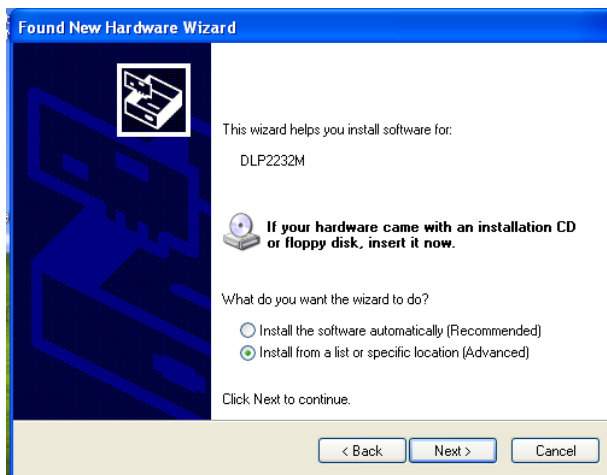

3. At the “**Please choose your search and installation options**” screen,
 - a. Select “**Include this location in the search:**”
 - b. Press the **Browse** button and navigate to and select the USB driver directory (**C:\Micrel\QATools\D2XXDriver\CDM 2.02.04 WHQL Certified** is the USB driver directory for the default installation folder).
 - c. Press the **Next>** button for the USB driver installation to proceed.
 - d. Wait for the USB driver installation to finish.

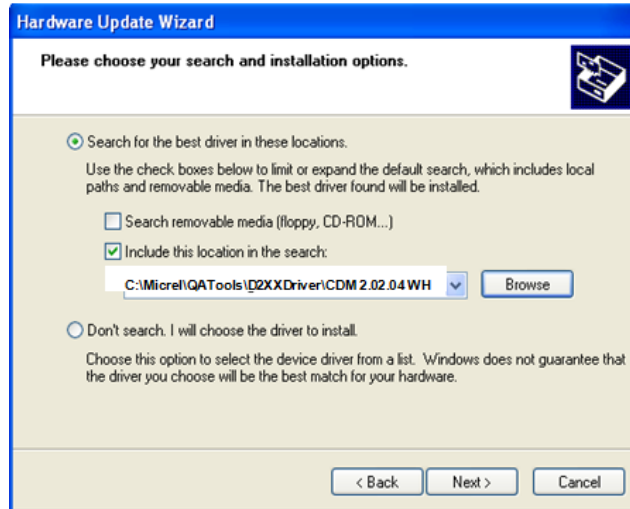

4. At the “**Completing the Found New Hardware Wizard**” screen, press the **Finish** button to close the wizard and exit.

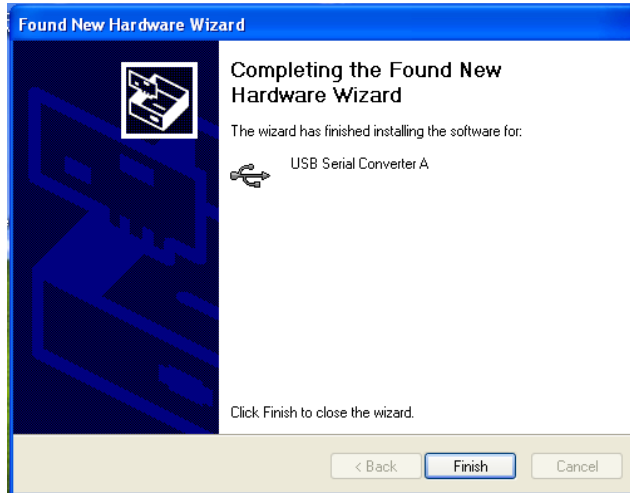

5. After the USB driver installation, verify the USB driver is installed.
 - a. Go to the **Windows System Properties** box (select the System icon under Windows Start Menu -> Settings -> Control Panel).

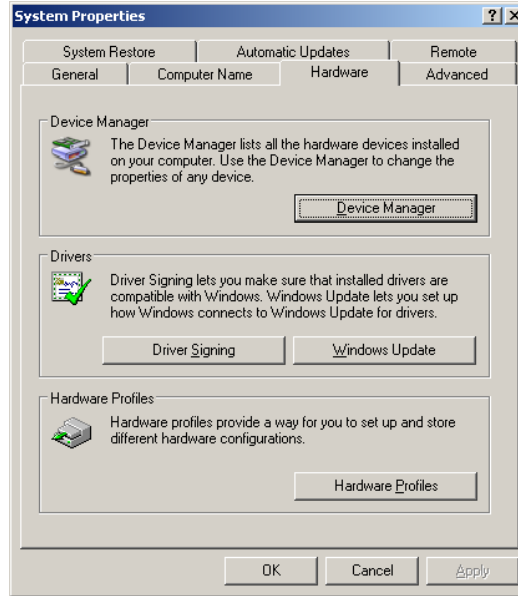

- b. Press the **Device Manager** button
 - c. Scroll down to the end of Universal Serial Bus controllers to verify “**USB Serial Converter A**” and “**USB Serial Converter B**” are installed.

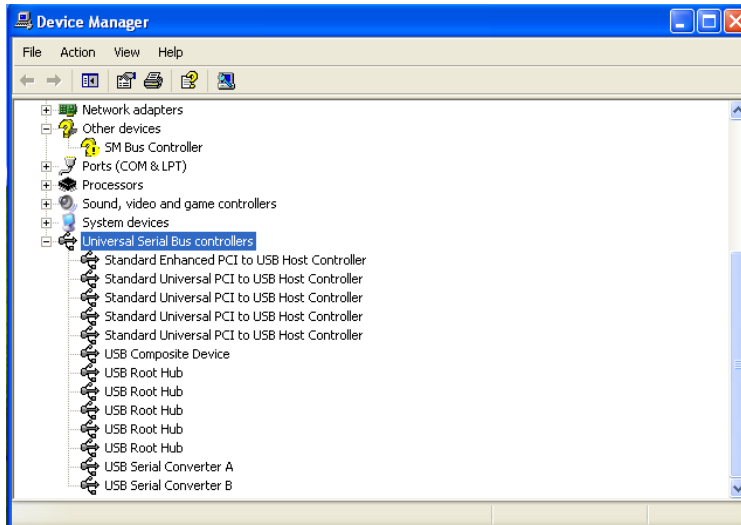

6.0 Micrel MdioConfig Software – Application Program

The **Micrel MdioConfig** application program resides in the software installation folder created in the previous section (c:\Micrel\QATools\ is the default installation folder). The following application program in the folder will be used to provide read/write access to the KSZ9031RNX PHY registers.

- **mdioConfig.exe** // Windows Command Prompt program

6.1 Windows Command Prompt – Command Line program

The **mdioConfig.exe** program is a command line interface program.

6.1.1 Running the program

The **mdioConfig.exe** program is executed from a Windows Command Prompt. Open a Windows Command Prompt (select the Command Prompt under Windows Start Menu -> Programs -> Accessories) and go to the **mdioConfig.exe** program directory (c:\Micrel\QATools\ is the program directory for the default installation folder), as shown in the following figure.

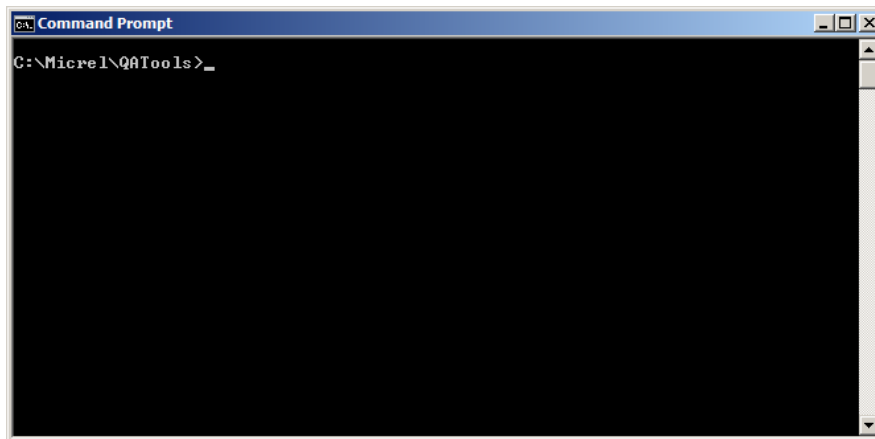

mdioConfig.exe Program – Windows Command Prompt

The **mdioConfig.exe** program is started by typing the **mdioConfig.exe** program name at the Windows Command Prompt and pressing the <ENTER> key.

After pressing the <ENTER> key at the previous screen, the program will automatically detect and set the KSZ9031RNX PHY address for the programming session, and then display the command line prompt, “->”, as shown in the following figure.

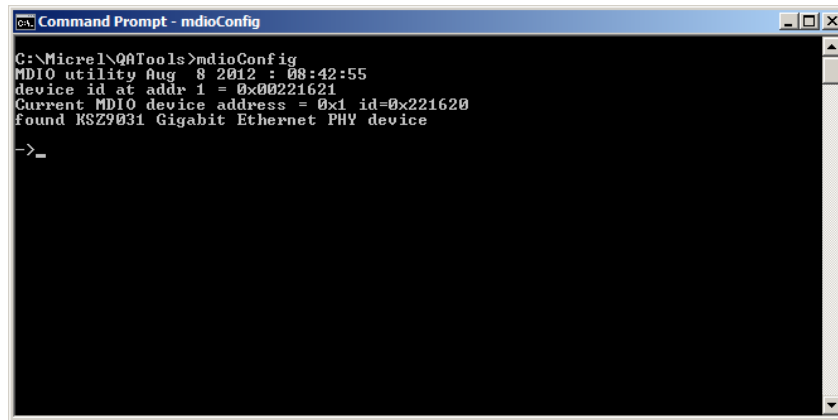

```
C:\Micrel\Q0Tools>mdioConfig
MDIO utility Aug 8 2012 : 00:42:55
device id at addr 1 = 0x00221621
Current MDIO device address = 0x1 id=0x221620
found KSZ9031 Gigabit Ethernet PHY device
->
```

[mdioConfig.exe](#) Program – Command Line Prompt

6.1.2 Read/Write access to KSZ9031RNX PHY registers

Direct register read and direct register write can be used to check and/or update individual PHY register setting, as needed. The following are the commands and parameters:

Direct Register Read

r [register address (hex)]

r 0	// Read PHY register 0h
r 1	// Read PHY register 1h
r 2	// Read PHY register 2h
r 3	// Read PHY register 3h

Direct Register Write

w [register address (hex)] [written value (hex)]

w 0 8000	// Write PHY register 0h with value 0x8000h
w 0 2500	// Write PHY register 0h with value 0x2500h

The following screen shows the execution of the direct register read/write commands.

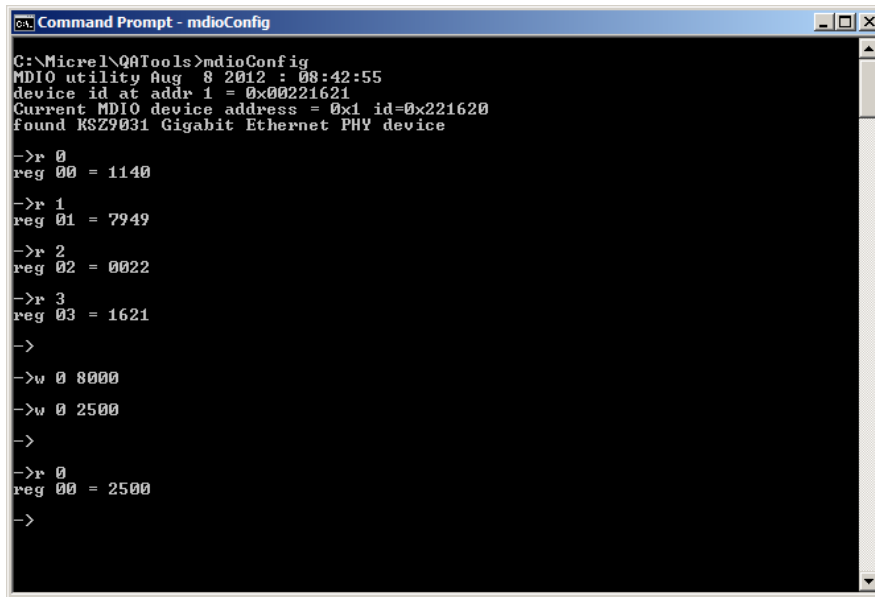

```
C:\Micrel\QATools>mdioConfig
MDIO utility Aug 8 2012 : 08:42:55
device id at addr 1 = 0x00221621
Current MDIO device address = 0x1 id=0x221620
Found KSZ9031 Gigabit Ethernet PHY device

->r 0
reg 00 = 1140

->r 1
reg 01 = 7949

->r 2
reg 02 = 0022

->r 3
reg 03 = 1621

->

->w 0 8000

->w 0 2500

->

->r 0
reg 00 = 2500

->
```

mdioConfig.exe Program – Direct Register Read / Write Examples

6.1.3 Creating and running a script file

A group of single command lines can be put in a text file (*.txt) to produce a PHY configuration script file. The script file can then be run to program a set of PHY registers.

The script file format is as follow:

- Lines starting with the “#” symbol are ignored and can be used to provide comments
- Empty lines with just the <ENTER> key are ignored
- Each command line for register read or register write is entered on a separate line and followed by the <ENTER> key

For example, the following is the content of a script file called “**sample.txt**”.

```
# Sample script file to read PHY registers 0-3 and write to PHY registers 0 twice
#

r 0
r 1
r 2
r 3
w 0 8000
w 0 2500
```

Copy the script file into the software installation folder created earlier in section 5.0 (c:\Micrel\QATools\ is the default installation folder).

Type the following script file command line and press the **ENTER** key to execute the script file.

run sample.txt