

**Dual common source  
Fast Trench + Field Stop IGBT®  
Power Module**

**$V_{CES} = 1200V$   
 $I_C = 50A @ T_c = 80^\circ C$**

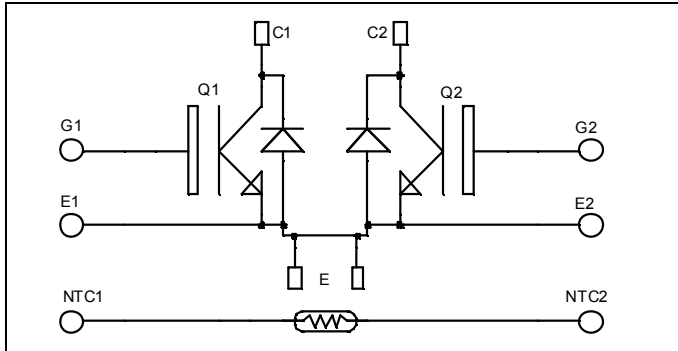

### Application

- AC Switches
- Switched Mode Power Supplies
- Uninterruptible Power Supplies

### Features

- Fast Trench + Field Stop IGBT® Technology
  - Low voltage drop
  - Low tail current
  - Switching frequency up to 20 kHz
  - Soft recovery parallel diodes
  - Low diode VF
  - Low leakage current
  - Avalanche energy rated
  - RBSOA and SCSOA rated
- Kelvin emitter for easy drive
- Very low stray inductance
  - Symmetrical design
  - Lead frames for power connections
- High level of integration
- Internal thermistor for temperature monitoring

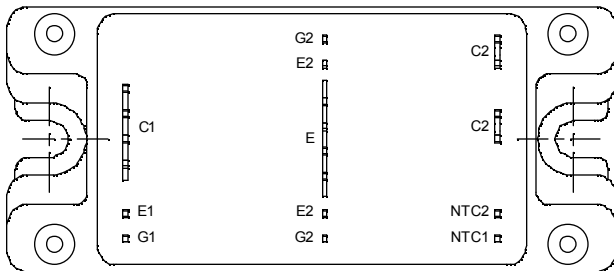

### Benefits

- Stable temperature behavior
- Very rugged
- Solderable terminals for easy PCB mounting
- Direct mounting to heatsink (isolated package)
- Low junction to case thermal resistance
- Easy paralleling due to positive TC of VCESat
- Low profile
- RoHS Compliant

### Absolute maximum ratings

Symbol	Parameter	Max ratings	Unit
$V_{CES}$	Collector - Emitter Breakdown Voltage	1200	V
$I_C$	Continuous Collector Current	$T_c = 25^\circ C$	75
		$T_c = 80^\circ C$	50
$I_{CM}$	Pulsed Collector Current	$T_c = 25^\circ C$	100
$V_{GE}$	Gate - Emitter Voltage	$\pm 20$	V
$P_D$	Maximum Power Dissipation	$T_c = 25^\circ C$	277
RBSOA	Reverse Bias Safe Operating Area	$T_j = 125^\circ C$	100A @ 1150V

**CAUTION:** These Devices are sensitive to Electrostatic Discharge. Proper Handling Procedures Should Be Followed. See application note APT0502 on [www.microsemi.com](http://www.microsemi.com)

All ratings @  $T_j = 25^\circ\text{C}$  unless otherwise specified

**Electrical Characteristics**

Symbol	Characteristic	Test Conditions	Min	Typ	Max	Unit
$I_{CES}$	Zero Gate Voltage Collector Current	$V_{GE} = 0\text{V}, V_{CE} = 1200\text{V}$			250	$\mu\text{A}$
$V_{CE(sat)}$	Collector Emitter Saturation Voltage	$V_{GE} = 15\text{V}$ $I_C = 50\text{A}$	$T_j = 25^\circ\text{C}$	1.7	2.1	V
			$T_j = 125^\circ\text{C}$	2.0		
$V_{GE(th)}$	Gate Threshold Voltage	$V_{GE} = V_{CE}, I_C = 2\text{mA}$	5.0	5.8	6.5	V
$I_{GES}$	Gate – Emitter Leakage Current	$V_{GE} = 20\text{V}, V_{CE} = 0\text{V}$			400	nA

**Dynamic Characteristics**

Symbol	Characteristic	Test Conditions	Min	Typ	Max	Unit
$C_{ies}$	Input Capacitance	$V_{GE} = 0\text{V}$		3600		pF
$C_{oes}$	Output Capacitance	$V_{CE} = 25\text{V}$		190		
$C_{res}$	Reverse Transfer Capacitance	$f = 1\text{MHz}$		160		
$T_{d(on)}$	Turn-on Delay Time	Inductive Switching ( $25^\circ\text{C}$ )		90		ns
$T_r$	Rise Time	$V_{GE} = 15\text{V}$		30		
$T_{d(off)}$	Turn-off Delay Time	$V_{Bus} = 600\text{V}$		420		
$T_f$	Fall Time	$I_C = 50\text{A}$ $R_G = 18\ \Omega$		70		
$T_{d(on)}$	Turn-on Delay Time	Inductive Switching ( $125^\circ\text{C}$ )		90		ns
$T_r$	Rise Time	$V_{GE} = 15\text{V}$		50		
$T_{d(off)}$	Turn-off Delay Time	$V_{Bus} = 600\text{V}$		520		
$T_f$	Fall Time	$I_C = 50\text{A}$ $R_G = 18\ \Omega$		90		
$E_{on}$	Turn-on Switching Energy	$V_{GE} = 15\text{V}$ $V_{Bus} = 600\text{V}$	$T_j = 125^\circ\text{C}$	5		mJ
$E_{off}$	Turn-off Switching Energy	$I_C = 50\text{A}$ $R_G = 18\ \Omega$	$T_j = 125^\circ\text{C}$	5.5		

**Reverse diode ratings and characteristics**

Symbol	Characteristic	Test Conditions	Min	Typ	Max	Unit
$V_{RRM}$	Maximum Peak Repetitive Reverse Voltage		1200			V
$I_{RM}$	Maximum Reverse Leakage Current	$V_R = 1200\text{V}$	$T_j = 25^\circ\text{C}$		250	$\mu\text{A}$
			$T_j = 125^\circ\text{C}$		500	
$I_F$	DC Forward Current		$T_c = 80^\circ\text{C}$	50		A
$V_F$	Diode Forward Voltage	$I_F = 50\text{A}$	$T_j = 25^\circ\text{C}$	1.4	1.9	V
			$T_j = 125^\circ\text{C}$	1.3		
$t_{rr}$	Reverse Recovery Time	$I_F = 50\text{A}$ $V_R = 600\text{V}$ $di/dt = 2000\text{A}/\mu\text{s}$	$T_j = 25^\circ\text{C}$	150		ns
			$T_j = 125^\circ\text{C}$	250		
$Q_{rr}$	Reverse Recovery Charge		$T_j = 25^\circ\text{C}$	4.5		$\mu\text{C}$
			$T_j = 125^\circ\text{C}$	9		
$E_r$	Reverse Recovery Energy		$T_j = 25^\circ\text{C}$	2.1		mJ
			$T_j = 125^\circ\text{C}$	4.2		

**Temperature sensor NTC** (see application note APT0406 on [www.microsemi.com](http://www.microsemi.com) for more information).

Symbol	Characteristic	Min	Typ	Max	Unit
R <sub>25</sub>	Resistance @ 25°C		50		kΩ
B <sub>25/85</sub>	T <sub>25</sub> = 298.15 K		3952		K

$$R_T = \frac{R_{25}}{\exp\left[B_{25/85}\left(\frac{1}{T_{25}} - \frac{1}{T}\right)\right]}$$

T: Thermistor temperature  
 R<sub>T</sub>: Thermistor value at T

## Thermal and package characteristics

Symbol	Characteristic	Min	Typ	Max	Unit		
R <sub>thJC</sub>	Junction to Case Thermal Resistance	IGBT		0.45	°C/W		
		Diode		0.58			
V <sub>ISOL</sub>	RMS Isolation Voltage, any terminal to case t=1 min, I <sub>isol</sub> <1mA, 50/60Hz	2500			V		
T <sub>J</sub>	Operating junction temperature range	-40		150	°C		
T <sub>STG</sub>	Storage Temperature Range	-40		125			
T <sub>C</sub>	Operating Case Temperature	-40		100			
Torque	Mounting torque		To Heatsink	M5	2.5	4.7	N.m
Wt	Package Weight					160	g

## SP4 Package outline (dimensions in mm)

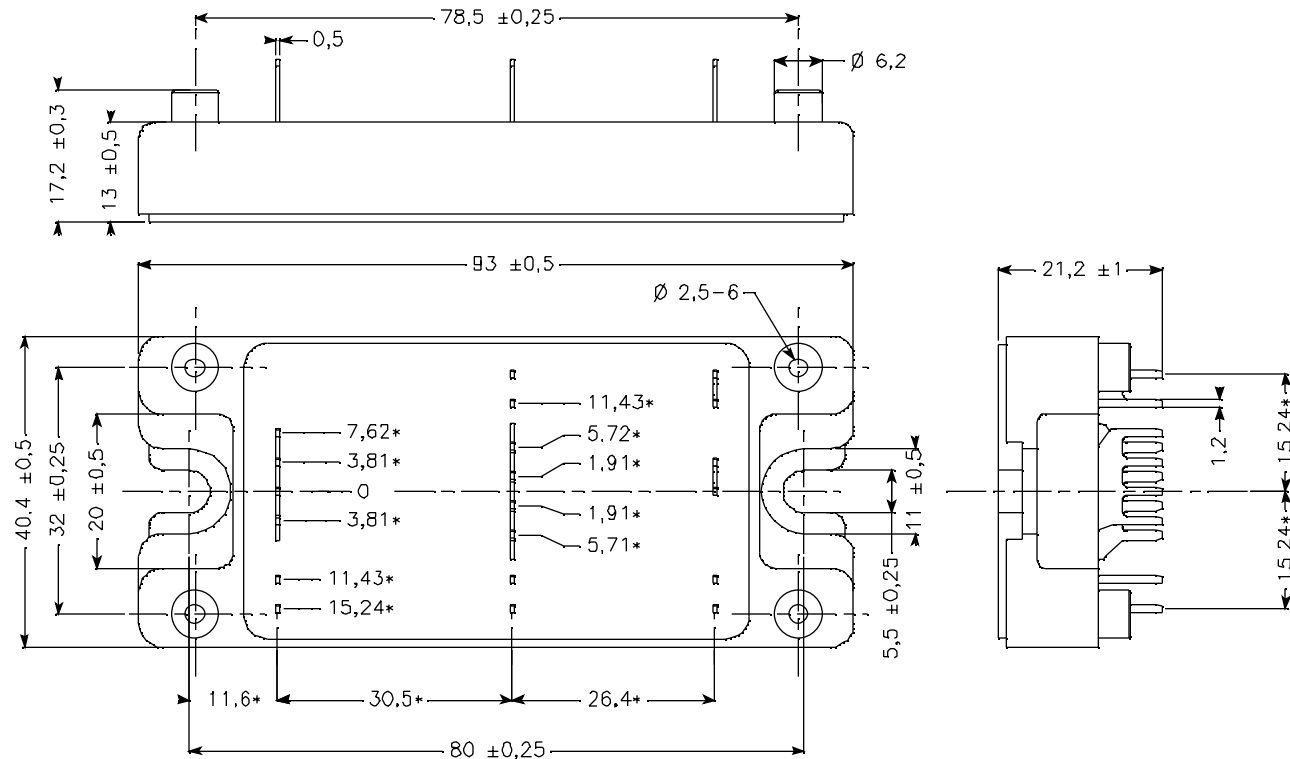

ALL DIMENSIONS MARKED "\*" ARE TOLERANCED AS:  $\pm 0.1$

See application note APT0501 - Mounting Instructions for SP4 Power Modules on [www.microsemi.com](http://www.microsemi.com)

## Typical Performance Curve

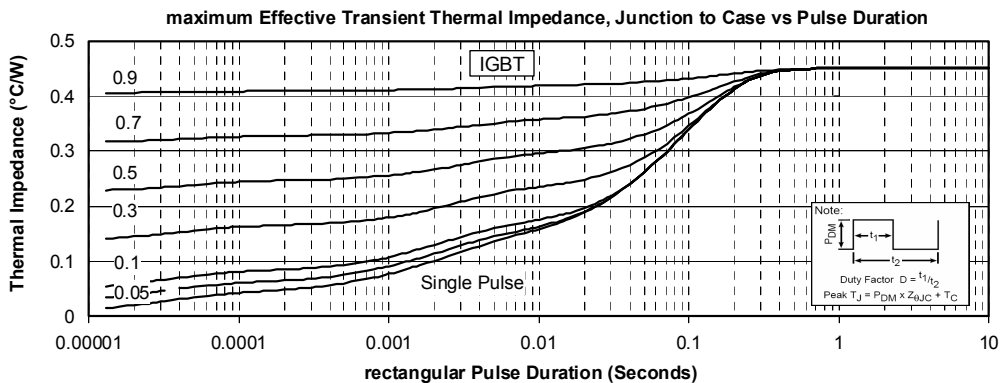
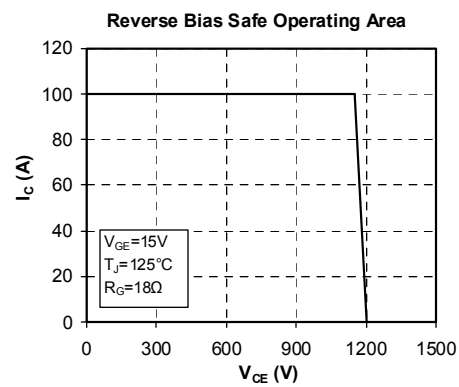
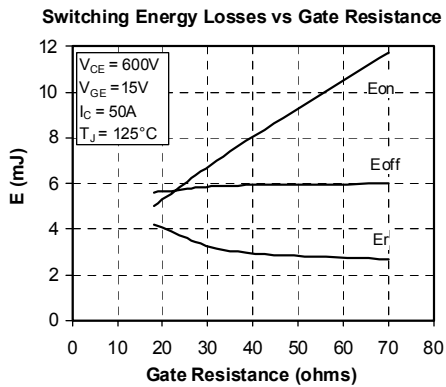
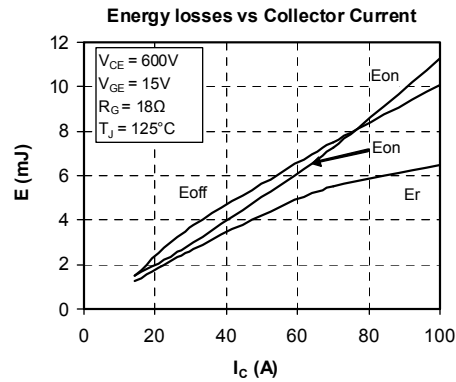
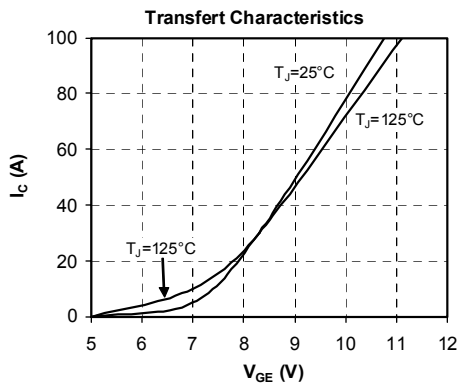
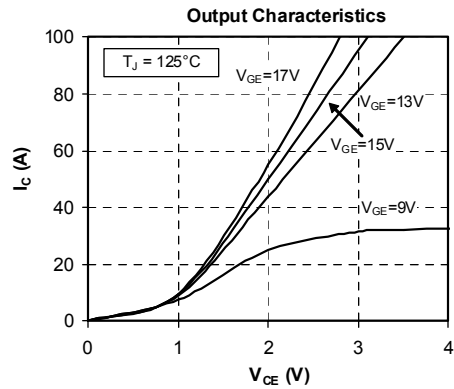
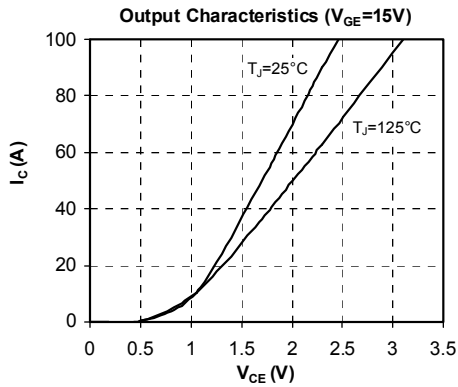

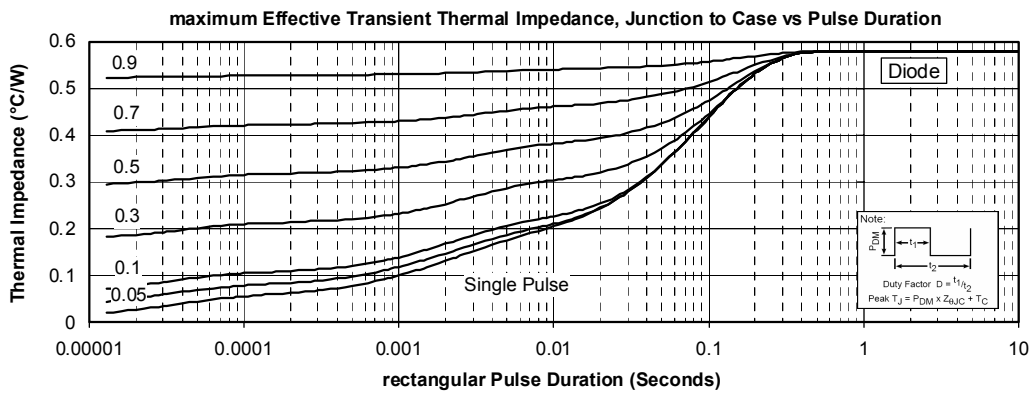
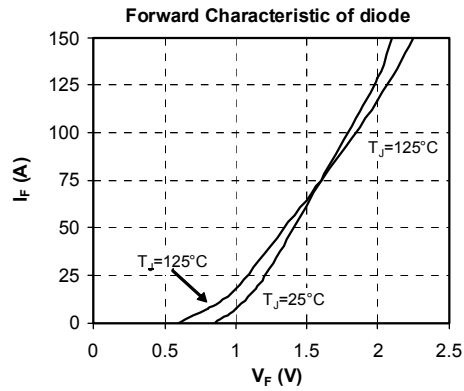
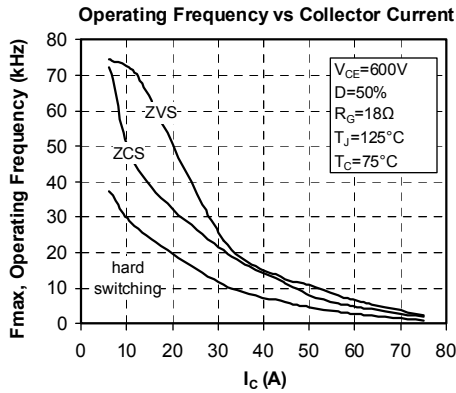

Microsemi reserves the right to change, without notice, the specifications and information contained herein

Microsemi's products are covered by one or more of U.S. patents 4,895,810 5,045,903 5,089,434 5,182,234 5,019,522 5,262,336 6,503,786 5,256,583 4,748,103 5,283,202 5,231,474 5,434,095 5,528,058 and foreign patents. U.S. and Foreign patents pending. All Rights Reserved.