

TJA1022

Dual LIN 2.2/SAE J2602 transceiver

Rev. 1 — 30 March 2012

Product data sheet

1. General description

The TJA1022 is a dual LIN transceiver that provides the interface between a Local Interconnect Network (LIN) master/slave protocol controller and the physical bus in a LIN network. It is primarily intended for in-vehicle subnetworks using baud rates up to 20 kBd and is LIN 2.0, LIN 2.1, LIN 2.2 and SAE J2602 compliant. The TJA1022 is pin compatible with the TJA1020, TJA1021 and TJA1027 (see [Section 18](#)). The TJA1022 and TJA1027 are also software compatible.

The transmit data streams generated by the protocol controller are converted by the TJA1022 into optimized bus signals shaped to minimize ElectroMagnetic Emissions (EME). The LIN bus output pins are pulled HIGH via internal termination resistors. For a master application, an external resistor in series with a diode should be connected between pin V_{BAT} and each of the LIN pins. The receivers detect receive data streams on the LIN bus input pins and transfer them via pins RXD1 and RXD2 to the microcontroller.

Power consumption is very low when both transceivers are in Sleep mode. However, the TJA1022 can still be woken up via pins LIN1/LIN2 and SLP1_N/SLP2_N.

2. Features and benefits

2.1 General

- Two LIN transceivers in a single package
- LIN 2.0, LIN 2.1, LIN 2.2 and SAE J2602 compliant
- Baud rate up to 20 kBd
- Very low ElectroMagnetic Emissions (EME)
- Very low current consumption in Sleep mode with remote LIN wake-up
- Input levels compatible with 3.3 V and 5 V devices
- Integrated termination resistors for LIN slave applications
- Passive behavior in unpowered state
- Operational during cranking pulse: full operation from 5 V upwards
- Undervoltage detection
- K-line compatible
- Available in SO14 and HVSON14 packages
- Leadless HVSON14 package (3.0 mm × 4.5 mm) with improved Automated Optical Inspection (AOI) capability
- Dark green product (halogen free and Restriction of Hazardous Substances (RoHS) compliant)
- Pin-compatible with the TJA1020, TJA1021 and TJA1027 (see [Section 18](#))
- Software-compatible with the TJA1027



2.2 Protection

- Very high ElectroMagnetic Immunity (EMI)
- Very high ESD robustness: ±8 kV according to IEC 61000-4-2 for pins LIN1, LIN2 and V_{BAT}
- Bus terminal and battery pin protected against transients in the automotive environment (ISO 7637)
- Bus terminal short-circuit proof to battery and ground
- Thermally protected
- Initial TXD dominant check when switching to Normal mode
- TXD dominant time-out function

3. Quick reference data

Table 1. Quick reference data

Symbol	Parameter	Conditions	Min	Typ	Max	Unit
V_{BAT}	battery supply voltage	limiting values	-0.3	-	+42	V
		operating range	5	-	18	V
I_{BAT}	battery supply current	Sleep mode (both channels); bus recessive (both channels); $V_{LINx} = V_{BAT}$; $V_{SLPx_N} = 0$ V	2.5	7	10	μ A
		Standby mode (both channels); bus recessive (both channels); $V_{LINx} = V_{BAT}$; $V_{SLPx_N} = 0$ V	2.5	7	10	μ A
		Normal mode (both channels); bus recessive (both channels); $V_{TXDx} = 5$ V; $V_{LINx} = V_{BAT}$; $V_{SLPx_N} = 5$ V	300	1600	3200	μ A
V_{LIN}	voltage on pin LIN	pins LIN1 and LIN2; limiting value; with respect to GND and V_{BAT}	-42	-	+42	V
V_{ESD}	electrostatic discharge voltage	on pins LIN1, LIN2 and V_{BAT} ; according to IEC 61000-4-2	-8	-	+8	kV
T_{vj}	virtual junction temperature		-40	-	+150	$^{\circ}$ C

4. Ordering information

Table 2. Ordering information

Type number	Package		Version
	Name	Description	
TJA1022T	SO14	plastic small outline package; 14 leads; body width 3.9 mm	SOT108-1
TJA1022TK	HVSON14	plastic, thermal enhanced very thin small outline package; no leads; 14 terminals; body 3 × 4.5 × 0.85 mm	SOT1086-2

5. Block diagram

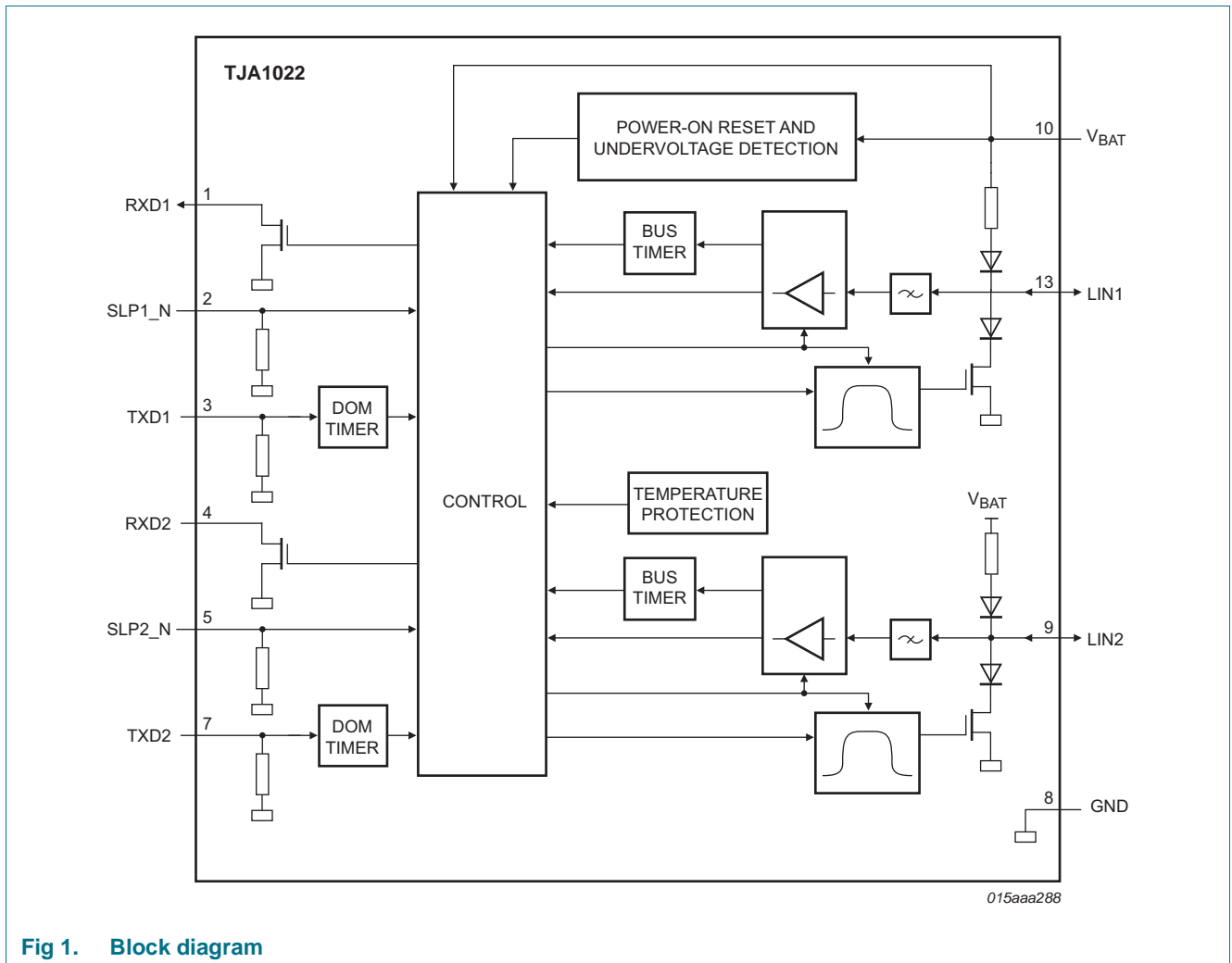

Fig 1. Block diagram

6. Pinning information

6.1 Pinning

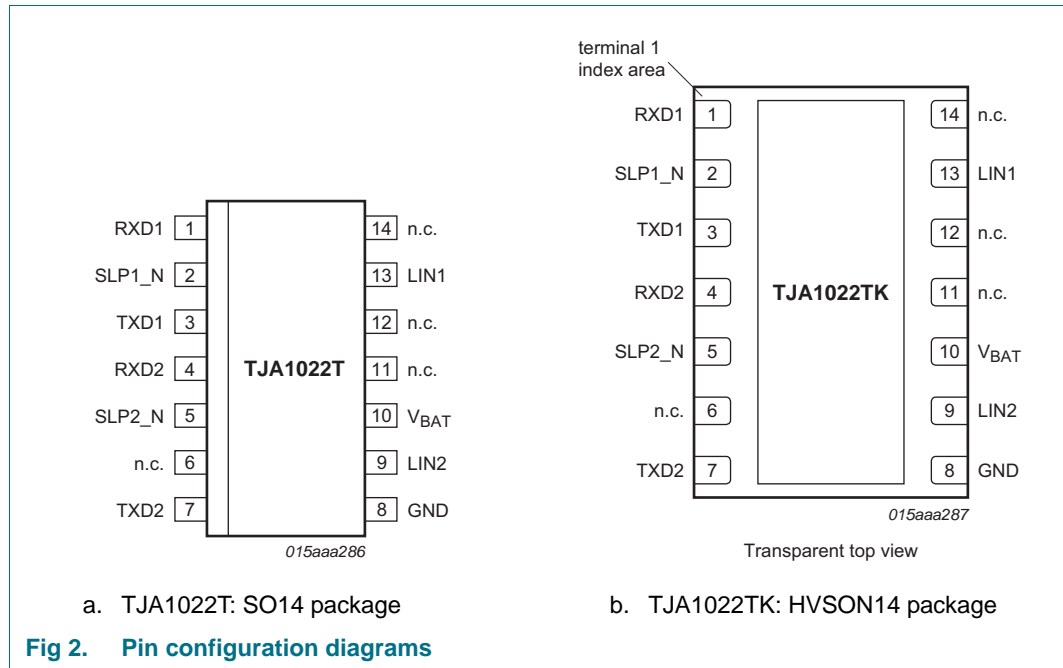

Fig 2. Pin configuration diagrams

6.2 Pin description

Table 3. Pin description

Symbol	Pin	Description
RXD1	1	receive data output 1 (open-drain); active LOW after a wake-up event
SLP1_N	2	sleep control input 1 (active LOW); resets wake-up request on RXD1
TXD1	3	transmit data input 1
RXD2	4	receive data output 2 (open-drain); active LOW after a wake-up event
SLP2_N	5	sleep control input 2 (active LOW); resets wake-up request on RXD2
n.c.	6	not connected
TXD2	7	transmit data input 2
GND	8 ^[1]	ground
LIN2	9	LIN bus line 2 input/output
V _{BAT}	10	battery supply
n.c.	11	not connected
n.c.	12	not connected
LIN1	13	LIN bus line 1 input/output
n.c.	14	not connected

[1] For enhanced thermal and electrical performance, the exposed center pad of the HVSON14 package should be soldered to board ground (and not to any other voltage level).

7. Functional description

The TJA1022 is the interface between the LIN master/slave protocol controller and the physical bus in a LIN network. According to the Open System Interconnect (OSI) model, this is the LIN physical layer.

The LIN transceivers are optimized for, but not limited to, automotive applications with excellent ElectroMagnetic Compatibility (EMC) performance.

7.1 LIN 2.x/SAE J2602 compliant

The TJA1022 is fully LIN 2.0, LIN 2.1, LIN 2.2 and SAE J2602 compliant. Since the LIN physical layer is independent of higher OSI model layers (e.g. the LIN protocol), nodes containing a LIN 2.2-compliant physical layer can be combined, without restriction, with LIN physical layer nodes that comply with earlier revisions (i.e. LIN 1.0, LIN 1.1, LIN 1.2, LIN 1.3, LIN 2.0 and LIN 2.1).

7.2 Operating modes

The transceivers are fully operational in Normal mode. A low-power Sleep mode is also supported, as well as a Reset mode. Standby mode facilitates the transition between Sleep and Normal modes.

The transceivers operate independently (except in Reset mode), so one transceiver can be in Normal mode while the other is Sleep or Standby etc. Power consumption is at a minimum when both transceivers are in Sleep mode.

7.2.1 Normal mode

In Normal mode, the TJA1022 can transmit and receive data via the LIN bus lines. The transceivers operate independently, so one can be active while the other is off.

A transceiver will switch from Sleep or Standby mode to Normal mode if SLPx_N is held HIGH for t_{gotonorm} . If SLPx_N is held LOW for $t_{\text{gotosleep}}$, the transceiver will switch from Normal to Sleep mode.

The receivers detect data streams on the LIN bus lines (via pins LIN1 and LIN2) and transfer the input via pins RXD1 and RXD2 to the microcontroller (see [Figure 6](#)): HIGH for a recessive level and LOW for a dominant level on the bus. The receivers have supply-voltage related thresholds with hysteresis and integrated filters to suppress bus line noise.

Transmit data streams from the protocol controller are detected on the TXDx pins and are converted by the transmitters into optimized bus signals shaped to minimize EME. The LIN bus output pins are pulled HIGH via internal slave termination resistors. For a master application, an external resistor in series with a diode should be connected between pin V_{BAT} and the appropriate LINx pin (see [Figure 6](#)).

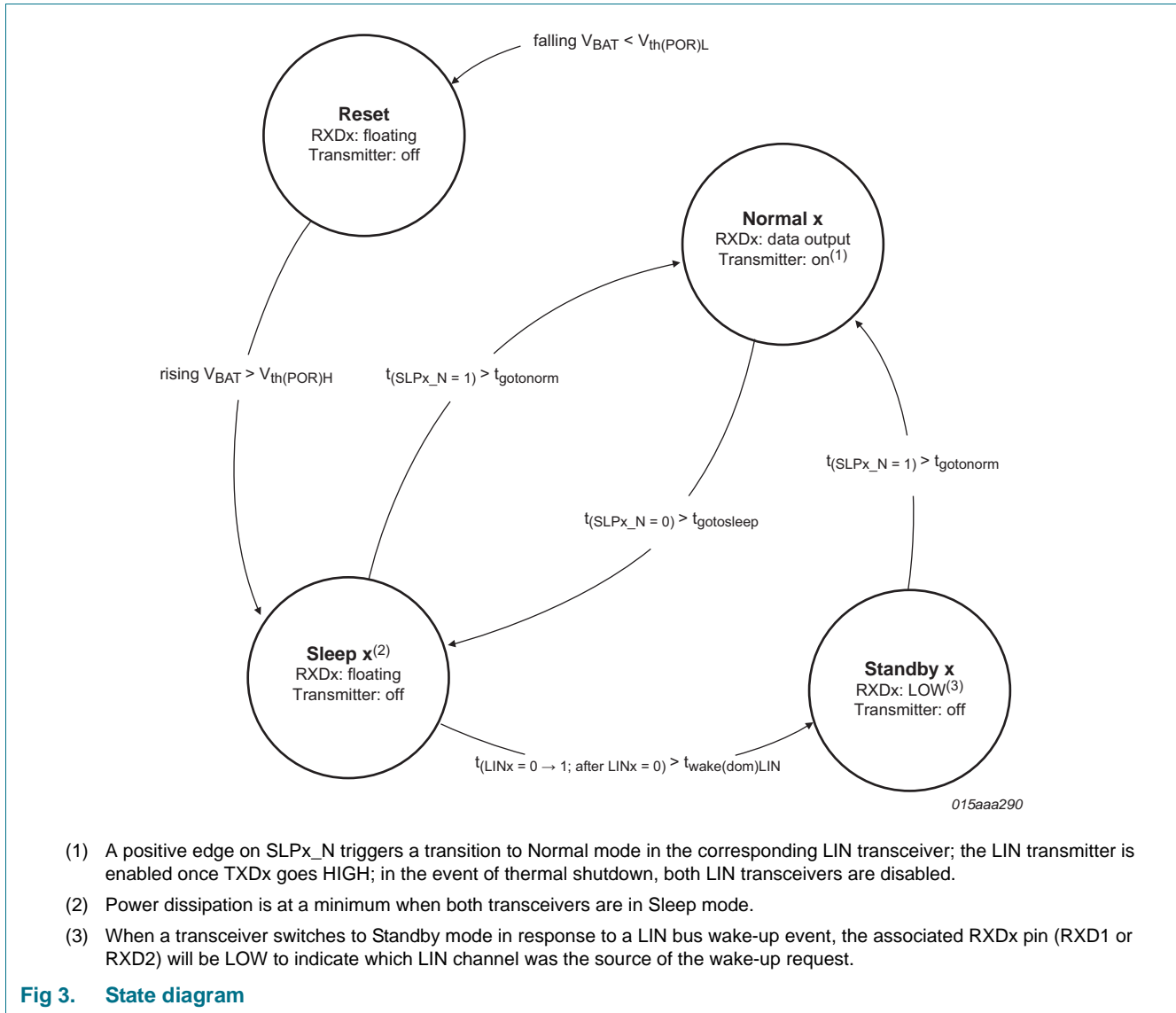

- (1) A positive edge on SLPx_N triggers a transition to Normal mode in the corresponding LIN transceiver; the LIN transmitter is enabled once TXDx goes HIGH; in the event of thermal shutdown, both LIN transceivers are disabled.
- (2) Power dissipation is at a minimum when both transceivers are in Sleep mode.
- (3) When a transceiver switches to Standby mode in response to a LIN bus wake-up event, the associated RXDx pin (RXD1 or RXD2) will be LOW to indicate which LIN channel was the source of the wake-up request.

7.2.2 Sleep mode

A transceiver will switch to Sleep mode from Normal mode if SLPx_N is held LOW for $t_{\text{gotosleep}}$. The relevant LIN transmit path is disabled as soon as SLPx_N goes LOW. Power consumption is very low when both transceivers are in Sleep mode.

The voltage levels on LINx and TXDx have no effect on a transition to Sleep mode. So the transceiver will still switch to Sleep mode even if TXDx is held LOW or there is a continuous dominant level on LINx (e.g. due to a short circuit to ground).

Although current consumption is extremely low when both transceivers are in Sleep mode, the TJA1022 can still be woken up remotely via the LIN bus pins or by the microcontroller via pins SLPx_N. Filters on the receiver inputs (LIN1 and LIN 2) and on pins SLPx_N prevent unwanted wake-up events occurring due to automotive transients or radio frequency interference. To be valid, all wake-up events must be maintained for a specific length of time ($t_{\text{wake(dom)LIN}}$ for a remote wake-up and t_{gotonorm} for a wake-up via SLPx_N). Pin RXDx is floating when a transceiver is in Sleep mode.

If a remote wake-up event (see [Figure 4](#)) is detected on either of the LIN bus lines, the associated transceiver will switch to Standby mode. A wake-up initiated by the microcontroller (SLPx_N HIGH for $t_{gotonorm}$) will cause the relevant transceiver to switch to Normal mode while the other transceiver remains in its current state.

7.2.3 Standby mode

Standby mode is an intermediate mode between Sleep and Normal modes. A transceiver will switch from Sleep mode to Standby mode in response to a LIN bus wake-up event. Pin RXDx will go low to indicate to the microcontroller the source of the remote wake-up (LIN1 or LIN2). A transceiver will switch from Standby to Normal mode if the microcontroller holds SLPx_N HIGH for $t_{gotonorm}$.

7.2.4 Reset mode

When the TJA1022 is in Reset mode, all input signals are ignored and all output drivers are off. The TJA1022 switches to Reset mode when the voltage on V_{BAT} drops below the LOW-level power-on reset threshold, $V_{th(POR)L}$. When the voltage on V_{BAT} rises above the HIGH-level power-on reset threshold, $V_{th(POR)H}$, the transceivers switch to Sleep mode.

Table 4. Operating modes

Mode	SLPx_N	RXDx	Transmitter x	Description
Reset	x	floating	off	all inputs ignored; all output drivers off
Sleep x ^[1]	0	floating	off	no wake-up request detected
Standby x ^[2]	0	LOW ^[3]	off	remote wake-up request detected
Normal x	1	HIGH: recessive LOW: dominant	on/off ^[4]	bus signal shaping enabled

[1] Both transceivers enter Sleep mode after a power-on reset (e.g. after switching on V_{BAT}).

[2] The appropriate transceiver will switch automatically to Standby x mode if a remote LINx wake-up event is detected in Sleep x mode.

[3] RXDx will be LOW to indicate the source of the remote wake-up request; RXDx will go HIGH in response to a positive edge on pin SLPx_N.

[4] A positive edge on SLPx_N will trigger a transition to Normal mode; the transmitter will be off if TXDx is LOW and will be enabled as soon as TXDx goes HIGH.

7.3 Transceiver wake-up

7.3.1 Remote wake-up via the LIN bus

A falling edge on pin LINx followed by a LOW level maintained for $t_{wake(dom)LIN}$ followed by a rising edge on pin LINx triggers a remote wake-up (see [Figure 4](#)). It should be noted that the time period $t_{wake(dom)LIN}$ is measured either in Normal mode while TXDx is HIGH, or in Sleep mode irrespective of the status of pin TXDx.

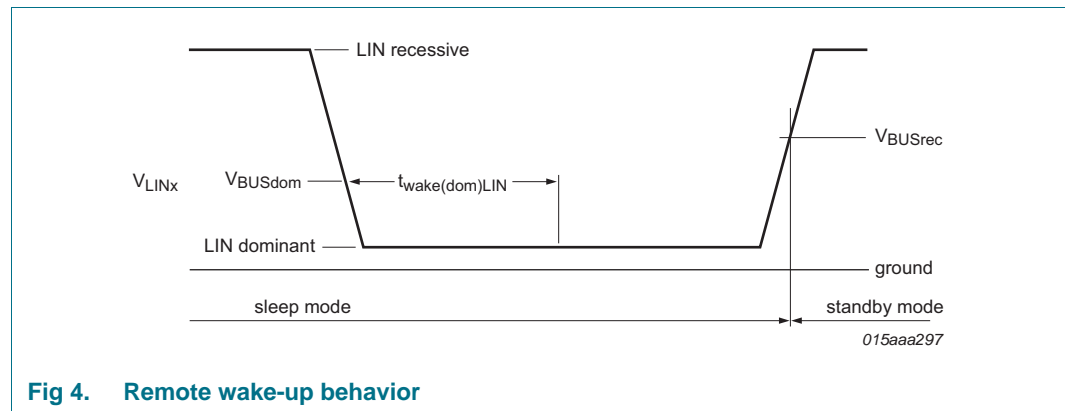

Fig 4. Remote wake-up behavior

7.3.2 Wake-up via SLPx_N

If SLPx_N is held HIGH for $t_{gotonorm}$, the transceiver will switch from Sleep mode to Normal mode.

7.4 Operation during automotive cranking pulses

TJA1022 remains fully operational during automotive cranking pulses because the LIN transceivers are fully specified down to $V_{BAT} = 5\text{ V}$.

7.5 Operation when supply voltage is outside specified operating range

If $V_{BAT} > 18\text{ V}$ or $V_{BAT} < 5\text{ V}$, the TJA1022 may remain operational, but parameter values cannot be guaranteed to remain within the operating ranges specified in [Table 7](#) and [Table 8](#).

In Normal mode:

- If the input level on pin TXDx is HIGH, the LIN transmitter output on pin LINx will be recessive.
- If the input level on pin LINx is recessive, the receiver output on pin RXDx will be HIGH.
- If the voltage on pin V_{BAT} rises to 27 V (e.g. during an automotive jump-start), the total LIN network pull-up resistance should be greater than 680 Ω and the total LIN network capacitance should be less than 6.8 nF to ensure reliable LIN data transfer.
- If the voltage on pin V_{BAT} drops below the LOW-level $V_{BAT\text{ LOW}}$ threshold, $V_{th(VBAT)L}$, the active LIN transmit path(s) is interrupted and both LIN outputs will be recessive. The previously active LIN transmit path(s) is switched on again when V_{BAT} rises above $V_{th(VBAT)H}$ and the associated TXDx pin is HIGH.

If the voltage on pin V_{BAT} drops below the LOW-level power-on reset threshold, $V_{th(POR)L}$, the TJA1022 switches to Reset mode (i.e. all output drivers are disabled and all inputs are ignored). The TJA1022 switches to Sleep mode if $V_{BAT} > V_{th(POR)H}$.

7.6 Fail-safe features

Pin TXD_x is pulled down to ground in order to force a predefined level on the transmit data input if the pin is disconnected.

Pin SLP_{x_N} is pulled down to ground to ensure the transceiver is forced to Sleep x mode if SLP_{x_N} is disconnected.

Pins RXD1 and RXD2 are set floating if V_{BAT} is disconnected.

The current in the transmitter output stage is limited in order to protect the transmitter against short circuits to pins V_{BAT} or GND.

A loss of power (pins V_{BAT} and GND) has no impact on the bus lines or on the microcontroller. No reverse current will flow from the bus lines into the LIN_x pins. The current path from V_{BAT} to LIN_x via the integrated LIN slave termination resistors remains. The TJA1022 can be disconnected from the power supply without influencing the LIN busses.

The output drivers on pins LIN1 and LIN2 are protected against overtemperature conditions. If the junction temperature exceeds the shutdown junction temperature, $T_{j(sd)}$, the thermal protection circuit disables the output drivers. The drivers are enabled again when the junction temperature falls below $T_{j(sd)}$ and pin TXD_x is HIGH.

The initial TXD dominant check prevents the bus being driven to a permanent dominant state (blocking all network communications) if pin TXD_x is forced permanently LOW by a hardware and/or software application failure. The input level on TXD_x is checked after a transition to Normal mode. If TXD_x is LOW, the transmit path will remain disabled and will only be enabled when TXD_x goes HIGH.

Once the transmitter has been enabled, a TXD dominant time-out timer is started every time pin TXD_x goes LOW. If the LOW state on pin TXD_x persists for longer than the TXD dominant time-out time ($t_{to(dom)TXD}$), the transmitter is disabled, releasing the bus line to recessive state. The TXD dominant time-out timer is reset when pin TXD_x goes HIGH.

8. Limiting values

Table 5. Limiting values

In accordance with the Absolute Maximum Rating System (IEC 60134). All voltages are referenced to pin GND, unless otherwise specified. Positive currents flow into the IC.

Symbol	Parameter	Conditions	Min	Max	Unit
V_{BAT}	battery supply voltage		-0.3	+42	V
V_{TXD}	voltage on pin TXD	pins TXD1 and TXD2	-0.3	+7	V
V_{RXD}	voltage on pin RXD	pins RXD1 and RXD2	-0.3	+7	V
V_{SLP_N}	voltage on pin SLP_N	pins SLP1_N and SLP2_N	-0.3	+7	V
V_{LIN}	voltage on pin LIN	pins LIN1 and LIN2; with respect to GND and V_{BAT}	-42	+42	V
$ \Delta V_{(LIN1-LIN2)} $	voltage difference between pin LIN1 and pin LIN2 (absolute value)		-	42	V
V_{ESD}	electrostatic discharge voltage				
	according to IEC 61000-4-2	on pins LIN1, LIN2 and V_{BAT}	[1] -8	+8	kV
	human body model	on pins LIN1, LIN2 and V_{BAT}	[2] -8	+8	kV
		on pins TXD1, TXD2, RXD1, RXD2, SLP1_N and SLP2_N	[2] -2	+2	kV
	charge device model	all pins	-750	+750	V
	machine model	all pins	[3] -200	+200	V
T_{vj}	virtual junction temperature		[4] -40	+150	°C
T_{stg}	storage temperature		-55	+150	°C

[1] Equivalent to discharging a 150 pF capacitor through a 330 Ω resistor.

[2] Equivalent to discharging a 100 pF capacitor through a 1.5 k Ω resistor.

[3] Equivalent to discharging a 200 pF capacitor through a 10 Ω resistor and a 0.75 μ H coil.

[4] Junction temperature in accordance with IEC 60747-1. An alternative definition is: $T_j = T_{amb} + P \times R_{th(j-a)}$, where $R_{th(j-a)}$ is a fixed value. The rating for T_{vj} limits the allowable combinations of power dissipation (P) and ambient temperature (T_{amb}).

9. Thermal characteristics

Table 6. Thermal characteristics

According to IEC 60747-1.

Symbol	Parameter	Conditions	Typ	Unit
$R_{th(j-a)}$	thermal resistance from junction to ambient	SO14 package; in free air	145	K/W
		HVSON14 package; in free air	50	K/W

10. Static characteristics

Table 7. Static characteristics

$V_{BAT} = 5\text{ V to }18\text{ V}$; $T_{vj} = -40\text{ °C to }+150\text{ °C}$; $R_{L(LIN-VBAT)} = 500\ \Omega$; all voltages are referenced to pin GND; positive currents flow into the IC; typical values are given at $V_{BAT} = 12\text{ V}$; unless otherwise specified.^[1]

Symbol	Parameter	Conditions	Min	Typ	Max	Unit
Supply						
V_{BAT}	battery supply voltage		5	-	18	V
I_{BAT}	battery supply current	Sleep mode (both channels); bus recessive (both channels); $V_{LINx} = V_{BAT}$; $V_{SLPx_N} = 0\text{ V}$	2.5	7	10	μA
		Sleep mode (both channels); bus dominant (both channels); $V_{LINx} = 0\text{ V}$; $V_{SLPx_N} = 0\text{ V}$; $V_{BAT} = 12\text{ V}$	300	800	3200	μA
		Standby mode (both channels); bus recessive (both channels); $V_{LINx} = V_{BAT}$; $V_{SLPx_N} = 0\text{ V}$	2.5	7	10	μA
		Standby mode (both channels); bus dominant (both channels); $V_{LINx} = 0\text{ V}$; $V_{SLPx_N} = 0\text{ V}$; $V_{BAT} = 12\text{ V}$	200	600	2000	μA
		Normal mode (both channels); bus recessive (both channels); $V_{TXDx} = 5\text{ V}$; $V_{LINx} = V_{BAT}$; $V_{SLPx_N} = 5\text{ V}$	300	1600	3200	μA
		Normal mode (both channels); bus dominant (both channels); $V_{TXDx} = 0\text{ V}$; $V_{SLPx_N} = 5\text{ V}$; $V_{BAT} = 12\text{ V}$	1	4	10	mA
Undervoltage reset						
$V_{th(POR)L}$	LOW-level power-on reset threshold voltage	power-on reset	1.6	3.1	3.9	V
$V_{th(POR)H}$	HIGH-level power-on reset threshold voltage		2.3	3.4	4.3	V
$V_{hys(POR)}$	power-on reset hysteresis voltage		[2] 0.05	0.3	1	V
$V_{th(VBATL)L}$	LOW-level V_{BAT} LOW threshold voltage		3.9	4.4	4.7	V
$V_{th(VBATL)H}$	HIGH-level V_{BAT} LOW threshold voltage		4.2	4.7	4.9	V
$V_{hys(VBATL)}$	V_{BAT} LOW hysteresis voltage		[2] 0.15	0.3	0.6	V
Pins TXDx and SLPx_N						
V_{IH}	HIGH-level input voltage		2	-	7	V
V_{IL}	LOW-level input voltage		-0.3	-	+0.8	V
V_{hys}	hysteresis voltage		[2] 50	200	400	mV
R_{pd}	pull-down resistance	on TXDx	50	125	325	k Ω
		on SLPx_N	100	250	650	k Ω

Table 7. Static characteristics ...continued

$V_{BAT} = 5\text{ V to }18\text{ V}$; $T_{vj} = -40\text{ }^{\circ}\text{C to }+150\text{ }^{\circ}\text{C}$; $R_{L(LIN-VBAT)} = 500\ \Omega$; all voltages are referenced to pin GND; positive currents flow into the IC; typical values are given at $V_{BAT} = 12\text{ V}$; unless otherwise specified.^[1]

Symbol	Parameter	Conditions	Min	Typ	Max	Unit
I_{IL}	LOW-level input current	$V_{TXDx} = 0\text{ V}$ or $V_{SLPx_N} = 0\text{ V}$	-5	-	+5	μA
Pin RXDx (open-drain)						
I_{OL}	LOW-level output current	$V_{RXDx} = 0.4\text{ V}$	2	-	-	mA
I_{LH}	HIGH-level leakage current		[2] -5	-	+5	μA
Pin LINx						
I_{BUS_LIM}	current limitation for driver dominant state	$V_{BAT} = 18\text{ V}$; $V_{LINx} = 18\text{ V}$; $V_{TXDx} = 0\text{ V}$	40	-	100	mA
$I_{BUS_PAS_dom}$	receiver dominant input leakage current including pull-up resistor	$V_{BAT} = 12\text{ V}$; $V_{LINx} = 0\text{ V}$; $V_{TXDx} = 5\text{ V}$	[2] -600	-	-	μA
$I_{BUS_PAS_rec}$	receiver recessive input leakage current	$V_{BAT} = 5\text{ V}$; $V_{LINx} = 18\text{ V}$; $V_{TXDx} = 5\text{ V}$	[2] -	0	1	μA
$I_{BUS_NO_GND}$	loss-of-ground bus current	$V_{BAT} = 18\text{ V}$; $V_{LINx} = 0\text{ V}$	[2] -750	-	+10	μA
$I_{BUS_NO_BAT}$	loss-of-battery bus current	$V_{BAT} = 0\text{ V}$; $V_{LINx} = 18\text{ V}$	[2] -	-	1	μA
V_{BUSdom}	receiver dominant state		-	-	$0.4V_{BAT}$	V
V_{BUSrec}	receiver recessive state		$0.6V_{BAT}$	-	-	V
V_{BUS_CNT}	receiver center voltage	$V_{BUS_CNT} = (V_{BUSdom} + V_{BUSrec}) / 2$	$0.475V_{BAT}$	$0.5V_{BAT}$	$0.525V_{BAT}$	V
V_{HYS}	receiver hysteresis voltage	$V_{HYS} = V_{BUSrec} - V_{BUSdom}$	-	-	$0.175V_{BAT}$	V
$V_{SerDiode}$	voltage drop at the serial diode	in pull-up path with R_{slave} ; $I_{SerDiode} = 0.9\text{ mA}$	[2] 0.4	-	1.0	V
$V_{O(dom)}$	dominant output voltage	Normal mode; $V_{TXDx} = 0\text{ V}$; $V_{BAT} = 7.0\text{ V}$	[2] -	-	1.4	V
		Normal mode; $V_{TXDx} = 0\text{ V}$; $V_{BAT} = 18\text{ V}$	[2] -	-	2.0	V
R_{slave}	slave resistance		20	30	60	k Ω
C_{LIN}	capacitance on pin LIN	pins LIN1 and LIN2; with respect to GND	[2] -	-	20	pF
Thermal shutdown						
$T_{j(sd)}$	shutdown junction temperature		[2] 150	-	200	$^{\circ}\text{C}$

[1] All parameters are guaranteed over the virtual junction temperature range by design. Factory testing uses correlated test conditions to cover the specified temperature and power supply voltage range.

[2] Not tested in production; guaranteed by design.

11. Dynamic characteristics

Table 8. Dynamic characteristics

$V_{BAT} = 5\text{ V to }18\text{ V}$; $T_{vj} = -40\text{ }^{\circ}\text{C to }+150\text{ }^{\circ}\text{C}$; $R_{L(LIN-VBAT)} = 500\ \Omega$; all voltages are referenced to pin GND; positive currents flow into the IC; typical values are given at $V_{BAT} = 12\text{ V}$, unless otherwise specified.^[1]

Symbol	Parameter	Conditions	Min	Typ	Max	Unit	
Duty cycles							
$\delta 1$	duty cycle 1	$V_{th(rec)(max)} = 0.744 \times V_{BAT}$; $V_{th(dom)(max)} = 0.581 \times V_{BAT}$; $t_{bit} = 50\ \mu\text{s}$; $V_{BAT} = 7\text{ V to }18\text{ V}$	[2][4][5]	0.396	-	-	
		$V_{th(rec)(max)} = 0.768 \times V_{BAT}$; $V_{th(dom)(max)} = 0.6 \times V_{BAT}$; $t_{bit} = 50\ \mu\text{s}$; $V_{BAT} = 5\text{ V to }7\text{ V}$	[2][4][5]	0.396	-	-	
$\delta 2$	duty cycle 2	$V_{th(rec)(min)} = 0.422 \times V_{BAT}$; $V_{th(dom)(min)} = 0.284 \times V_{BAT}$; $t_{bit} = 50\ \mu\text{s}$; $V_{BAT} = 7.6\text{ V to }18\text{ V}$	[3][4][5]	-	-	0.581	
		$V_{th(rec)(min)} = 0.405 \times V_{BAT}$; $V_{th(dom)(min)} = 0.271 \times V_{BAT}$; $t_{bit} = 50\ \mu\text{s}$; $V_{BAT} = 5.6\text{ V to }7.6\text{ V}$	[3][4][5]	-	-	0.581	
$\delta 3$	duty cycle 3	$V_{th(rec)(max)} = 0.778 \times V_{BAT}$; $V_{th(dom)(max)} = 0.616 \times V_{BAT}$; $t_{bit} = 96\ \mu\text{s}$; $V_{BAT} = 7\text{ V to }18\text{ V}$	[2][4][5]	0.417	-	-	
		$V_{th(rec)(max)} = 0.805 \times V_{BAT}$; $V_{th(dom)(max)} = 0.637 \times V_{BAT}$; $t_{bit} = 96\ \mu\text{s}$; $V_{BAT} = 5\text{ V to }7\text{ V}$	[2][4][5]	0.417	-	-	
$\delta 4$	duty cycle 4	$V_{th(rec)(min)} = 0.389 \times V_{BAT}$; $V_{th(dom)(min)} = 0.251 \times V_{BAT}$; $t_{bit} = 96\ \mu\text{s}$; $V_{BAT} = 7.6\text{ V to }18\text{ V}$	[3][4][5]	-	-	0.590	
		$V_{th(rec)(min)} = 0.372 \times V_{BAT}$; $V_{th(dom)(min)} = 0.238 \times V_{BAT}$; $t_{bit} = 96\ \mu\text{s}$; $V_{BAT} = 5.6\text{ V to }7.6\text{ V}$	[3][4][5]	-	-	0.590	
Timing characteristics							
t_{rx_pd}	receiver propagation delay	rising and falling; $C_{RXDX} = 20\text{ pF}$; $R_{RXDX} = 2.4\text{ k}\Omega$	[5]	-	-	6	μs
t_{rx_sym}	receiver propagation delay symmetry	$C_{RXDX} = 20\text{ pF}$; $R_{RXDX} = 2.4\text{ k}\Omega$; rising edge with respect to falling edge	[5]	-2	-	+2	μs
$t_{wake(dom)LIN}$	LIN dominant wake-up time	Sleep mode		30	80	150	μs
$t_{gotonorm}$	go to normal time	time period for mode change from Sleep or Standby mode to Normal mode		2	6	10	μs
$t_{init(norm)}$	normal mode initialization time			7	-	20	μs
$t_{gotosleep}$	go to sleep time	time period for mode change from Normal to Sleep mode		2	6	10	μs
$t_{to(dom)TXD}$	TXD dominant time-out time	timer started at falling edge on TXDx		6	12	50	ms

[1] All parameters are guaranteed over the virtual junction temperature range by design. Factory testing uses correlated test conditions to cover the specified temperature and power supply voltage ranges.

- [2] $\delta I, \delta 3 = \frac{t_{bus(rec)(min)}}{2 \times t_{bit}}$. Variable $t_{bus(rec)(min)}$ is illustrated in the LIN timing diagram in [Figure 5](#).
- [3] $\delta 2, \delta 4 = \frac{t_{bus(rec)(max)}}{2 \times t_{bit}}$. Variable $t_{bus(rec)(max)}$ is illustrated in the LIN timing diagram in [Figure 5](#).
- [4] Bus load conditions: $C_{BUS} = 1 \text{ nF}$ and $R_{BUS} = 1 \text{ k}\Omega$; $C_{BUS} = 6.8 \text{ nF}$ and $R_{BUS} = 660 \text{ }\Omega$; $C_{BUS} = 10 \text{ nF}$ and $R_{BUS} = 500 \text{ }\Omega$.
- [5] See timing diagram in [Figure 5](#).

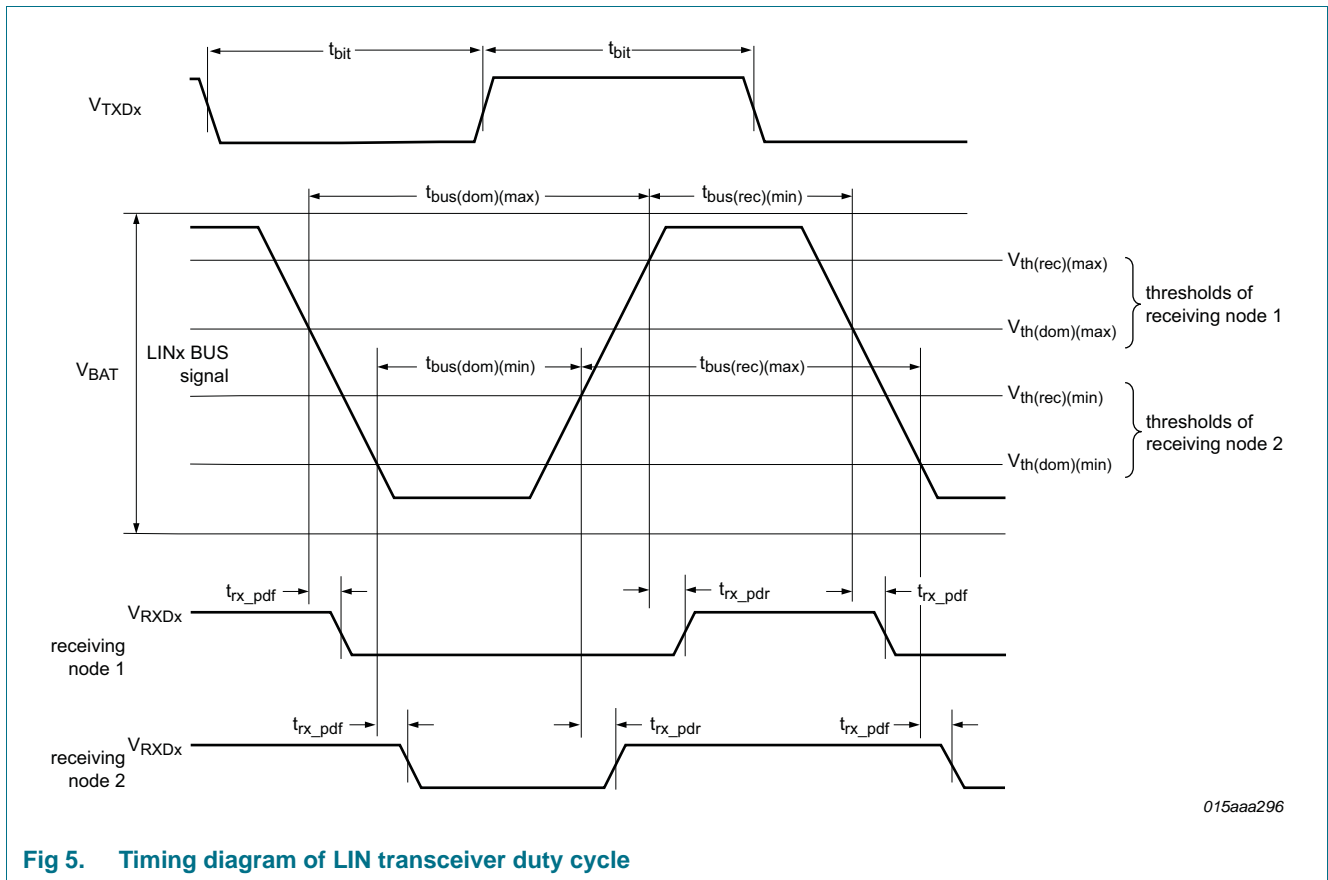

Fig 5. Timing diagram of LIN transceiver duty cycle

12. Application information

12.1 Application diagram

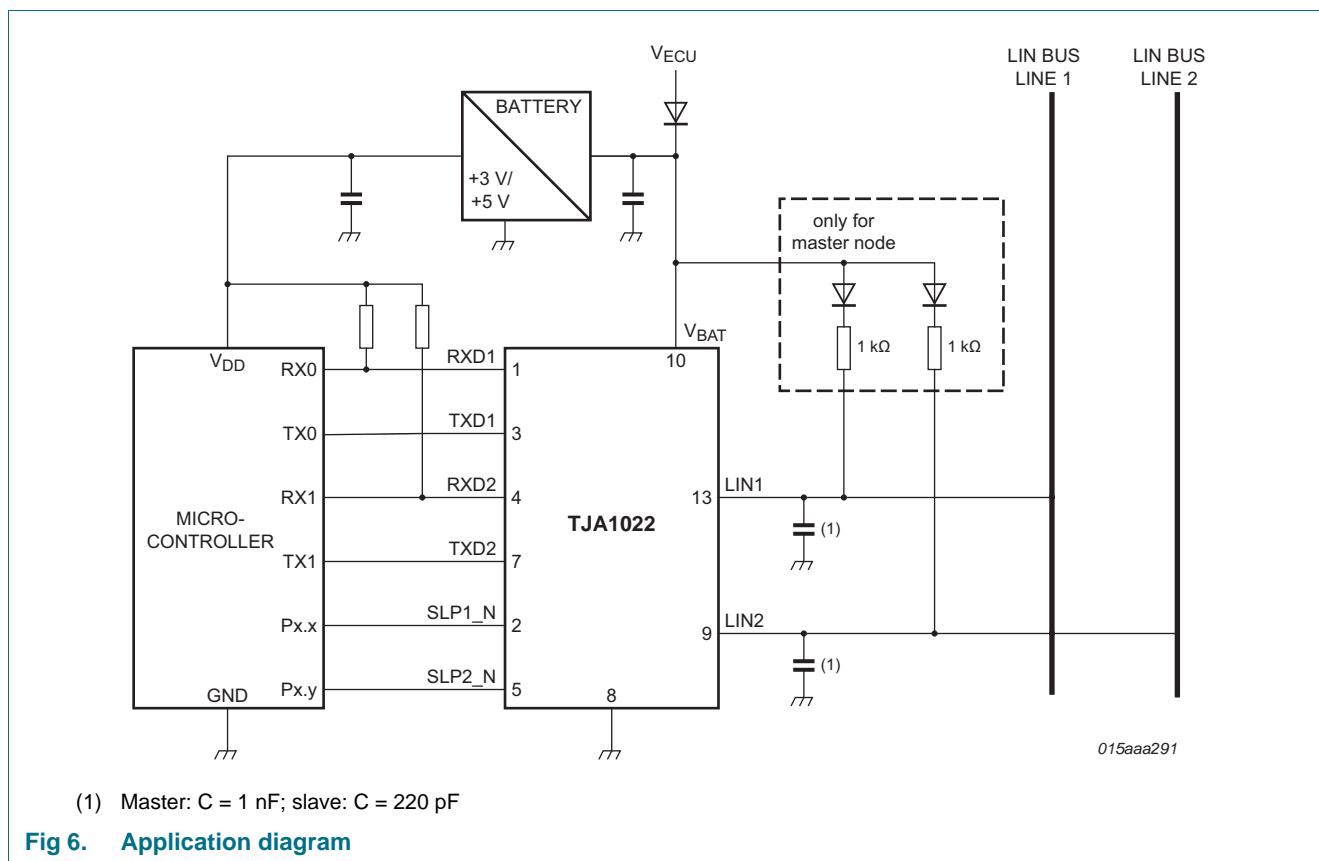

Fig 6. Application diagram

12.2 ESD robustness according to LIN EMC test specification

ESD robustness (IEC 61000-4-2) has been tested by an external test house according to the LIN EMC test specification (part of Conformance Test Specification Package for LIN 2.1, October 10th, 2008). The test report is available on request.

Table 9. ESD robustness (IEC 61000-4-2) according to LIN EMC test specification

Pin	Test configuration	Value	Unit
LIN	no capacitor connected to LIN pin	±12	kV
LIN	220 pF capacitor connected to LIN pin	±12	kV
V _{BAT}	100 nF capacitor connected to V _{BAT} pin	> 14	kV

12.3 Hardware requirements for LIN interfaces in automotive applications

The TJA1022 satisfies the "Hardware Requirements for LIN, CAN and FlexRay Interfaces in Automotive Applications", Version 1.2, March 2011.

13. Test information

13.1 Quality information

This product has been qualified to the appropriate Automotive Electronics Council (AEC) standard Q100 or Q101 and is suitable for use in automotive applications.

14. Package outline

SO14: plastic small outline package; 14 leads; body width 3.9 mm

SOT108-1

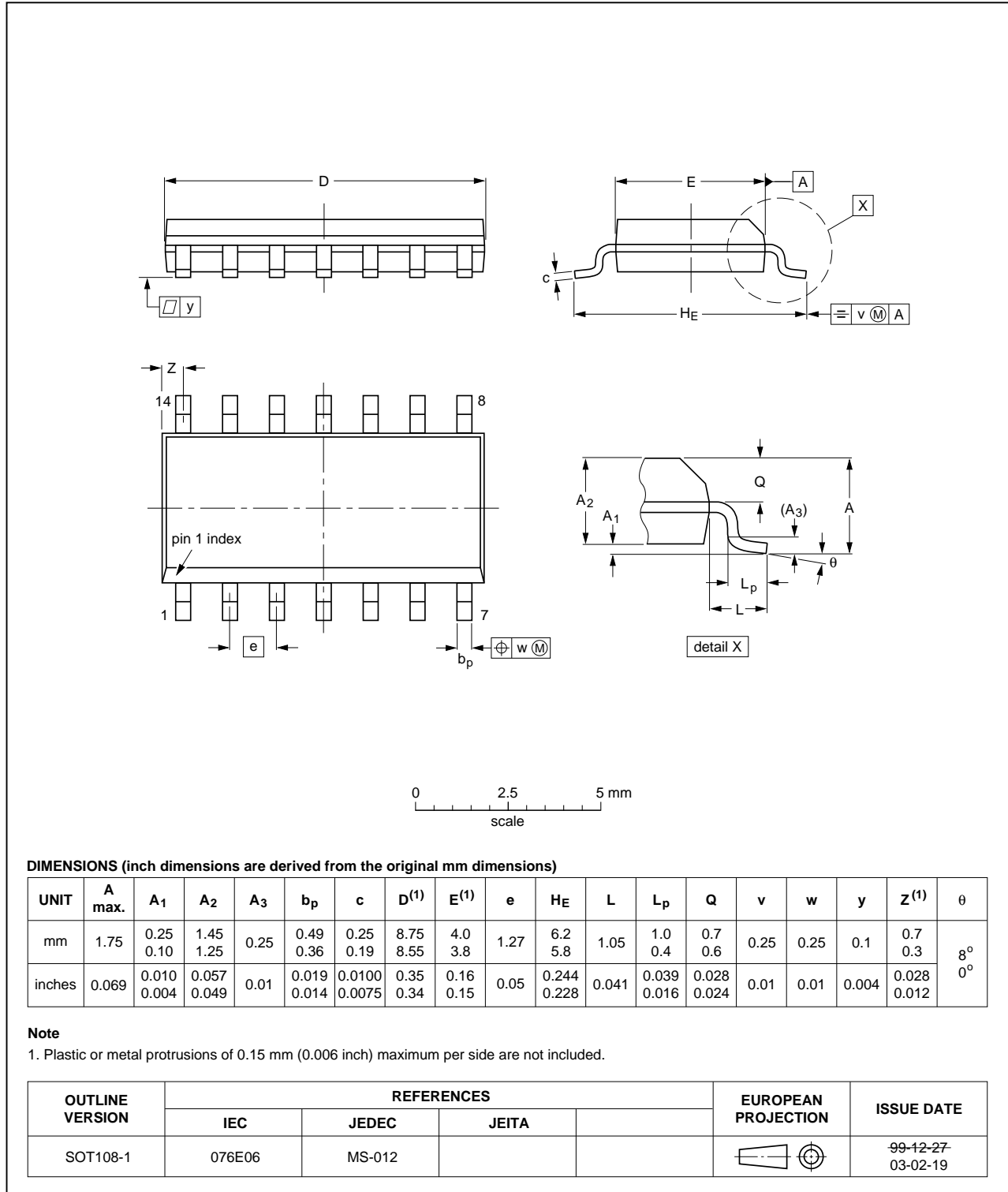

Fig 7. Package outline SOT108-1 (SO14)

HVSON14: plastic, thermal enhanced very thin small outline package; no leads; 14 terminals; body 3 x 4.5 x 0.85 mm

SOT1086-2

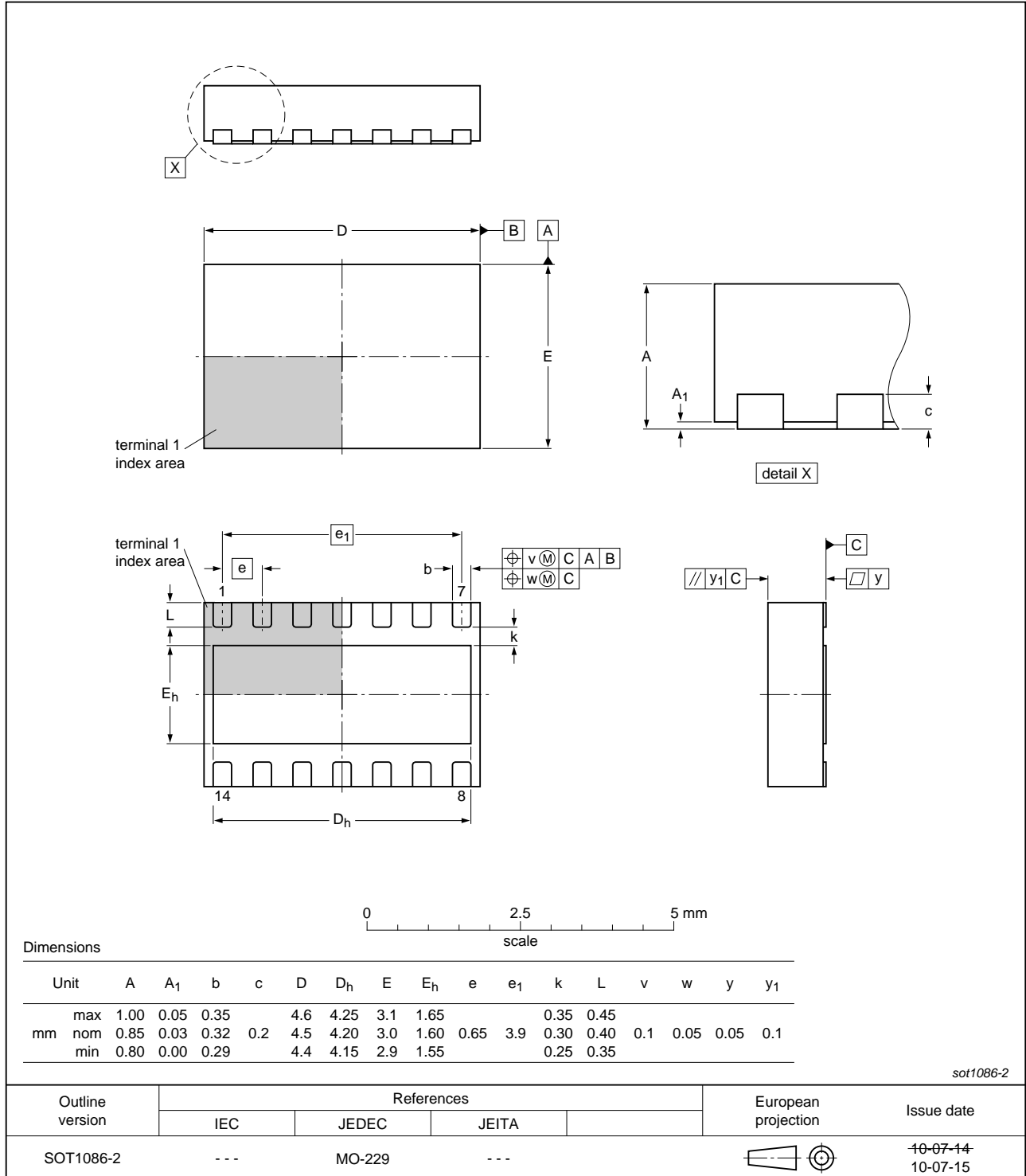

Fig 8. Package outline SOT1086-2 (HVSON14)

15. Handling information

All input and output pins are protected against ElectroStatic Discharge (ESD) under normal handling. When handling ensure that the appropriate precautions are taken as described in *JESD625-A* or equivalent standards.

16. Soldering of SMD packages

This text provides a very brief insight into a complex technology. A more in-depth account of soldering ICs can be found in Application Note *AN10365 "Surface mount reflow soldering description"*.

16.1 Introduction to soldering

Soldering is one of the most common methods through which packages are attached to Printed Circuit Boards (PCBs), to form electrical circuits. The soldered joint provides both the mechanical and the electrical connection. There is no single soldering method that is ideal for all IC packages. Wave soldering is often preferred when through-hole and Surface Mount Devices (SMDs) are mixed on one printed wiring board; however, it is not suitable for fine pitch SMDs. Reflow soldering is ideal for the small pitches and high densities that come with increased miniaturization.

16.2 Wave and reflow soldering

Wave soldering is a joining technology in which the joints are made by solder coming from a standing wave of liquid solder. The wave soldering process is suitable for the following:

- Through-hole components
- Leaded or leadless SMDs, which are glued to the surface of the printed circuit board

Not all SMDs can be wave soldered. Packages with solder balls, and some leadless packages which have solder lands underneath the body, cannot be wave soldered. Also, leaded SMDs with leads having a pitch smaller than ~0.6 mm cannot be wave soldered, due to an increased probability of bridging.

The reflow soldering process involves applying solder paste to a board, followed by component placement and exposure to a temperature profile. Leaded packages, packages with solder balls, and leadless packages are all reflow solderable.

Key characteristics in both wave and reflow soldering are:

- Board specifications, including the board finish, solder masks and vias
- Package footprints, including solder thieves and orientation
- The moisture sensitivity level of the packages
- Package placement
- Inspection and repair
- Lead-free soldering versus SnPb soldering

16.3 Wave soldering

Key characteristics in wave soldering are:

- Process issues, such as application of adhesive and flux, clinching of leads, board transport, the solder wave parameters, and the time during which components are exposed to the wave
- Solder bath specifications, including temperature and impurities

16.4 Reflow soldering

Key characteristics in reflow soldering are:

- Lead-free versus SnPb soldering; note that a lead-free reflow process usually leads to higher minimum peak temperatures (see [Figure 9](#)) than a SnPb process, thus reducing the process window
- Solder paste printing issues including smearing, release, and adjusting the process window for a mix of large and small components on one board
- Reflow temperature profile; this profile includes preheat, reflow (in which the board is heated to the peak temperature) and cooling down. It is imperative that the peak temperature is high enough for the solder to make reliable solder joints (a solder paste characteristic). In addition, the peak temperature must be low enough that the packages and/or boards are not damaged. The peak temperature of the package depends on package thickness and volume and is classified in accordance with [Table 10](#) and [11](#)

Table 10. SnPb eutectic process (from J-STD-020C)

Package thickness (mm)	Package reflow temperature (°C)	
	Volume (mm ³)	
	< 350	≥ 350
< 2.5	235	220
≥ 2.5	220	220

Table 11. Lead-free process (from J-STD-020C)

Package thickness (mm)	Package reflow temperature (°C)		
	Volume (mm ³)		
	< 350	350 to 2000	> 2000
< 1.6	260	260	260
1.6 to 2.5	260	250	245
> 2.5	250	245	245

Moisture sensitivity precautions, as indicated on the packing, must be respected at all times.

Studies have shown that small packages reach higher temperatures during reflow soldering, see [Figure 9](#).

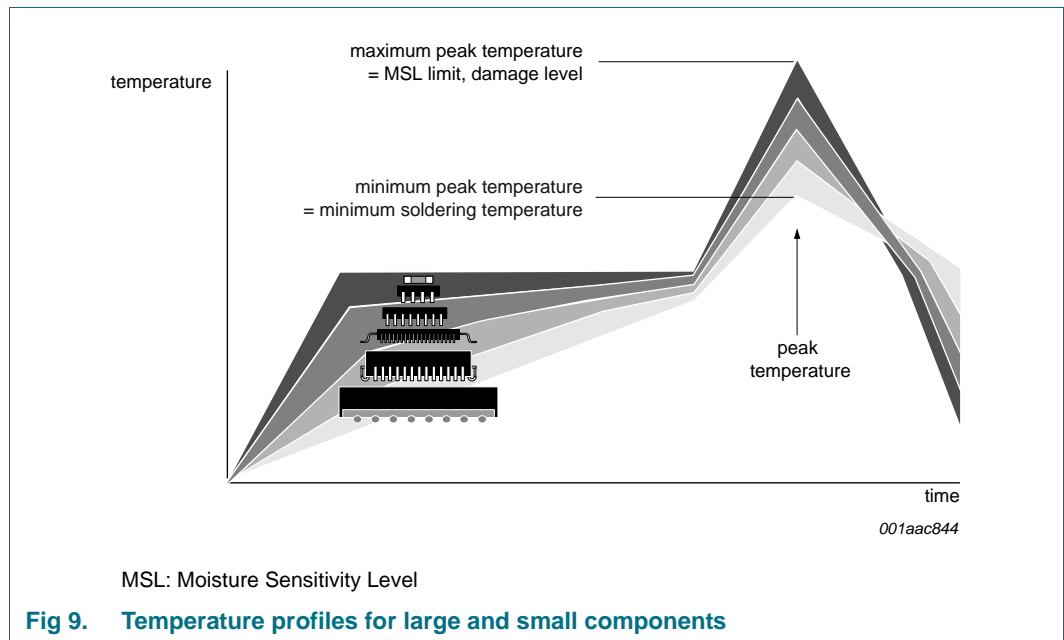

For further information on temperature profiles, refer to Application Note *AN10365* “*Surface mount reflow soldering description*”.

17. Soldering of HVSON packages

[Section 16](#) contains a brief introduction to the techniques most commonly used to solder Surface Mounted Devices (SMD). A more detailed discussion on soldering HVSON leadless package ICs can be found in the following application notes:

- *AN10365* “*Surface mount reflow soldering description*”
- *AN10366* “*HVQFN application information*”

18. Mounting

The TJA1022 pin layout has been designed to be compatible with the TJA1020, TJA1021 and TJA1027. This makes it possible to design a board with a single socket that can accommodate all four IC's. The appropriate device would be inserted into the socket, depending on the application, as illustrated in [Figure 10](#).

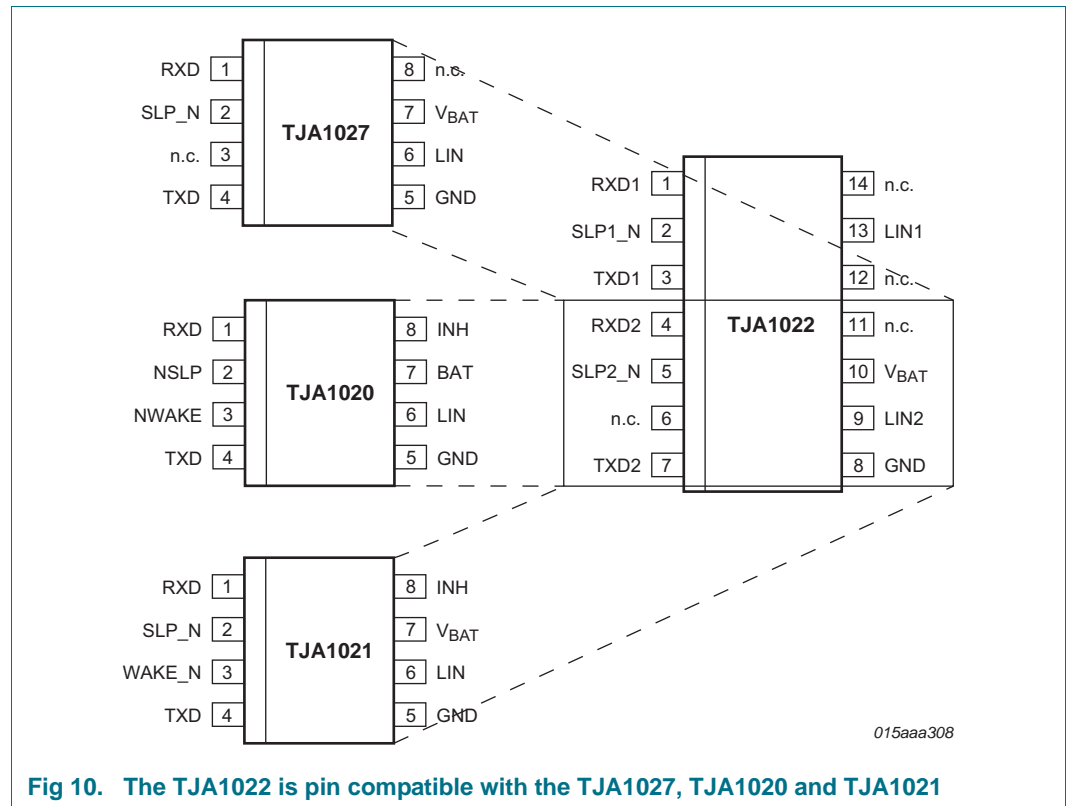

Fig 10. The TJA1022 is pin compatible with the TJA1027, TJA1020 and TJA1021

19. Revision history

Table 12. Revision history

Document ID	Release date	Data sheet status	Change notice	Supersedes
TJA1022 v.1	20120330	Product data sheet	-	-

20. Legal information

20.1 Data sheet status

Document status ^{[1][2]}	Product status ^[3]	Definition
Objective [short] data sheet	Development	This document contains data from the objective specification for product development.
Preliminary [short] data sheet	Qualification	This document contains data from the preliminary specification.
Product [short] data sheet	Production	This document contains the product specification.

[1] Please consult the most recently issued document before initiating or completing a design.

[2] The term 'short data sheet' is explained in section "Definitions".

[3] The product status of device(s) described in this document may have changed since this document was published and may differ in case of multiple devices. The latest product status information is available on the Internet at URL <http://www.nxp.com>.

20.2 Definitions

Draft — The document is a draft version only. The content is still under internal review and subject to formal approval, which may result in modifications or additions. NXP Semiconductors does not give any representations or warranties as to the accuracy or completeness of information included herein and shall have no liability for the consequences of use of such information.

Short data sheet — A short data sheet is an extract from a full data sheet with the same product type number(s) and title. A short data sheet is intended for quick reference only and should not be relied upon to contain detailed and full information. For detailed and full information see the relevant full data sheet, which is available on request via the local NXP Semiconductors sales office. In case of any inconsistency or conflict with the short data sheet, the full data sheet shall prevail.

Product specification — The information and data provided in a Product data sheet shall define the specification of the product as agreed between NXP Semiconductors and its customer, unless NXP Semiconductors and customer have explicitly agreed otherwise in writing. In no event however, shall an agreement be valid in which the NXP Semiconductors product is deemed to offer functions and qualities beyond those described in the Product data sheet.

20.3 Disclaimers

Limited warranty and liability — Information in this document is believed to be accurate and reliable. However, NXP Semiconductors does not give any representations or warranties, expressed or implied, as to the accuracy or completeness of such information and shall have no liability for the consequences of use of such information. NXP Semiconductors takes no responsibility for the content in this document if provided by an information source outside of NXP Semiconductors.

In no event shall NXP Semiconductors be liable for any indirect, incidental, punitive, special or consequential damages (including - without limitation - lost profits, lost savings, business interruption, costs related to the removal or replacement of any products or rework charges) whether or not such damages are based on tort (including negligence), warranty, breach of contract or any other legal theory.

Notwithstanding any damages that customer might incur for any reason whatsoever, NXP Semiconductors' aggregate and cumulative liability towards customer for the products described herein shall be limited in accordance with the *Terms and conditions of commercial sale* of NXP Semiconductors.

Right to make changes — NXP Semiconductors reserves the right to make changes to information published in this document, including without limitation specifications and product descriptions, at any time and without notice. This document supersedes and replaces all information supplied prior to the publication hereof.

Suitability for use in automotive applications — This NXP Semiconductors product has been qualified for use in automotive applications. Unless otherwise agreed in writing, the product is not designed, authorized or warranted to be suitable for use in life support, life-critical or safety-critical systems or equipment, nor in applications where failure or malfunction of an NXP Semiconductors product can reasonably be expected to result in personal injury, death or severe property or environmental damage. NXP Semiconductors and its suppliers accept no liability for inclusion and/or use of NXP Semiconductors products in such equipment or applications and therefore such inclusion and/or use is at the customer's own risk.

Applications — Applications that are described herein for any of these products are for illustrative purposes only. NXP Semiconductors makes no representation or warranty that such applications will be suitable for the specified use without further testing or modification.

Customers are responsible for the design and operation of their applications and products using NXP Semiconductors products, and NXP Semiconductors accepts no liability for any assistance with applications or customer product design. It is customer's sole responsibility to determine whether the NXP Semiconductors product is suitable and fit for the customer's applications and products planned, as well as for the planned application and use of customer's third party customer(s). Customers should provide appropriate design and operating safeguards to minimize the risks associated with their applications and products.

NXP Semiconductors does not accept any liability related to any default, damage, costs or problem which is based on any weakness or default in the customer's applications or products, or the application or use by customer's third party customer(s). Customer is responsible for doing all necessary testing for the customer's applications and products using NXP Semiconductors products in order to avoid a default of the applications and the products or of the application or use by customer's third party customer(s). NXP does not accept any liability in this respect.

Limiting values — Stress above one or more limiting values (as defined in the Absolute Maximum Ratings System of IEC 60134) will cause permanent damage to the device. Limiting values are stress ratings only and (proper) operation of the device at these or any other conditions above those given in the Recommended operating conditions section (if present) or the Characteristics sections of this document is not warranted. Constant or repeated exposure to limiting values will permanently and irreversibly affect the quality and reliability of the device.

Terms and conditions of commercial sale — NXP Semiconductors products are sold subject to the general terms and conditions of commercial sale, as published at <http://www.nxp.com/profile/terms>, unless otherwise agreed in a valid written individual agreement. In case an individual agreement is concluded only the terms and conditions of the respective agreement shall apply. NXP Semiconductors hereby expressly objects to applying the customer's general terms and conditions with regard to the purchase of NXP Semiconductors products by customer.

No offer to sell or license — Nothing in this document may be interpreted or construed as an offer to sell products that is open for acceptance or the grant, conveyance or implication of any license under any copyrights, patents or other industrial or intellectual property rights.

Export control — This document as well as the item(s) described herein may be subject to export control regulations. Export might require a prior authorization from competent authorities.

Quick reference data — The Quick reference data is an extract of the product data given in the Limiting values and Characteristics sections of this document, and as such is not complete, exhaustive or legally binding.

Translations — A non-English (translated) version of a document is for reference only. The English version shall prevail in case of any discrepancy between the translated and English versions.

20.4 Trademarks

Notice: All referenced brands, product names, service names and trademarks are the property of their respective owners.

21. Contact information

For more information, please visit: <http://www.nxp.com>

For sales office addresses, please send an email to: salesaddresses@nxp.com

22. Contents

1	General description	1	18	Mounting	22
2	Features and benefits	1	19	Revision history	23
2.1	General	1	20	Legal information	24
2.2	Protection	2	20.1	Data sheet status	24
3	Quick reference data	2	20.2	Definitions	24
4	Ordering information	2	20.3	Disclaimers	24
5	Block diagram	3	20.4	Trademarks	25
6	Pinning information	4	21	Contact information	25
6.1	Pinning	4	22	Contents	26
6.2	Pin description	4			
7	Functional description	5			
7.1	LIN 2.x/SAE J2602 compliant	5			
7.2	Operating modes	5			
7.2.1	Normal mode	5			
7.2.2	Sleep mode	6			
7.2.3	Standby mode	7			
7.2.4	Reset mode	7			
7.3	Transceiver wake-up	8			
7.3.1	Remote wake-up via the LIN bus	8			
7.3.2	Wake-up via SLPx_N	8			
7.4	Operation during automotive cranking pulses	8			
7.5	Operation when supply voltage is outside specified operating range	8			
7.6	Fail-safe features	9			
8	Limiting values	10			
9	Thermal characteristics	10			
10	Static characteristics	11			
11	Dynamic characteristics	13			
12	Application information	15			
12.1	Application diagram	15			
12.2	ESD robustness according to LIN EMC test specification	15			
12.3	Hardware requirements for LIN interfaces in automotive applications	15			
13	Test information	16			
13.1	Quality information	16			
14	Package outline	17			
15	Handling information	19			
16	Soldering of SMD packages	19			
16.1	Introduction to soldering	19			
16.2	Wave and reflow soldering	19			
16.3	Wave soldering	19			
16.4	Reflow soldering	20			
17	Soldering of HVSON packages	21			

Please be aware that important notices concerning this document and the product(s) described herein, have been included in section 'Legal information'.

© NXP B.V. 2012.

All rights reserved.

For more information, please visit: <http://www.nxp.com>

For sales office addresses, please send an email to: salesaddresses@nxp.com

Date of release: 30 March 2012

Document identifier: TJA1022