

MASWSS0178

SPDT High Isolation Terminated Switch 0.01 - 3.0 GHz

Rev. V4

Features

- Positive Voltage Control: 0 / +5 V
- High Isolation: 55 dB @ 0.9 GHz
50 dB @ 1.9 GHz
- 50 Ω Internal Terminations
- Low Insertion Loss: 0.6 dB @ 0.9 GHz
0.7 dB @ 1.9 GHz
- Lead-Free MSOP-8-EP Package
- Halogen-Free "Green" Mold Compound
- 260°C Reflow Compatible
- RoHS* Compliant Version of MASWSS0024

Description

The MASWSS0178 GaAs monolithic switch provides high isolation in a lead-free, plastic surface mount package.

The MASWSS0178 is ideal for applications across a broad range of frequencies including synthesizer switching, transmit / receive switching, switch matrices and filter banks in systems such as radio and cellular equipment, PCS, GPS, and fiber optic modules.

M/A-COM Technology fabricates the MASWSS0178 using a 1.0-micron gate length MESFET process. The process features full chip passivation for performance and reliability.

Ordering Information ¹

Part Number	Package
MASWSS0178	Bulk Packaging
MASWSS0178TR-3000	3000 piece reel
MASWSS0178SMB	Sample Board

1. Reference Application Note M513 for reel size information.

Functional Schematic ²

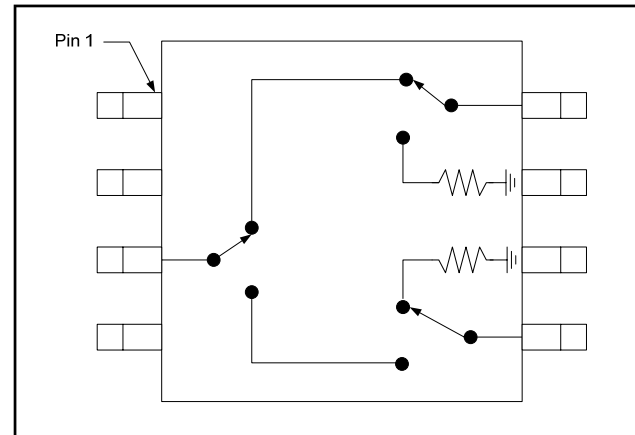

2. The exposed pad centered on the package bottom must be connected to RF and DC ground.

Pin Configuration

Pin No.	Function	Pin No.	Function
1	Control 1	5	RF Port 2
2	Control 2	6	Ground
3	RF Common	7	Ground
4	Ground	8	RF Port 1

Absolute Maximum Ratings ^{3,4}

Parameter	Absolute Maximum
Input Power (0.5 - 3.0 GHz) 3 V Control 5 V Control	+30 dBm +33 dBm
Operating Voltage	+8.5 Volts
Operating Temperature	-40°C to +85°C
Storage Temperature	-65°C to +150°C

3. Exceeding any one or combination of these limits may cause permanent damage to this device.
4. M/A-COM Technology does not recommend sustained operation near these survivability limits.

* Restrictions on Hazardous Substances, European Union Directive 2002/95/EC.

1

ADVANCED: Data Sheets contain information regarding a product M/A-COM Technology Solutions is considering for development. Performance is based on target specifications, simulated results, and/or prototype measurements. Commitment to develop is not guaranteed.
PRELIMINARY: Data Sheets contain information regarding a product M/A-COM Technology Solutions has under development. Performance is based on engineering tests. Specifications are typical. Mechanical outline has been fixed. Engineering samples and/or test data may be available. Commitment to produce in volume is not guaranteed.

• **North America** Tel: 800.366.2266 • **Europe** Tel: +353.21.244.6400
• **India** Tel: +91.80.43537383 • **China** Tel: +86.21.2407.1588
Visit www.macomtech.com for additional data sheets and product information.

M/A-COM Technology Solutions Inc. and its affiliates reserve the right to make changes to the product(s) or information contained herein without notice.

SPDT High Isolation Terminated Switch 0.01 - 3.0 GHz

Rev. V4

Electrical Specifications: $T_A = 25^\circ\text{C}$, $V_C = 0\text{ V} / 5\text{ V}$, $Z_0 = 50\ \Omega$ ⁵

Parameter	Test Conditions	Units	Min.	Typ.	Max.
Insertion Loss	0.01 - 0.5 GHz	dB	—	0.5	—
	0.5 - 1.0 GHz		—	0.6	0.7
	1.0 - 2.0 GHz		—	0.7	0.8
	2.0 - 3.0 GHz		—	0.75	—
Isolation	0.01 - 0.5 GHz	dB	—	59	—
	0.5 - 1.0 GHz		51	57	—
	1.0 - 2.0 GHz		44	53	—
	2.0 - 3.0 GHz		—	43	—
Return Loss	0.01 - 0.5 GHz ⁶	dB	—	20	—
	0.5 - 1.0 GHz		—	20	—
	1.0 - 2.0 GHz		—	20	—
	2.0 - 3.0 GHz		—	20	—
Input IP ₂	2-Tone, 900 MHz, 5 MHz spacing	dBm	—	83	—
Input IP ₃	2-Tone, 900 MHz, 5 MHz spacing	dBm	—	43	—
Input P1dB Compression	$V_C = 0\text{ V}/5.0\text{ V}$, 1 GHz	dBm	—	29	—
	$V_C = 0\text{ V}/3.0\text{ V}$, 1 GHz		—	17.5	—
Trise, Tfall	10% to 90% RF & 90% to 10% RF	ns	—	24	—
Ton, Toff	50% of V_C to 10% / 90% RF	ns	—	15	—
Transients	In-band	mV	—	12	—
Control Current	$V_C = 5\text{ V}$	μA	—	2	13

5. External DC blocking capacitors are required on all RF ports (47 pF capacitors are recommended). Use larger value capacitors for lower frequency operation (e.g. use 10,000 pF capacitors to optimize insertion and return loss at frequencies below 50 MHz).

6. Terminated return loss is governed by blocking capacitors internal to the device; see applications plot.

Truth Table

V1	V2	RFC-RF1	RFC-RF2
0	1	Off	On
1	0	On	Off

Logic Level	Voltage Level
V_{LOW} "0"	$0 \pm 0.2\text{ V}$
V_{HIGH} "1"	3.0 V to 8.0 V

Handling Procedures

Please observe the following precautions to avoid damage:

Static Sensitivity

Gallium Arsenide Integrated Circuits are sensitive to electrostatic discharge (ESD) and can be damaged by static electricity. Proper ESD control techniques should be used when handling these devices.

Typical Performance Curves

Return Loss

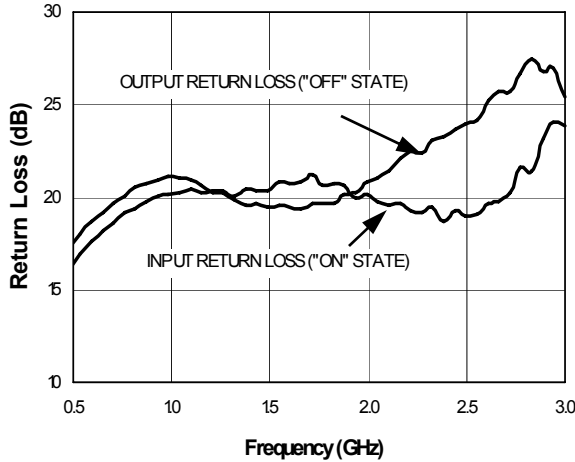

Insertion Loss

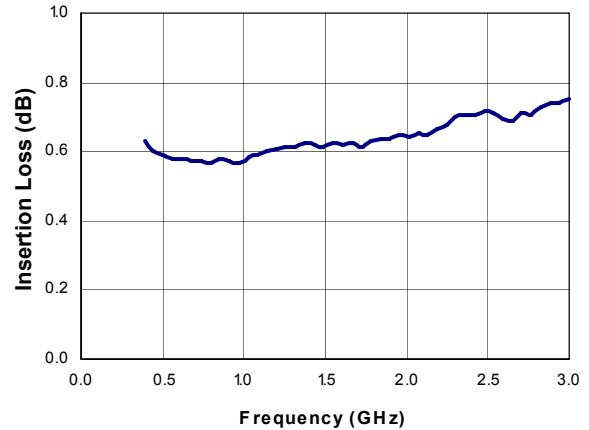

Isolation

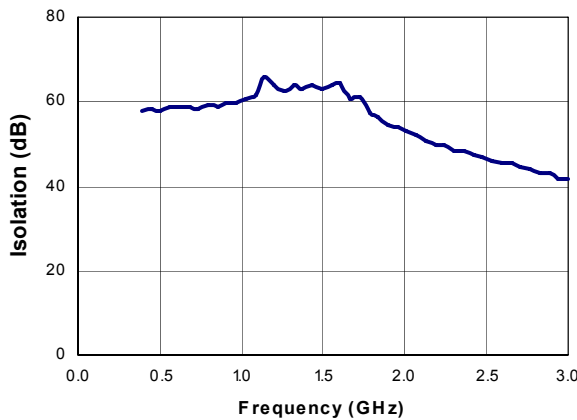

Lead-Free MSOP-8-EP†

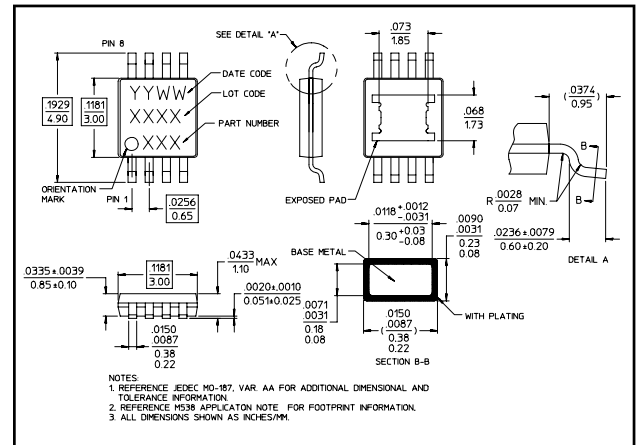

† Reference Application Note M538 for lead-free solder reflow recommendations

Meets JEDEC moisture sensitivity level 1 requirements.
Plating is 100% matte tin over copper.

Applications Section

Typical Performance Curves, Very Low Frequency, 10000 pF Blocking Capacitors

Return Loss vs. Frequency

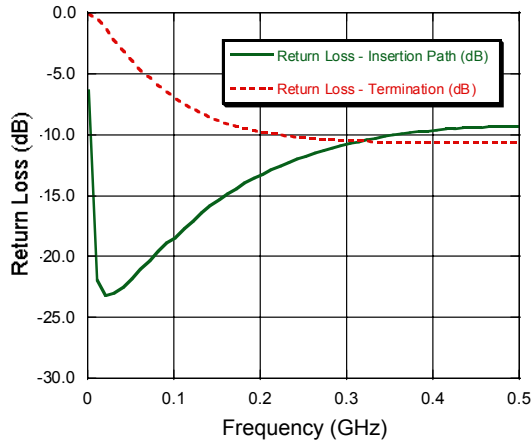

Insertion Loss vs. Frequency

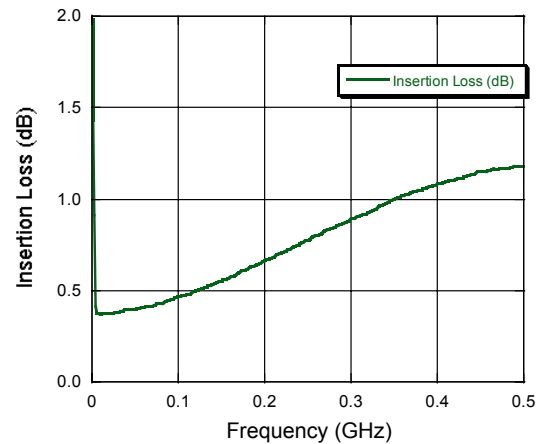

Isolation vs. Frequency

