

Features

- Combination of 120V NPN Darlington Transistor and 120V Rectifier Diode
- High Current Gain: $h_{FE} = 2000\text{min}$ @ $V_{CE} = 2V$, $I_C = 1A$
- **Totally Lead-Free & Fully RoHS Compliant (Notes 1 & 2)**
- **Halogen and Antimony Free. "Green" Device (Note 3)**

Application

- Printer Head Driver

Mechanical Data

- Case: V-DFN3030-8
- UL Flammability Rating 94V-0
- Case Material: Molded Plastic. "Green" Molding Compound. Moisture Sensitivity: Level 1 per J-STD-020
- Terminals: Finish — NiPdAu over Copper Leadframe. Solderable per MIL-STD-202, Method 208
- Weight: 0.02 grams (Approximate)

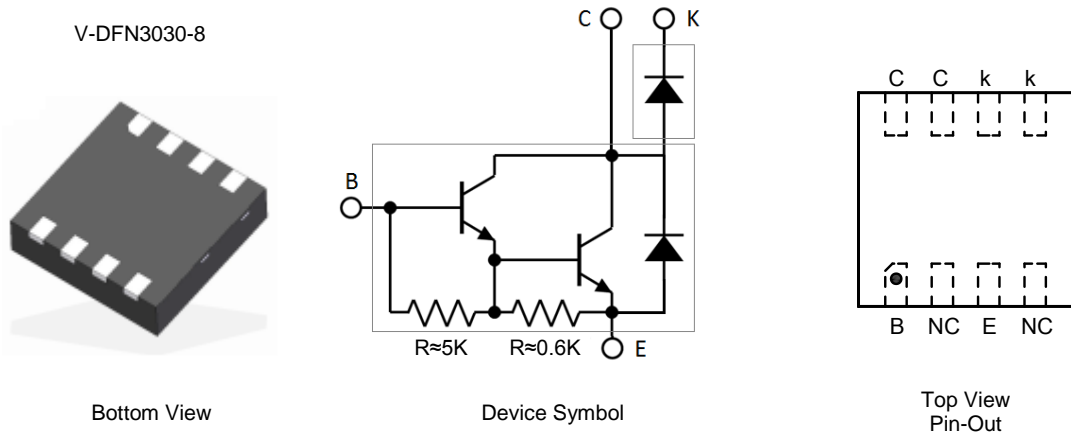

Ordering Information (Note 4)

Product	Marking	Reel Size (inches)	Tape Width (mm)	Quantity per Reel
ZXPD4000DH-7	1T9	7	8	3,000

- Notes:
1. No purposely added lead. Fully EU Directive 2002/95/EC (RoHS), 2011/65/EU (RoHS 2) & 2015/863/EU (RoHS 3) compliant.
 2. See <https://www.diodes.com/quality/lead-free/> for more information about Diodes Incorporated's definitions of Halogen- and Antimony-free, "Green" and Lead-free.
 3. Halogen- and Antimony-free "Green" products are defined as those which contain <900ppm bromine, <900ppm chlorine (<1500ppm total Br + Cl) and <1000ppm antimony compounds.
 4. For packaging details, go to our website at <https://www.diodes.com/design/support/packaging/diodes-packaging/>.

Marking Information

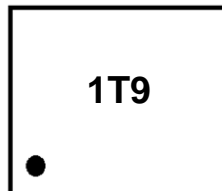

1T9 = Product Type Marking Code

BJT Absolute Maximum Ratings (@T_A = +25°C, unless otherwise specified.)

Characteristic	Symbol	Value	Unit
Collector-Base Voltage	V _{CB0}	120	V
Collector-Emitter Voltage	V _{CEO}	120	V
Emitter-Base Voltage	V _{EBO}	8	V
Continuous Collector Current	I _C	2	A
Peak Collector Current	I _{CP}	3	A
Base Current	I _B	0.5	A

Diode Absolute Maximum Ratings (@T_A = +25°C, unless otherwise specified.)

Characteristic	Symbol	Value	Unit
Repetitive Peak Reverse Voltage	V _R RM	120	V
Average Current	I _{F(AV)}	1	A
Non-Repetitive Peak Forward Current (Surge Current), 1 Cycle (50Hz)	I _{FSM}	15	A

Thermal Characteristics (@T_A = +25°C, unless otherwise specified.)

Characteristic	Symbol	Value	Unit
Power Dissipation (Note 5)	P _D	0.9	W
Power Dissipation (Note 6)	P _D	0.72	W
Thermal Resistance, Junction to Ambient (Note 5)	R _{θJA}	139	°C/W
Thermal Resistance, Junction to Ambient (Note 6)	R _{θJA}	172	°C/W
Operating and Storage Temperature Range	T _J , T _{STG}	-55 to +150	°C

ESD Ratings (Note 7)

Characteristic	Symbol	Value	Unit	JEDEC Class
Electrostatic Discharge – Human Body Model	ESD HBM	4,000	V	3A
Electrostatic Discharge – Machine Model	ESD MM	400	V	C

- Notes:
5. For a device surface mounted on 25mm X 25mm X 1.6mm FR-4 PCB with high coverage of single sided 1 oz copper, in still air conditions.
 6. Same as Note 5, except the device is mounted on minimum recommended pad layout.
 7. Refer to JEDEC specification JESD22-A114 and JESD22-A115.

BJT Electrical Characteristics (@T_A = +25°C, unless otherwise specified.)

Characteristic	Symbol	Min	Typ	Max	Unit	Test Condition
Collector Cutoff Current	I _{CBO}	-	-	10	μA	V _{CB} = 120V, I _E = 0
Emitter Cutoff Current	I _{EBO}	1	-	2.67	mA	V _{EB} = 8V, I _C = 0
Collector-Emitter Breakdown Voltage	BV _{CEO}	120	-	-	V	I _C = 10mA, I _B = 0
DC Current Gain	h _{FE}	2000	-	9000	-	V _{CE} = 2V, I _C = 1A
Collector-Emitter Saturation Voltage	V _{CE(sat)}	-	-	1.5	V	I _C = 1A, I _B = 1mA
Base-Emitter Saturation Voltage	V _{BE(sat)}	-	-	2	V	I _C = 1A, I _B = 1mA
Output Capacitance	C _{obo}	-	12	-	pF	V _{CB} = 10V, I _E = 0, f = 1MHz
Delay Time	t _D	-	0.34	-	μs	V _{CC} = 30V, R _L = 30Ω, I _{B1} = -I _{B2} = 1mA
Rise Time	t _R	-	1.8	-	μs	
Storage time	t _{STG}	-	0.2	-	μs	
Fall Time	t _F	-	0.15	-	μs	

Diode Electrical Characteristics (@T_A = +25°C, unless otherwise specified.)

Characteristic	Symbol	Min	Typ	Max	Unit	Test Condition
Peak Forward Voltage	V _{FM}	-	-	0.98	V	I _{FM} = 1 A
Reverse Leakage Current	I _R	-	-	10	μA	V _R = 120V
Reverse Recovery Time	t _{RR}	-	300	450	ns	I _F = 1A, di/dt = -20A/μs
Forward Recovery Time	t _{FR}	-	150	300	ns	I _F = 1A

BJT Typical Electrical Characteristics (@ $T_A = +25^\circ\text{C}$, unless otherwise specified.)

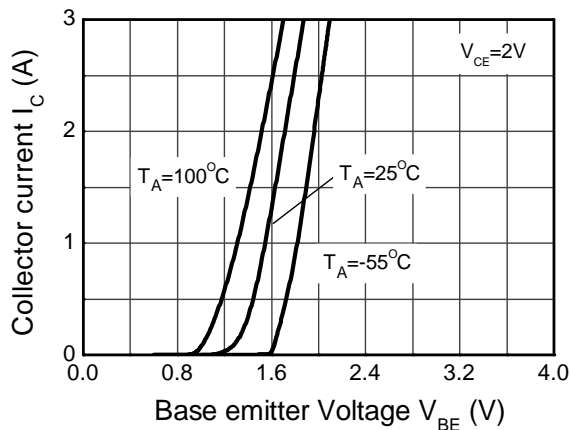
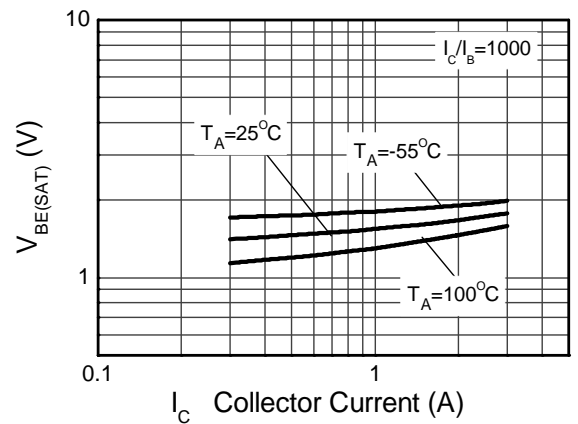
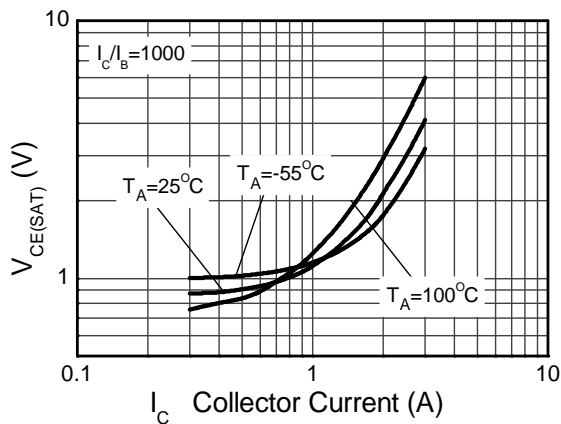
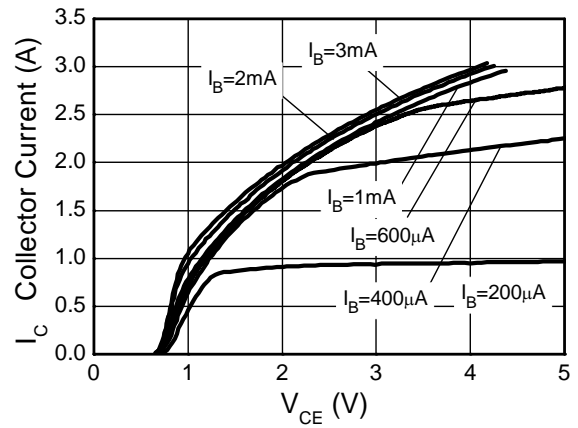
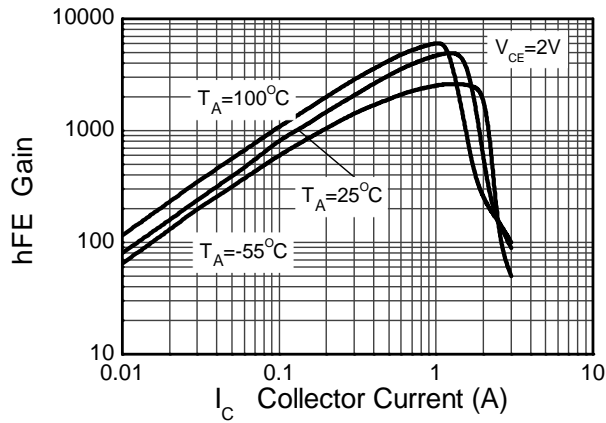

BJT Typical Electrical Characteristics (@ $T_A = +25^\circ\text{C}$, unless otherwise specified.)

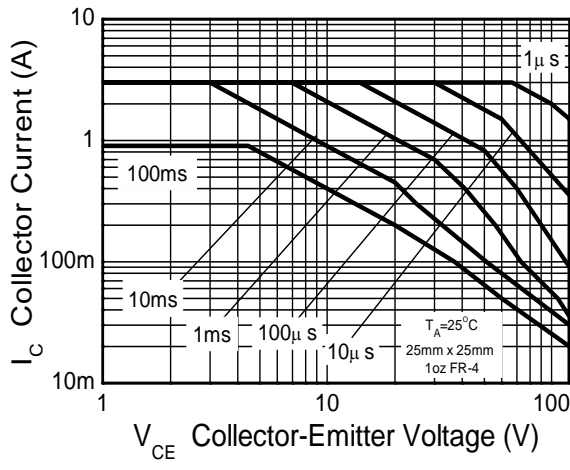

Forward Bias Safe operating Area

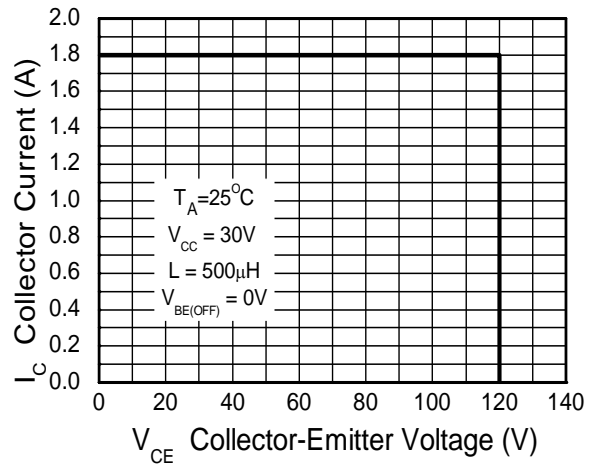

Reverse Bias Safe operating Area

Package Outline Dimensions

Please see <http://www.diodes.com/package-outlines.html> for the latest version.

V-DFN3030-8

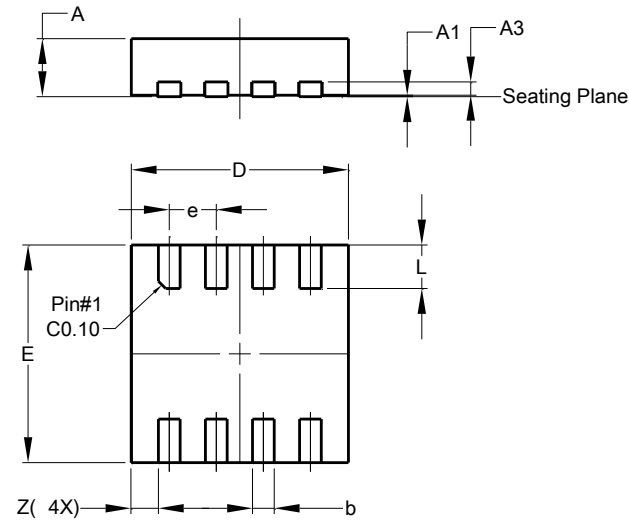

V-DFN3030-8			
Dim	Min	Max	Typ
A	0.75	0.85	0.80
A1	0.00	0.05	0.02
A3	-	-	0.203
b	0.25	0.35	0.30
D	2.95	3.05	3.00
E	2.95	3.05	3.00
e	-	-	0.65
L	0.55	0.65	0.60
Z	-	-	0.375
All Dimensions in mm			

Suggested Pad Layout

Please see <http://www.diodes.com/package-outlines.html> for the latest version.

V-DFN3030-8

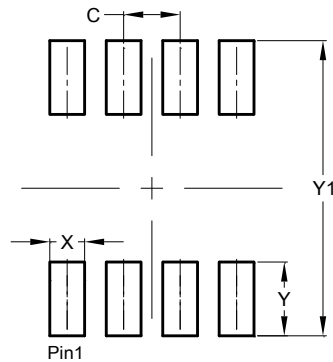

Dimensions	Value (in mm)
C	0.650
X	0.400
Y	0.850
Y1	3.400

IMPORTANT NOTICE

DIODES INCORPORATED MAKES NO WARRANTY OF ANY KIND, EXPRESS OR IMPLIED, WITH REGARDS TO THIS DOCUMENT, INCLUDING, BUT NOT LIMITED TO, THE IMPLIED WARRANTIES OF MERCHANTABILITY AND FITNESS FOR A PARTICULAR PURPOSE (AND THEIR EQUIVALENTS UNDER THE LAWS OF ANY JURISDICTION).

Diodes Incorporated and its subsidiaries reserve the right to make modifications, enhancements, improvements, corrections or other changes without further notice to this document and any product described herein. Diodes Incorporated does not assume any liability arising out of the application or use of this document or any product described herein; neither does Diodes Incorporated convey any license under its patent or trademark rights, nor the rights of others. Any Customer or user of this document or products described herein in such applications shall assume all risks of such use and will agree to hold Diodes Incorporated and all the companies whose products are represented on Diodes Incorporated website, harmless against all damages.

Diodes Incorporated does not warrant or accept any liability whatsoever in respect of any products purchased through unauthorized sales channel. Should Customers purchase or use Diodes Incorporated products for any unintended or unauthorized application, Customers shall indemnify and hold Diodes Incorporated and its representatives harmless against all claims, damages, expenses, and attorney fees arising out of, directly or indirectly, any claim of personal injury or death associated with such unintended or unauthorized application.

Products described herein may be covered by one or more United States, international or foreign patents pending. Product names and markings noted herein may also be covered by one or more United States, international or foreign trademarks.

LIFE SUPPORT

Diodes Incorporated products are specifically not authorized for use as critical components in life support devices or systems without the express written approval of the Chief Executive Officer of Diodes Incorporated. As used herein:

- A. Life support devices or systems are devices or systems which:
 - 1. are intended to implant into the body, or
 - 2. support or sustain life and whose failure to perform when properly used in accordance with instructions for use provided in the labeling can be reasonably expected to result in significant injury to the user.
- B. A critical component is any component in a life support device or system whose failure to perform can be reasonably expected to cause the failure of the life support device or to affect its safety or effectiveness.

Customers represent that they have all necessary expertise in the safety and regulatory ramifications of their life support devices or systems, and acknowledge and agree that they are solely responsible for all legal, regulatory and safety-related requirements concerning their products and any use of Diodes Incorporated products in such safety-critical, life support devices or systems, notwithstanding any devices- or systems-related information or support that may be provided by Diodes Incorporated. Further, Customers must fully indemnify Diodes Incorporated and its representatives against any damages arising out of the use of Diodes Incorporated products in such safety-critical, life support devices or systems.

Copyright © 2019, Diodes Incorporated

www.diodes.com