

REV.	DESCRIPTION	DATE	APPROVED
J	Added SLP3-150-200-R and SLP3-150-300-F	10/11/13	G. W.
K	Added Color Options, Sheet #2	02/02/16	J. C.

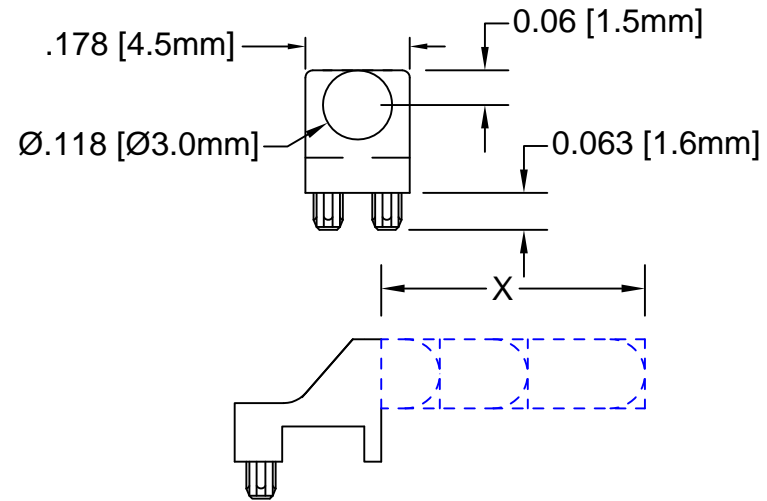

PART NUMBER	Y DIMENSION
SLP3-150-100-F	0.100 [2.54mm] Flat Face
SLP3-150-100-R	0.100 [2.54mm] Round Face
SLP3-150-150-F	0.150 [3.81mm] Flat Face
SLP3-150-150-R	0.150 [3.81mm] Round Face
SLP3-150-200-R	0.200 [5.08mm] Round Face
SLP3-150-250-F	0.250 [6.35mm] Flat Face
SLP3-150-250-R	0.250 [6.35mm] Round Face
SLP3-150-300-F	0.300 [7.62mm] Flat Face
SLP3-150-300-R	0.300 [7.62mm] Round Face
SLP3-150-450-R	0.450 [11.43mm] Round Face

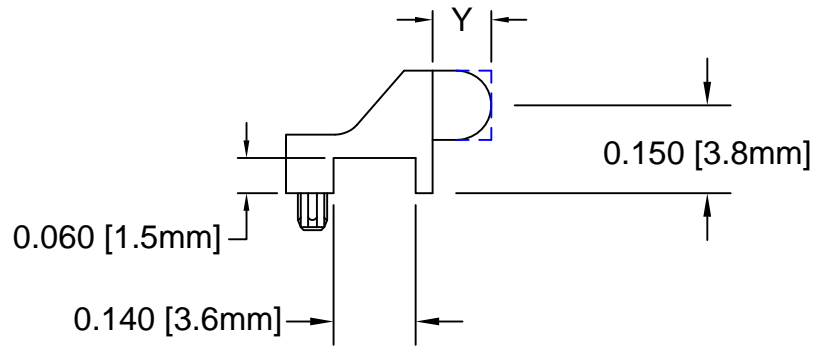
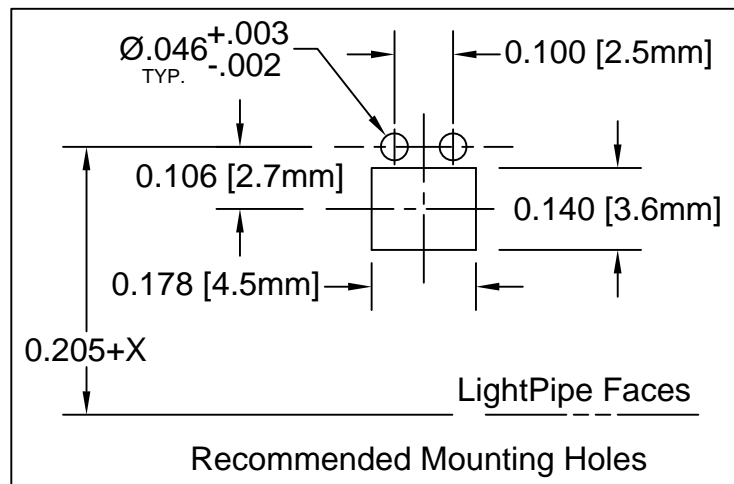
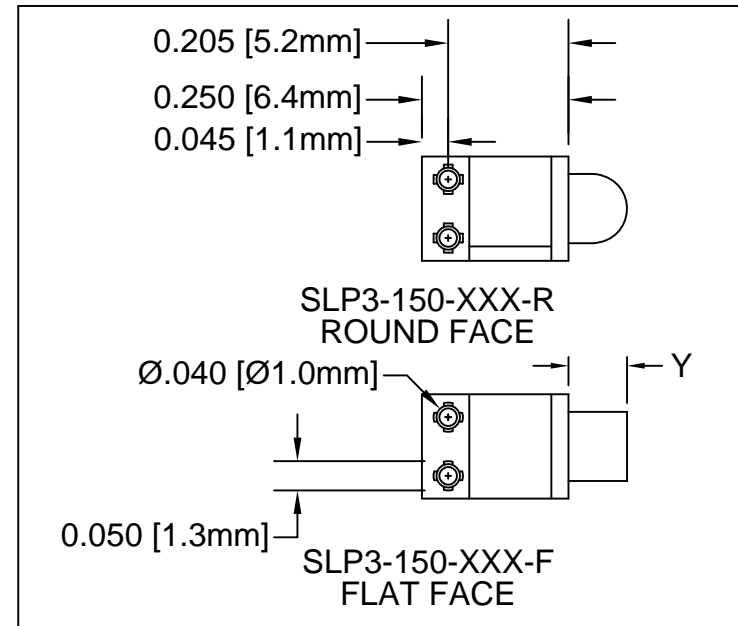

3. ALL DIMENSIONS ARE IN INCHES UNLESS OTHERWISE SPECIFIED
2. MATERIAL: POLYCARBONATE, 94V-0, CLEAR.
1. GENERAL SPECIFICATIONS: BIVAR MOLDED COMPONENT SPECIFICATION BV00-E101.

STANDARD TOLERANCE (UNLESS OTHERWISE SPECIFIED)		BIVAR®	
DECIMALS	ANGULAR	4 THOMAS, IRVINE, CA. 92618	
.X ± .1	X° ± 1°	TEL: (949) 951-8808 FAX: (949) 951-3974	
.XX ± .01		TITLE: LIGHT PIPE	
.XXX ± .005		90° VARIABLE CENTERLINE	
DESIGNED: Ty Yin	DATE: 10/17/07	PART NO: SLP3-150-XXX-X	REVISION: K
CHECKED: M. Chen	DATE: 10/17/07	CAGE CODE : 32559	SHEET # 1 OF 2
CAD GENERATED DOCUMENT. DO NOT MEASURE DRAWING.			

OTHER AVAILABLE COLORS

* SEE TABLE FOR ORDERING INFORMATION

REV.	DESCRIPTION	DATE	APPROVED
	SEE SHEET #1		

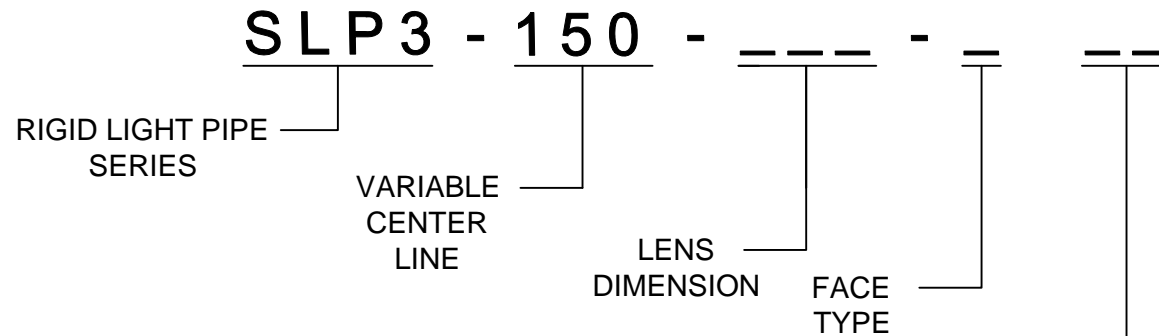

COLOR	Order Code
BLUE	BE
BLACK	BK
GREEN	GN
GRAY	GY
RED	RD
YELLOW	YW

NOTE: LEAVE ORDER CODE BLANK IF NO COLOR IS DESIRED.

4. PARTS ARE DYED TO COLOR UPON REQUEST.

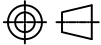
STANDARD TOLERANCE (UNLESS OTHERWISE SPECIFIED) DECIMALS ANGULAR		 4 THOMAS, IRVINE, CA. 92618 TEL: (949) 951-8808 FAX: (949) 951-3974	
			
DESIGNED: K. Aukshunas	DATE: 01/25/16	TITLE: LIGHT PIPE 90° VARIABLE CENTERLINE	
CHECKED: J. Chiang	DATE: 01/25/16	PART NO: SLP3-150-XXX-X	REVISION: K
		CAGE CODE : 32559	SHEET # 2 OF 2
CAD GENERATED DOCUMENT. DO NOT MEASURE DRAWING.			