

| REV. | DESCRIPTION | DATE | APPROVED |
|------|---|----------|----------|
| J | Added SLP3-150-200-R and SLP3-150-300-F | 10/11/13 | G. W. |
| K | Added Color Options, Sheet #2 | 02/02/16 | J. C. |

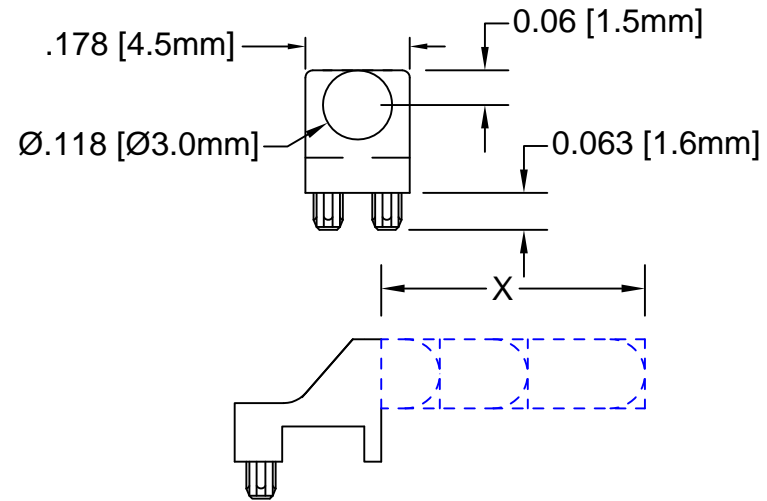

| PART NUMBER | Y DIMENSION |
|----------------|----------------------------|
| SLP3-150-100-F | 0.100 [2.54mm] Flat Face |
| SLP3-150-100-R | 0.100 [2.54mm] Round Face |
| SLP3-150-150-F | 0.150 [3.81mm] Flat Face |
| SLP3-150-150-R | 0.150 [3.81mm] Round Face |
| SLP3-150-200-R | 0.200 [5.08mm] Round Face |
| SLP3-150-250-F | 0.250 [6.35mm] Flat Face |
| SLP3-150-250-R | 0.250 [6.35mm] Round Face |
| SLP3-150-300-F | 0.300 [7.62mm] Flat Face |
| SLP3-150-300-R | 0.300 [7.62mm] Round Face |
| SLP3-150-450-R | 0.450 [11.43mm] Round Face |

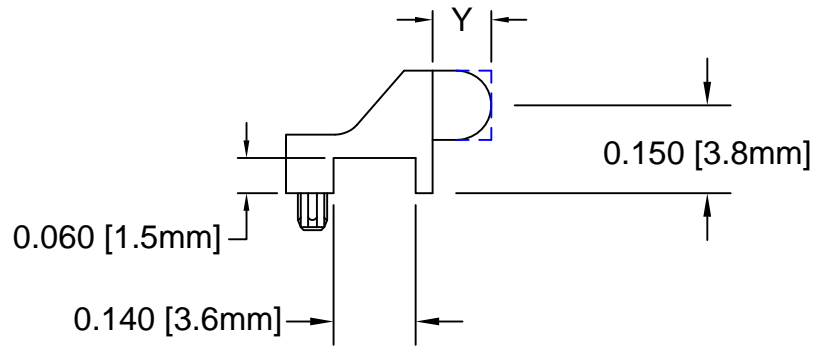
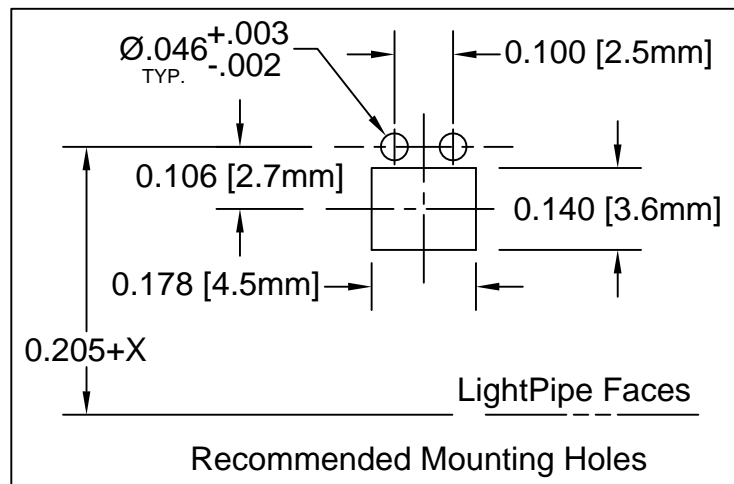
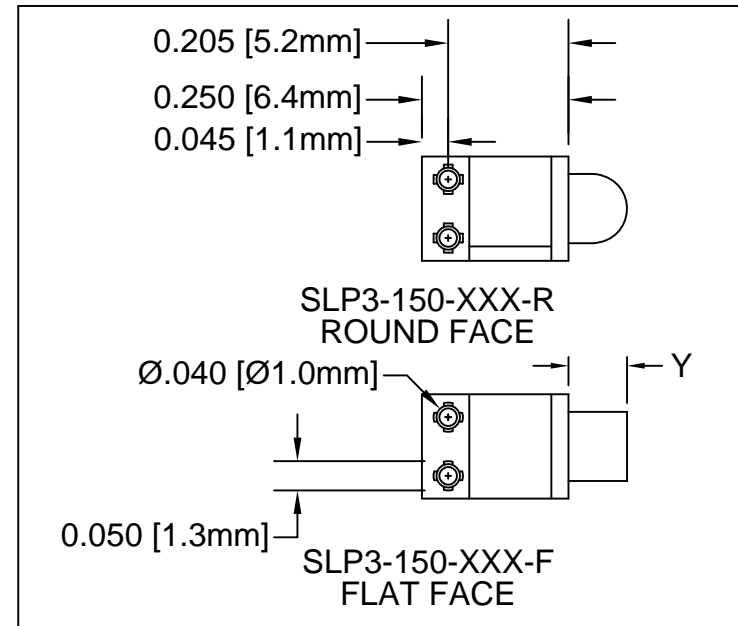

| STANDARD TOLERANCE (UNLESS OTHERWISE SPECIFIED) | | BIVAR® | |
|---|----------------|---|----------------|
| DECIMALS | ANGULAR | 4 THOMAS, IRVINE, CA. 92618 | |
| .X ± .1 | X° ± 1° | TEL: (949) 951-8808 FAX: (949) 951-3974 | |
| .XX ± .01 | | TITLE: LIGHT PIPE | |
| .XXX ± .005 | | 90° VARIABLE CENTERLINE | |
| DESIGNED: Ty Yin | DATE: 10/17/07 | PART NO: SLP3-150-XXX-X | REVISION: K |
| CHECKED: M. Chen | DATE: 10/17/07 | CAGE CODE: 32559 | SHEET # 1 OF 2 |
| CAD GENERATED DOCUMENT. DO NOT MEASURE DRAWING. | | | |

3. ALL DIMENSIONS ARE IN INCHES UNLESS OTHERWISE SPECIFIED
2. MATERIAL: POLYCARBONATE, 94V-0, CLEAR.
1. GENERAL SPECIFICATIONS: BIVAR MOLDED COMPONENT SPECIFICATION BV00-E101.

OTHER AVAILABLE COLORS

* SEE TABLE FOR ORDERING INFORMATION

| REV. | DESCRIPTION | DATE | APPROVED |
|------|--------------|------|----------|
| | SEE SHEET #1 | | |
| | | | |
| | | | |
| | | | |

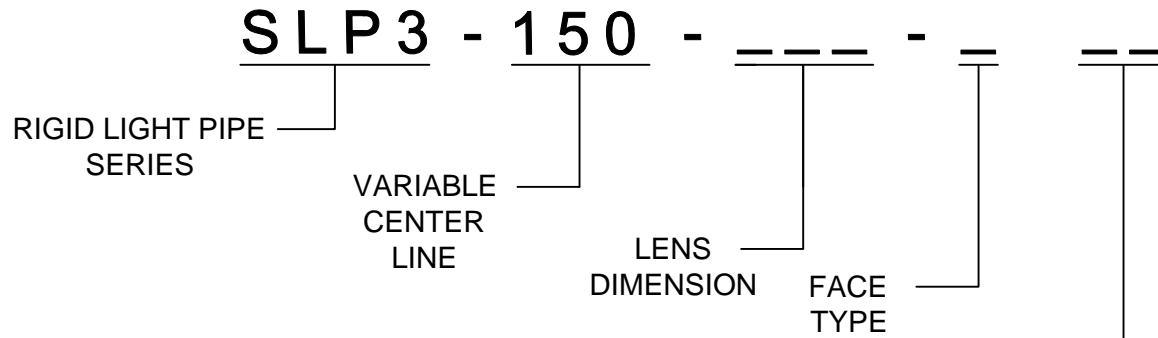

| COLOR | Order Code |
|--------|------------|
| BLUE | BE |
| BLACK | BK |
| GREEN | GN |
| GRAY | GY |
| RED | RD |
| YELLOW | YW |

NOTE: LEAVE ORDER CODE BLANK IF NO COLOR IS DESIRED.

4. PARTS ARE DYED TO COLOR UPON REQUEST.

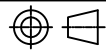
| | | | |
|---|--------------------------|--|------------------------------|
| STANDARD TOLERANCE (UNLESS OTHERWISE SPECIFIED) DECIMALS ANGULAR | |  4 THOMAS, IRVINE, CA. 92618 TEL: (949) 951-8808 FAX: (949) 951-3974 | |
|  | | | |
| DESIGNED: K. Aukshunas | DATE: 01/25/16 | TITLE: LIGHT PIPE 90° VARIABLE CENTERLINE | |
| CHECKED: J. Chiang | DATE: 01/25/16 | PART NO: SLP3-150-XXX-X | REVISION: K |
| | | CAGE CODE : 32559 | SHEET # 2 OF 2 |
| CAD GENERATED DOCUMENT. DO NOT MEASURE DRAWING. | | | |