

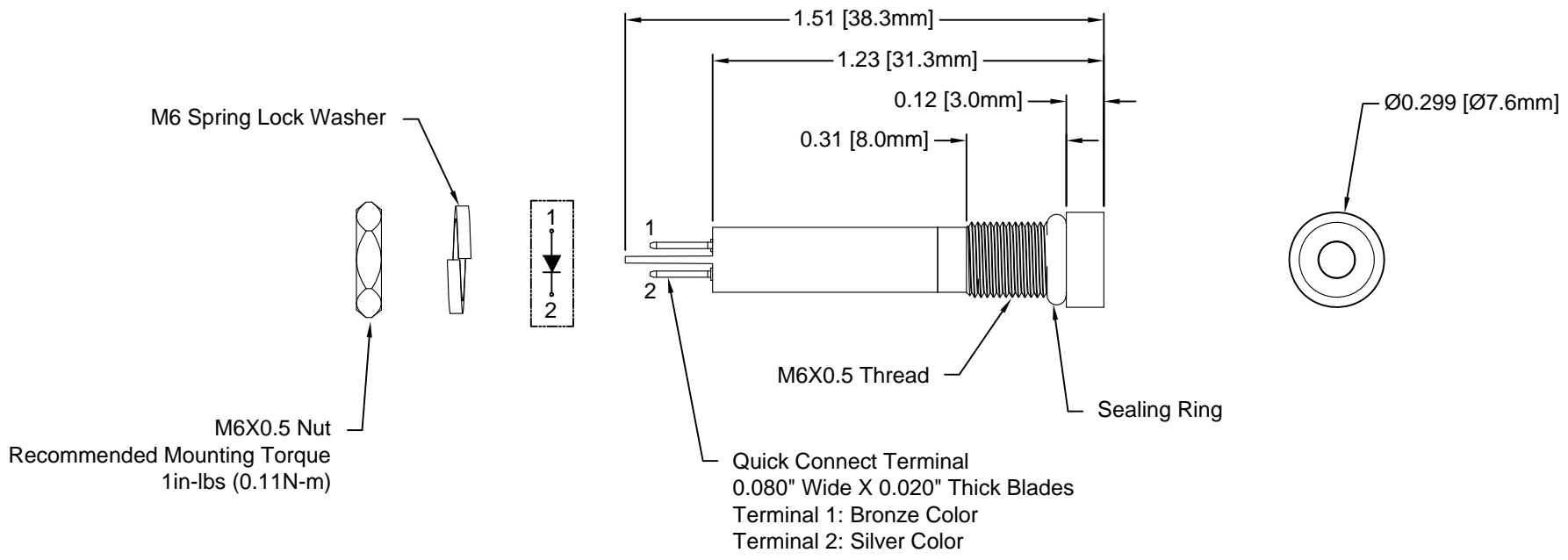

REV.	DESCRIPTION	DATE	APPROVED
A	Engineering Release	08/18/14	J. C.
B	Engineering Update w/o Changes	08/11/16	J. C.
C	Removed P/N Per EOL NOTICE 052317	07/24/17	J. C.

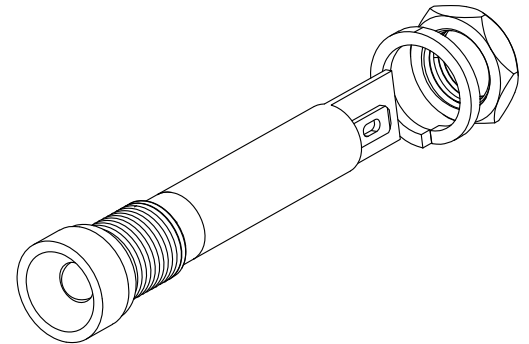

M6X0.5 Nut  
Recommended Mounting Torque  
1in-lbs (0.11N-m)

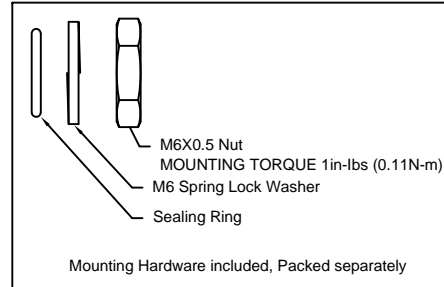
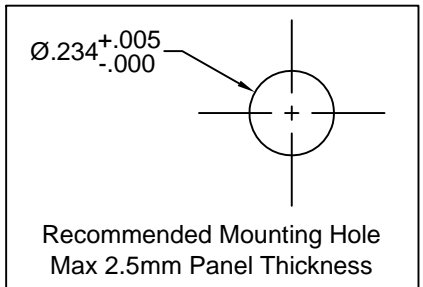

- NOTES:**
1. SEALED TO IP54 RATING
  2. VOLTAGE INPUT OPTIONS: 12V/24V
  3. ROHS COMPLIANT
  4. MOUNTING HARDWARE PACKED SEPARATELY NON-ASSEMBLED
  5. INSERT SEALING RING ON PANEL MOUNT ASSEMBLY PRIOR TO PANEL INSTALLATION

STANDARD TOLERANCE (UNLESS OTHERWISE SPECIFIED)		 4 THOMAS, IRVINE, CA. 92618 TEL: (949) 951-8808 FAX: (949) 951-3974	
DECIMALS	ANGULAR		
.X ± .1	X° ± 1°		TITLE: MPR6-3 SERIES, IP54 RATED PANEL MOUNT INDICATOR
.XX ± .02			PART NO: MPR6-3XDXXV
.XXX ± .010			REVISION: C
DESIGNED: <b>M. Doan</b>	DATE: <b>08/18/14</b>	CAGE CODE : 32559	SHEET # 1 OF 2
CHECKED: <b>B. Oliver</b>	DATE: <b>08/18/14</b>	CAD GENERATED DOCUMENT. DO NOT MEASURE DRAWING.	

REV.	DESCRIPTION	DATE	APPROVED
	SEE SHEET #1		

Part Number	Dominant Wave Length $\lambda_d$ (nm)	Emitted Color	Lens Appearance	Voltage	Luminous Intensity (mcd)	Viewing Angle (degree)
MPR6-3RD12V	625	Red	Diffused	12V	310	45
MPR6-3GD12V	525	Green	Diffused	12V	2090	45
MPR6-3YD12V	590	Yellow	Diffused	12V	520	45
MPR6-3BWD12V	465	Blue	Diffused	12V	310	45
MPR6-3WD12V	x=0.28, y=0.30	White	Diffused	12V	2610	45
MPR6-3RD24V	625	Red	Diffused	24V	310	45
MPR6-3GD24V	525	Green	Diffused	24V	2090	45
MPR6-3YD24V	590	Yellow	Diffused	24V	520	45
MPR6-3BWD24V	465	Blue	Diffused	24V	310	45
MPR6-3WD24V	x=0.28, y=0.30	White	Diffused	24V	2610	45

**ABSOLUTE MAXIMUM RATINGS (Ta = 25°C)**

POWER INPUT \_\_\_\_\_ 0.5W MAX  
 OPERATING TEMPERATURE RANGE \_\_\_\_\_ -40°C ~ 80°C  
 STORAGE TEMPERATURE \_\_\_\_\_ -40°C ~ 80°C  
 TERMINAL SOLDERING TEMPERATURE \_\_\_\_\_ 260°C, 5s

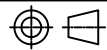
STANDARD TOLERANCE ( UNLESS OTHERWISE SPECIFIED ) DECIMALS                      ANGULAR		 4 THOMAS, IRVINE, CA. 92618 TEL: (949) 951-8808    FAX: (949) 951-3974	
			
DESIGNED: <b>M. Doan</b>	DATE: <b>08/18/14</b>	<b>TITLE:</b> MPR6-3 SERIES, IP54 RATED PANEL MOUNT INDICATOR	
CHECKED: <b>B. Oliver</b>	DATE: <b>08/18/14</b>	<b>PART NO:</b> <b>MPR6-3XDXXV</b>	<b>REVISION:</b> <b>C</b>
		<b>CAGE CODE :</b> 32559	<b>SHEET #</b> 2 <b>OF</b> 2
CAD GENERATED DOCUMENT. DO NOT MEASURE DRAWING.			