

## DS90CF384AQ +3.3V LVDS Receiver 24-Bit Flat Panel Display (FPD) Link - 65 MHz

Check for Samples: [DS90CF384AQ](#)

### FEATURES

- Automotive Grade Device, AEC-Q100 Grade 3 Qualified
- Operating Temperature Range:  $-40^{\circ}\text{C}$  to  $+85^{\circ}\text{C}$
- 20 to 65 MHz Shift Clock Support
- 50% Duty Cycle on Receiver Output Clock
- Best-in-Class Set & Hold Times on RxOUTPUTs
- Rx Power Consumption  $<142\text{ mW}$  (typ) @65MHz Grayscale
- Rx Power-down Mode  $<200\mu\text{W}$  (max)
- ESD Rating  $>7\text{ kV}$  (HBM),  $>700\text{V}$  (EIAJ)
- Supports VGA, SVGA, XGA and Dual Pixel SXGA.
- PLL Requires No External Components

- Compatible with TIA/EIA-644 LVDS Standard
- Low Profile 56-Lead TSSOP Package

### DESCRIPTION

The DS90CF384AQ receiver converts the four LVDS data streams at up to 1.8 Gbps throughput (227 Megabytes/sec bandwidth) back into parallel 28 bits of LVCMOS/LVTTL data. In a Display application, the 28 bits include: 24 bits of RGB data and up to 4 bits of video control (Hsync, Vsync, DE and CNTL).

The DS90CF384AQ device is enhanced over prior generation FPD-Link receivers, provides a wider data valid time on the receiver output and is offered as an AEC-Q100 grade 3 device.

FPD-Link is an ideal means to solve EMI and cable size problems associated with wide, high speed LVCMOS/LVTTL interfaces.

### Block Diagram

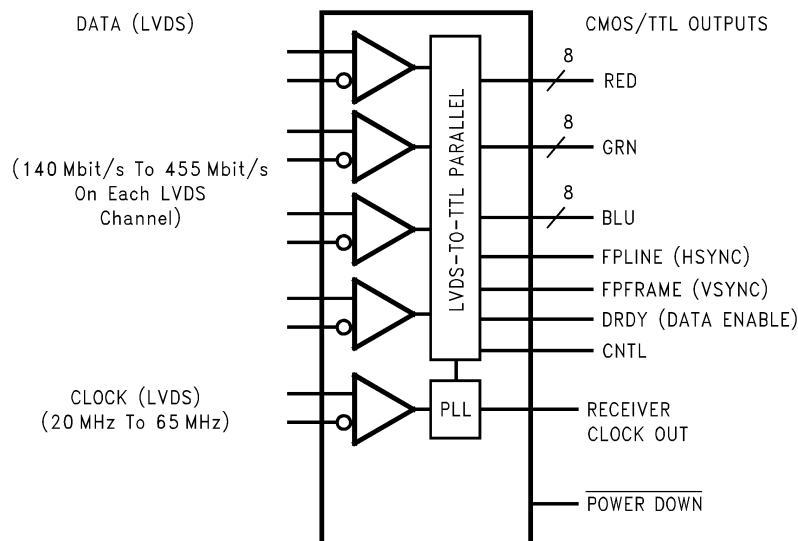

Figure 1. DS90CF384AQ Block Diagram



Please be aware that an important notice concerning availability, standard warranty, and use in critical applications of Texas Instruments semiconductor products and disclaimers thereto appears at the end of this data sheet.

All trademarks are the property of their respective owners.

### Absolute Maximum Ratings<sup>(1)(2)</sup>

Supply Voltage ( $V_{CC}$ )		-0.3V to +4V
LVC MOS/LVTTL Input Voltage		-0.3V to ( $V_{CC} + 0.3V$ )
LVC MOS/LVTTL Output Voltage		-0.3V to ( $V_{CC} + 0.3V$ )
LVDS Receiver Input Voltage		-0.3V to ( $V_{CC} + 0.3V$ )
Junction Temperature		+150°C
Storage Temperature		-65°C to +150°C
For soldering specifications: see <a href="http://www.ti.com/lit/SNOA549">http://www.ti.com/lit/SNOA549</a>		
Maximum Package Power Dissipation Capacity @ 25°C		
DGG Package:		1.61 W
DGG Package Derating:		12.4 mW/°C above +25°C
ESD Rating	(HBM, 1.5 kΩ, 100 pF)	> 7 kV
	(EIAJ, 0Ω, 200 pF)	> 700V

- (1) If Military/Aerospace specified devices are required, please contact the TI Sales Office/ Distributors for availability and specifications.  
(2) "Absolute Maximum Ratings" are those values beyond which the safety of the device cannot be ensured. They are not meant to imply that the device should be operated at these limits. The "Electrical Characteristics" specify conditions for device operation.

### Recommended Operating Conditions

	Min	Nom	Max	Units
Supply Voltage ( $V_{CC}$ )	3.0	3.3	3.6	V
Operating Free Air Temperature ( $T_A$ )	-40	+25	+85	°C
Receiver Input Range	0		2.4	V
Supply Noise Voltage ( $V_{CC}$ )			100	mV <sub>PP</sub>

### Electrical Characteristics

Over recommended operating supply and temperature ranges unless otherwise specified.

Symbol	Parameter	Conditions	Min	Typ <sup>(1)</sup>	Max	Units	
<b>LVC MOS/LVTTL DC SPECIFICATIONS (For Power Down Pin)</b>							
$V_{IH}$	High Level Input Voltage		2.0		$V_{CC}$	V	
$V_{IL}$	Low Level Input Voltage		GND		0.8	V	
$V_{CL}$	Input Clamp Voltage	$I_{CL} = -18$ mA		-0.79	-1.5	V	
$I_{IN}$	Input Current	$V_{IN} = 0.4V, 2.5V$ or $V_{CC}$		+1.8	+10	μA	
		$V_{IN} = GND$	-10	0		μA	
<b>LVC MOS/LVTTL DC SPECIFICATIONS</b>							
$V_{OH}$	High Level Output Voltage	$I_{OH} = -0.4$ mA	2.7	3.3		V	
$V_{OL}$	Low Level Output Voltage	$I_{OL} = 2$ mA		0.06	0.3	V	
$I_{OS}$	Output Short Circuit Current	$V_{OUT} = 0V$		-60	-120	mA	
<b>LVDS RECEIVER DC SPECIFICATIONS</b>							
$V_{TH}$	Differential Input High Threshold	$V_{CM} = +1.2V$			+100	mV	
$V_{TL}$	Differential Input Low Threshold		-100			mV	
$I_{IN}$	Input Current	$V_{IN} = +2.4V, V_{CC} = 3.6V$			±10	μA	
		$V_{IN} = 0V, V_{CC} = 3.6V$			±10	μA	
<b>RECEIVER SUPPLY CURRENT<sup>(2)</sup></b>							
ICCRW	Receiver Supply Current Worst Case	$C_L = 8$ pF, Worst Case Pattern (Figure 2 and Figure 4)	$f = 32.5$ MHz		49	65	mA
			$f = 37.5$ MHz		53	70	mA
			$f = 65$ MHz		81	105	mA

(1) Typical values are given for  $V_{CC} = 3.3V$  and  $T_A = +25C$ .

(2) Current into device pins is defined as positive. Current out of device pins is defined as negative. Voltages are referenced to ground unless otherwise specified (except  $V_{OD}$  and  $\Delta V_{OD}$ ).

## Electrical Characteristics (continued)

Over recommended operating supply and temperature ranges unless otherwise specified.

Symbol	Parameter	Conditions	Min	Typ <sup>(1)</sup>	Max	Units
ICCRG	Receiver Supply Current, 16 Grayscale	C <sub>L</sub> = 8 pF, 16 Grayscale Pattern (Figure 3 and Figure 4)	f = 32.5 MHz	28		mA
			f = 37.5 MHz	30		mA
			f = 65 MHz	43		mA
ICCRZ	Receiver Supply Current Power Down	Power Down = Low, Receiver Outputs Stay Low during Power Down Mode		10	55	μA

## Receiver Switching Characteristics

Over recommended operating supply and temperature ranges unless otherwise specified

Symbol	Parameter	Min	Typ	Max	Units	
CLHT	CMOS/TTL Low-to-High Transition Time (Figure 4)		2	5	ns	
CHLT	CMOS/TTL High-to-Low Transition Time (Figure 4)		1.8	5	ns	
RSPos0	Receiver Input Strobe Position for Bit 0 (Figure 10)	f = 25 MHz	1.20	1.96	2.82	ns
RSPos1	Receiver Input Strobe Position for Bit 1		6.91	7.67	8.53	ns
RSPos2	Receiver Input Strobe Position for Bit 2		12.62	13.38	14.24	ns
RSPos3	Receiver Input Strobe Position for Bit 3		18.33	19.09	19.95	ns
RSPos4	Receiver Input Strobe Position for Bit 4		24.04	24.80	25.66	ns
RSPos5	Receiver Input Strobe Position for Bit 5		29.75	30.51	31.37	ns
RSPos6	Receiver Input Strobe Position for Bit 6		35.46	36.22	37.08	ns
RSPos0	Receiver Input Strobe Position for Bit 0 (Figure 10)	f = 65 MHz	0.7	1.1	1.4	ns
RSPos1	Receiver Input Strobe Position for Bit 1		2.9	3.3	3.6	ns
RSPos2	Receiver Input Strobe Position for Bit 2		5.1	5.5	5.8	ns
RSPos3	Receiver Input Strobe Position for Bit 3		7.3	7.7	8.0	ns
RSPos4	Receiver Input Strobe Position for Bit 4		9.5	9.9	10.2	ns
RSPos5	Receiver Input Strobe Position for Bit 5		11.7	12.1	12.4	ns
RSPos6	Receiver Input Strobe Position for Bit 6		13.9	14.3	14.6	ns
RSKM	RxIN Skew Margin <sup>(1)</sup> (Figure 11)	f = 25 MHz	750			ps
		f = 65 MHz	500			ps
RCOP	RxCLK OUT Period (Figure 5)	15	T	50	ns	
RCOH	RxCLK OUT High Time (Figure 5)	f = 65 MHz	5.0	7.6	9.0	ns
RCOL	RxCLK OUT Low Time (Figure 5)		5.0	6.3	9.0	ns
RSRC	RxOUT Setup to RxCLK OUT (Figure 5)		4.5	7.3		ns
RHRC	RxOUT Hold to RxCLK OUT (Figure 5)		4.0	6.3		ns
RCCD	RxCLK IN to RxCLK OUT Delay @ 25°C, V <sub>CC</sub> = 3.3V (Figure 6)		3.5	5.0	7.5	ns
RPLLS	Receiver Phase Lock Loop Set (Figure 7)			10	ms	
RPDD	Receiver Power Down Delay (Figure 9)			1	μs	

- (1) Receiver Skew Margin is defined as the valid data sampling region at the receiver inputs. This margin takes into account the DS90C383B transmitter pulse positions (min and max) and the receiver input setup and hold time (internal data sampling window - RSPos). The RSKM will change when different transmitters are used. This margin allows for LVDS interconnect skew, inter-symbol interference (both dependent on type/length of cable), and clock jitter (less than 250 ps).

### AC Timing Diagrams

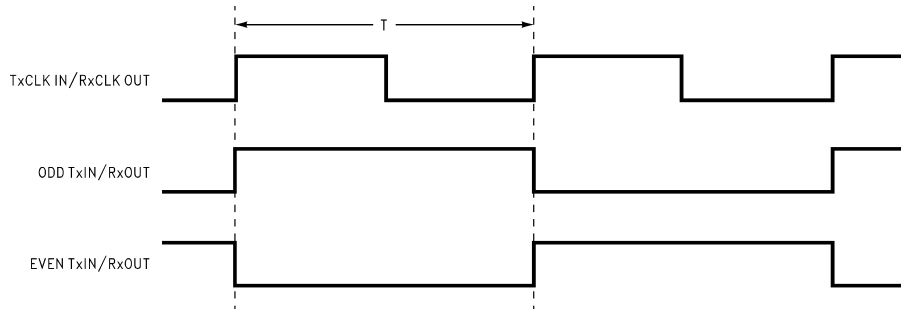
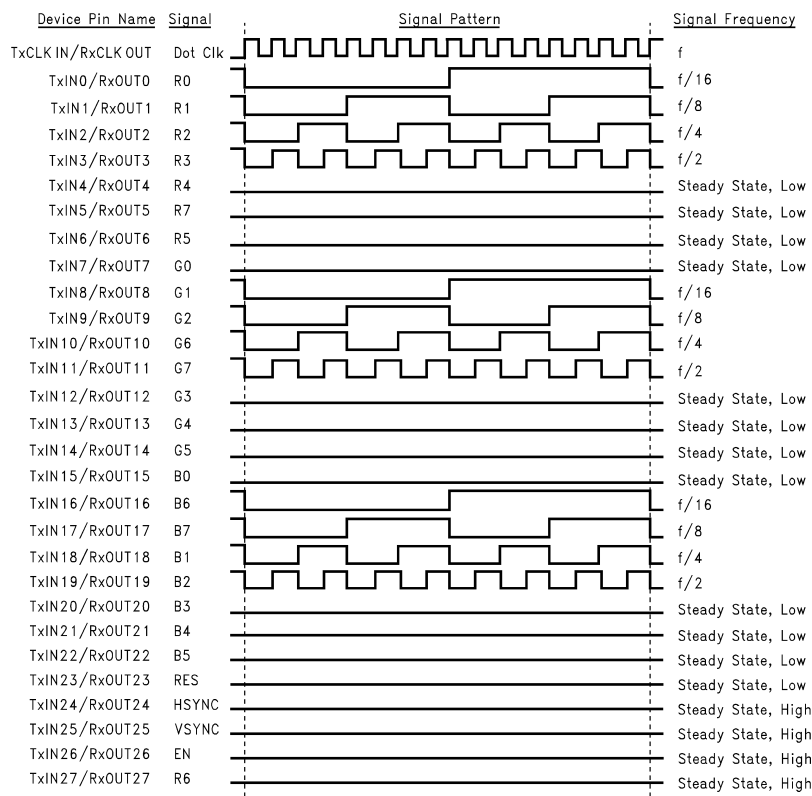

Figure 2. "Worst Case" Test Pattern



The worst case test pattern produces a maximum toggling of digital circuits, LVDS I/O and CMOS/TTL I/O.

The 16 grayscale test pattern tests device power consumption for a "typical" LCD display pattern. The test pattern approximates signal switching needed to produce groups of 16 vertical stripes across the display.

Figure 2 and Figure 3 show a falling edge data strobe (TxCLK IN / RxCLK OUT).

Recommended pin to signal mapping. Application may choose to define differently, check compatibility with source.

Figure 3. "16 Grayscale" Test Pattern



Figure 4. Receiver CMOS/TTL Output Load and Transition Times

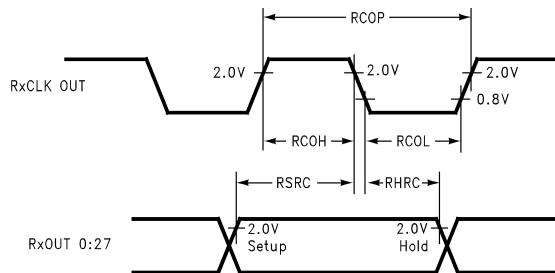

Figure 5. Receiver Output Setup/Hold and High/Low Times

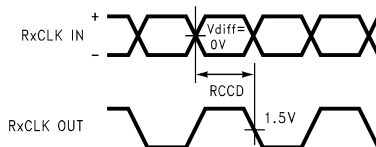

Figure 6. Receiver Clock In to Clock Out Delay

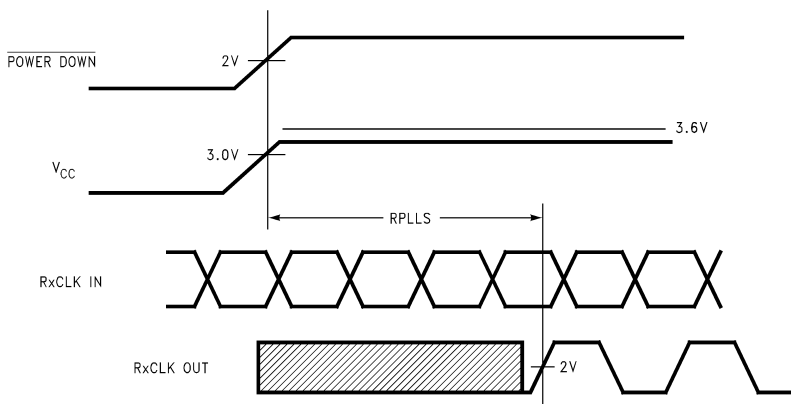

Figure 7. Receiver Phase Lock Loop Set Time

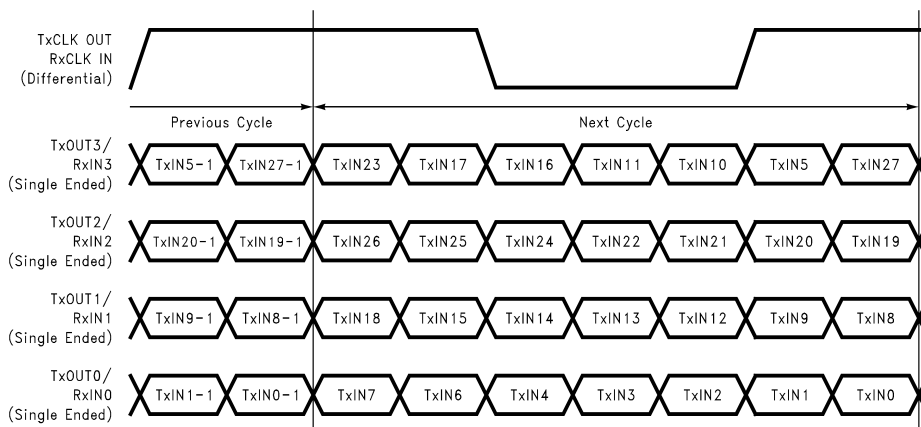

Figure 8. 28 Parallel TTL Data Inputs/Outputs Mapped to LVDS Bits (TxINn / RxOUTn)

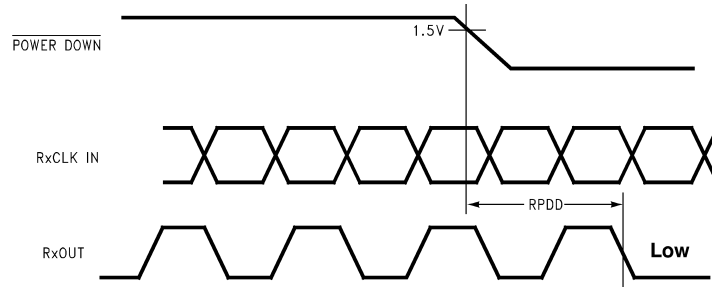

Figure 9. Receiver Power Down Delay

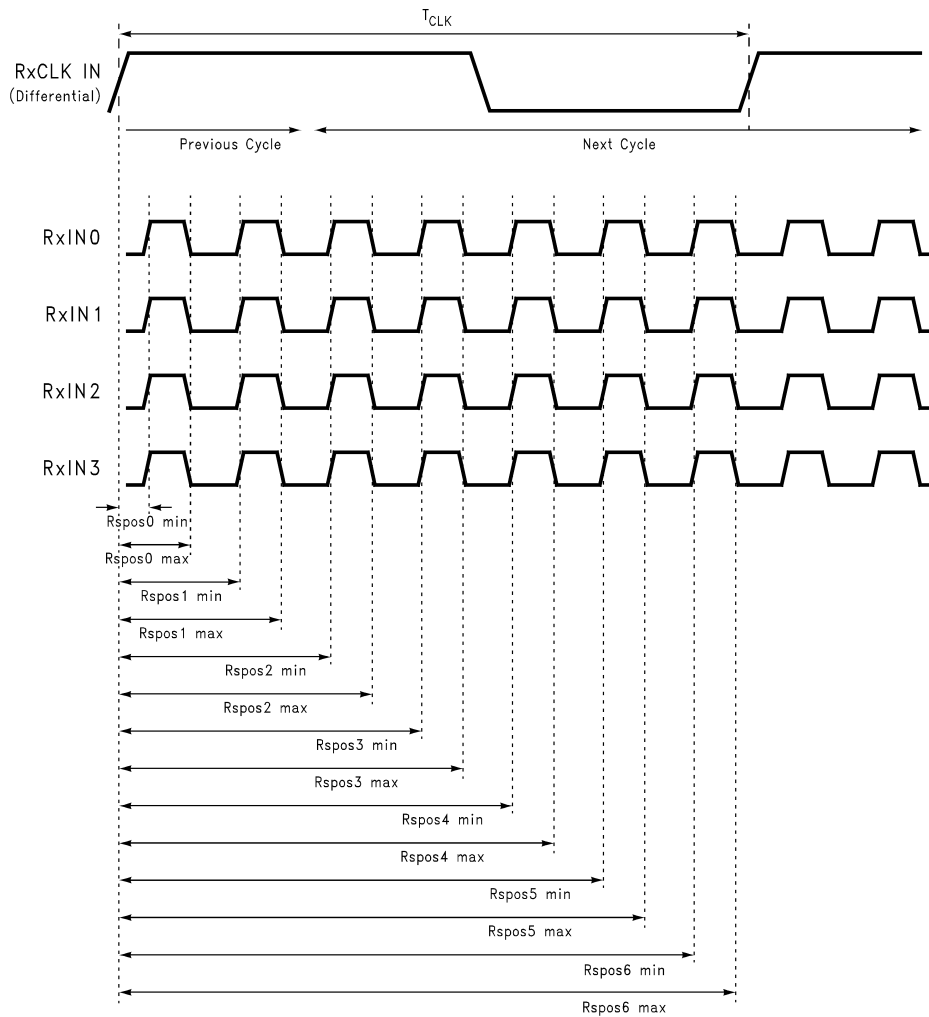
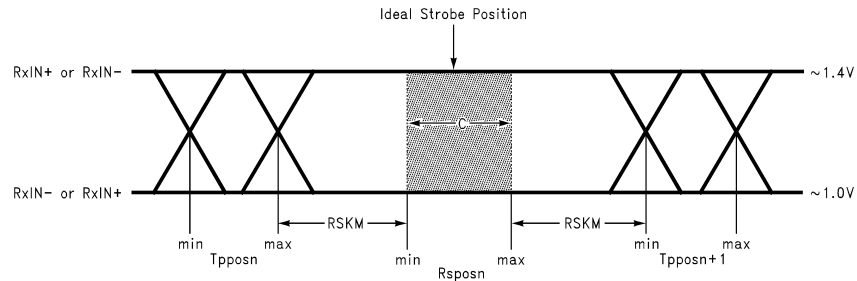

Figure 10. Receiver LVDS Input Strobe Position



C—Setup and Hold Time (Internal data sampling window) defined by Rspostn (receiver input strobe position) min and max

Tpposn—Transmitter output pulse position (min and max)

RSKM = Cable Skew (type, length) + Source Clock Jitter (cycle to cycle) + ISI (Inter-symbol interference)

Cable Skew—typically 10 ps–40 ps per foot, media dependent

Cycle-to-cycle jitter is less than 250 ps at 65 MHz.

ISI is dependent on interconnect length; may be zero.

**Figure 11. Receiver LVDS Input Skew Margin**

## DS90CF384AQ Pin Descriptions — 56L TSSOP Package

Pin Name	I/O	No.	Description
RxIN+	I	4	Positive LVDS differential data inputs.
RxIN-	I	4	Negative LVDS differential data inputs.
RxOUT	O	28	TTL level data outputs. This includes: 8 Red, 8 Green, 8 Blue, and 3 control lines—FPLINE, FPFRAME, DRDY (also referred to as HSYNC, VSYNC, Data Enable).
RxCLK IN+	I	1	Positive LVDS differential clock input.
RxCLK IN-	I	1	Negative LVDS differential clock input.
RxCLK OUT	O	1	TTL level clock output. The falling edge acts as data strobe.
$\overline{\text{PWR DOWN}}$	I	1	TTL level input. When asserted (low input) the receiver outputs are low.
V <sub>CC</sub>	I	4	Power supply pins for TTL outputs.
GND	I	5	Ground pins for TTL outputs.
PLL V <sub>CC</sub>	I	1	Power supply for PLL.
PLL GND	I	2	Ground pin for PLL.
LVDS V <sub>CC</sub>	I	1	Power supply pin for LVDS inputs.
LVDS GND	I	3	Ground pins for LVDS inputs.

Pin Diagram for TSSOP Package

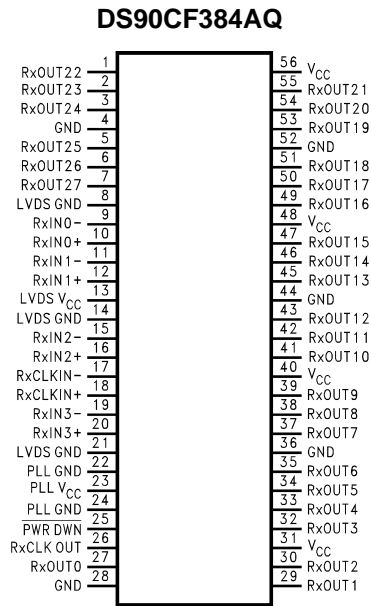

Figure 12. 56-Lead TSSOP (DGG Package)



**PACKAGING INFORMATION**

Orderable Device	Status (1)	Package Type	Package Drawing	Pins	Package Qty	Eco Plan (2)	Lead/Ball Finish	MSL Peak Temp (3)	Op Temp (°C)	Top-Side Markings (4)	Samples
DS90CF384AQM/NOPB	ACTIVE	TSSOP	DGG	56	34	Green (RoHS & no Sb/Br)	CU SN	Level-2-260C-1 YEAR	-40 to 85	DS90CF384AQ MT	<a href="#">Samples</a>
DS90CF384AQMTX/NOPB	ACTIVE	TSSOP	DGG	56	1000	Green (RoHS & no Sb/Br)	CU SN	Level-2-260C-1 YEAR	-40 to 85	DS90CF384AQ MT	<a href="#">Samples</a>

(1) The marketing status values are defined as follows:

**ACTIVE:** Product device recommended for new designs.

**LIFEBUY:** TI has announced that the device will be discontinued, and a lifetime-buy period is in effect.

**NRND:** Not recommended for new designs. Device is in production to support existing customers, but TI does not recommend using this part in a new design.

**PREVIEW:** Device has been announced but is not in production. Samples may or may not be available.

**OBSOLETE:** TI has discontinued the production of the device.

(2) Eco Plan - The planned eco-friendly classification: Pb-Free (RoHS), Pb-Free (RoHS Exempt), or Green (RoHS & no Sb/Br) - please check <http://www.ti.com/productcontent> for the latest availability information and additional product content details.

**TBD:** The Pb-Free/Green conversion plan has not been defined.

**Pb-Free (RoHS):** TI's terms "Lead-Free" or "Pb-Free" mean semiconductor products that are compatible with the current RoHS requirements for all 6 substances, including the requirement that lead not exceed 0.1% by weight in homogeneous materials. Where designed to be soldered at high temperatures, TI Pb-Free products are suitable for use in specified lead-free processes.

**Pb-Free (RoHS Exempt):** This component has a RoHS exemption for either 1) lead-based flip-chip solder bumps used between the die and package, or 2) lead-based die adhesive used between the die and leadframe. The component is otherwise considered Pb-Free (RoHS compatible) as defined above.

**Green (RoHS & no Sb/Br):** TI defines "Green" to mean Pb-Free (RoHS compatible), and free of Bromine (Br) and Antimony (Sb) based flame retardants (Br or Sb do not exceed 0.1% by weight in homogeneous material)

(3) MSL, Peak Temp. -- The Moisture Sensitivity Level rating according to the JEDEC industry standard classifications, and peak solder temperature.

(4) Only one of markings shown within the brackets will appear on the physical device.

**Important Information and Disclaimer:** The information provided on this page represents TI's knowledge and belief as of the date that it is provided. TI bases its knowledge and belief on information provided by third parties, and makes no representation or warranty as to the accuracy of such information. Efforts are underway to better integrate information from third parties. TI has taken and continues to take reasonable steps to provide representative and accurate information but may not have conducted destructive testing or chemical analysis on incoming materials and chemicals. TI and TI suppliers consider certain information to be proprietary, and thus CAS numbers and other limited information may not be available for release.

In no event shall TI's liability arising out of such information exceed the total purchase price of the TI part(s) at issue in this document sold by TI to Customer on an annual basis.

## TAPE AND REEL INFORMATION



### QUADRANT ASSIGNMENTS FOR PIN 1 ORIENTATION IN TAPE



\*All dimensions are nominal

Device	Package Type	Package Drawing	Pins	SPQ	Reel Diameter (mm)	Reel Width W1 (mm)	A0 (mm)	B0 (mm)	K0 (mm)	P1 (mm)	W (mm)	Pin1 Quadrant
DS90CF384AQM-TX/NOPB	TSSOP	DGG	56	1000	330.0	24.4	8.6	14.5	1.8	12.0	24.0	Q1

**TAPE AND REEL BOX DIMENSIONS**



\*All dimensions are nominal

Device	Package Type	Package Drawing	Pins	SPQ	Length (mm)	Width (mm)	Height (mm)
DS90CF384AQMXX/NOPB	TSSOP	DGG	56	1000	367.0	367.0	45.0

DGG (R-PDSO-G\*\*)

PLASTIC SMALL-OUTLINE PACKAGE

48 PINS SHOWN



- NOTES: A. All linear dimensions are in millimeters.  
 B. This drawing is subject to change without notice.  
 C. Body dimensions do not include mold protrusion not to exceed 0,15.  
 D. Falls within JEDEC MO-153

## IMPORTANT NOTICE

Texas Instruments Incorporated and its subsidiaries (TI) reserve the right to make corrections, enhancements, improvements and other changes to its semiconductor products and services per JESD46, latest issue, and to discontinue any product or service per JESD48, latest issue. Buyers should obtain the latest relevant information before placing orders and should verify that such information is current and complete. All semiconductor products (also referred to herein as "components") are sold subject to TI's terms and conditions of sale supplied at the time of order acknowledgment.

TI warrants performance of its components to the specifications applicable at the time of sale, in accordance with the warranty in TI's terms and conditions of sale of semiconductor products. Testing and other quality control techniques are used to the extent TI deems necessary to support this warranty. Except where mandated by applicable law, testing of all parameters of each component is not necessarily performed.

TI assumes no liability for applications assistance or the design of Buyers' products. Buyers are responsible for their products and applications using TI components. To minimize the risks associated with Buyers' products and applications, Buyers should provide adequate design and operating safeguards.

TI does not warrant or represent that any license, either express or implied, is granted under any patent right, copyright, mask work right, or other intellectual property right relating to any combination, machine, or process in which TI components or services are used. Information published by TI regarding third-party products or services does not constitute a license to use such products or services or a warranty or endorsement thereof. Use of such information may require a license from a third party under the patents or other intellectual property of the third party, or a license from TI under the patents or other intellectual property of TI.

Reproduction of significant portions of TI information in TI data books or data sheets is permissible only if reproduction is without alteration and is accompanied by all associated warranties, conditions, limitations, and notices. TI is not responsible or liable for such altered documentation. Information of third parties may be subject to additional restrictions.

Resale of TI components or services with statements different from or beyond the parameters stated by TI for that component or service voids all express and any implied warranties for the associated TI component or service and is an unfair and deceptive business practice. TI is not responsible or liable for any such statements.

Buyer acknowledges and agrees that it is solely responsible for compliance with all legal, regulatory and safety-related requirements concerning its products, and any use of TI components in its applications, notwithstanding any applications-related information or support that may be provided by TI. Buyer represents and agrees that it has all the necessary expertise to create and implement safeguards which anticipate dangerous consequences of failures, monitor failures and their consequences, lessen the likelihood of failures that might cause harm and take appropriate remedial actions. Buyer will fully indemnify TI and its representatives against any damages arising out of the use of any TI components in safety-critical applications.

In some cases, TI components may be promoted specifically to facilitate safety-related applications. With such components, TI's goal is to help enable customers to design and create their own end-product solutions that meet applicable functional safety standards and requirements. Nonetheless, such components are subject to these terms.

No TI components are authorized for use in FDA Class III (or similar life-critical medical equipment) unless authorized officers of the parties have executed a special agreement specifically governing such use.

Only those TI components which TI has specifically designated as military grade or "enhanced plastic" are designed and intended for use in military/aerospace applications or environments. Buyer acknowledges and agrees that any military or aerospace use of TI components which have **not** been so designated is solely at the Buyer's risk, and that Buyer is solely responsible for compliance with all legal and regulatory requirements in connection with such use.

TI has specifically designated certain components as meeting ISO/TS16949 requirements, mainly for automotive use. In any case of use of non-designated products, TI will not be responsible for any failure to meet ISO/TS16949.

### Products

Audio	<a href="http://www.ti.com/audio">www.ti.com/audio</a>
Amplifiers	<a href="http://amplifier.ti.com">amplifier.ti.com</a>
Data Converters	<a href="http://dataconverter.ti.com">dataconverter.ti.com</a>
DLP® Products	<a href="http://www.dlp.com">www.dlp.com</a>
DSP	<a href="http://dsp.ti.com">dsp.ti.com</a>
Clocks and Timers	<a href="http://www.ti.com/clocks">www.ti.com/clocks</a>
Interface	<a href="http://interface.ti.com">interface.ti.com</a>
Logic	<a href="http://logic.ti.com">logic.ti.com</a>
Power Mgmt	<a href="http://power.ti.com">power.ti.com</a>
Microcontrollers	<a href="http://microcontroller.ti.com">microcontroller.ti.com</a>
RFID	<a href="http://www.ti-rfid.com">www.ti-rfid.com</a>
OMAP Applications Processors	<a href="http://www.ti.com/omap">www.ti.com/omap</a>
Wireless Connectivity	<a href="http://www.ti.com/wirelessconnectivity">www.ti.com/wirelessconnectivity</a>

### Applications

Automotive and Transportation	<a href="http://www.ti.com/automotive">www.ti.com/automotive</a>
Communications and Telecom	<a href="http://www.ti.com/communications">www.ti.com/communications</a>
Computers and Peripherals	<a href="http://www.ti.com/computers">www.ti.com/computers</a>
Consumer Electronics	<a href="http://www.ti.com/consumer-apps">www.ti.com/consumer-apps</a>
Energy and Lighting	<a href="http://www.ti.com/energy">www.ti.com/energy</a>
Industrial	<a href="http://www.ti.com/industrial">www.ti.com/industrial</a>
Medical	<a href="http://www.ti.com/medical">www.ti.com/medical</a>
Security	<a href="http://www.ti.com/security">www.ti.com/security</a>
Space, Avionics and Defense	<a href="http://www.ti.com/space-avionics-defense">www.ti.com/space-avionics-defense</a>
Video and Imaging	<a href="http://www.ti.com/video">www.ti.com/video</a>

### TI E2E Community

[e2e.ti.com](http://e2e.ti.com)