

Data Sheet

LL01CR-AU45135L46

CREE 
▶ LED Solution Provider



■ Features & Typical Applications

- High efficiency
- Optimized Uniformity
- Roadway Lighting
- Anti-glare

■ Table of Contents

| | |
|---|-----|
| General Information & Product Nomenclature..... | P.2 |
| Optical Specifications | P.3 |
| Mechanical Specifications | P.4 |
| Package Specifications | P.5 |

LL01CR-AU45135L46

General Information

- Lens Material : PCL 1225Z
- Operating Temperature range -40°C~+110°C(upper limit +120°C)
- Storage Temperature range -40°C~+110°C(upper limit +120°C)
 - * Average transmittance in visible spectrum 400nm~700nm>90%
- Usage and Maintenance:
 1. If necessary, clean lenses with mild soap, water and soft cloth.
 2. Never use any commercial cleaning solvents on lenses, like alcohol.
 3. Please handle or install lenses with wearing gloves, skin oils may damage lens or its optical characteristic.

Product Nomenclature

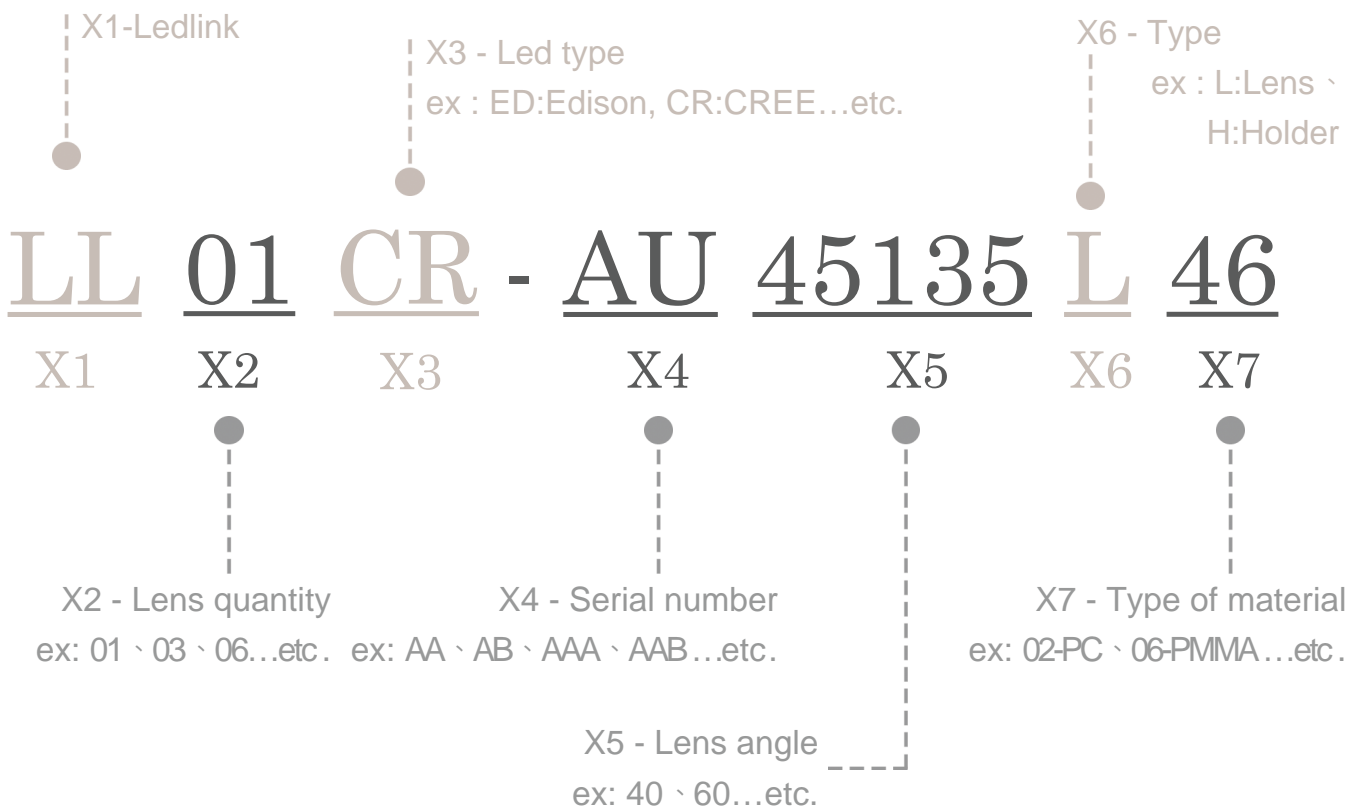

LL01CR-AU45135L46 Optical Specifications

CREE 
▶ LED Solution Provider

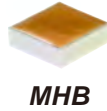

Note: (1) All the results of analysis are based on 10 degrees of elevation.
(2) Tolerance: $\pm 10\%$.
(3) Led Luminous Flux(lm): 457 ($\pm 5\%$).

IES File: [Download](#)

@elevation 0°

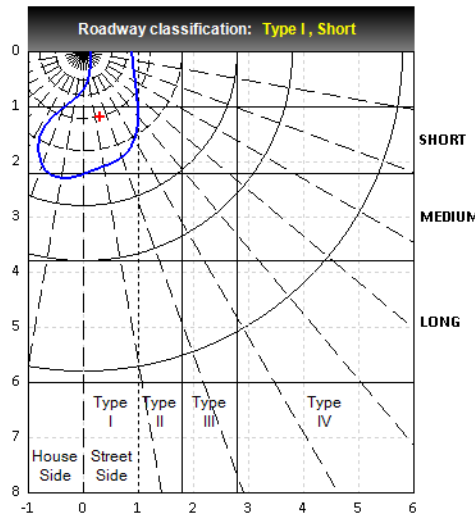
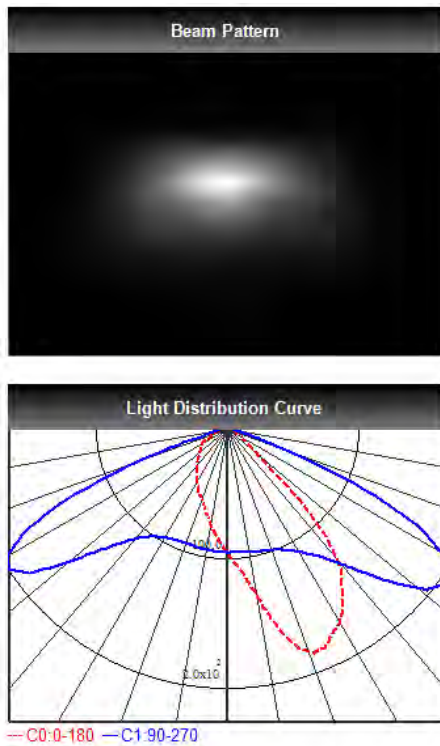

| Elevation | Roadway Classification |
|-----------|------------------------|
| 0° | Type I, Short |
| 5° | Type II, Short |
| 10° | Type II, Short |
| 15° | Type II, Short |
| 20° | Type III, Short |

DIALux Simulation Result

Analyzed file: [Download](#)

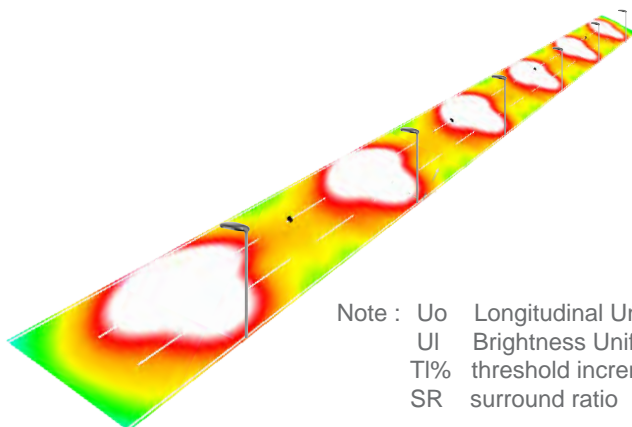

Note : Uo Longitudinal Uniformity
UI Brightness Uniformity
TI% threshold increment
SR surround ratio

| Recommend configuration condition | | |
|-----------------------------------|---|----------|
| Height | = | 10m |
| Distance | = | 40m |
| Roadwidth | = | 12m |
| Elevation | = | 0 degree |
| Overhang | = | 1.0m |
| Result | | |
| Emin / Emax | = | 0.38 |
| Emin / Eavg | = | 0.64 |
| UI | = | 0.33 |
| Uo | = | 0.47 |
| TI | = | 5% |
| SR | = | 0.6 |

*The results would be similar if the configuration conditions are equally magnified or minified.

*This testing result is obtained through testing the popular rank LED samples which provided by the original manufacturer. Hence, the testing results would be varied as the users choose same LED model but different rank.

*The analyzed file require DIALux v4.11 and above to open.

LL01CR-AU45135L46

Mechanical Specification

1. Fixing method

Glue
 Screw
 Tape
 Fixing-ring
 Frame

Note: (1) All dimensions are in mm.
 (2) All measurements are ± 0.15 mm unless otherwise indicated.

2. Lens dimension

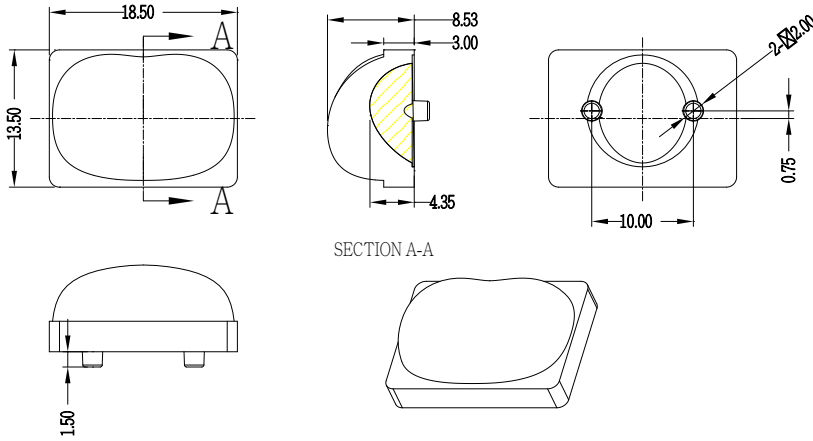

3. Assembly instruction



4. Assembly dimension

5. View assembly lens with MCPCB:

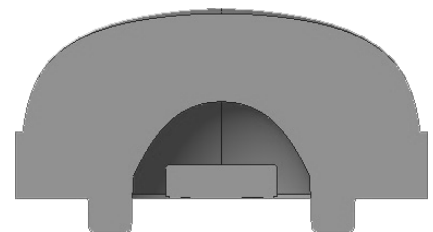

LL01CR-AU45135L46 Package Specifications

| Item | Quantity | Total | Size(L*W*H) | G.W |
|----------------|-----------------------|----------|-------------|-------|
| Inside the bag | 100 pcs/vacuum-packed | 200 pcs | 20*15 cm | 1.6 g |
| Outer box | 20 plastic bags/box | 4000 pcs | 40*37*21 cm | |

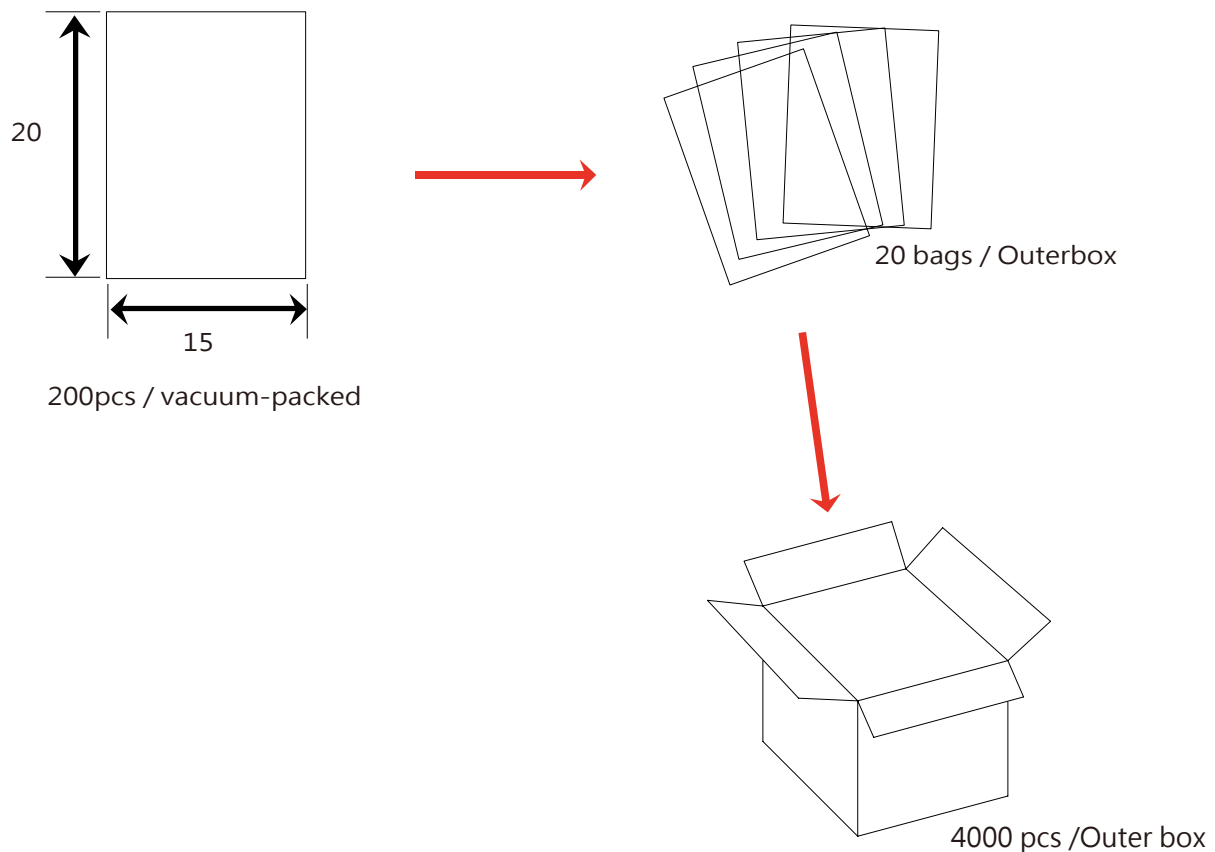

Note: