

M3-310 OEM Media Player

USER GUIDE

Version 1.2

Revision History

Amendment Date	Version
March 2009	V 1.0
April 2009	V 1.1
October 2009	V 1.2

Table of Contents

1	Introduction.....	4
2	System Design	5
	2.1 Familiarization	5
3	Connection Overview	7
	3.1 Prepare for connection.....	7
	3.2 Basic connection for M3-310.....	7
4	System Notes	9
5	Connectors, pinouts & jumpers.....	12
	5.1 Jumpers setting	13
	5.2 Pin Assignment.....	15
6	LCD Display Setup	21
	6.1 Use of OSD switch mount.....	21
	6.2 OSD Functions for LCD display.....	22
7	Operating Setup	24
	7.1 OSD Configuration	24
	7.2 Start up	25
	7.2.1 Start track mode.....	25
	7.2.2 Sleep mode.....	25
	7.3 Loop Playback	26
8	Playback Operation	27
	8.1 Playback modes.....	27
	8.1.1 Playlist mode.....	27
	8.1.2 Simple play mode	27
	8.2 Operating functions.....	28
	8.3 Formatting Compact flash card	29
	8.4 Exporting Project and Playlist	30
	8.5 USB update.....	32
9	Dimension	33
10	Specification	34

1 Introduction

The M3-310 is an embedded video media player OEM board with a built in LCD interface. The board is ideally suited for fanless solid-state media player and LCD display products for market applications such as digital signage, retail promotion systems and information displays in places such as museums.

This brief guide explains how to set up the M3-310 media player board. It is intended for system integrators looking to build a media player with an integrated LCD display.

A few of the key features:

- Suitable for fanless system designs with CF card storage
- Supports a wide range of LCD panels
- Media support includes:
 - MPEG-1, MPEG-2, MPEG-4 (DivX)
 - MPEG still
 - JPEG
- Dedicated button interface
- External communication and control through RS-232 (full protocol set available)
- USB update of media
- Range of outputs including:
 - Direct LCD panel connection
 - Support TFT (active matrix) LCD with LVDS and TTL single pixel interface of the following panel resolutions:
 - 1600x1200
 - 1366x768
 - 1280x1024
 - 1280x768
 - 1024x768
 - 800x600
 - 800x480
 - 640x480

USAGE NOTE

Unless the M3-310 has been customized the media player functions will be the same as used in the Digital View media players:

- ViewStream 300 (VS-300) : A stand-alone media player
- M3-300 : A stand-alone media player (board)

Note: Reference to these models and related documentation should provide a good basis for understanding the operation and capabilities of the M3-310 media player board. For details about custom options please contact Digital View.

2 System Design

IMPORTANT NOTE: Whilst the M3-310 does make it easy to build a media player based system it is intended for use by qualified system builders and integrators; the manufacturer accepts no liability for damage or injury caused by the use of this product. It is the responsibility of the system builder or integrator using the M3-310 and related parts to:

- Ensure that all necessary and appropriate safety measures are taken.
- Obtain relevant regulatory approvals.
- Check power settings to all component parts before connection.

DISCLAIMER: There is no implied or expressed warranty regarding this material.

2.1 Familiarization

The M3-310 media player board has a number of accessories, internal connectors headers, external type connectors and indicator lamps. Before any system design commences it is important to understand the purpose of all these and the system options they enable – please review the board itself together with the notes and relevant tables as detailed throughout this user guide:

M3-310:

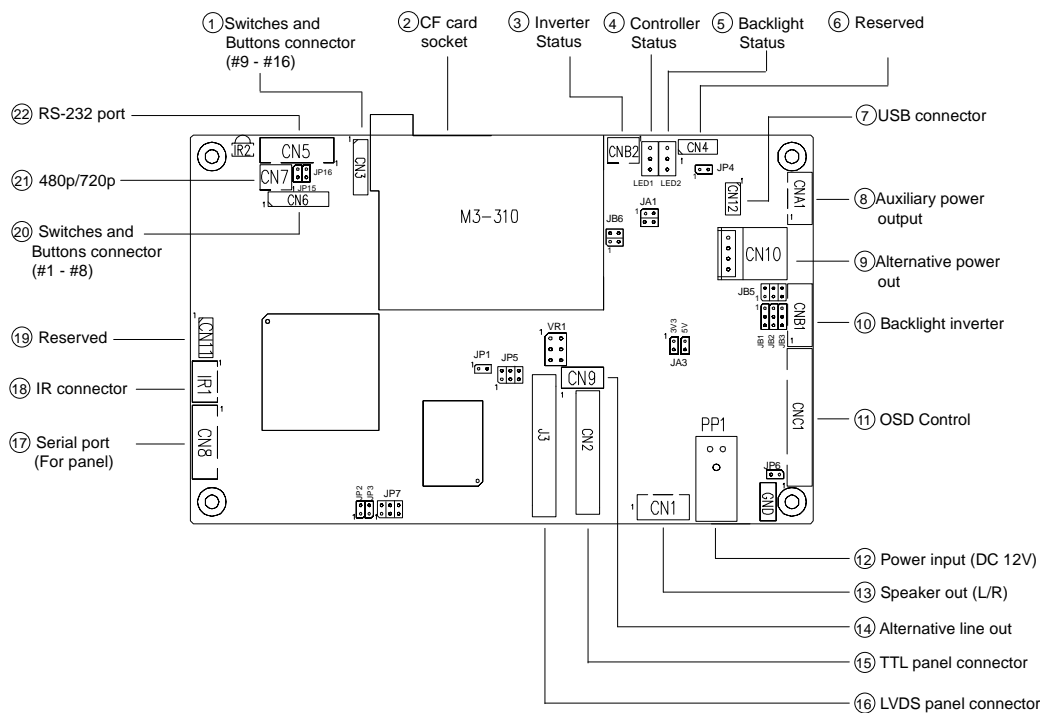

Summary:

1. Switches and buttons (9 – 16 button)	12. Power input (DC +12V)
2. Compact Flash card slot	13. Speaker out (L/R)
3. Inverter status	14. Alternative line out
4. LED1 - Controller status	15. TTL panel connector
5. LED2 - Backlight status	16. LVDS panel connector
6. Reserved	17. Serial port (for panel control)
7. USB connector	18. IR sensor connector
8. Auxiliary power output	19. Reserved
9. Alternative power out	20. Switches and buttons (1 – 8 button)
10. Backlight inverter	21. Output resolution (480/720p)
11. OSD control	22. RS-232 port

For detailed pin-outs on all connectors see the tables in Section 5 below

3 Connection Overview

CAUTION: Never connect or disconnect parts of the system when the system is powered up as this may cause serious damage.

3.1 Prepare for connection

Connection and usage are straightforward. However, during assembly, care needs to be taken regarding the following:

- Ensure parts, especially power and signal cables, match the system. If you are making your own cables & connectors refer carefully to the video monitor specifications and the "Connectors, Pin outs & Jumpers" section in this user guide to ensure the correct pin-to-pin wiring.
- Ensure cables have been correctly connected and that connections are secure.
- Screws and fasteners need to be secure, consider using locking glue if appropriate.
- Switches and jumpers are set correctly.
- The output signal is compatible with display equipment.
- Legal & safety requirements have been met with particular attention to the likely operating environment. Although the M3-310 is designed to be fanless in normal conditions some installations and environments may require additional cooling.

3.2 Basic connection for M3-310

The following summarizes a simple connection:

- Connect the inverter (if it is not built-in the panel) to the CCFT lead connector(s) on the panel.
- Plug the inverter cable to CNB1 and CNA1.(if necessary) on the M3-310. Plug another end to the connector on the inverter.

Note: Different inverter models require different cables and different pin assignment. Make sure correct cable pin out to match inverter. Using wrong cable pin out may damage the inverter.

- Plug the panel signal cable direct to CN2 (if TTL panel is used) or J3 (if LVDS panel is used) on the M3-310. Plug the other end of cables on the LCD panel connector.

- **CAUTION:** Before connecting power ensure all parts are suitably insulated and there is no risk of short circuit or electrocution. Connect the power supply (DC 12V @ 1.2A minimum. - ensure correct polarity) to the M3-310 power input (PP1).
- Plug the OSD switch mount cable (p/n:420680260-3) to CNC1 on the M3-310 and another to the OSD switch mount. (P/N:416100520-3)
- For "Auto play with Power On" , short the pin1-2 on JP6
- Ensure there is a CF card installed with compatible media loaded.
- If the optional buttons are being used connect them to CN6 and CN3

4 System Notes

The following outlines various issues related to the M3-310 and making a complete system:

- **LED1/LED2** - The power/status LED indicator shows the following status of Panel:

Controller LED status (LED1):

Panel State	LED color
No signal & backlight off	RED
No signal & backlight on	ORANGE
With signal & backlight on	GREEN

Backlight LED status (LED2):

Panel State	LED color
Backlight fault	RED
Backlight normal	GREEN

NOTE: This status is only available when CNB2 is proper connected and the panel is support the backlight status function.

- **RS-232 port** – This port supports RS-232 communications for control. The baud rate must be set to (9600, n,8,1) and record suffix is set to CR (0DH).
- **USB** – Plug an USB extension cable (P/N:426894600-3). Use a USB flash drive for content update without removing the CF card. The M3-310 will reset the power when a USB flash drive is inserted or removed from the USB connector. (For the details of USB content update, please refer to the Application note.)
- **Audio output** – This provides speaker out and line out connection. Master volume is controlled through OSD with buttons connecting to CN6. For connection, plug a stereo speaker (P/N 230800301) with stereo cable (P/N 426680900-3) to the connector CN1. If for line out connection, connect an audio line out cable (P/N 426450300-3) to CN9.
- **Volume control** – To control the loudness of internal speaker, a 47K Volume Rotary (VR) can be used. Plug the VR extension cable (P/N:426890510-3) on to the jumper VR1.
- **Jumpers & Inverter & Panel voltage** – pay special attention to the settings of JA3, JB2 & JB3. The JB2 & JB3 are used for inverter control (read inverter specification and information on the jumper table to define the correct settings). The JA3 is used for panel voltage input (read panel specification and information on the jumper table to define the correct settings).

- **Power supply** - Plug the DC 12V power (ensure correct + & - orientation) in to the connector PP1. The Digital View mating power cable is (P/N 426013800-3), 160mm. Please read the jumper table in Section 5 to define the correct settings. Otherwise it may break down the panel. **(Note: Maximum current output to panel: 2A)**
- **Power on** - Switch on the M3-310 board and panel by using the OSD switch mount (P/N 416100520-3) or short Pin1-2 at JP6 for "Auto power On".
- **Infra-red (IR)** - Supports IR control with DV remote control handset (P/N:559000104-3). The IR sensor and cable kit (P/N:446010401-3) are required. The IR control functions are shown as below.



- **Buttons and Touch screen (segment type)** – A number of related accessories are available providing enhanced functionality such as user buttons and touch screen.

A) Mechanical buttons

- Standard MV-switchmount (P/N:416101300-3) for 1-8 buttons when connected to the button connector CN6 via the standard switchmount cable (P/N:426451100-3).

- Custom made switchmount for 1-16 buttons when connected to the buttons connector CN6 and CN3 via the standard switchmount cable (P/N:426451100-3)

B) Touch screen segments

- The M3-310 when connected with a LCD interface controller can output videos on to LCD screen. Button control can be performed via touch screen for panel sizes of 6.4", 7", 8", 10", 12", 15", 17" and 20"
- There is one type of button pattern layouts on the touch screen available: 8 buttons

(For any special button layout, please contact local sales office.)

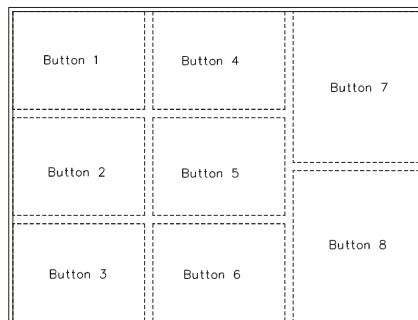
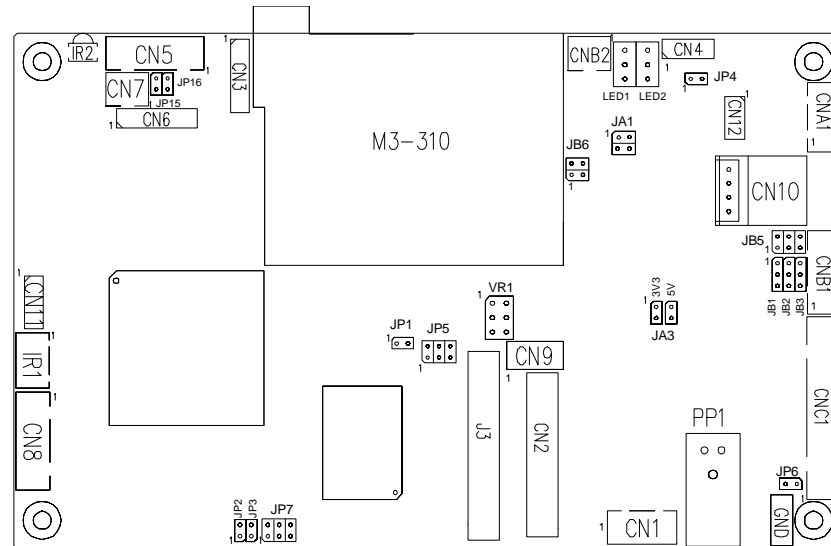

Fig. 1 8-buttons for LCD touch screen

C) Button function settings

- Whether the buttons are of the mechanical type (on the standard switchmount or custom made) or the touch screen segment type, each button function can be programmed with **the DV Studio Software program** to perform a VCD player mode function or specific track select function. **(See DV Studio Software user manual).**
- The DV Studio Software program is available for free download from the Digital View website.
- **Service & Warranty Forfeit:** The warranty will be invalid if rework is performed on the M3-310. The M3-310 is not user serviceable or repairable.

5 Connectors, pinouts & jumpers



The various connectors are:



Ref	Purpose	Description
CN1	Speaker out (L/R) connector	JST B4B-XH-A
CN2	TTL panel signal	Hirose 40-pin, DF20G-40DP-1V
CN3	Switches and buttons connector (#9 - #16)	Hirose 1.25mm, 9-pin, DF13-9P-1.25DSA
CN4	Watchdog programmer connector (Reserved)	Hirose 1.25mm, 6-pin, DF13-6P-1.25DSA
CN5	RS-232 port	JST B6B-XH-A
CN6	Switches and buttons connector (#1 - #8)	Hirose 1.25mm, 9-pin, DF13-9P-1.25DSA
CN7	Resolution selector (640x480/1280x720)	JST B2B-XH-A
CN8	Serial control	JST B6B-XH-A
CN9	Alternative audio output	JST B4B-PH-K
CN10	Alternative power out connector	JS-1116-04WS
CN11	Reserved	Hirose 1.25mm, 6-pin, DF13-6P-1.25DSA
CN12	USB connector	Hirose 1.25mm, 4-pin, DF13-4P-1.25DSA
CNA1	Auxiliary power output	JST B4B-XH-A
CNB1	Backlight inverter	JST B5B-XH-A
CNB2	Backlight status	JST B2B-XH-A
CNC1	OSD controls	JST B12B-XH-A
PP1	Power input	Molex 43650-0200
IR1	IR sensor connector	JST B3B-XH-A
VR1	External volume control	3x2 header (2.54mm pitch)
J3	LVDS panel signal	Hirose DF13-40DP-1.25DSA
J6	CF card connector	CF-CARD, 25x2Ppin 3M CF-II socket
J7	USB connector	JST B4B-ZR

5.1 Jumpers setting

Ref	Purpose	Note
JA1	For internal testing	1-3 & 2-4 closed, factory set, do not remove
JA3	Panel power voltage select	See panel voltage setting table 1 CAUTION: Incorrect setting will cause panel damage
JB1	Backlight brightness voltage range	1-2 closed = 3.3V max* 2-3 closed = 5V max
JB2	Backlight inverter on/off control – signal level	2-3 = On/Off control signal 'High' = +5V* 1-2 = On/Off control signal 'High' = +3.3V Open = On/Off control signal 'High' = Open collector CAUTION: Incorrect setting can damage inverter.
JB3	Backlight inverter on/off control – polarity	1-2 = control signal 'high' = CCFT ON* 2-3 = control signal 'low' = CCFT ON
JB5	Backlight control type selection	1-2 =VR/Digital switch mount control 3-4 =Reserved 5-6 =Reserved
JB6	Backlight status	1-2, 3-4 closed = Backlight status Low – Normal 1-3, 2-4 closed = Backlight status High – Normal Open = Backlight status not used
JP1	Reserved	Reserved for internal programming use (Always 1-2 closed)
JP2	Panel selection	See table 3 below
JP3	Panel selection	See table 3 below
JP4	Detect the watchdog pulse	1-2 closed =Off the detection* 1-2 opened=On the detection
JP5	Panel selection	See table 2 below
JP6	Input power control	Short = External switch control Open = Switch mount control
JP7	Panel selection	See table 4 below

* Factory default

Table 1: Panel voltage setting

Input voltage via PP1	Panel Voltage	JA3	Jumper on board
12VDC	3.3V	3V3 closed	
	5V	5V closed	

CAUTION: Incorrect setting can damage the panel & controller

Table 2: Panel selection (JP5) – Panel model

JP5			Description	Panel resolution
1-2	3-4	5-6		
For WXGA panel				
Opened	Opened	Opened	Samsung LTA260W2-L01 ⁽¹⁾	1366x768
Opened	Opened	Closed	AU M220EW01 ⁽¹⁾	1680x1050
Opened	Closed	Opened	NEC NL12880BC20-02D ⁽¹⁾	1280x800
Opened	Closed	Closed	Sharp LQ315T3LZ24 ⁽²⁾	1366x768
			AU Optronics M156XW01 V0 ⁽²⁾	1366x768
For XGA panel				
Opened	Opened	Opened	AU M150XN07 ⁽¹⁾	1024x768
Opened	Opened	Closed	LG LM150X08-A4 ⁽¹⁾	1024x768
Opened	Closed	Opened	Sharp LQ150X1LGB1 ⁽²⁾	1024x768
			Sharp LQ150X1LGN2A ⁽²⁾	1024x768
For VGA panel				
Opened	Opened	Opened	LG LP104V2 ⁽¹⁾	640x480
			Data Image FG080012DNCWAG0Z ⁽¹⁾	640x480
Opened	Opened	Closed	AU Optronics G104VN01 ⁽¹⁾	640x480
Opened	Closed	Opened	Sharp LQ10D421 ⁽¹⁾	640x480
Others				
Opened	Opened	Closed	PrimeView PD104SL5 ⁽²⁾	800x600
			AU Optronics A201SN01 ⁽²⁾	800x600
Opened	Closed	Opened	Samsung LTM170ET01 ⁽³⁾	1280x1024
Opened	Closed	Closed	Samsung LTM190M2-L31 ⁽³⁾	1440x900
Closed	Opened	Opened	CPT CLAA102NA0ACW ⁽⁴⁾	1024x600

Note: In addition to the above panel support lists, we are on going to support various panel models for M3-310. Please contact Digital View offices for supporting your panel that are not listed.

Panel selection (JP2 & JP3) - Resolution

JP2	JP3	Description
Closed	Opened	WXGA
Opened	Closed	XGA
Opened	Opened	VGA
Closed	Closed	Others

Table 4: Panel selection (JP7) – Panel timing:

JA7	Function	Description
1-2	Panel pixel format	Closed : Single Pixel Opened : Double Pixel
3-4	LVDS data mapping select	Closed : Mapping A (LVDS panel) Opened : Mapping B (LVDS panel) Please adjust to get the correct picture. See as Appendix II for details of mapping A and B.
5-6	Selection of TTL / LVDS panel connection	Closed : LVDS Opened : TTL

5.2 Pin Assignment

CN1 – Speaker out (Left / Right)

PIN	SYMBOL	DESCRIPTION
1	GND	Ground
2	L	Left speaker out
3	GND	Ground
4	R	Right speaker out

CN2 – Panel connector (TTL)

PIN	SYMBOL	DESCRIPTION
1	GND	Ground
2	GND	Ground
3	NC	No connection
4	NC	No connection
5	RA0	Data bit R0
6	RA1	Data bit R1
7	RA2	Data bit R2
8	RA3	Data bit R3
9	RA4	Data bit R4
10	RA5	Data bit R5
11	RA6	Data bit R6
12	RA7	Data bit R7
13	GND	Ground
14	GND	Ground
15	NC	No connection
16	NC	No connection
17	GA0	Data bit G0
18	GA1	Data bit G1
19	GA2	Data bit G2
20	GA3	Data bit G3
21	GA4	Data bit G4
22	GA5	Data bit G5
23	GA6	Data bit G6
24	GA7	Data bit G7
25	GND	Ground
26	GND	Ground
27	NC	No connection
28	NC	No connection
29	BA0	Data bit B0
30	BA1	Data bit B1
31	BA2	Data bit B2
32	BA3	Data bit B3
33	BA4	Data bit B4
34	BA5	Data bit B5
35	BA6	Data bit B6
36	BA7	Data bit B7
37	GND	Ground
38	GND	Ground
39	VS	Vertical sync
40	CLK	Dot clock
41	HS	Horizontal sync
42	DE	Display enable
43	PWR	Power down control signal (5v TTL)
44	VLCD	Panel power supply (3,3V/5V) (selected by JA3)

45	VLCD	Panel power supply (3,3V/5V) (selected by JA3)
46	VLCD	Panel power supply (3,3V/5V) (selected by JA3)
47	NC	No connection
48	NC	No connection
49	NC	No connection
50	NC	No connection

CN3 – Switches and buttons (#9 - #16)

PIN	SYMBOL	DESCRIPTION
1	SW9	Button 9
2	SW10	Button 10
3	SW11	Button 11
4	SW12	Button 12
5	SW13	Button 13
6	SW14	Button 14
7	SW15	Button 15
8	SW16	Button 16
9	GND	Ground

CN4 – Watchdog programmer connector

CN5 – RS-232 port

PIN	SYMBOL	DESCRIPTION
1	NC	No connection
2	NC	No connection
3	5V	+5V
4	Tx	Tx Data
5	GND	GND
6	Rx	Rx Data

CN6 – Switches and buttons (#1 - #8)

PIN	SYMBOL	DESCRIPTION
1	SW1	Button 1
2	SW2	Button 2
3	SW3	Button 3
4	SW4	Button 4
5	SW5	Button 5
6	SW6	Button 6
7	SW7	Button 7
8	SW8	Button 8
9	GND	Ground

CN7 – Resolution selector

PIN	SYMBOL	DESCRIPTION
1	SYSTEM	1-2 close: 1280x720 1-2 open: 640x480
2	GND	Ground

CN8 – Serial control (for Panel)

PIN	SYMBOL	DESCRIPTION
1	SDATA	Reserved
2	SCLK	Reserved
3	Vcc	+5V
4	TxD	Tx Data
5	GND	GND
6	RxD	Rx Data

CN9 - Alternative speaker output

PIN	SYMBOL	DESCRIPTION
1	GND	Ground
2	AUDIO_L	Audio left channel output
3	GND	Ground
4	AUDIO_R	Audio right channel output

CN10 - Alternative power out

PIN	SYMBOL	DESCRIPTION
1	VCC	+5V out
2	GND	Ground
3	GND	Ground
4	+12V	+12V out

CN11 – Reserved

CNA1 - Alternative power output

PIN	SYMBOL	DESCRIPTION
1	AUX POWER	+12V DC
2	GND	Ground
3	GND	Ground
4	AUX 5V	+5V DC

CNB1 - Backlight inverter

PIN	SYMBOL	DESCRIPTION
1	GND	Ground
2	VBKL	Backlight power supply, +12VDC
3	BLCTRL	Backlight On/Off control signal
4	BVR_WIP	Backlight brightness VR pin WIP
5	BVR_A	Backlight brightness VR pin A

CNC1 - Function control switch

PIN	SYMBOL	DESCRIPTION
1	PSWIN	Power button A

2	SW_ON	Power button B
3	BVR_A	Backlight Brightness VR pin A
4	BVR_WIP	Backlight Brightness R pin WIP
5	BVR_B	Backlight Brightness VR pin B (470 ohm resistor to +5V Vcc)
6	GND	Ground
7	MENU	OSD menu
8	-/LEFT	OSD -/Left
9	+/RIGHT	OSD +/Right
10	SEL_DN	OSD Select down
11	SEL_UP	OSD Select up
12	NC	No connection

LED1 - Controller status LED connector

PIN	DESCRIPTION
1	Green LED pin (anode)
2	LED pin common (cathode)
3	Red LED pin (anode)

LED2 - Backlight status LED connector

PIN	DESCRIPTION
1	Green LED pin (anode)
2	LED pin common (cathode)
3	Red LED pin (anode)

IR1 - IR connector

PIN	SYMBOL	DESCRIPTION
1	GND	Ground
2	STDBY_VCC	Stand by voltage
3	IR_DATA	IR data

J3 - Panel connector (LVDS)

PIN	SYMBOL	DESCRIPTION
1	TXA0+	Positive differential LVDS data bit A0
2	TXA0-	Negative differential LVDS data bit A0
3	TXA1+	Positive differential LVDS data bit A1
4	TXA1-	Negative differential LVDS data bit A1
5	NC	No connection
6	NC	No connection
7	TXA2+	Positive differential LVDS data bit A2
8	TXA2-	Negative differential LVDS data bit A2
9	TXA3+	Positive differential LVDS data bit A3
10	TXA3-	Negative differential LVDS data bit A3
11	GND	Ground

12	GND	Ground
13	TXAC+	Positive LVDS clock for A channel
14	TXAC-	Negative LVDS clock for A channel
15	GND	Ground
16	GND	Ground
17	TXB0+	Positive differential LVDS data bit B0
18	TXB0-	Negative differential LVDS data bit B0
19	TXB1+	Positive differential LVDS data bit B1
20	TXB1-	Negative differential LVDS data bit B1
21	NC	No connection
22	NC	No connection
23	TXB2+	Positive differential LVDS data bit B2
24	TXB2-	Negative differential LVDS data bit B2
25	TXB3+	Positive differential LVDS data bit B3
26	TXB3-	Negative differential LVDS data bit B3
27	GND	Ground
28	GND	Ground
29	TXBC+	Positive LVDS clock for B channel
30	TXBC-	Negative LVDS clock for B channel
31	GND	Ground
32	GND	Ground
33	VDD (3,3V/5V)	Panel power supply (3,3V/5V) (selected by JA3)
34	VDD (3,3V/5V)	Panel power supply (3,3V/5V) (selected by JA3)
35	VDD (3,3V/5V)	Panel power supply (3,3V/5V) (selected by JA3)
36	VDD (3,3V/5V)	Panel power supply (3,3V/5V) (selected by JA3)
37	NC	No connection
38	NC	No connection
39	NC	No connection
40	NC	No connection

J6 – Compact Flash card connector

PIN	SYMBOL	DESCRIPTION
1	GND	Ground
2	D3	Data bit 3
3	D4	Data bit 4
4	D5	Data bit 5
5	D6	Data bit 6
6	D7	Data bit 7
7	/CE1	Card enable 1
8	GND	Ground
9	GND	Ground
10	GND	Ground
11	GND	Ground
12	GND	Ground
13	VCC	+5V

14	GND	Ground
15	GND	Ground
16	GND	Ground
17	GND	Ground
18	A2	Address bit 2
19	A1	Address bit 1
20	A0	Address bit 0
21	D0	Data bit B3
22	D1	Data bit B4
23	D2	Data bit B5
24	IOCS16	IOCS16
25	/CD2	Card detect pin 2
26	/CD1	Card detect pin 1
27	D11	No connection
28	D12	No connection
29	D13	No connection
30	D14	No connection
31	D15	No connection
32	/CE2	Card enable 2
33	GND	Ground
34	/RD	Memory read strobe
35	/WR	Memory write strobe
36	/WE	No connection
37	IRQ	Interrupt request
38	VCC	+5V
39	/CSEL	Chip SEL
40	NC	No connection
41	RESET	System reset
42	IORDY	IO Ready
43	NC	No connection
44	NC	No connection
45	/DASP	DASP
46	/PDIAG	PDIAG
47	D8	No connection
48	D9	No connection
49	D10	No connection
50	GND	Ground

J7 - USB connector

PIN	SYMBOL	DESCRIPTION
1	UVCC	USB - VCC
2	D-	-VE USB Data
3	D+	+VE USB Data
4	GND	Ground

J8 - M3-310 debugger

PP1 - Main power input

PIN	SYMBOL	DESCRIPTION
1	+12_CENTER	+12V DC in center pin
2	GND	Ground

VR1 - External volume control

PIN	DESCRIPTION
1-3, 2-4	Close (Factory default) Open (for connection with 47K VR ext. cable (p/n:426890500-3))

6 LCD Display Setup

6.1 Use of OSD switch mount

By way of explanation the following refers to a set of sample buttons that may be obtained as an option. In addition to power on/off and connection for backlight brightness the controller provides an On Screen Display of certain functions which are controlled by 5 momentary type buttons (analog VR type) or 8 momentary type buttons (digital type):

Controls	Analog VR type	Digital type
On/Off – turns controller board power on	VR toggle switch	On/Off button
Brightness – controls backlight brightness	Rotary VR	Brightness +/- buttons
Menu – turns OSD menu On or Off (it will auto time off) (Function with signal input only)	Menu button	Menu button
Select – Select function / Confirm (Works under OSD menu on state)	SEL DN	SEL DN
Move up to select individual RGB color level OSD page (Works under OSD menu on state)	SEL UP	SEL UP
+ – increase the setting / moves the selector to the next function (Works under OSD menu on state)	+	+
- - decrease the setting / moves the selector to the previous function (Works under OSD menu on state)	-	-
Load factory default	Press and hold SEL DN button to power on the controller	Press and hold SEL DN button to power on the controller
Lock OSD menu (Function with signal input only)	Press and hold MENU button for 15 seconds to enable / disable lock of the OSD menu	Press and hold MENU button for 15 seconds to enable / disable lock of the OSD menu
Switch to next input source (Works under OSD menu off state)	+	+

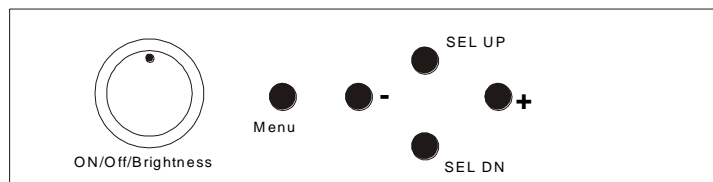



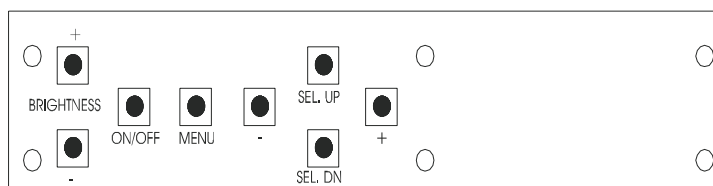







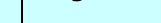

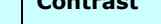





































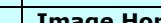

Analog VR type



Digital type

6.2 OSD Functions for LCD display

 Brightness and Contrast			
	Brightness	Increase/decrease brightness level. Press - or + (-  +) Total : 256	
	Contrast	Increase/decrease panel contrast level. Press - or + (-  +) Total : 192	
	Exit	Exit the OSD menu and save the settings	
 Color			
	Auto RGB Calibration#	<input checked="" type="checkbox"/> Yes <input type="checkbox"/> No (See appendix IV)	
	Color Temperature ▶	(Adjust the warmth of the image displayed. The higher temperature the	
		Adjust red color level Press - or + (-  +) Total :128 steps Adjust green color level Press - or + (-  +) Total : 128 steps Adjust blue color level Press - or + (-  +) Total : 128 steps	
		4200K	Set the color temperature to 4200K
		5000K	Set the color temperature to 5000K
		6500K	Set the color temperature to 6500K
		7500K	Set the color temperature to 7500K
		9300K	Set the color temperature to 9300K
	Gamma adjustment ▶	Adjust Gamma settings (0.4 / 0.6 / 1.0 / 1.6 / 2.2)	
		0.4	Select Gamma to 0.4
		0.6	Select Gamma to 0.6
		1.0	Select Gamma to 1.0
		1.6	Select Gamma to 1.6
		2.2	Select Gamma to 2.2
	Exit	Exit the OSD menu and save the settings	
 Position			
	Autosetup	Auto adjust the positions, phase, frequency <input checked="" type="checkbox"/> Yes <input type="checkbox"/> No	
	Frequency	Adjust the image horizontal size	
	Phase	Fine tune the data sampling position (adjust image quality)	
	Image Horizontal Position	Use +/- to move the image horizontally Press - or + (-  +)	
	Image Vertical Position	Use +/- to move the image vertically Press - or + (-  +)	

	Exit	Exit the OSD menu
	Utilities	
	OSD setting ▶	
		OSD Timeout : 0 / 10 / 20 / 30 / 40 / 50 / 60 seconds (Always on when set to 0) Press - or + (- <input type="text"/> +)
		OSD menu horizontal position Press - or + (- <input type="text"/> +)
		OSD menu vertical position Press - or + (- <input type="text"/> +)
	Load Factory Default	Initialize the setting stored in non-volatile memory
	Sharpness	Adjust sharpness level Press - or + (- <input type="text"/> +) Total : 49
	Exit	Exit the OSD menu
	Exit the OSD menu	

Items marked ▶ have sub menus.

Exit the OSD menu to save the setting chosen

7 Operating Setup

Ensure the M3-310 system is ready for use in accordance with preceding sections. With the player system ready for use the following section outlines various configuration settings.

7.1 OSD Configuration

In OSD configuration mode, you may need external buttons, 8-segmented touch screen or IR remote handset to operate.

Use with external button or 8-segmented touch screen

- To enter OSD configuration mode, holding button 8 and power on. The OSD menu screen will be shown as follow:

VOLUME	08	V1.19.00								
Y	M	D	H	M	S					
2009	.	09	.	14	MON	21	:	00	:	12
ID NO:	0000									
DATA LOGGING:	OFF									
OSD:	ON									
JPEG TRANS TYPE:	OFF									
SAVE AND EXIT										

- Press button 8 to select option.
- Press button 7 or button 6 for change value.
- Press button 7 or button 6 to confirm "SAVE AND EXIT".

Use with IR remote handset

- To enter OSD configuration mode, holding "Display" key and power on the M3-300 unit. The OSD menu screen will be shown as follow:

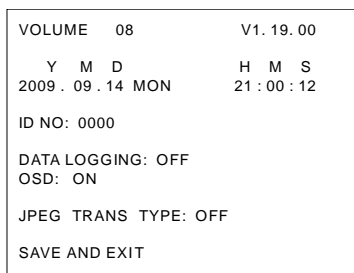

- Press "Display" key to select option.
- Press "+" or "-" key to change value.
- Press "+" or "-" key to confirm "SAVE AND EXIT".

7.2 Start up

Two start-up modes (Start track mode and Sleep mode) can be selected when exporting a playlist to CF Card using DV Studio Plus software.

7.2.1 Start track mode

If start track mode is selected in playlist, the pre-defined started track will be played first after boot-up. For example, if track #5 is defined as the start track, then the M3-310 will play track #5 after start up. (The default start track is the first track in playlist)

Step by step:

- Plug in the external power supply
- Insert Compact Flash Card containing DV Studio Software exported ".pl / .prj" and other media files. (e.g. .mpg, .mp3, .jpg)
- Switch the power 'on/off' switch to 'on'.
- The track #5 (started track) will be played first.
- Once the track #5 is finished, the first track in playlist will be followed and played.

7.2.2 Sleep mode

If sleep mode is selected in a playlist, a blank screen will be shown at the beginning until the pre-defined button has been pressed. For example, if button# 3 is defined in sleep mode, after boot-up the M3-310 will play a blank screen until the button #3 is pressed.

Step by step:

- Plug in the external power supply
- Insert CompactFlash Card containing DV Studio Software exported “.pll / .prj” and other media files. (e.g. .mpg, .mp3, .jpg)
- Switch the power 'on/off' switch to 'on'.
- Press 'button #3'.
- The first track will be played.

Note: Special specific track playback activated by an assigned button can also be performed in sleep mode - contact Digital View for details.

7.3 Loop Playback

The M3-310 will play in auto-loop play mode, so long as none of the function buttons are pressed.

(NOTE: Loop playback is the standard playback setting of the M3-310 but the track playback sequence can be changed as required: contact local sales office.)

8 Playback Operation

8.1 Playback modes

There are two playback modes in M3-310 – “Playlist mode” and “Simple play mode”.

8.1.1 Playlist mode

When operating in playlist mode, both the project file (*.prj) and the playlist file (*.pll) must be present on the Compact Flash card. These are used to control the sequence for all video tracks.

The project and playlist file are created using the Digital View **DV Studio Plus** software which is available for download from the Digital View website. Using this software, you can set simple sequences or complex sequences including “jump track” or “next track” actions. DV Studio can also program buttons with different functions such as “play”, “stop”, “pause”, “mute”, “previous”, “next” and “volume”.

8.1.2 Simple play mode

In simple play mode, the user just copies all video files (.mpg/.avi/.mov) or JPEG files (.jpg) onto the CF card in a folder called Media. The M3-310 will play these files in alphanumeric sequence.

For JPEG files, the play time can be set by the last digit of the filename. (For example: APPLE5.jpg, where “5” means the track will be displayed for 5 seconds.) *Note: Do not use the same filename for both MPEG and JPEG.*

Note:

- (1) Make sure all capital letters in filename defined in playlist are consistent with the filename on the CF card. All filenames should be in 8.3 format (i.e. xxxxxxxx.xxx) and avoid using any illegal characters like “~”, “_”, “-”, etc
- (2) All files (including project file and playlist file) must be placed under a folder named “Media” on Compact Flash card. For example:

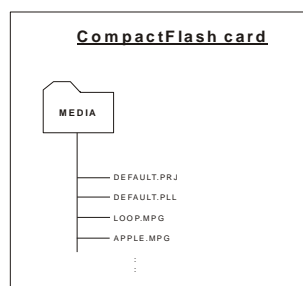

Playlist mode

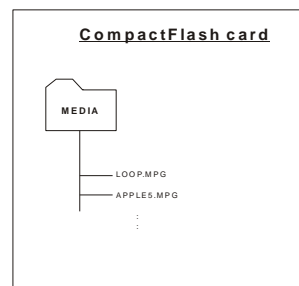

Simple play mode

8.2 Operating functions

The following shows the default button operation in "Simple Play mode". (This requires a button switch-mount or 8-segments touch screen connected.)

PLAY (Button 1)	<ul style="list-style-type: none"> • Resumes playback of videos from track 1 after STOP has been pressed. • Resumes playback of the track from the point that it has been set to PAUSE. • Playback is reset back to the beginning of the specific track which is being played at the time the PLAY button is pressed.
STOP (Button 2)	<ul style="list-style-type: none"> • When STOP is pressed the video stops playing and a blank screen is displayed.
PAUSE (Button 3)	<ul style="list-style-type: none"> • When PAUSE is pressed playback will pause and the current image will remain screen. • Press Pause again or PLAY to resume normal playback from the position where it was paused.
REPEAT (Button 4)	<ul style="list-style-type: none"> • When REPEAT is pressed the current track loop back on itself continuously. • To disable the repeat mode press REPEAT, PLAY, PREVIOUS TRACK or NEXT TRACK . When the track plays to the end it will playback the next track (and etc.) as normal.
NEXT TRACK (Button 5)	<ul style="list-style-type: none"> • The NEXT TRACK function can be activated only when a track is already playing. When NEXT TRACK is pressed the current video stops playing and jumps directly to the start of the next track.
VOLUME - (Button 6)	<ul style="list-style-type: none"> • Decreases audio output volume setting.
VOLUME + (Button 7)	<ul style="list-style-type: none"> • Increases audio output volume setting.
MUTE (Button 8)	<ul style="list-style-type: none"> • When MUTE is pressed, all the tracks will have no sound. • Press MUTE again to resume the normal sound in all tracks.

Note : The buttons can be re-defined by DV Studio Plus* software if operating in playlist mode.

*DV Studio Plus software can be found and downloaded from www.digitalview.com

8.3 Formatting Compact flash card

It is recommended that CF cards are re-formatted with FAT32 again before use.

Formatting procedure for Windows:

- Double click the **My Computer** icon on your Windows desktop.
- Right-click the drive name of card reader.
- Click **Format**. The format dialog box appears.
- Click **Start**.

Notes:

 CF cards should be formatted using FAT32 before first use.

 All media files on the CF must be in a folder name "media".

 Filenames must be alpha-numeric characters only, not '~', '_', '-', '!', '@', '^', etc.

8.4 Exporting Project and Playlist

Use DV Studio Plus* software to export your project file (.prj) and playlist file (.pll). Make sure the CF card is formatted with FAT32 and the CF card reader is connected and the driver is well installed. The CF card reader is auto-detected as the 'Removable Disk'

*DV Studio Plus software can be found and downloaded from www.digitalview.com

- Open **DV Studio Plus** software.
- Add a new playlist.

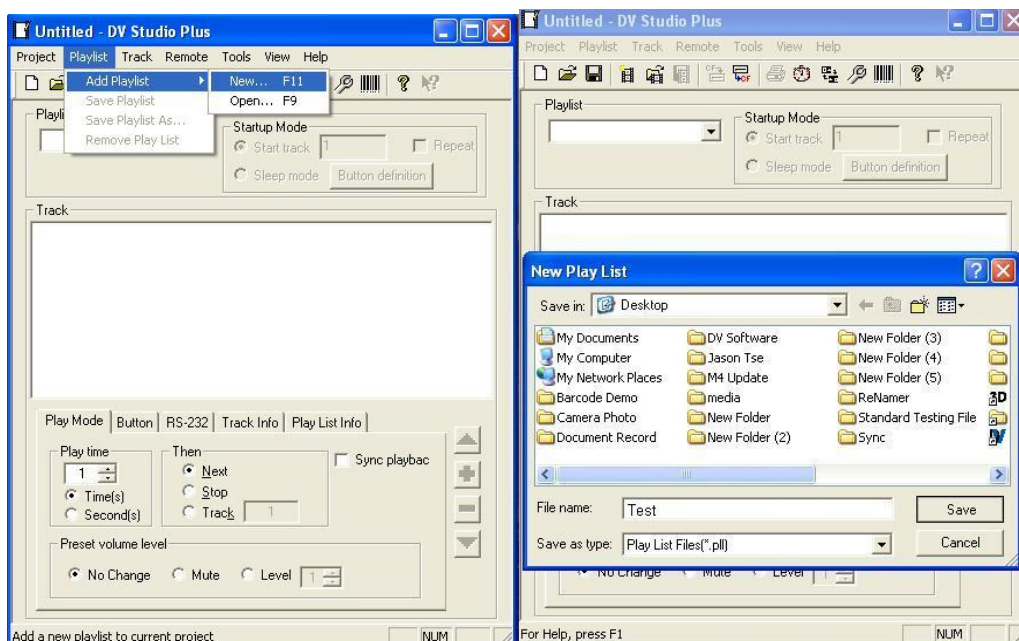

- Insert a media file to the playlist.

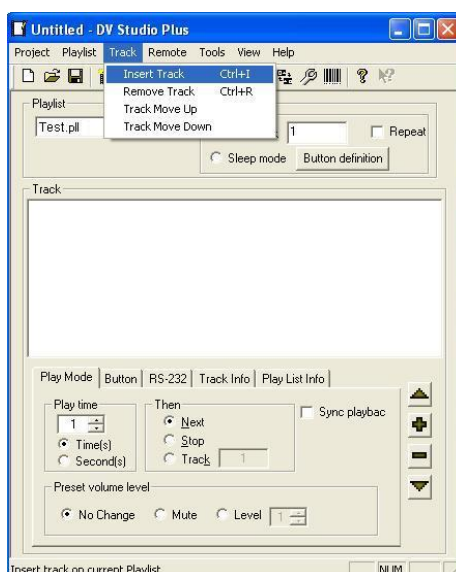

- Set the play mode and button.

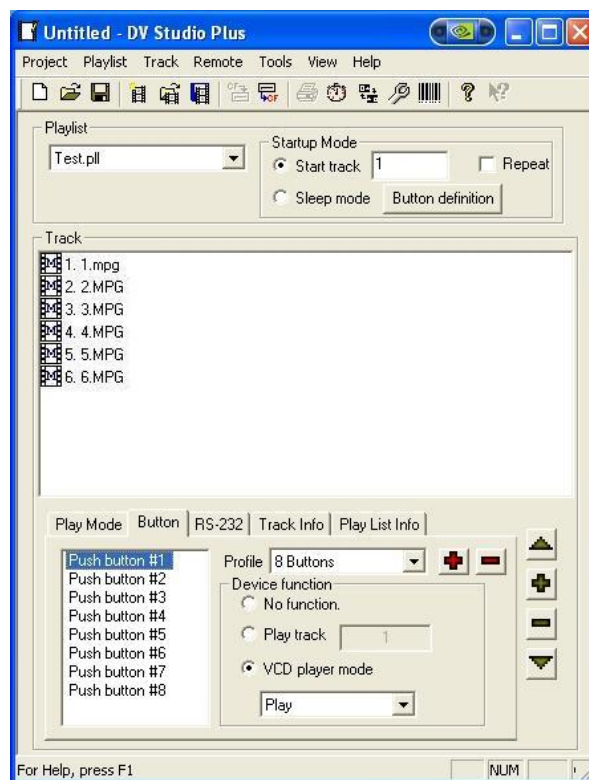
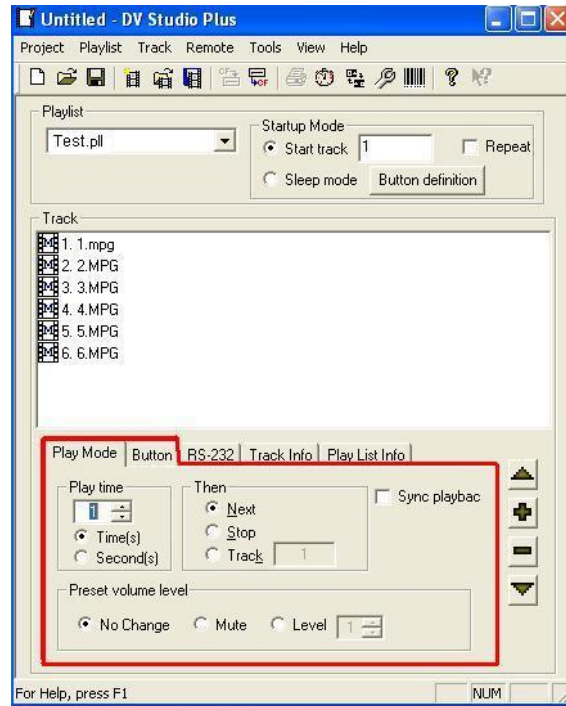

- In the **Project** pull down menu, select **Export** and click **Local Drives**



- Click  to select destination drive (i.e. Removable Disk).
- Enter the file path including a **Media** folder to export on CF card (e.g. E:\MEDIA), then click **OK**



- Click **Start** to export.

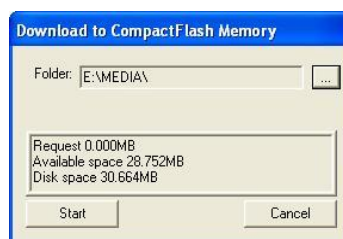

8.5 USB update

The M3-310 USB port provides the ability to connect a USB memory stick directly and to read and write data to and from the Compact Flash card using the automatic USB update capability. *(Please refer to Application Note* for details)*

*Application Notes can be found and downloaded from www.digitalview.com

9 Dimension

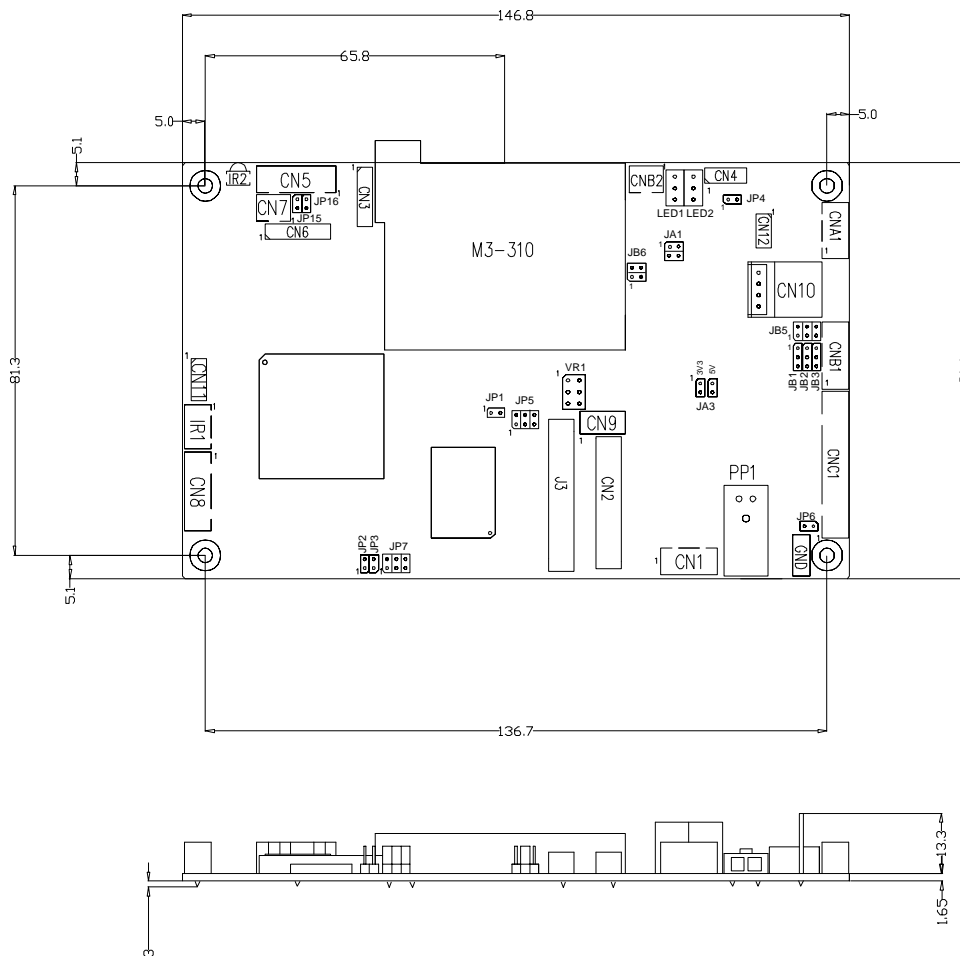

The maximum thickness of the board is 38mm without add-on board (measured from bottom of PCB to top of components, including any underside components & leads). We recommend clearances of:

- 5mm from bottom of PCB - if mounting on a metal plate we also recommend a layer of suitable insulation material is added to the mounting plate surface.
- 10mm above the components
- 3~5mm around the edges

Any of the holes shown above can be used for mounting the PCB, they are 3.2mm in diameter.

CAUTION: Ensure adequate insulation is provided for all areas of the PCB with special attention to high voltage parts. (e.g. the inverter)

10 Specification

Playable format	MPEG-1 (.mpg) Encoding bit rate: 1.15Mbit/s MPEG-2 (.mpg) Encoding bit rate: 5Mbit/s MPEG-4 DivX (.avi) Encoding bit rate: 2Mbit/s JPEG (.jpg)
Storage media	Compact Flash memory card Recommended max. capacity: 16GB
Panel output resolution	1280x720 or 640x480
Audio line out	3.2V p-p max. 5kohm
Speaker out	1.5W @4ohm stereo
Audio volume	Controlled through OSD with switches attached or IR
Playback functions	Play / Stop / Pause / Repeat / Previous track / Next track / Volume / Mute Loop playback / Sequence play / Startup mode / Sleep mode
Touch screen functions	Support Analog touch glass (4-wires) and ITO (8 or 16 segment type) touch glass
External I/O ports	RS-232 (9600, N-8-1) USB (content upload) Infra-red (use with DV IR handset, P/N:559000104-3) Serial port (Panel status monitoring and control, 2400, n-8-1)
Watchdog	Support system reset
Real time clock	Battery-backup RTC
Aux. power out	+5V DC (fuse protection) +12V DC (fuse protection)
Power requirement	Regulated DC 12V input (2.5mm center positive)
Power consumption	560mA @ 12V (no panel connection)
Environmental	Operating temperature : 0°C to 50°C Relative humidity : 5%-95% relative humidity (Non-condensing)
Dimensions	147 (W) x 92 (D) x 18 (H) mm
Weight (net)	135g

WARRANTY

The products are warranted against defects in workmanship and material for a period of three (3) year from the date of purchase provided no modifications are made to it and it is operated under normal conditions and in compliance with the instruction manual.

The warranty does not apply to:

- Product that has been installed incorrectly, this specifically includes but is not limited to cases where electrical short circuit is caused.
- Product that has been altered or repaired except by the manufacturer (or with the manufacturer's consent).
- Product that has subjected to misuse, accidents, abuse, negligence or unusual stress whether physical or electrical.
- Ordinary wear and tear.

Except for the above express warranties, the manufacturer disclaims all warranties on products furnished hereunder, including all implied warranties of merchantability and fitness for a particular application or purpose. The stated express warranties are in lieu of all obligations or liabilities on the part of the manufacturer for damages, including but not limited to special, indirect consequential damages arising out of or in connection with the use of or performance of the products.

CAUTION

Whilst care has been taken to provide as much detail as possible for use of this product it cannot be relied upon as an exhaustive source of information. This product is for use by suitably qualified persons who understand the nature of the work they are doing and are able to take suitable precautions and design and produce a product that is safe and meets regulatory requirements.

SAFETY INSTRUCTION

Do not use this product near water, for example, near a bathtub, wash bowl, kitchen sink, laundry tub, in a wet basement or near a swimming pool.

LIMITATION OF LIABILITY

The manufacturer's liability for damages to customer or others resulting from the use of any product supplied hereunder shall in no event exceed the purchase price of said product.

LICENSING REQUIREMENTS

Depending on the features desired, customer/purchaser may be required to obtain a license with the relevant organizations.

TRADEMARKS

The following are trademarks of Digital View Ltd:
Digital View
M3-310

CONTACT DETAILS

USA: Digital View Inc.
18440 Technology Drive
Building 130
Morgan Hill, CA 95037
Tel: (1) 408-782 7773 **Fax:** (1) 408-782 7883
Sales: ussales@digitalview.com

EUROPE: Digital View Ltd
6 Marylebone Passage
London
W1W 8EX
UK
Tel: (44) (0)20 7631 2150 **Fax:** (44) (0)20 7631 2156
Sales: uksales@digitalview.com

ASIA: Digital View Ltd
16th floor, Millennium City 3
370 Kwun Tong Road
Kwun Tong
Hong Kong
Tel: (852) 2861 3615 **Fax:** (852) 2520 2987
Sales: hksales@digitalview.com