

# BGSA12GN10

Low  $C_{OFF}$  Dual-Pole Single Throw Antenna Tuning Switch

## Data Sheet

Revision 2.1 - 2016-03-08

**Edition 2016-03-08**

**Published by  
Infineon Technologies AG  
81726 Munich, Germany**

**©2012 Infineon Technologies AG  
All Rights Reserved.**

### **Legal Disclaimer**

The information given in this document shall in no event be regarded as a guarantee of conditions or characteristics. With respect to any examples or hints given herein, any typical values stated herein and/or any information regarding the application of the device, Infineon Technologies hereby disclaims any and all warranties and liabilities of any kind, including without limitation, warranties of non-infringement of intellectual property rights of any third party.

### **Information**

For further information on technology, delivery terms and conditions and prices, please contact the nearest Infineon Technologies Office ([www.infineon.com](http://www.infineon.com)).

### **Warnings**

Due to technical requirements, components may contain dangerous substances. For information on the types in question, please contact the nearest Infineon Technologies Office.

Infineon Technologies components may be used in life-support devices or systems only with the express written approval of Infineon Technologies, if a failure of such components can reasonably be expected to cause the failure of that life-support device or system or to affect the safety or effectiveness of that device or system. Life support devices or systems are intended to be implanted in the human body or to support and/or maintain and sustain and/or protect human life. If they fail, it is reasonable to assume that the health of the user or other persons may be endangered.

## Revision History

**Document No.:** BGSA12GN10.pdf

**Revision History:** 2.0

**Previous Version:** 1.2 - 2015-08-04

Page	Subjects (major changes since last revision)
6	added on Table. 3 Absolute Maximum RF Voltage
9	deleted RF Operating Voltage on Table. 7
12	Package Dimensions Drawing figure updated (Figure3)

### Trademarks of Infineon Technologies AG

AURIX™, C166™, CanPAK™, CIPOS™, CIPURSE™, CoolGaN™, CoolMOS™, CoolSET™, CoolSiC™, CORECONTROL™, DAVE™, DI-POL™, EasyPIM™, EconoBRIDGE™, EconoDUAL™, EconoPACK™, EconoPIM™, EiceDRIVER™, eupec™, FCOS™, HITFET™, HybridPACK™, ISOFACE™, I<sup>2</sup>RF™, IsoPACK™, MIPAQ™, ModSTACK™, my-d™, NovalithIC™, OmniTune™, OptiMOS™, ORIGA™, OPTIGA™, PROFET™, PRO-SIL™, PRIMARION™, PrimePACK™, RASIC™, ReverSave™, SatRIC™, SIEGET™, SIPMOS™, SOLID FLASH™, SmartLEWIS™, TEMPFET™, thinQ!™, TriCore™, TRENCHSTOP™.

### Other Trademarks

Advance Design System™ (ADS) of Agilent Technologies, AMBA™, ARM™, MULTI-ICE™, PRIMECELL™, REALVIEW™, THUMB™ of ARM Limited, UK. AUTOSAR™ is licensed by AUTOSAR development partnership. Bluetooth™ of Bluetooth SIG Inc. CAT-iq™ of DECT Forum. COLOSSUS™, FirstGPS™ of Trimble Navigation Ltd. EMV™ of EMVCo, LLC (Visa Holdings Inc.). EPCOS™ of Epcos AG. FLEXGO™ of Microsoft Corporation. FlexRay™ is licensed by FlexRay Consortium. HYPERTERMINAL™ of Hilgraeve Incorporated. IEC™ of Commission Electrotechnique Internationale. IrDA™ of Infrared Data Association Corporation. ISO™ of INTERNATIONAL ORGANIZATION FOR STANDARDIZATION. MATLAB™ of MathWorks, Inc. MAXIM™ of Maxim Integrated Products, Inc. MICROTEC™, NUCLEUS™ of Mentor Graphics Corporation. Mifare™ of NXP. MIPI™ of MIPI Alliance, Inc. MIPS™ of MIPS Technologies, Inc., USA. muRata™ of MURATA MANUFACTURING CO., MICROWAVE OFFICE™ (MWO) of Applied Wave Research Inc., OmniVision™ of OmniVision Technologies, Inc. Openwave™ Openwave Systems Inc. RED HAT™ Red Hat, Inc. RFMD™ RF Micro Devices, Inc. SIRIUS™ of Sirius Satellite Radio Inc. SOLARIS™ of Sun Microsystems, Inc. SPANSION™ of Spansion LLC Ltd. Symbian™ of Symbian Software Limited. TAIYO YUDEN™ of Taiyo Yuden Co. TEAKLITE™ of CEVA, Inc. TEKTRONIX™ of Tektronix Inc. TOKO™ of TOKO KABUSHIKI KAISHA TA. UNIX™ of X/Open Company Limited. VERILOG™, PALLADIUM™ of Cadence Design Systems, Inc. VLYNQ™ of Texas Instruments Incorporated. VXWORKS™, WIND RIVER™ of WIND RIVER SYSTEMS, INC. ZETEX™ of Diodes Zetex Limited.

Last Trademarks Update 2012-12-13

## Contents

<b>1</b>	<b>Features</b>	<b>5</b>
<b>2</b>	<b>Product Description</b>	<b>5</b>
<b>3</b>	<b>Maximum Ratings</b>	<b>6</b>
<b>4</b>	<b>Operation Ranges</b>	<b>7</b>
<b>5</b>	<b>Logic Table</b>	<b>7</b>
<b>6</b>	<b>RF small signal parameter</b>	<b>8</b>
<b>7</b>	<b>RF large signal parameter</b>	<b>9</b>
<b>8</b>	<b>Package Outline and Pin Configuration</b>	<b>11</b>

## List of Figures

1	BGSA12GN10 block diagram	6
2	Pinout (top view)	11
3	Package Dimensions Drawing (TSNP-10-1)	12
4	Package Dimensions Drawing (TSNP-10-2)	12
5	Land pattern and stencil mask (TSNP-10-1/-2)	13
6	Tape drawing (TSNP-10-1)	13
7	Tape drawing (TSNP-10-2)	13
8	Package marking (TSNP-10-1): Date code digits Y and W are found in Table 13/14	14
9	Package marking (TSNP-10-2): Date code digits Y and W are found in Table 13/14	14

## List of Tables

1	Ordering Information	5
2	Maximum Ratings, Table I	6
3	Maximum Ratings, Table II	7
4	Operation Ranges	7
5	Logic Table	7
6	RF small signal specifications	8
7	RF large signal Specifications	9
8	IIP2 conditions table	10
9	IIP3 conditions table	10
10	SV-LTE conditions table	10
11	Pin description	11
12	Mechanical data	11
13	Year date code marking	14
14	Week date code marking	14

# BGSA12GN10 Low $C_{OFF}$ Dual-Pole Single Throw Antenna Tuning Switch

## 1 Features

- high-linearity SPDT for antenna aperture switching applications
- Ultra-Low  $R_{ON}$  of  $1.6 \Omega$  in ON state
- Ultra-Low  $C_{OFF}$  of  $120 fF$  in OFF state
- High max RF voltage handling
- Low harmonic generation
- No power supply blocking required
- Supply voltage: 1.8 to 3.6 V
- Control voltage: 1.35 to 3.3 V (control high)
- Suitable for EDGE / C2K / LTE / WCDMA Applications
- 0.1 to 5.0 GHz coverage
- Small form factor 1.1 mm x 1.5 mm
- 400  $\mu m$  pad pitch
- RoHS and WEEE compliant package

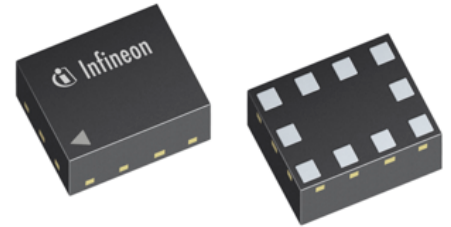

## 2 Product Description

The BGSA12GN10 is a Single Pole Dual Throw (SPDT) RF antenna aperture switch optimized for low  $C_{off}$  enabling applications up to 5.0 GHz. This single supply chip integrates on-chip CMOS logic driven by a simple, single-pin CMOS or TTL compatible control input signal. The 0.1 dB compression point exceeds the switch maximum input power level, resulting in linear performance at all signal levels. Unlike GaAs technology, the 0.1 dB compression point exceeds the switch maximum input power level, resulting in linear performance at all signal levels and external DC blocking capacitors at the RF ports are only required if DC voltage is applied externally. Due to its very high RF voltage ruggedness it is suited for switching any reactive devices such as inductors and capacitors in RF matching circuits without significant losses in quality factors.

**Table 1: Ordering Information**

Type	Package	Marking	Chip
BGSA12GN10	TSNP10-1/-2	A2	BGSA12GN10

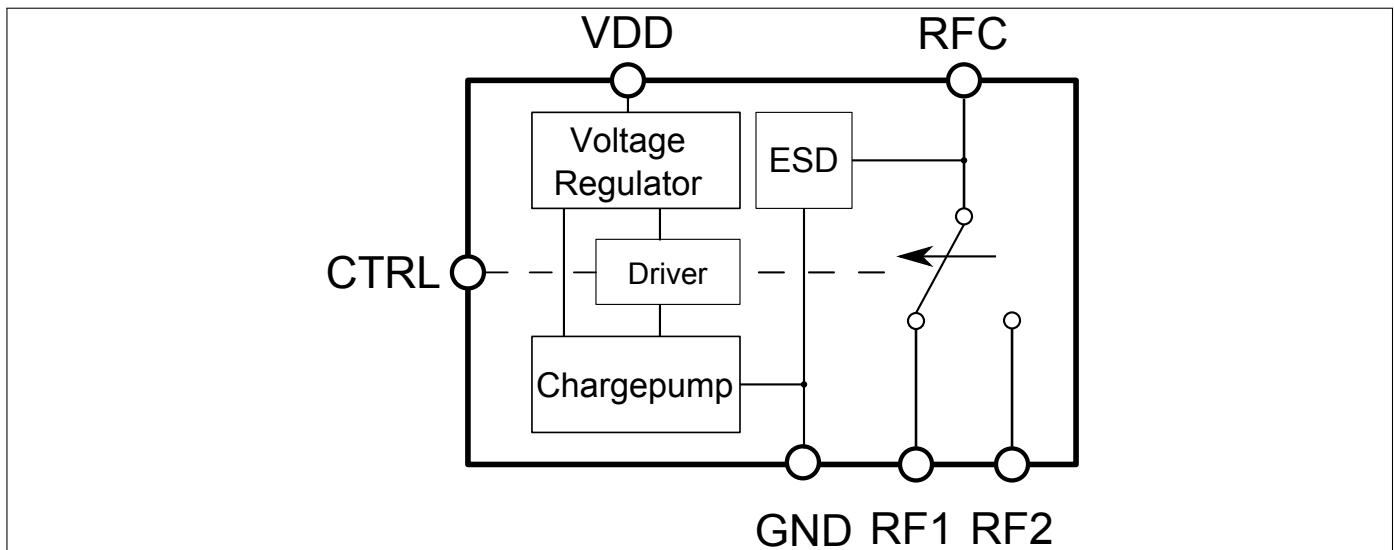

Figure 1: BGSA12GN10 block diagram

### 3 Maximum Ratings

 Table 2: Maximum Ratings, Table I at  $T_A = 25\text{ }^\circ\text{C}$ , unless otherwise specified

Parameter	Symbol	Values			Unit	Note / Test Condition
		Min.	Typ.	Max.		
Frequency Range	$f$	0.1	–	–	GHz	<sup>1)</sup>
Supply voltage <sup>2)</sup>	$V_{DD}$	-0.5	–	3.6	V	–
Storage temperature range	$T_{STG}$	-55	–	150	$^\circ\text{C}$	–
RF input power	$P_{RF\_TRX}$	–	–	39	dBm	25% Duty Cycle
RF voltage <sup>3)</sup>	$V_{RF\_max}$	–	–	48	V	All switch throws operated in isolation mode.
ESD capability, CDM <sup>4)</sup>	$V_{ESD\_CDM}$	-1.5	–	+1.5	kV	
ESD capability, HBM <sup>5)</sup>	$V_{ESD\_HBM}$	-1	–	+1	kV	
ESD capability, system level (RFC port) <sup>6)</sup>	$V_{ESD\_ANT}$	-8	–	+8	kV	RFC vs system GND, with 27 nH shunt inductor
Junction temperature	$T_j$	–	–	125	$^\circ\text{C}$	–

<sup>1)</sup> Switch has no highpass response. There is also a high ohmic DC to the RF path. The DC voltage at RF ports  $V_{RFDC}$  has to be 0V.

<sup>2)</sup> Note: Consider any ripple voltages on top of  $V_{DD}$ . A high RF ripple at the  $V_{DD}$  can exceed the maximum ratings by  $V_{DD} = V_{DC} + V_{Ripple}$ .

<sup>3)</sup> 1000h over 8 years lifetime-short pulse duration

<sup>4)</sup> Field-Induced Charged-Device Model JESD22-C101. Simulates charging/discharging events that occur in production equipment and processes. Potential for CDM ESD events occurs whenever there is metal-to-metal contact in manufacturing.

<sup>5)</sup> Human Body Model ANSI/ESDA/JEDEC JS-001-2012 ( $R = 1.5\text{ k}\Omega$ ,  $C = 100\text{ pF}$ ).

<sup>6)</sup> IEC 61000-4-2 ( $R = 330\ \Omega$ ,  $C = 150\text{ pF}$ ), contact discharge.

**Warning: Stresses above the max. values listed here may cause permanent damage to the device. Exposure to absolute maximum rating conditions for extended periods may affect device reliability. Maximum ratings are absolute ratings; exceeding only one of these values may cause irreversible damage to the integrated circuit.**

**Table 3: Maximum Ratings, Table II at  $T_A = 25\text{ °C}$ , unless otherwise specified**

Parameter	Symbol	Values			Unit	Note / Test Condition
		Min.	Typ.	Max.		
Maximum DC-voltage on RF-Ports and RF-Ground	$V_{RFDC}$	0	–	0	V	No DC voltages allowed on RF-Ports
Control Voltage Levels	$V_{CTRL}$	-0.7	–	3.3	V	–

## 4 Operation Ranges

**Table 4: Operation Ranges**

Parameter	Symbol	Values			Unit	Note / Test Condition
		Min.	Typ.	Max.		
Supply voltage	$V_{DD}$	1.8	2.85	3.6	V	–
Supply current <sup>1)</sup>	$I_{DD}$	–	80	150	$\mu A$	–
Control voltage low	$V_{Ctrl,low}$	0		0.45	V	–
Control voltage high	$V_{Ctrl,high}$	1.2	1.8	2.85	V	$V_{Ctrl,high} \ll V_{DD}$
Control current low	$I_{Ctrl,low}$	-1	0	1	$\mu A$	–
Control current high	$I_{Ctrl,high}$	-1	0	1	$\mu A$	$V_{Ctrl,high} \ll V_{DD}$
Ambient temperature	$T_A$	-30	25	85	$^{\circ}C$	–
RF switching time	$t_{sw}$	2	5	7	$\mu s$	–
Startup time	$t_{sw}$		20	30	$\mu s$	–

<sup>1)</sup>  $T_A = -30\text{ °C} - +85\text{ °C}$ ,  $V_{VDD} = 1.8 - 3.6\text{ V}$ 

## 5 Logic Table

**Table 5: Logic Table**

CTRL	Mode
0	RF1 connected to RFC
1	RF2 connected to RFC



## 6 RF small signal parameter

**Table 6: RF small signal specifications**

Parameter	Symbol	Values			Unit	Note / Test Condition
		Min.	Typ.	Max.		
Frequency range	f	0.1	–	5.0	GHz	–
Switch ON resistance	$R_{ON}$	–	1.6		$\Omega$	RFx to RFC
Switch OFF capacitance	$C_{OFF}$	–	120		fF	RFx to RFC
Parasitic RF shunt capacitance	$C_{SH,PAR}$	–	42		fF	RFx to GND, extracted value for 2 GHz
Switch series inductance	$L_{SER}$	–	0.1		nH	
<b>Insertion Loss</b> <sup>(1,2,3)</sup>						
698 - 960 MHz	IL	–	0.25	0.35	dB	$V_{DD} = 2.3 - 3.6 V, Z_0 = 50 \Omega,$ $T_A = -30 C \dots +85 C$
1710 - 1980 MHz		–	0.32	0.42	dB	
1980 - 2170 MHz		–	0.33	0.42	dB	
2170 - 2690 MHz		–	0.39	0.49	dB	
<b>Return Loss</b> <sup>(1,2,3)</sup>						
All Ports @ 698 - 915 MHz	RL	27.9	32	38	dB	$V_{DD} = 2.3 - 3.6 V, Z_0 = 50 \Omega,$ $T_A = -30 C \dots +85 C$
All Ports @ 1710 - 2170 MHz		22	25	30	dB	
All Ports @ 2170 - 2690 MHz		20	23	27	dB	
<b>Isolation RFx to RFC</b> <sup>(1,2,3)</sup>						
698 - 915 MHz	ISO	28.5	30	30	dB	$V_{DD} = 2.3 - 3.6 V, Z_0 = 50 \Omega,$ $T_A = -30 C \dots +85 C$
1710 - 1980 MHz		22	23	24	dB	
1980 - 2170 MHz		22	22	23	dB	
2170 - 2690 MHz		19	20	21	dB	
<b>Isolation RFx to RFx</b> <sup>(1,2,3)</sup>						
698 - 915 MHz	ISO	29.5	30	31	dB	$V_{DD} = 2.3 - 3.6 V, Z_0 = 50 \Omega,$ $T_A = -30 C \dots +85 C$
1710 - 1980 MHz		22	23	24	dB	
1980 - 2170 MHz		21	22	23	dB	
2170 - 2690 MHz		19	20	21	dB	

<sup>1)</sup> Valid for all RF power levels, no compression behavior

<sup>2)</sup> Network analyser input power:  $P_{IN} = -20 \text{ dBm}$ 
<sup>3)</sup> On application board without any matching components



## 7 RF large signal parameter

**Table 7: RF large signal specifications**  
**Harmonic Generation up to 12.75 GHz**<sup>(1,2,3)</sup>

Parameter	Symbol	Values			Unit	Note / Test Condition
		Min.	Typ.	Max.		
All RF Ports - Second Order Harmonics	$P_{H2}$	–	105	–	dBc	25 dBm, 50Ω, $f_0 = 786$ MHz
All RF Ports - Third Order Harmonics	$P_{H3}$	–	115	–	dBc	25 dBm, 50Ω, $f_0 = 786$ MHz
All RF Ports - Second Order Harmonics	$P_{H2}$	–	93	–	dBc	33 dBm, 50Ω, $f_0 = 824$ MHz
All RF Ports - Third Order Harmonics	$P_{H3}$	–	94	–	dBc	33 dBm, 50Ω, $f_0 = 824$ MHz
All RF Ports	$P_{HX}$	105	–	–	dBc	25 dBm, 50Ω, CW mode
<b>Intermodulation Distortion IMD2</b> <sup>(1,2,3)</sup>						
IIP2, low	IIP2,l	–	110	–	dBm	IIP2 conditions table 8
IIP2, high	IIP2,h	–	120	–	dBm	
<b>Intermodulation Distortion IMD3</b> <sup>(1,2,3)</sup>						
IIP3	IIP3	–	75	–	dBm	IIP3 conditions table 9
<b>SV LTE Intermodulation</b> <sup>(1,2,3)</sup>						
IIP3,SVLTE	IIP3,SV	–	75	–	dBm	SV-LTE conditions table 10

<sup>1)</sup>Terminating Port Impedance:  $Z_0 = 50 \Omega$

<sup>2)</sup>Supply Voltage:  $V_{DD} = 1.8 - 3.6 V$

<sup>3)</sup>On application board without any matching components

**Table 8: IIP2 conditions table**

Band	In-Band Frequency [MHz]	Blocker Frequency 1 [MHz]	Blocker Power 1 [dBm]	Blocker Frequency 2 [MHz]	Blocker Power 2 [dBm]
Band 1 Low	2140	1950	20	190	-15
Band 1 High	2140	1950	20	4090	-15
Band 5 Low	881.5	836.5	20	45	-15
Band 5 High	881.5	836.5	20	1718	-15

**Table 9: IIP3 conditions table**

Band	In-Band Frequency [MHz]	Blocker Frequency 1 [MHz]	Blocker Power 1 [dBm]	Blocker Frequency 2 [MHz]	Blocker Power 2 [dBm]
Band 1	2140	1950	20	1760	-15
Band 5	881.5	836.5	20	791.5	-15

**Table 10: SV-LTE conditions table**

Band	In-Band Frequency [MHz]	Blocker Frequency 1 [MHz]	Blocker Power 1 [dBm]	Blocker Frequency 2 [MHz]	Blocker Power 2 [dBm]
Band 5	872	827	23	872	14
Band 13	747	786	23	747	14
Band 20	878	833	23	2544	14

## 8 Package Outline and Pin Configuration

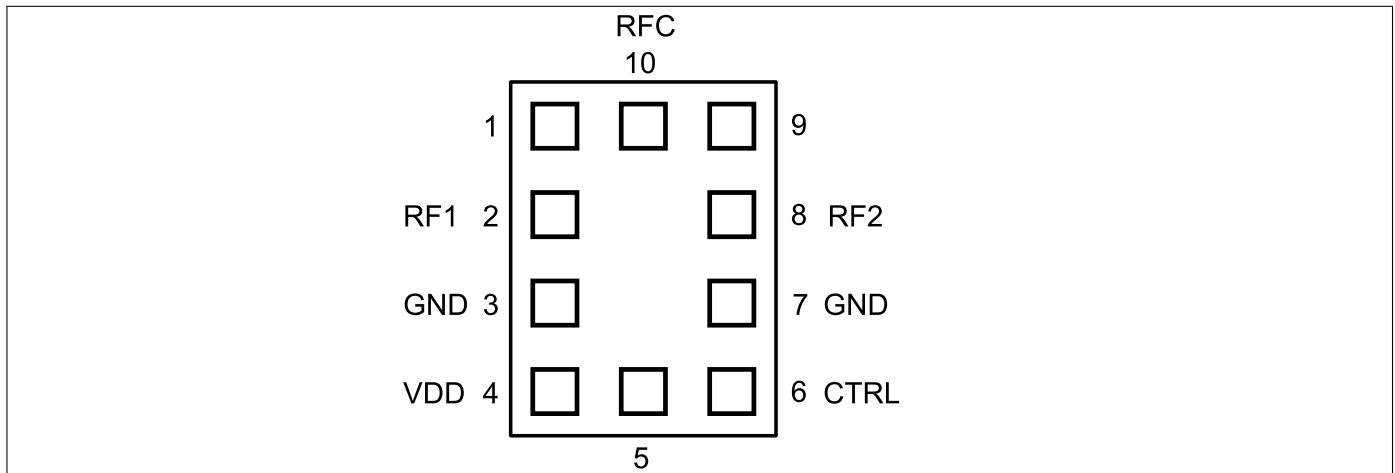

Figure 2: Pinout (top view)

Table 11: Pin Description

Pin No.	Name	Pin Type	Buffer Type	Function
1	N.C.	N.C.		Not connected
2	RF1	I/O		RF1
3	GND	GND		Ground
4	VDD	PWR		Supply voltage
5	N.C.	N.C.		Not connected
6	CTRL	I		Control Pin
7	GND	GND		Ground
8	RF2	I/O		RF2
9	N.C.	N.C.		Not connected
10	RFC	I/O		Common RF

Table 12: Mechanical Data

Parameter	Symbol	Value	Unit
X-Dimension	<i>X</i>	1.1 ± 0.05	mm
Y-Dimension	<i>Y</i>	1.5 ± 0.05	mm
Size	<i>Size</i>	1.65	mm <sup>2</sup>
Height	<i>H</i>	0.375	mm



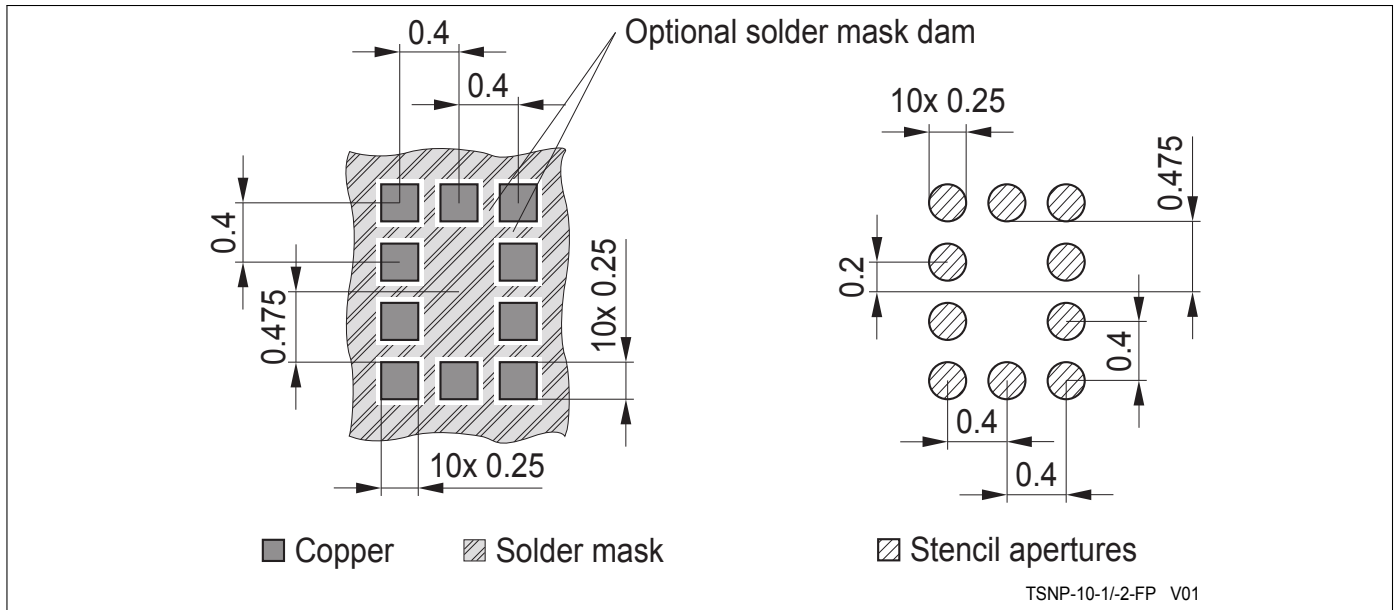

Figure 5: Land pattern and stencil mask (TSNP-10-1/-2)

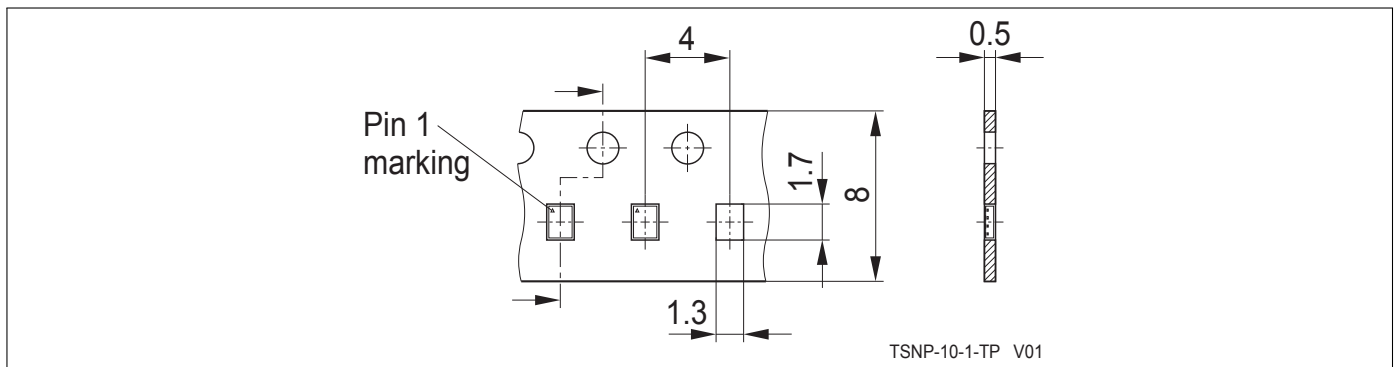

Figure 6: Tape drawing (TSNP-10-1)

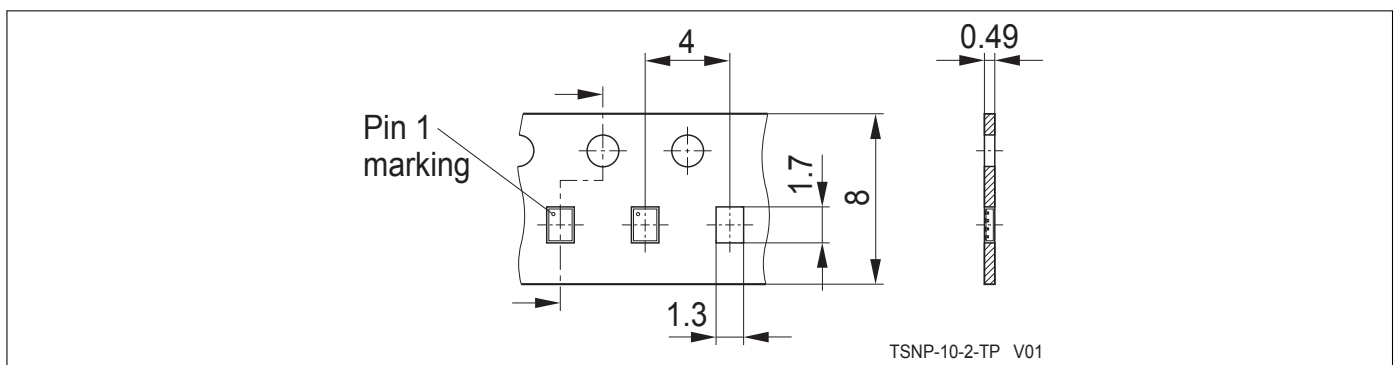
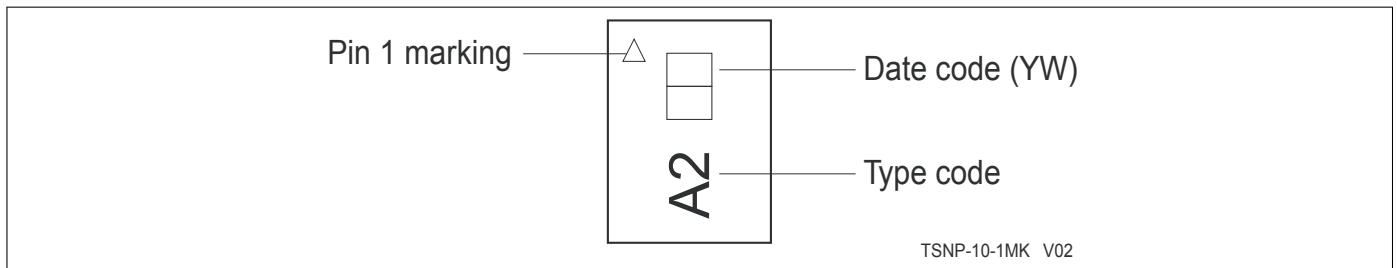
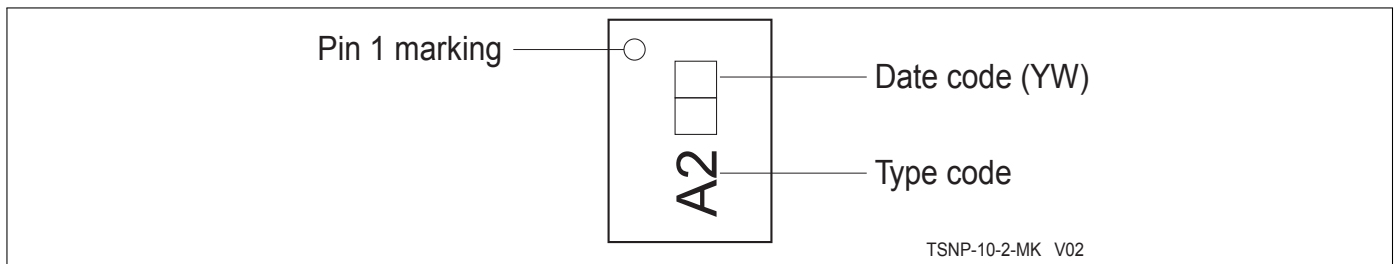

Figure 7: Tape drawing (TSNP-10-2)



**Figure 8:** Package marking (TSNP-10-1): Date code digits Y and W are found in Table 13/14



**Figure 9:** Package marking (TSNP-10-2): Date code digits Y and W are found in Table 13/14

**Table 13: Year date code marking - digit "Y"**

Year	"Y"	Year	"Y"	Year	"Y"
2000	0	2010	0	2020	0
2001	1	2011	1	2021	1
2002	2	2012	2	2022	2
2003	3	2013	3	2023	3
2004	4	2014	4	2024	4
2005	5	2015	5	2025	5
2006	6	2016	6	2026	6
2007	7	2017	7	2027	7
2008	8	2018	8	2028	8
2009	9	2019	9	2029	9

**Table 14: Week date code marking - digit "W"**

Week	"W"	Week	"W"	Week	"W"	Week	"W"	Week	"W"
1	A	12	N	23	4	34	h	45	v
2	B	13	P	24	5	35	j	46	x
3	C	14	Q	25	6	36	k	47	y
4	D	15	R	26	7	37	l	48	z
5	E	16	S	27	a	38	n	49	8
6	F	17	T	28	b	39	p	50	9
7	G	18	U	29	c	40	q	51	2
8	H	19	V	30	d	41	r	52	3
9	J	20	W	31	e	42	s		
10	K	21	Y	32	f	43	t		
11	L	22	Z	33	g	44	u		

[www.infineon.com](http://www.infineon.com)

Published by Infineon Technologies AG