

GNSS LOW NOISE AMPLIFIER

■ GENERAL DESCRIPTION

The NJG1150UA2 is a low noise amplifier GaAs MMIC designed for GNSS (Global Navigation Satellite Systems).

The NJG1150UA2 is featured low noise figure and low distortion, and operates from 1.5V to 3.3V single voltage. The NJG1150UA2 has stand-by mode to save the supply current, has the on-chip ESD protection devices.

The NJG1150UA2 achieves very small mounting area by only two external components and very small package that is lead-free and halogen-free 6-pin EPFFP6-A2 package.

■ PACKAGE OUTLINE

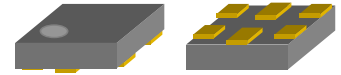

NJG1150UA2

■ APPLICATIONS

GNSS applications, like GPS, Galileo, GLONASS and COMPASS.

■ FEATURES

- Low supply voltage 1.8/ 2.8V typ.
- Low current consumption 4.2 / 4.9mA typ. @ $V_{DD}=1.8/ 2.8V$, $V_{CTL}=1.8V$
0.1 μ A typ. @ $V_{DD}=1.8/ 2.8V$, $V_{CTL}=0V$ (Stand-by mode)
- High gain 16.0dB typ. @ $V_{DD}=1.8/ 2.8V$, $V_{CTL}=1.8V$, $f=1575MHz$
- Low noise figure 0.6dB typ. @ $V_{DD}=1.8/ 2.8V$, $V_{CTL}=1.8V$, $f=1575MHz$
- High input IP3 -1 / +1dBm typ. @ $V_{DD}=1.8/ 2.8V$, $V_{CTL}=1.8V$, $f=1575+1575.1MHz$
- High out of band input IP3 +5 / +6dBm typ. @ $V_{DD}=1.8/ 2.8V$, $V_{CTL}=1.8V$, $f=1712.7+1850MHz$
- Small package EPFFP6-A2 (Package size: 1.0mmx1.0mmx0.37mm typ.)
- RoHS compliant and Halogen Free
- MSL1

■ PIN CONFIGURATION

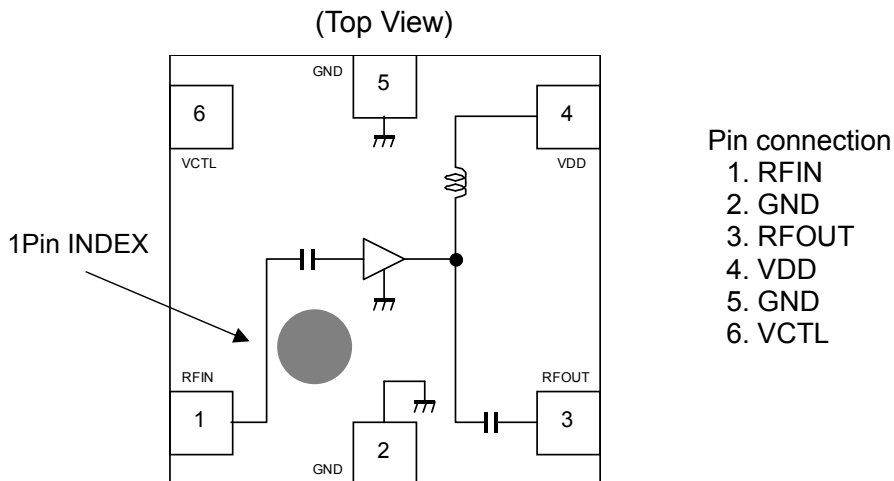

■ TRUTH TABLE

“H”= $V_{CTL}(H)$, “L”= $V_{CTL}(L)$

VCTL	LNA Mode
H	Active mode
L	Stand-by mode

Note: Specifications and description listed in this datasheet are subject to change without notice.

■ ABSOLUTE MAXIMUM RATINGS

$T_a=+25^{\circ}\text{C}$, $Z_s=Z_l=50\Omega$

PARAMETERS	SYMBOL	CONDITIONS	RATINGS	UNITS
Supply voltage	V_{DD}		5.0	V
Control voltage	V_{CTL}		5.0	V
Input power	P_{IN}	$V_{DD}=2.8\text{V}$	+15	dBm
Power dissipation	P_D	4-layer FR4 PCB with through-hole (101.5mmx114.5mm), $T_j=150^{\circ}\text{C}$	590	mW
Operating temperature	T_{opr}		-40~+85	$^{\circ}\text{C}$
Storage temperature	T_{stg}		-55~+150	$^{\circ}\text{C}$

■ ELECTRICAL CHARACTERISTICS 1 (DC)

General conditions: $T_a=+25^{\circ}\text{C}$

PARAMETER	SYMBOL	CONDITIONS	MIN	TYP	MAX	UNITS
Supply Voltage	V_{DD}		1.5	-	3.3	V
Control Voltage (High)	$V_{CTL(H)}$		1.5	1.8	3.3	V
Control Voltage (Low)	$V_{CTL(L)}$		0	0	0.3	V
Supply Current1	I_{DD1}	Active mode, $V_{DD}=2.8\text{V}$, $V_{CTL}=1.8\text{V}$	-	4.9	8.0	mA
Supply Current2	I_{DD2}	Active mode, $V_{DD}=1.8\text{V}$, $V_{CTL}=1.8\text{V}$	-	4.2	7.0	mA
Supply Current3	I_{DD3}	Stand-by mode, $V_{DD}=2.8\text{V}$, $V_{CTL}=0\text{V}$	-	0.1	3.0	μA
Supply Current4	I_{DD4}	Stand-by mode, $V_{DD}=1.8\text{V}$, $V_{CTL}=0\text{V}$	-	0.1	3.0	μA
Control Current	I_{CTL}	$V_{CTL}=1.8\text{V}$	-	5.0	12.0	μA

■ ELECTRICAL CHARACTERISTICS 2 (RF)

General conditions: $V_{DD}=2.8V$, $V_{CTL}=1.8V$, $f_{RF}=1555\sim 1610MHz$, $T_a=+25^{\circ}C$, $Z_s=Z_l=50\Omega$, with application circuit1

PARAMETER	SYMBOL	CONDITIONS	MIN	TYP	MAX	UNITS
Small Signal Gain1	Gain1	Exclude PCB and connector Losses (0.17dB)	14.5	16.0	17.0	dB
Noise Figure1	NF1	Exclude PCB and connector Losses (0.08dB)	-	0.6	0.9	dB
Input Power at 1dB Gain Compression Point1	P_{-1dB} (IN)1		-12.0	-7.0	-	dBm
Input 3rd Order Intercept Point1	IIP3_1	$f_1=f_{RF}$, $f_2=f_1\pm 1MHz$, Pin=-30dBm	-1.0	+1.0	-	dBm
Out of Band Input 3rd Order Intercept Point1	IIP3_OB1	$f_1=1712.7MHz$ Pin =-20dBm, $f_2=1850MHz$ Pin =-65dBm	+2.0	+6.0	-	dBm
700MHz Harmonic1	2fo1	Input jammer tone: 787.76MHz at -25dBm Measure the harmonic tone at 1575.52MHz	-	-45.0	-	dBm
RF IN VSWR1	VSWRi1		-	1.9	2.4	-
RF OUT VSWR1	VSWRo1		-	1.8	2.3	-

■ ELECTRICAL CHARACTERISTICS 3 (RF)

General conditions: $V_{DD}=1.8V$, $V_{CTL}=1.8V$, $f_{RF}=1555\sim 1610MHz$, $T_a=+25^{\circ}C$, $Z_s=Z_l=50\Omega$, with application circuit2

PARAMETER	SYMBOL	CONDITIONS	MIN	TYP	MAX	UNITS
Small Signal Gain2	Gain2	Exclude PCB and connector Losses (0.17dB)	14.0	16.0	17.0	dB
Noise Figure2	NF2	Exclude PCB and connector Losses (0.08dB)	-	0.6	0.95	dB
Input Power at 1dB Gain Compression Point2	P_{-1dB} (IN)2		-14.0	-9.0	-	dBm
Input 3rd Order Intercept Point2	IIP3_2	$f_1=f_{RF}$, $f_2=f_1\pm 1MHz$, Pin=-30dBm	-6.0	-1.0	-	dBm
Out of Band Input 3rd Order Intercept Point2	IIP3_OB2	$f_1=1712.7MHz$ Pin =-20dBm, $f_2=1850MHz$ Pin =-65dBm	-1.0	+5.0	-	dBm
700MHz Harmonic2	2fo2	Input jammer tone: 787.76MHz at -25dBm Measure the harmonic tone at 1575.52MHz	-	-45.0	-	dBm
RF IN VSWR2	VSWRi2		-	1.9	2.6	-
RF OUT VSWR2	VSWRo2		-	1.8	2.5	-

■ TERMINAL INFORMATION

No.	SYMBOL	DESCRIPTION
1	RFIN	RF input terminal. This terminal requires only a matching inductor L1, and does not require DC blocking capacitor.
2	GND	Ground terminal. This terminal should be connected to the ground plane as close as possible for excellent RF performance.
3	RFOUT	RF output terminal. This terminal requires no DC blocking capacitor since this IC has internal output matching circuit including DC blocking capacitor.
4	VDD	Supply voltage terminal. Please connect bypass capacitor C1 with ground as close as possible.
5	GND	Ground terminal. This terminal should be connected to the ground plane as close as possible for excellent RF performance.
6	VCTL	Control voltage terminal.

ELECTRICAL CHARACTERISTICS

Conditions: $V_{DD}=2.8V$, $V_{CTL}=1.8V$, $T_a=25^\circ C$, $Z_s=Z_l=50\Omega$, with application circuit1

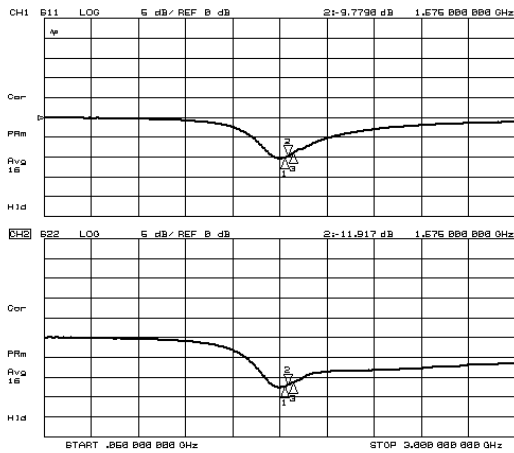

S11, S22

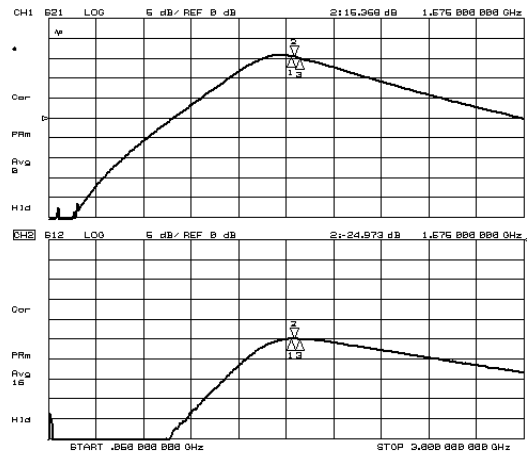

S21, S12

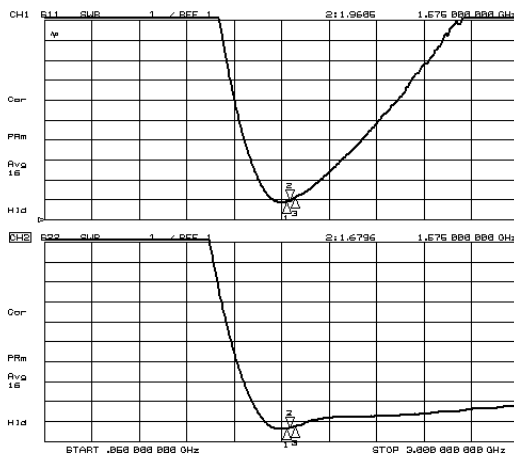

VSWRi, VSWRo

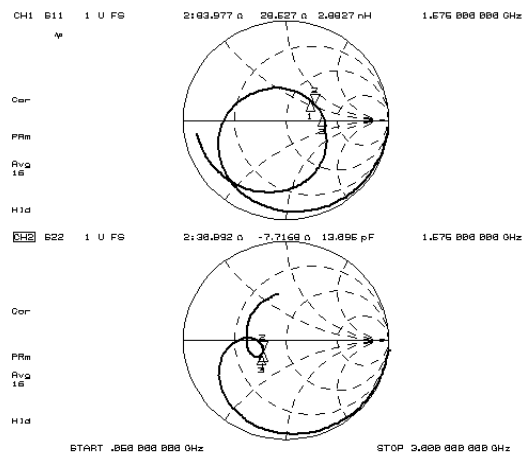

Zin, Zout

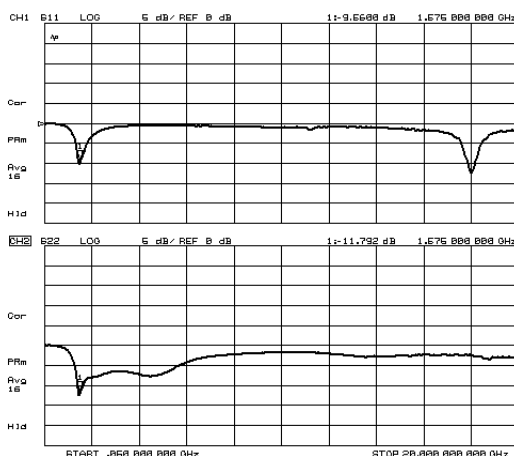

S11, S22 (50M~20GHz)

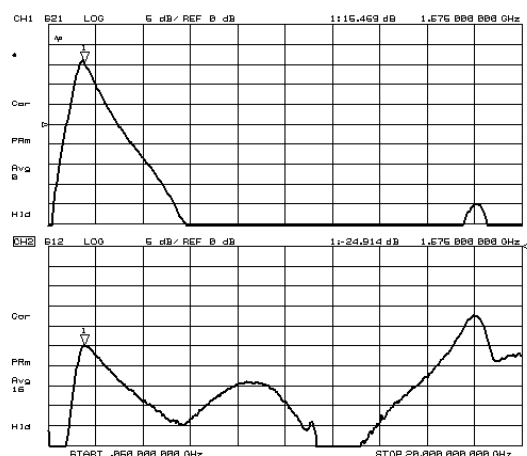

S21, S12 (50M~20GHz)

ELECTRICAL CHARACTERISTICS

Conditions: $V_{DD}=2.8V$, $V_{CTL}=1.8V$, $T_a=25^\circ C$, $Z_s=Z_l=50\Omega$, with application circuit1

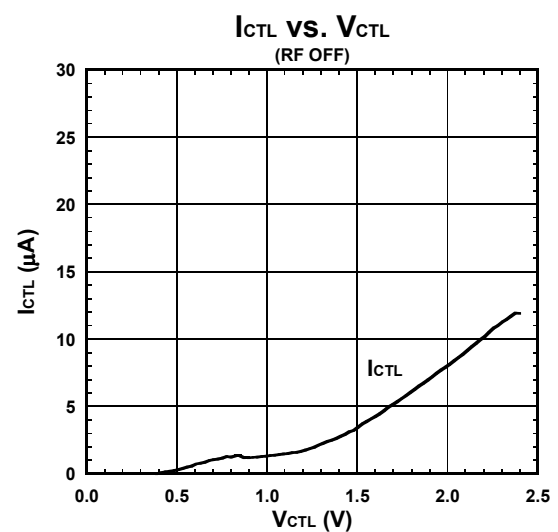
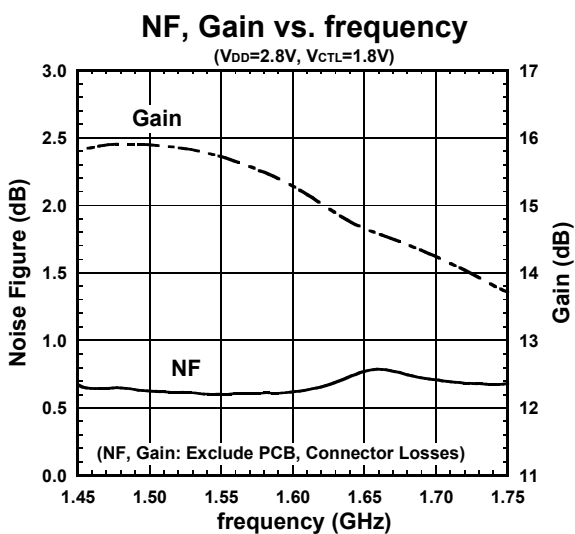
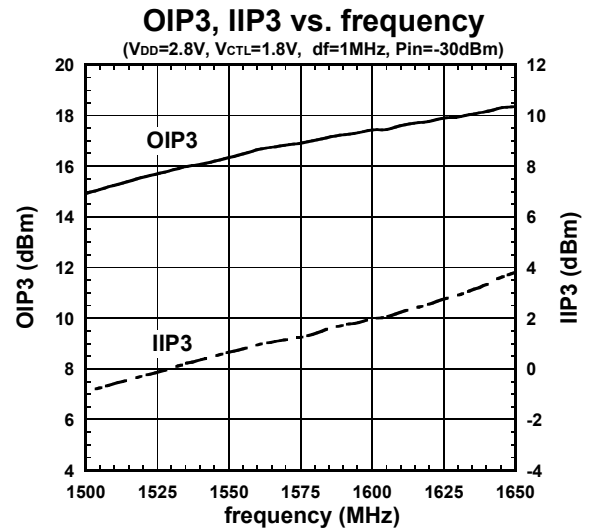
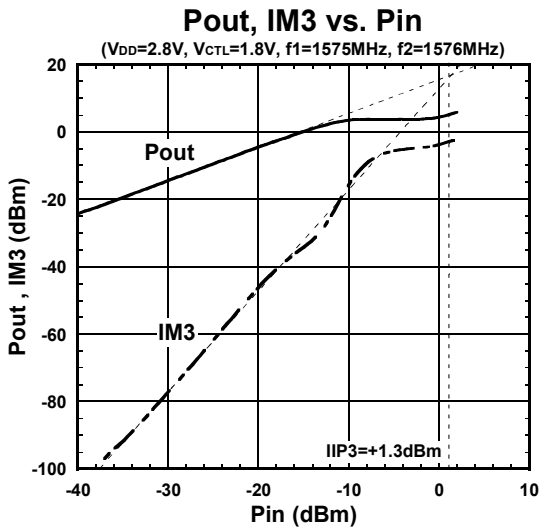
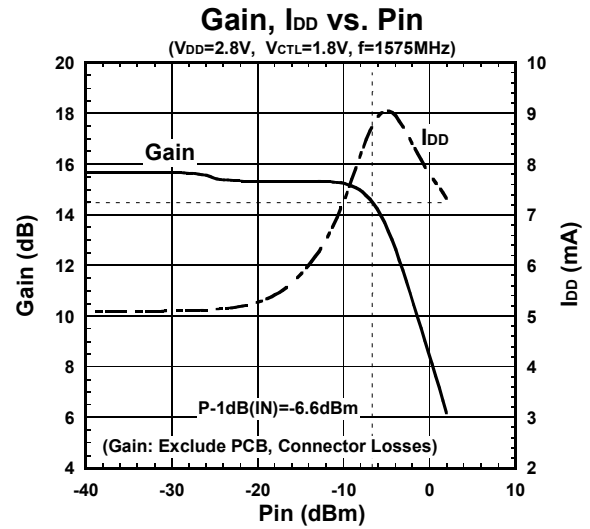
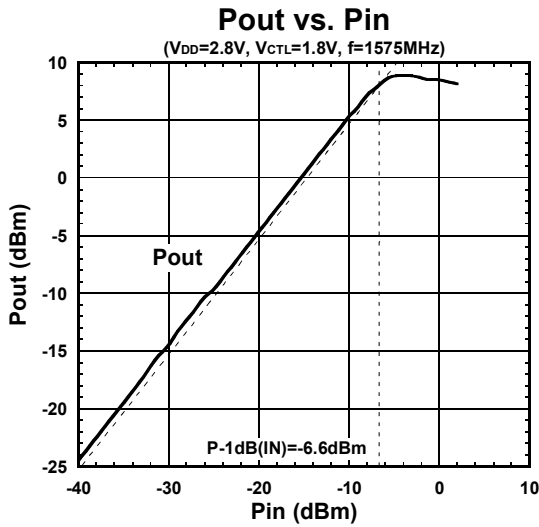

ELECTRICAL CHARACTERISTICS

Conditions: $V_{DD}=2.8V$, $V_{CTL}=1.8V$, $Z_s=Z_l=50\Omega$, with application circuit1

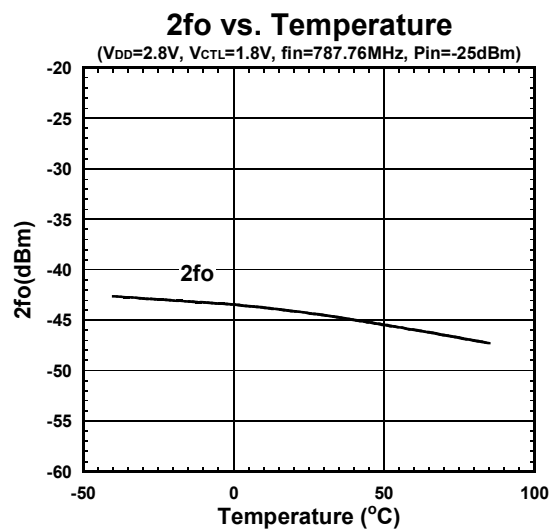
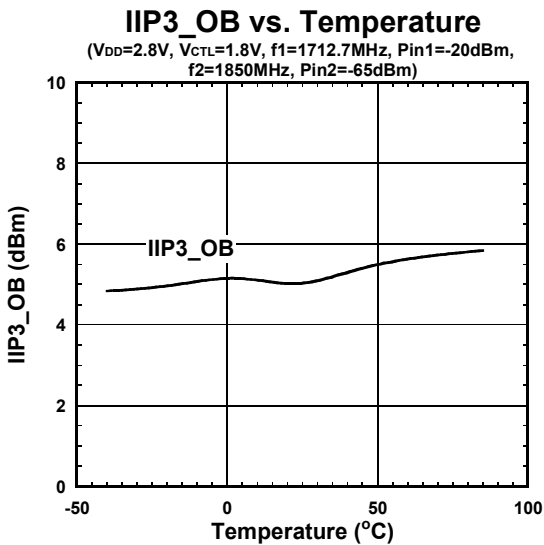
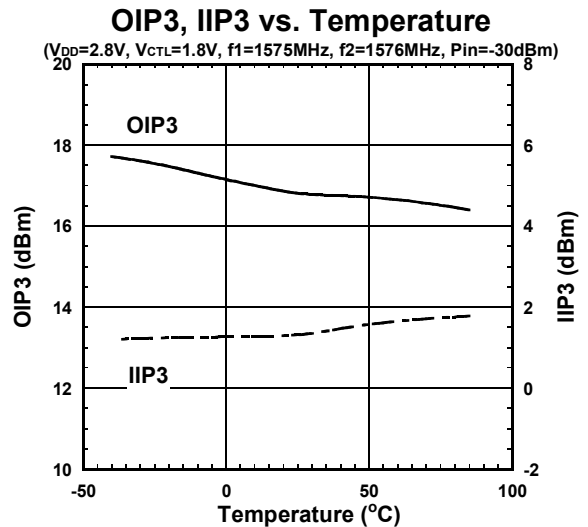
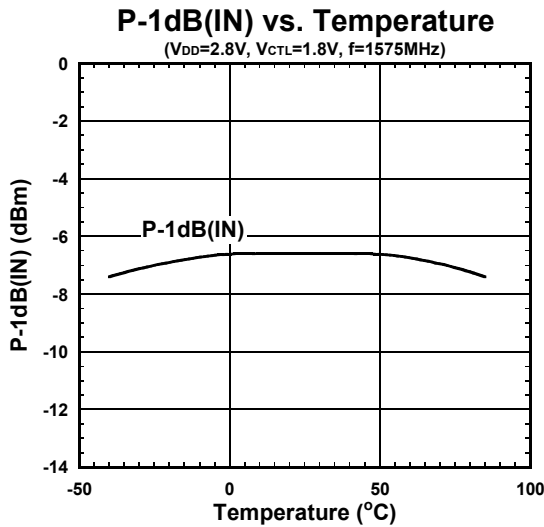
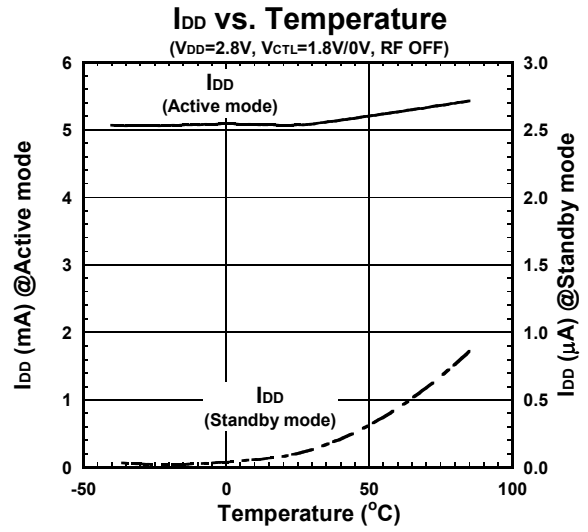
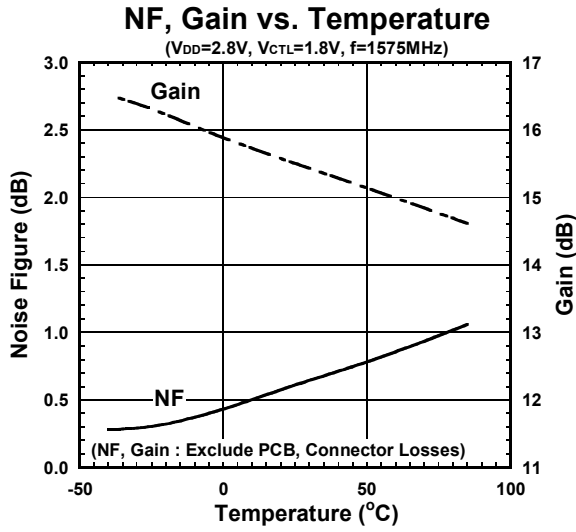

■ ELECTRICAL CHARACTERISTICS

Conditions: $V_{DD}=2.8V$, $V_{CTL}=1.8V$, $Z_s=Z_l=50\Omega$, with application circuit1

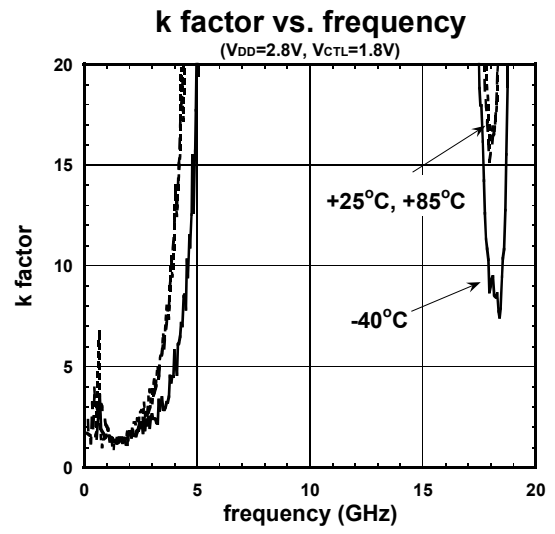
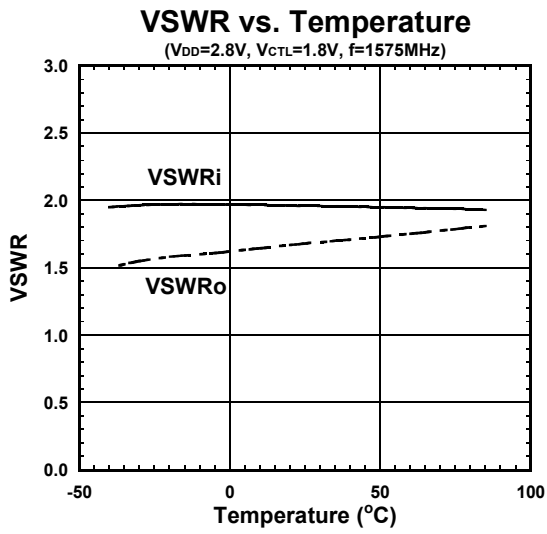

ELECTRICAL CHARACTERISTICS

Conditions: $V_{CTL}=1.8V$, $T_a=25^\circ C$, $Z_s=Z_l=50\Omega$, with application circuit1

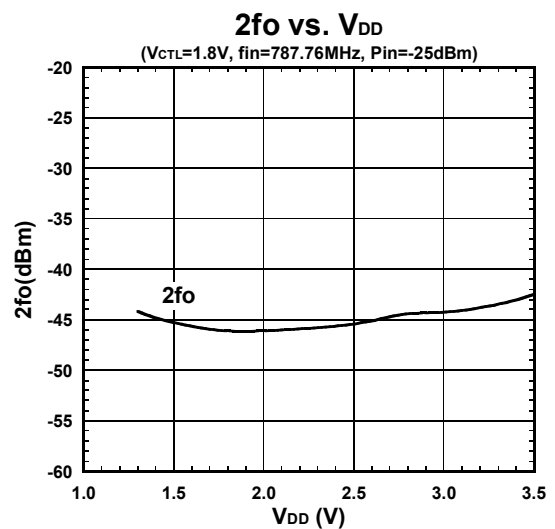
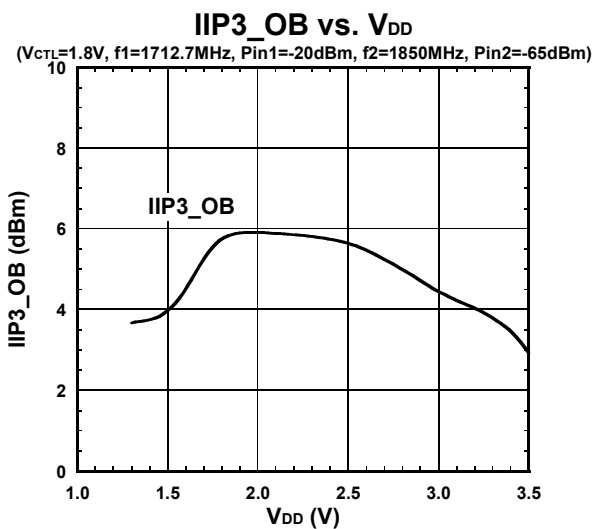
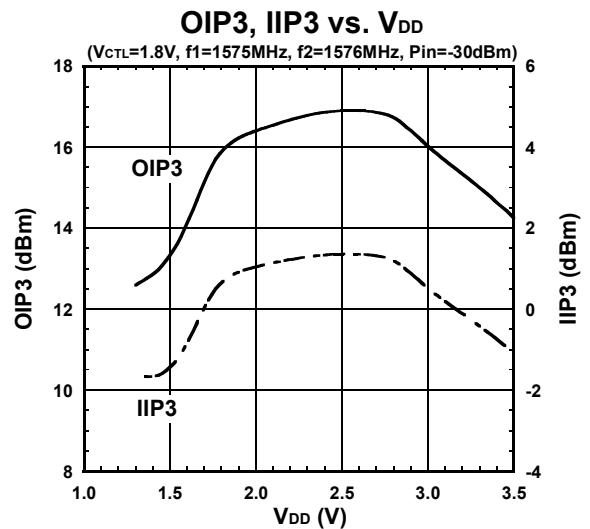
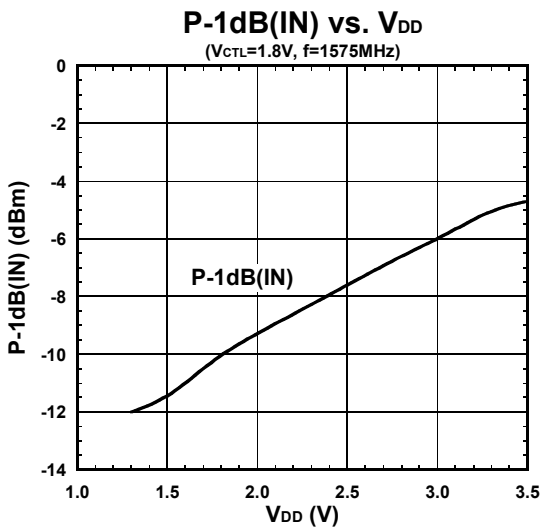
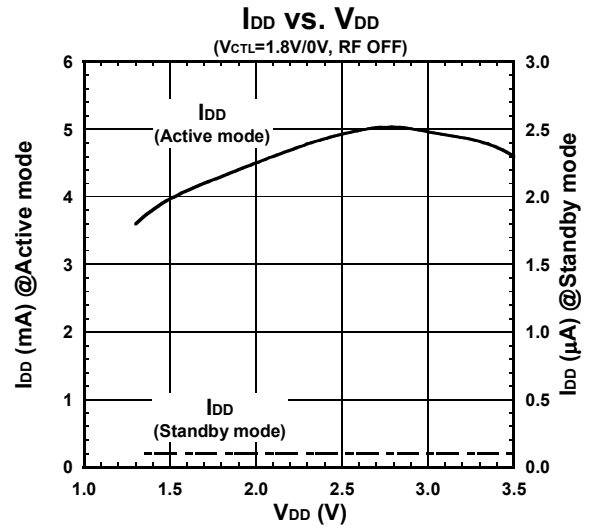
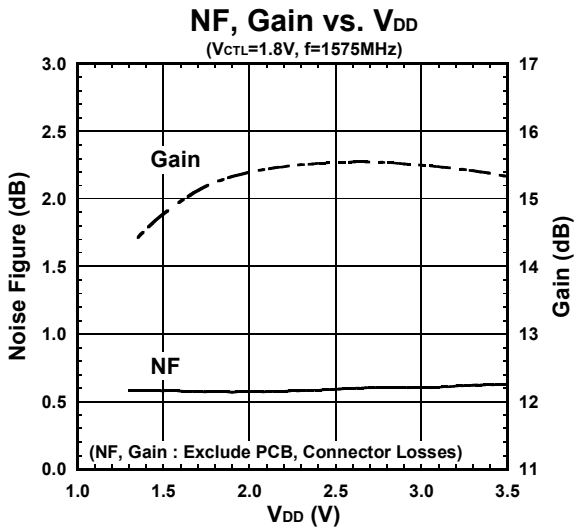

ELECTRICAL CHARACTERISTICS

Conditions: $V_{DD}=1.8V$, $V_{CTL}=1.8V$, $T_a=25^{\circ}C$, $Z_s=Z_l=50\Omega$, with application circuit2

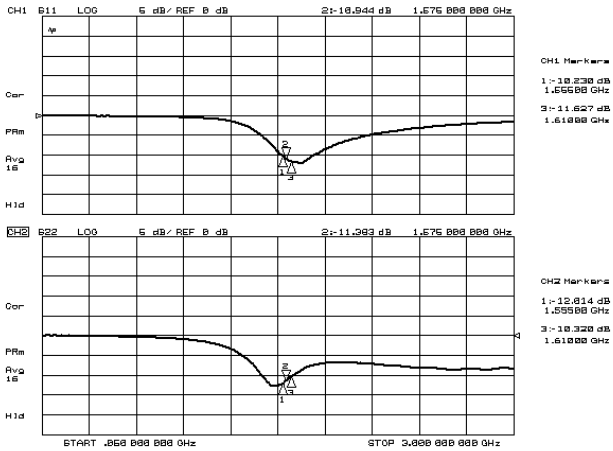

S11, S22

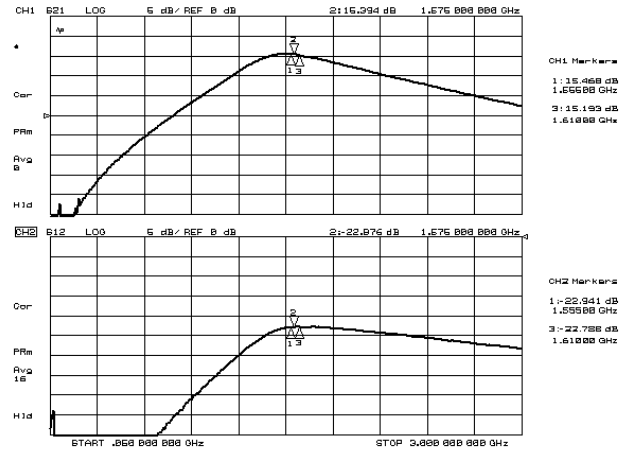

S21, S12

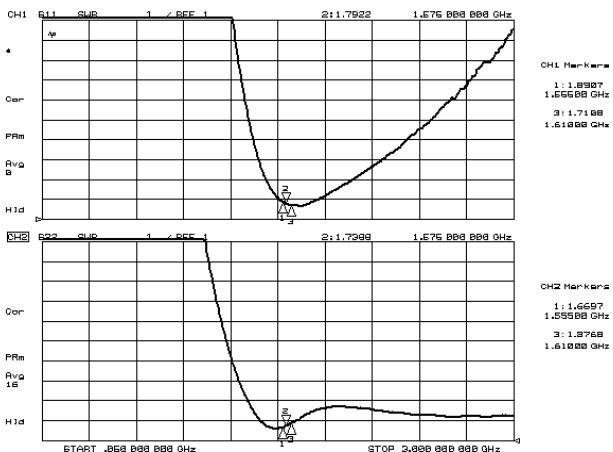

VSWRi, VSWRo

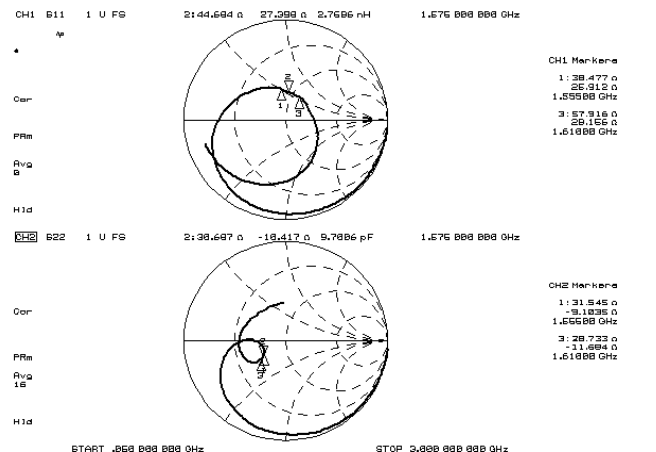

Zin, Zout

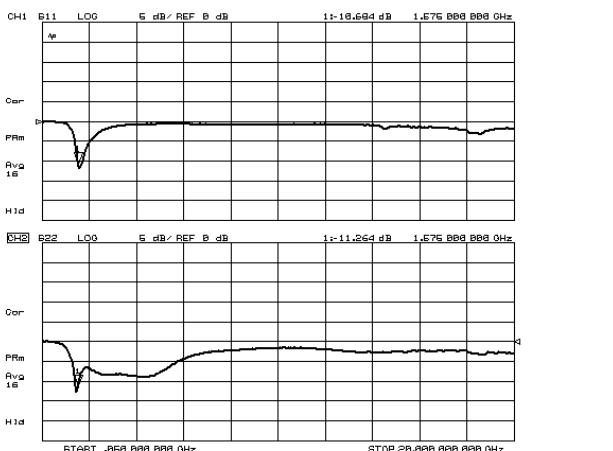

S11, S22 (50M~20GHz)

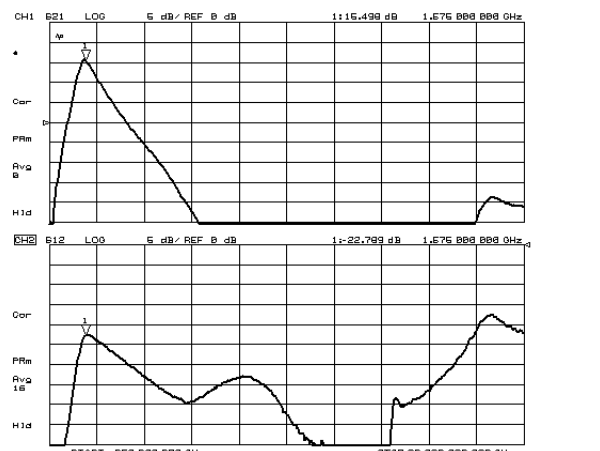

S21, S12 (50M~20GHz)

ELECTRICAL CHARACTERISTICS

Conditions: $V_{DD}=1.8V$, $V_{CTL}=1.8V$, $T_a=25^\circ C$, $Z_s=Z_l=50\Omega$, with application circuit2

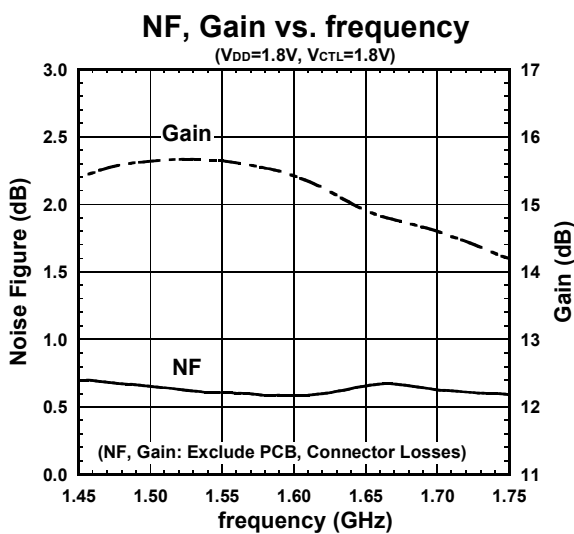
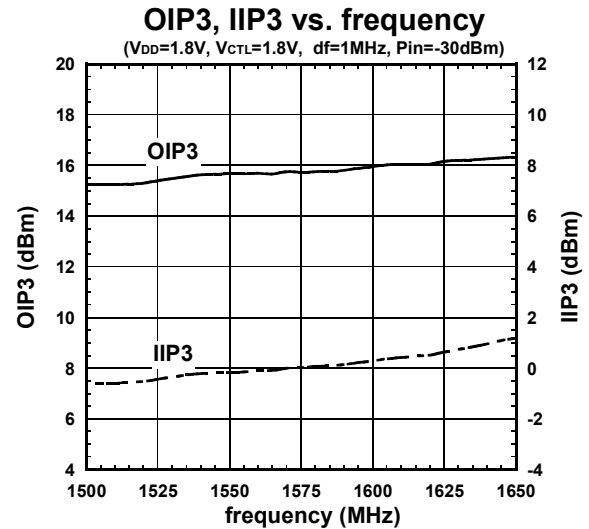
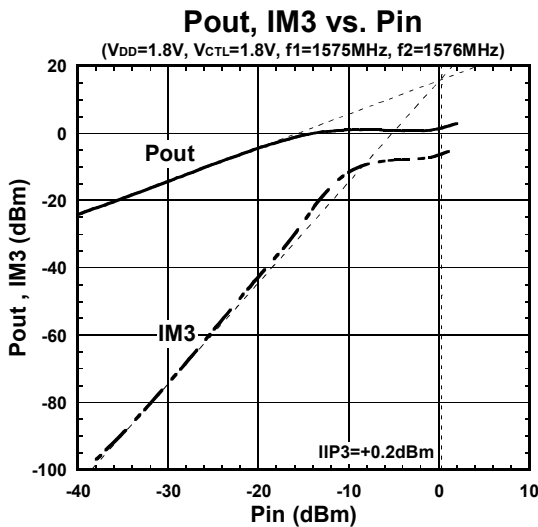
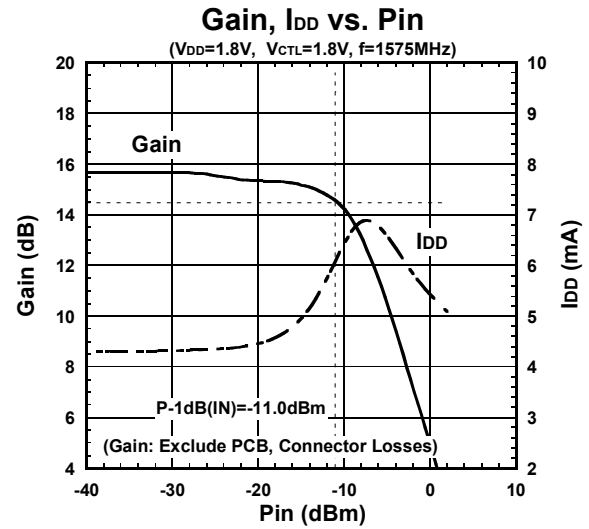
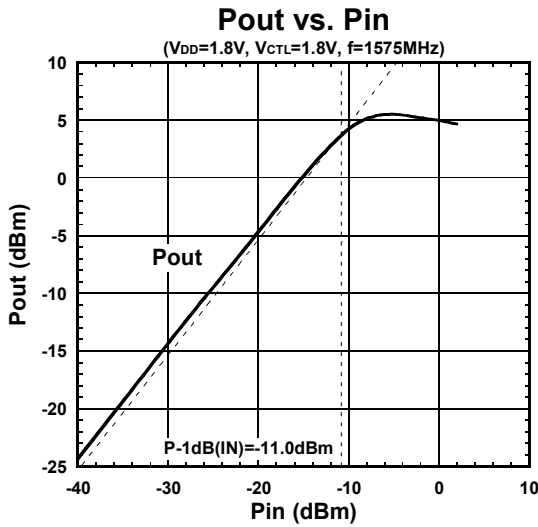

APPLICATION CIRCUIT1 ($V_{DD}=2.8V$)

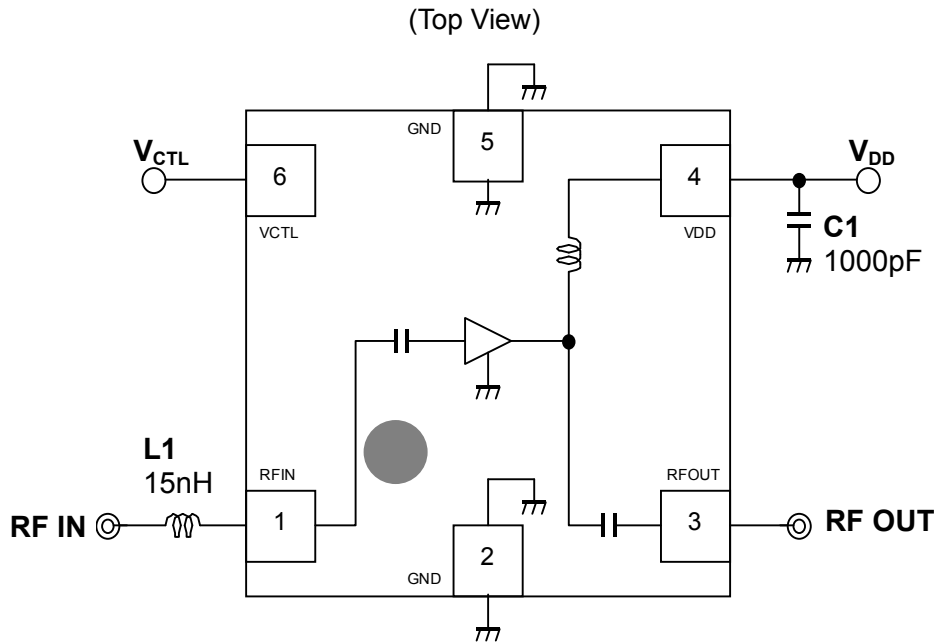

Parts list

Parts ID	Manufacture
L1	LQW15A Series (MURATA)
C1	GRM03 Series (MURATA)

APPLICATION CIRCUIT2 ($V_{DD}=1.8V$)

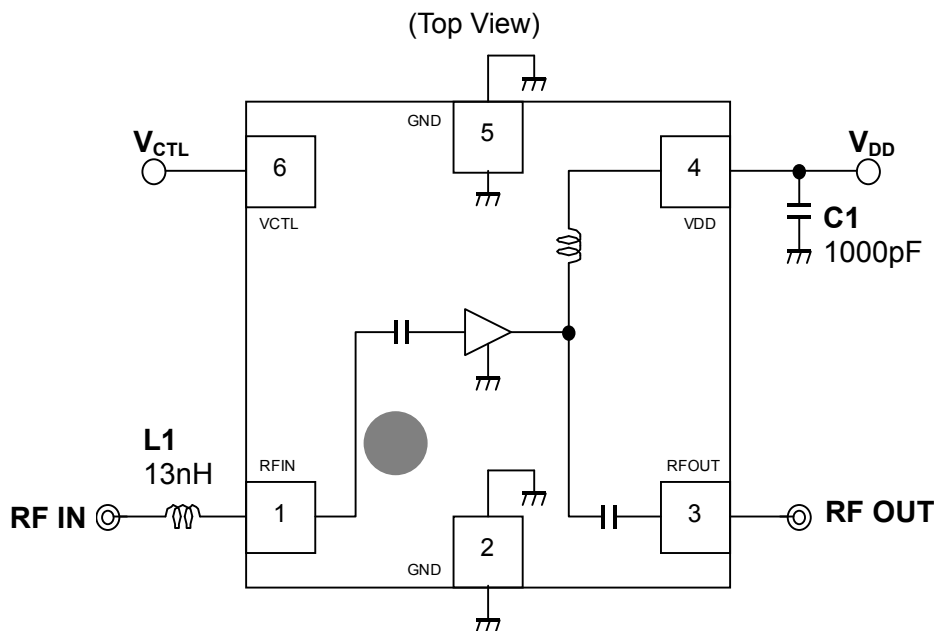

Parts list

Parts ID	Manufacture
L1	LQW15A Series (MURATA)
C1	GRM03 Series (MURATA)

■ EVALUATION BOARD



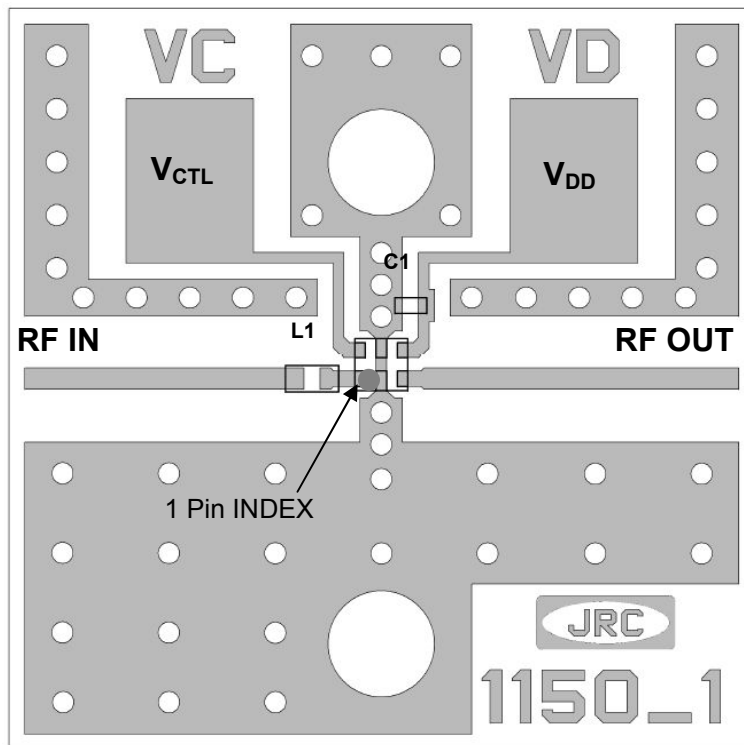

(Top View)

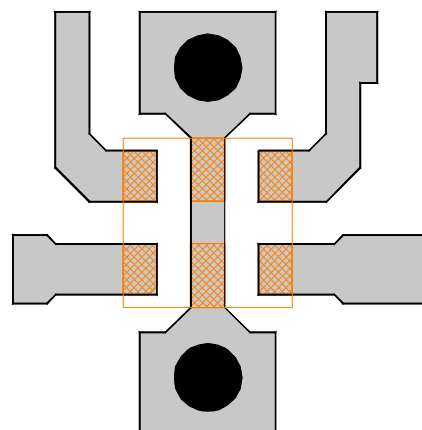

PCB (FR-4):
 $t=0.2\text{mm}$
 MICROSTRIP LINE WIDTH
 $=0.4\text{mm}$ ($Z_0=50\Omega$)
 PCB SIZE
 $=14.0\text{mm} \times 14.0\text{mm}$

<PCB LAYOUT GUIDELINE>



 PCB
 PKG Terminal
 PKG Outline
 GND Via Hole
 Diameter: $\phi=0.4\text{mm}$

PRECAUTIONS

- Please layout ground pattern under this IC in order not to couple with terminal RFIN and RFOUT.
- All external parts should be placed as close as possible to the IC.
- For good RF performance, all GND terminals must be connected to PCB ground plane of substrate, and via-holes for GND should be placed near the IC.

RECOMMENDED FOOTPRINT PATTERN (EPFFP6-A2 PACKAGE Reference)

 : Land

 : Mask (Open area) *Metal mask thickness: 100um

 : Resist (Open area)

Package: 1.0 x 1.0mm

Pin pitch: 0.4mm

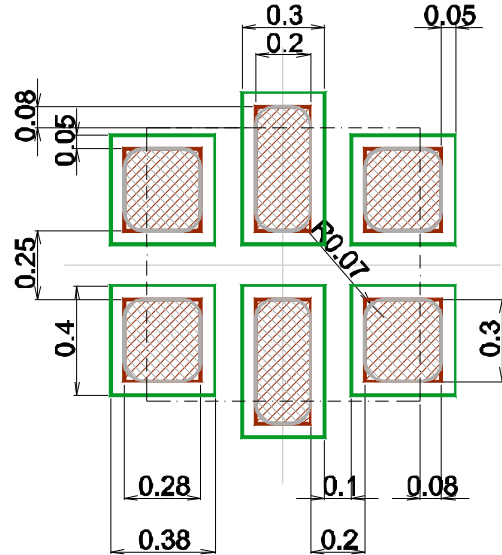

APPLICATION NOTE FOR SMALLER MOUNTING AREA (using MLG0603P Series inductor)

This application note shows an example in order to achieve smaller mounting area using smaller size external inductor L1. MLG0603P (TDK-EPC) Series inductor is used for this application. The example of electrical characteristics are shown as follows:

■ ELECTRICAL CHARACTERISTICS 4 (DC)

General conditions: $T_a=+25^{\circ}\text{C}$

PARAMETER	SYMBOL	CONDITIONS	MEASURED DATA	UNITS
Supply Voltage	V_{DD}		2.8 / 1.8	V
Control Voltage (High)	$V_{CTL(H)}$		1.8	V
Control Voltage (Low)	$V_{CTL(L)}$		0	V
Supply Current1	I_{DD1}	Active mode, $V_{DD}=2.8\text{V}$, $V_{CTL}=1.8\text{V}$	5.04	mA
Supply Current2	I_{DD2}	Active mode, $V_{DD}=1.8\text{V}$, $V_{CTL}=1.8\text{V}$	4.33	mA
Supply Current3	I_{DD3}	Stand-by mode, $V_{DD}=2.8\text{V}$, $V_{CTL}=0\text{V}$	0.1	μA
Supply Current4	I_{DD4}	Stand-by mode, $V_{DD}=1.8\text{V}$, $V_{CTL}=0\text{V}$	0.1	μA
Control Current	I_{CTL}	$V_{CTL}=1.8\text{V}$	6.0	μA

■ ELECTRICAL CHARACTERISTICS 5 (RF)

General conditions: $V_{DD}=2.8\text{V}$, $V_{CTL}=1.8\text{V}$, $f_{RF}=1555\sim 1610\text{MHz}$, $T_a=+25^{\circ}\text{C}$, $Z_s=Z_l=50\Omega$, with application circuit3

PARAMETER	SYMBOL	CONDITIONS	MEASURED DATA	UNITS
Small Signal Gain5	Gain5	Exclude PCB and connector Losses	15.3~15.7	dB
Noise Figure5	NF5	Exclude PCB and connector Losses	0.80~0.84	dB
Input Power at 1dB Gain Compression Point5	P_{-1dB} (IN)5		-8.6~-6.6	dBm
Input 3rd Order Intercept Point5	IIP3_5	$f_1=f_{RF}$, $f_2=f_1\pm 1\text{MHz}$, $\text{Pin}=-30\text{dBm}$	+0.2~+1.5	dBm
Out of Band Input 3rd Order Intercept Point5	IIP3_OB5	$f_1=1712.7\text{MHz}$ $\text{Pin}=-20\text{dBm}$, $f_2=1850\text{MHz}$ $\text{Pin}=-65\text{dBm}$	+4.3	dBm
700MHz Harmonic5	2fo5	Input jammer tone: 787.76MHz at -25dBm Measure the harmonic tone at 1575.52MHz	-44.8	dBm
RF IN VSWR5	VSWRi5		1.54~1.60	-
RF OUT VSWR5	VSWRo5		1.54~1.69	-

■ ELECTRICAL CHARACTERISTICS 6 (RF)

General conditions: $V_{DD}=1.8V$, $V_{CTL}=1.8V$, $f_{RF}=1555\sim 1610MHz$, $T_a=+25^\circ C$, $Z_s=Z_l=50\Omega$, with application circuit3

PARAMETER	SYMBOL	CONDITIONS	MEASURED DATA	UNITS
Small Signal Gain6	Gain6	Exclude PCB and connector Losses	14.9~15.4	dB
Noise Figure6	NF6	Exclude PCB and connector Losses	0.77~0.83	dB
Input Power at 1dB Gain Compression Point6	P_{-1dB} (IN)6		-10.5 ~ -10.0	dBm
Input 3rd Order Intercept Point6	IIP3_6	$f_1=f_{RF}$, $f_2=f_1\pm 1MHz$, Pin=-30dBm	+0.5 ~ +1.2	dBm
Out of Band Input 3rd Order Intercept Point6	IIP3_OB6	$f_1=1712.7MHz$ Pin =-20dBm, $f_2=1850MHz$ Pin =-65dBm	+5.8	dBm
700MHz Harmonic6	2fo6	Input jammer tone: 787.76MHz at -25dBm Measure the harmonic tone at 1575.52MHz	-45.5	dBm
RF IN VSWR6	VSWRi6		1.67~1.78	-
RF OUT VSWR6	VSWRo6		1.87~2.11	-

APPLICATION CIRCUIT3 (Using MLG0603P Series inductor)

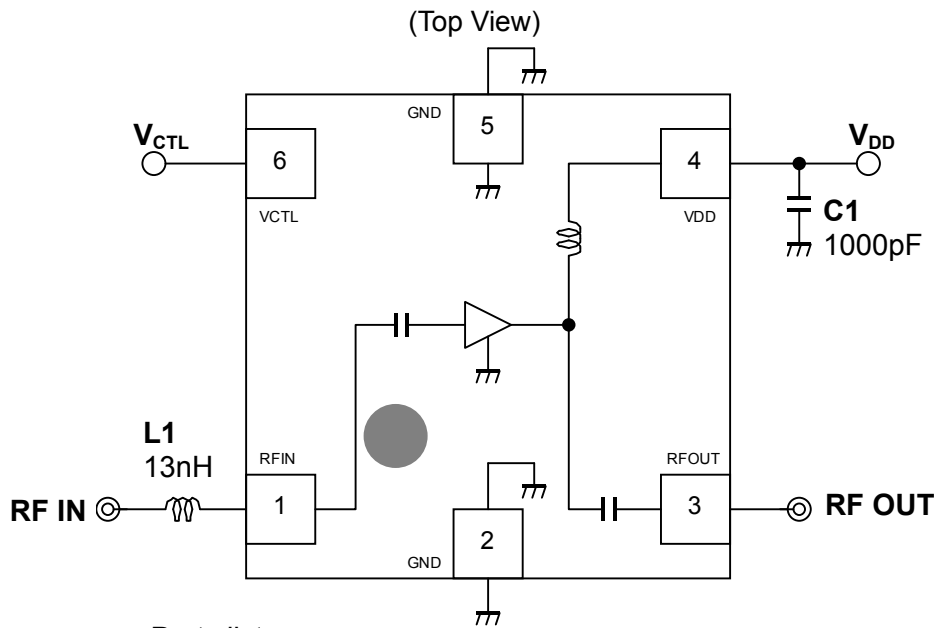

Parts list

Parts ID	Manufacture
L1	MLG0603P (TDK-EPC)
C1	GRM03 Series (MURATA)

EVALUATION BOARD (Using MLG0603P Series)

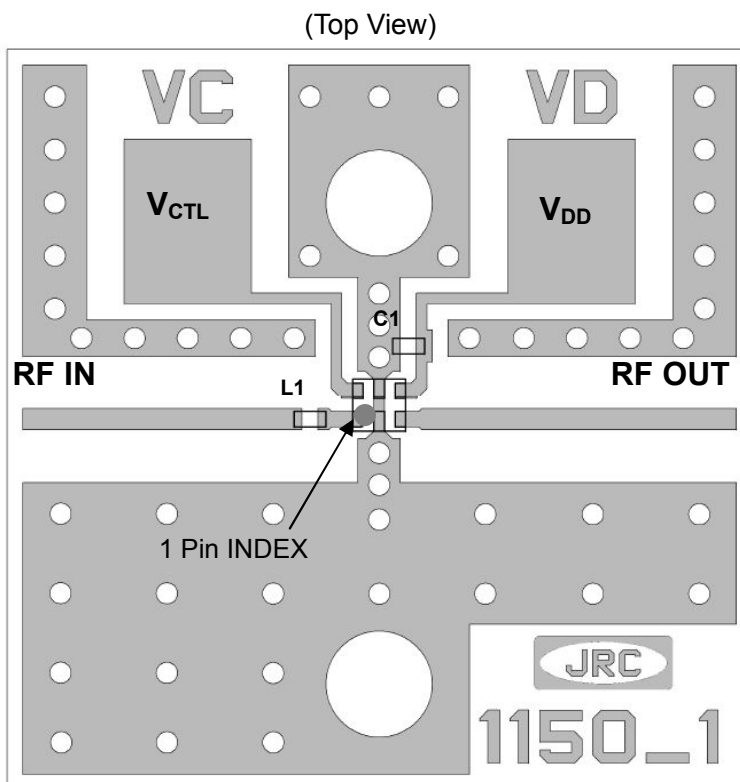

PCB (FR-4):
 $t=0.2\text{mm}$
 MICROSTRIP LINE WIDTH
 $=0.4\text{mm}$ ($Z_0=50\Omega$)
 PCB SIZE
 $=14.0\text{mm} \times 14.0\text{mm}$

■ NOISE FIGURE MEASUREMENT BLOCK DIAGRAM

Measuring instruments

NF Analyzer : Agilent N8973A
 Noise Source : Agilent 346A

Setting the NF analyzer

Measurement mode form

Device under test : Amplifier
 System downconverter : off

Mode setup form

Sideband : LSB
 Averages : 16
 Average mode : Point
 Bandwidth : 4MHz
 Loss comp : off
 Tcold : setting the temperature of noise source (303.15K)

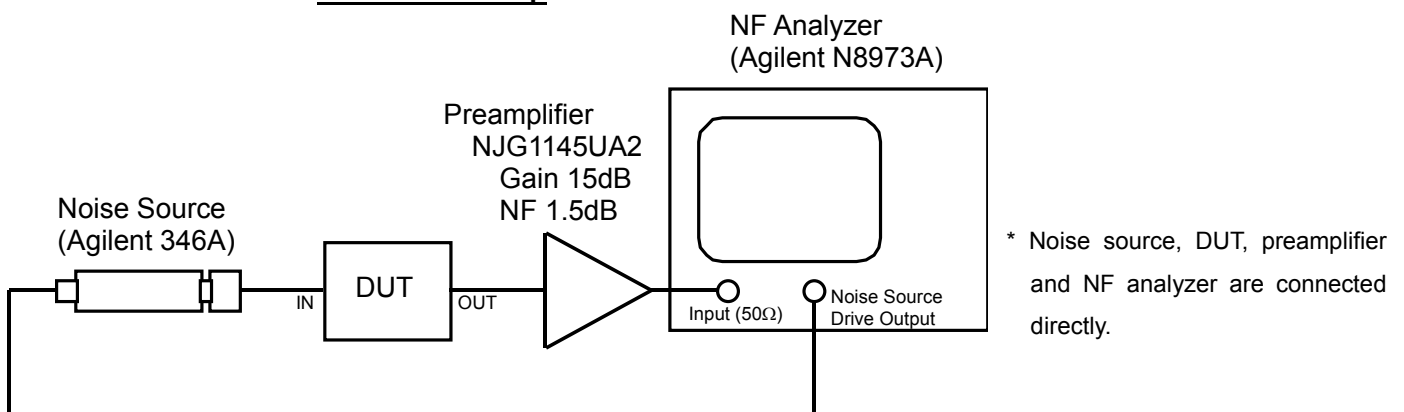
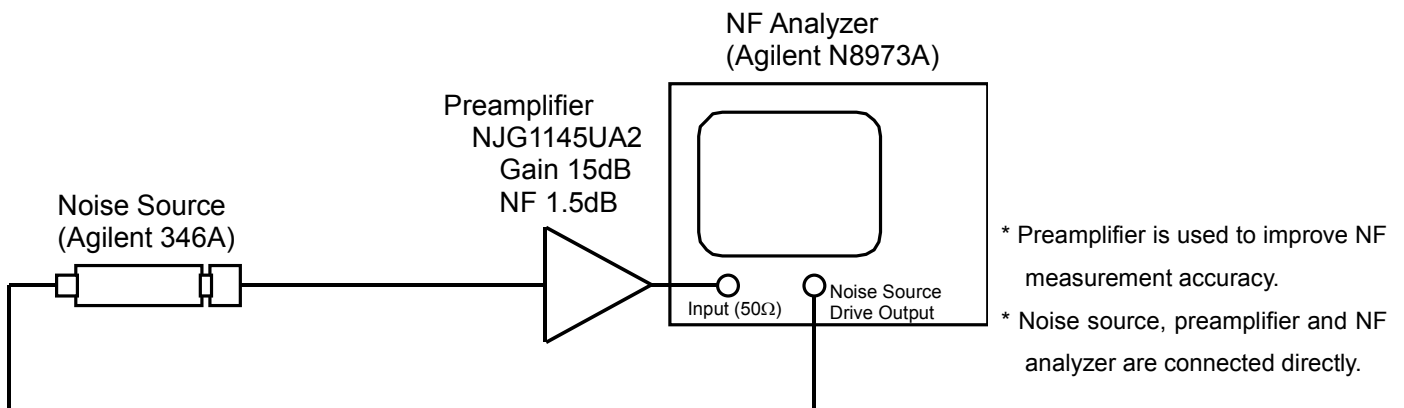

PACKAGE OUTLINE (EPFFP6-A2)

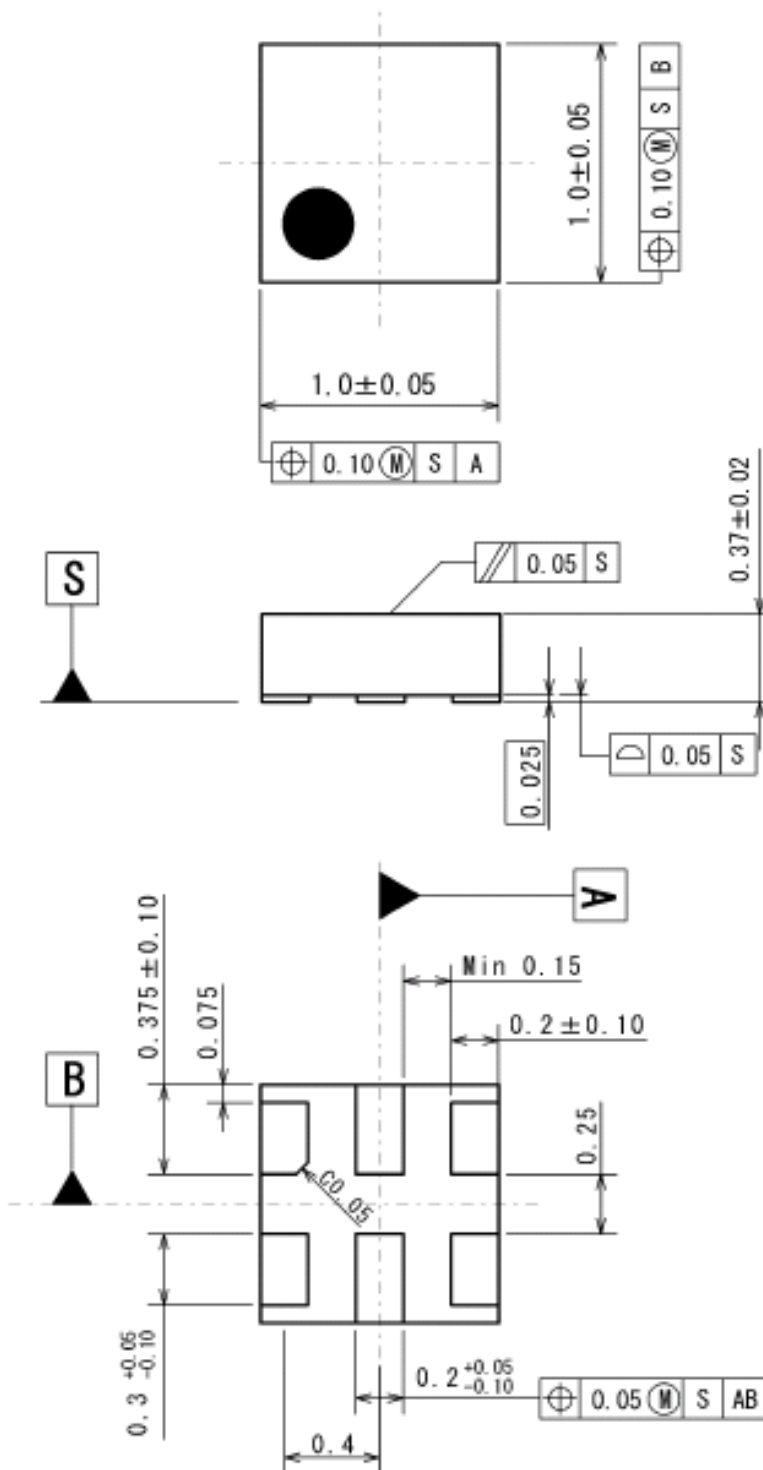

Unit : mm
 Substrate : FR4
 Terminal treat : Au
 Molding material : Epoxy resin
 Weight (typ.) : 0.855mg

Cautions on using this product

This product contains Gallium-Arsenide (GaAs) which is a harmful material.

- Do NOT eat or put into mouth.
- Do NOT dispose in fire or break up this product.
- Do NOT chemically make gas or powder with this product.
- To waste this product, please obey the relating law of your country.

This product may be damaged with electric static discharge (ESD) or spike voltage. Please handle with care to avoid these damages.

[CAUTION]

The specifications on this databook are only given for information, without any guarantee as regards either mistakes or omissions. The application circuits in this databook are described only to show representative usages of the product and not intended for the guarantee or permission of any right including the industrial rights.

Mouser Electronics

Authorized Distributor

Click to View Pricing, Inventory, Delivery & Lifecycle Information:

[NJR:](#)

[NJG1150UA2-TE1](#)