

SPECIFICATION

Part No. : **CAB.721**

Product Name : Taoglas Cable Assembly
Hirose U.FL to SMA(F)Bulkhead Straight Connector
with 100mm \varnothing 1.32 cable

Photo :



1. Cable Insertion Loss

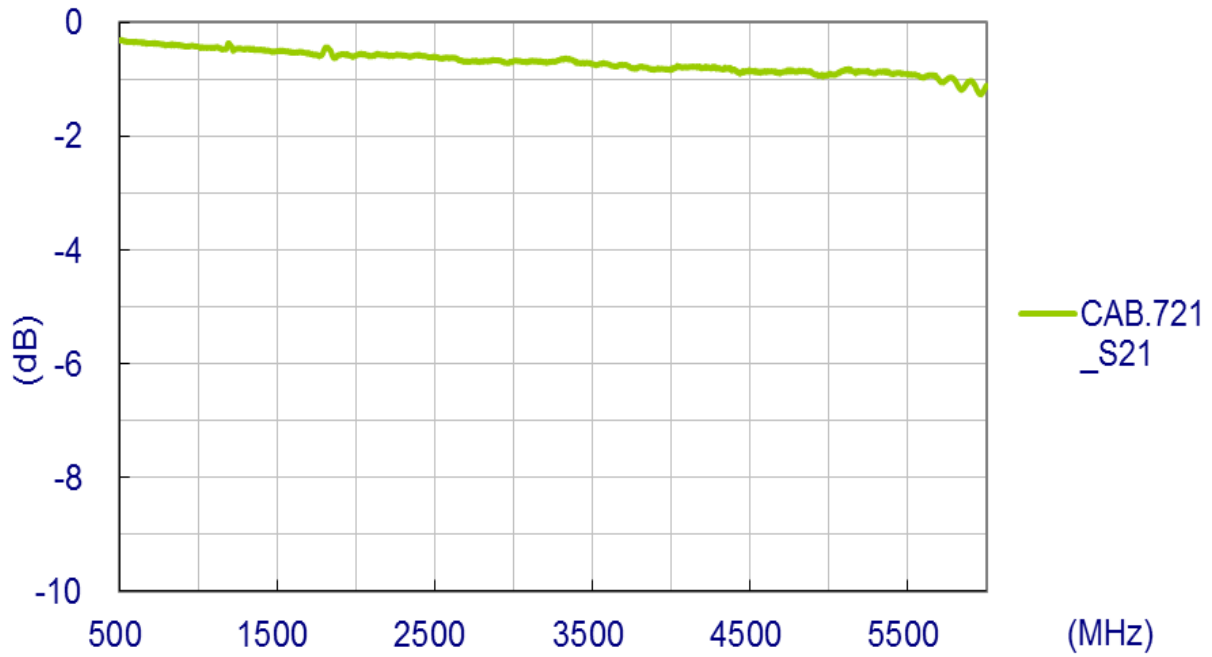

2. 1.32 Cable Specification

2.1 Drawing – Cross Section

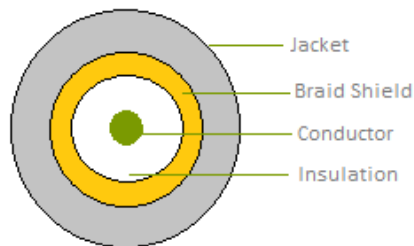

2.2 Structure and Dimensions

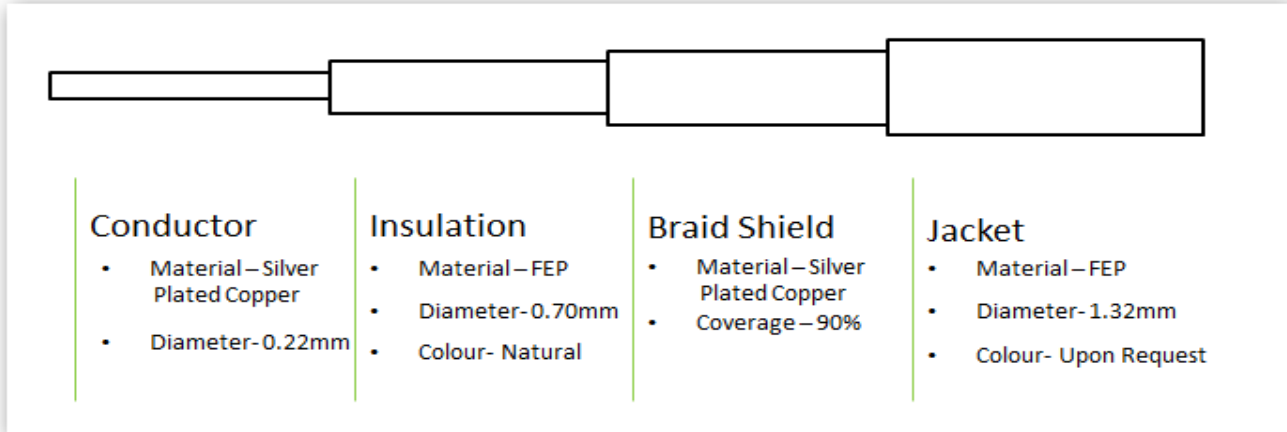

2.3 Electrical & Physical Specification

1	Item:	32 AWG		
2	Rating Temp Voltage:	105°C 30V UL 1979		
3	Insulation Resistance:	1000 MEGA OHM-KM Min.		
4	Conductor Resistance:	545 OHM/KM/20°C Max.		
5	Dielectric Strength:	AC 1.0 KV/minute		
6	Spark test:	2.5 KV		
7	Insulation	Unaged	Tensile Strength Elongation	2500 PSI Min.(1.76Kg/mm ²) 200% min.
		Aged	Tensile Strength Elongation	Unaged Min 75%(168HRS*232°C) Unaged Min 75%(168HRS*232°C)
8	Jacket	Unaged	Tensile Strength Elongation	2500 PSI Min.(1.76Kg/mm ²) 200% min.
		Aged	Tensile Strength Elongation	Unaged Min 75%(168HRS*232°C) Unaged Min 75%(168HRS*232°C)
9	Nom. Impedance	50 ± 3 Ohms		
10	Nom. Capacitance	96 ± 3 pF/m		
11	Nom. Vel. Of Prop.	69%		
12	VSWR (0-6GHz)	Max 1.3		
13	Flame Test	VW-1 OK		
14	Attenuation (dB/1M)	2.0GHz	2.80	
		2.4GHz	3.10	
		3.0GHz	3.50	
		4.0GHz	4.00	
		5.0GHz	4.60	
		6.0GHz	5.10	

3. Technical Drawing

3.1 CAB.721

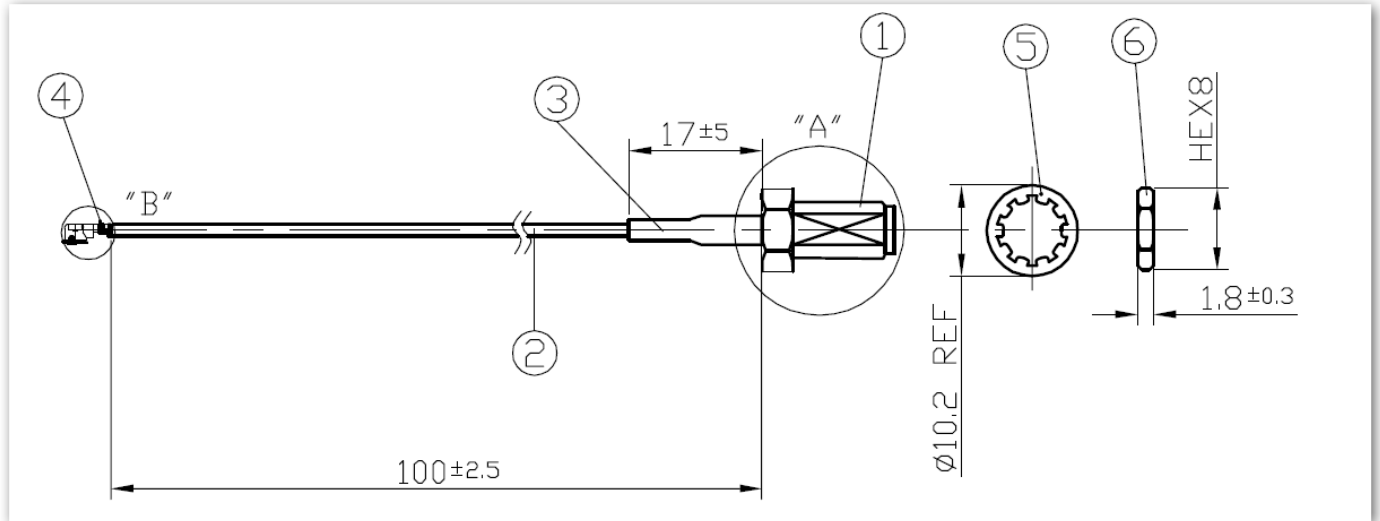

	Name	Part No.	Material	Finish	QTY
1	SMA(F)BKST	SMA.F.ST.JACK.BAHC.J	Brass	Gold	1
2	1.32 Coaxial Cable	OD.132.J	FEP	Black	1
3	Heat Shrink Tube	001311I000013A	PE	Black	1
4	Hirose U.FL	HRS.UFL.PLUG.AH	Brass	Gold \triangle_B	1
5	Washer	See Connector Spec	Brass	Gold	1
6	Nut	See Connector Spec	Brass	Gold	1

3.2 Connectors

