

CFT-90-W Specialty White LED



Table of Contents

General Considerations	2
Flux Binning Structure	3
Chromaticity Bins	4-5
Ordering Information	6
Product Characteristics	7
Optical and Thermal Characteristics	8
Mechanical Dimensions	10
Shipping Tray Outline	11
Packing and Shipping	12
History of Changes	13

Features:

- Second generation monolithic 9 mm² specialty white LED delivers increased peak lumens and drive current over CBT-90-W
- High current operation: up to 27 A DC
- Over 5500 lumens at maximum drive current
- Available in 5700K, 6500K and 7800K (typ) color temperatures
- Window-less package design improves optical coupling efficiency
- Low thermal resistance chip-on-board packaging technology: 0.45 °C/W typical junction to back of core board.
- New common cathode chip technology delivers increased performance and simplifies system design
- Hot lumens specification, production tested at 22.5 A DC, 90 °C junction temperature
- Environmentally friendly, compliant with RoHS and REACH requirements

Applications

- Fiber illumination including:
 - medical endoscopy
 - machine vision
 - microscopy and other instrumentation
- Inspection and industrial applications
- Stage and Entertainment spot lights, narrow beam projectors
- Architectural Lighting
- Off-road vehicle and truck projector lights
- Search Lights
- Beacons

General Considerations

Environmental Considerations:

As a leading provider of solid-state Lighting solutions, Luminus implements strict substance control policies to ensure all of its products are environmentally friendly. As with all Luminus LEDs, the CFT-90-W series are compliant with the Restriction of Hazardous Substances (RoHS) and REACH directives from the European Community.

Product Testing:

Every CFT-90-W LED is fully production tested to ensure it meets the high quality standards customers have come to expect from Luminus products. Devices are tested and binned at a controlled 40°C heat sink temperature and with a 22.5 A DC current, corresponding to a nominal junction temperature of 90°C. As a result, the devices lumens and chromaticity are binned “hot” and their characteristics are close to in-system operating conditions. Current and temperature curves are provided in this document allowing users to predict the LED performance and characteristics under their own driving and thermal conditions.

Reliability:

Luminus CFT-90-W LED series are required to pass a rigorous suite of environmental and mechanical stress tests, including mechanical shock, vibration, temperature cycling and humidity. These tests ensure that the devices deliver high performance and achieve reliable long term operation in demanding high power applications. Please contact Luminus for further information.

Flux Binning Structure^{1,2}

CFT-90-W LED series are production tested and binned at 22.5A DC, 40°C heat sink temperature (90°C nominal junction temperature).

Flux Bins³

Flux Bin	Minumum Flux (lm)	Maximum Flux (lm)
UA	3,680	3,955
UB	3,955	4,230
VA	4,230	4,545
VB	4,545	4,860
WA	4,860	5,225
WB	5,225	5,590
XA	5590	6011
XB	6011	6430

Note 1: Luminus maintains a +/- 6% tolerance on flux measurements.

Note 2: Products are production tested then sorted and packed by bin.

Note 3: Individual bins are not orderable. Please refer to the Product Ordering information page for a list of orderable bin kits.

Chromaticity Bins

Refer to the next page for bin definitions

The following tables describe the four chromaticity points that bound each chromaticity bin.¹

Chromaticity Bins		
Bin Code	x	y
A	0.263	0.285
	0.272	0.296
	0.285	0.272
	0.278	0.264
B	0.272	0.296
	0.282	0.308
	0.293	0.281
	0.285	0.272
C	0.282	0.308
	0.286	0.313
	0.296	0.285
	0.293	0.281
D	0.286	0.313
	0.293	0.320
	0.300	0.298
	0.294	0.292
DEL	0.294	0.292
	0.308	0.307
	0.309	0.302
	0.295	0.288
DEH	0.285	0.317
	0.302	0.336
	0.303	0.331
	0.286	0.313
E	0.293	0.320
	0.303	0.331
	0.308	0.307
	0.300	0.298
F	0.303	0.331
	0.311	0.339
	0.314	0.318
	0.307	0.311
FGH	0.302	0.336
	0.320	0.354
	0.321	0.348
	0.303	0.331

Chromaticity Bins		
Bin Code	x	y
FGL	0.307	0.311
	0.322	0.326
	0.323	0.315
	0.309	0.302
G	0.311	0.339
	0.321	0.348
	0.322	0.326
	0.314	0.318
H	0.321	0.346
	0.329	0.353
	0.329	0.330
	0.322	0.324
HJL	0.322	0.324
	0.337	0.337
	0.336	0.325
	0.323	0.314
HJH	0.320	0.352
	0.338	0.368
	0.338	0.361
	0.321	0.346
J	0.329	0.353
	0.338	0.361
	0.337	0.337
	0.329	0.330
K	0.338	0.361
	0.346	0.368
	0.344	0.342
	0.337	0.337
KH	0.338	0.368
	0.346	0.375
	0.346	0.368
	0.338	0.361

Note 1: Based on production test conditions: 22.5 A DC, 90°C junction temperature.

Note 2: Chromaticity bin code A is defined but not offered in a bin kit.

Ordering Information
CFT — **<XX>** — **W<tc>** — **X11** — **<BinKit>**
Part Numbering Nomenclature

Product Family	LED Emission Area	Color Code	Package Configuration	Bin Kit
C: Chip on board F: Flat-top window-less package T: Single monolithic emitter	90 = 9.0 mm ²	W = White t : Color temperature - D : Daylight - C : Cool White - S : Stage White c: CRI - S = Standard	Internal package code	Refer to ordering codes table in this document

Ordering Part Numbers

Color Point	Code of Minimum Bin	Minimum Flux (lm) ^{1,2}	Chromaticity Bins ¹	Bin Kit	Ordering Part Number
WDS	UA	3,680	H, J, HJH, HJL, K, KH	UA500	CFT-90-WDS-X11-UA500
			H, J, HJH, HJL	UA501	CFT-90-WDS-X11-UA501
			H, J	UA502	CFT-90-WDS-X11-UA502
	UB	3,955	H, J, HJH, HJL, K, KH	UB500	CFT-90-WDS-X11-UB500
			H, J, HJH, HJL	UB501	CFT-90-WDS-X11-UB501
			H, J	UB502	CFT-90-WDS-X11-UB502
	VA	4230	H, J, HJH, HJL, K, KH	VA500	CFT-90-WDS-X11-VA500
			H, J, HJH, HJL	VA501	CFT-90-WDS-X11-VA501
	VB	4545	H, J, HJH, HJL, K, KH	VB500,	CFT-90-WDS-X11-VB500
WCS	UA	3,680	D, E, F, G, DEH, DEL, FGH, FGL	UA600	CFT-90-WCS-X11-UA600
			F, G, FGH, FGL	UA601	CFT-90-WCS-X11-UA601
	UB	3,955	D, E, F, G, DEH, DEL, FGH, FGL	UB600	CFT-90-WCS-X11-UB600
			F, G, FGH, FGL	UB601	CFT-90-WCS-X11-UB601
	VA	4230	D, E, F, G, DEH, DEL, FGH, FGL	VA600	CFT-90-WCS-X11-VA600
			F, G, FGH, FGL	VA601	CFT-90-WCS-X11-VA601
	VB	4545	D, E, F, G, DEH, DEL, FGH, FGL	VB600	CFT-90-WCS-X11-VB600
	WSS	UA	3,680	B, C, D	UA900
C, D, E, DEH, DEL				UA700	CFT-90-WSS-X11-UA700
D, E, DEH, DEL				UA701	CFT-90-WSS-X11-UA701
UB		3,955	B, C, D	UB900	CFT-90-WSS-X11-UB900
			C, D, E, DEH, DEL	UB700	CFT-90-WSS-X11-UB700
			D, E, DEH, DEL	UB701	CFT-90-WSS-X11-UB701
VA		4230	C, D, E, DEH, DEL	VA700	CFT-90-WSS-X11-VA700
			D, E, DEH, DEL	VA701	CFT-90-WSS-X11-VA701
VB		4545	C, D, E, DEH, DEL	VB700	CFT-90-WSS-X11-VB700

Note 1: Based on production test conditions : 22.5 A DC, 90°C junction temperature.

Note 2: The minimum flux of each bin kit is determined by the minimum flux bin. Higher flux bins are eligible to ship against shown bin kits and part numbers.

Product Characteristics and Ratings

Product Characteristics

Unless specified otherwise, all characteristics are based on nominal $T_j = 90^\circ\text{C}$, $I_f = 22.5\text{ A DC}$.

Parameter	Symbol		Value			Unit
			WSS	WCS	WDS	
Emitting Area Dimension ¹	A_e	typ	3 x 3	3 x 3	3 x 3	mm x mm
Luminous Flux	Φ_v	typ	4750	4775	4800	lumens
Radiometric flux	Φ_e	typ	15.1	15.4	15.7	watts
Viewing angle (50% of peak flux)	$2\ \varnothing_{1/2}$	typ	120	120	120	degrees
Forward Voltage	V_F	min	2.9	2.9	2.9	V
		typ	3.5	3.5	3.5	V
		max	4.2	4.2	4.2	V
Color Rendering Index	CRI	typ	70	70	65	

Note 1: Please refer to mechanical drawing for dimensions and tolerancing.

Absolute Maximum Ratings

Parameter	Symbol	Value	Unit
Maximum Current (CW) ¹	I_F	27	A
Minimum Current (CW) ²	I_F	0.2	A
Maximum surge Current ($t < 10\text{ ms}$, Duty cycle < 0.1)	I_S	36	A
Maximum reverse Current ³	I_R	N/A	A
Maximum Junction operating temperature ⁴	T_j	150	$^\circ\text{C}$
Storage Temperature range		-40 to 130	$^\circ\text{C}$
Operating Temperature range		-40 to 85	$^\circ\text{C}$

Note 1: Sustained operation at maximum current will result in shortened lifetime.

Note 2: Special design considerations must be observed for operation at low current density. Please contact Luminus for further information.

Note 3: Not designed for reverse current operation.

Note 4: Sustained operation at maximum operating T_j will result in shortened lifetime and may cause premature product failure.

Relative Luminous Flux vs. I_f
 $\phi_v/\phi_v(22.5A), DC - T_{Heatsink} = 40^\circ C$

Relative Luminous Flux vs. T_j
 $\phi_v/\phi_v(90^\circ C) I_f = 22.5 A DC$

Forward Voltage vs. I_f
 $V_f = f(I_f), DC - T_{Heatsink} = 40^\circ C$

Relative Forward Voltage vs. T_j
 $\Delta V_f = V(T_j) - V(90^\circ C) I_f = 22.5 A DC$

Relative Chromaticity Shift vs. I_f
 $\Delta CIE_{x,y} = CIE_{x,y}(I_f) - CIE_{x,y}(22.5A) - DC, Heatsink Temperature: 40^\circ C$

Relative Chromaticity Shift vs. T_j
 $\Delta CIE_{x,y} = CIE_{x,y}(T_j) - CIE_{x,y}(90^\circ C) I_f = 22.5 A DC$

Optical and Thermal Characteristics

Typical Spectrum

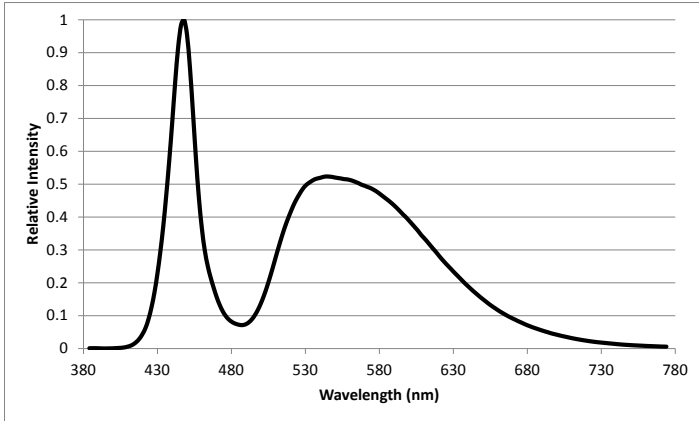

Typical Angular Distribution



Color Over Angle



Thermal Information

Rth [j-c], Electrical	0.45 °C/W
Rth [j-ref], Electrical	0.5 °C/W



Electrical Pinout

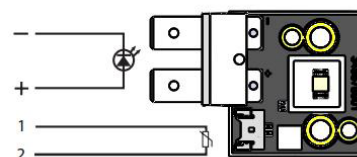

The thermistor used in CFT-90 LEDs mounted on core-boards is from Murata Manufacturing Co. The global part number is NCP18XH103J03RB. Please see <http://www.murata.com/> for details on calculating thermistor temperature.

Important notice: please note that the CFT-90-W copper PCB is electrically active with a common cathode polarity

Mechanical Dimensions^{1,2}

DIMENSIONS IN MILLIMETERS



DIMENSION NAME	DESCRIPTION	NOMINAL DIMENSION	TOLERANCE
"A"	TOP OF METAL SUBSTRATE TO TOP OF FRAME	.55	±.08
"B"	TOP OF EMITTING AREA TO TOP OF FRAME	.14	±.12
"C"	TOP OF METAL SUBSTRATE TO TOP OF EMITTING AREA	.41	±.04

Note 1: Recommended connector for Anode and Cathode: Panduit Disco Lok™ Series P/N: DNG14-250FL-C.
 Thermistor connector on Luminus coreboard: MOLEX P/N 53780-0270 (alternate: GCT P/N WTBO8-021S-F).
 Recommended female thermistor connector: MOLEX P/N 51146-0200 (alternate: GCT P/N WTBO6-021S or equivalent).
 For detailed drawing please refer to document DWG-002705.

Note 2: Some discoloration on the back of the coreboard is possible and is an expected consequence of the assembly process. The discoloration does not affect the thermal properties or reliability of the product.

Note 3: Due to the nature of the manufacturing process used for this product, the phosphor element may exhibit localized cosmetic edge irregularities of up to 100 um compared to nominal drawings.

Shipping Tray Outline

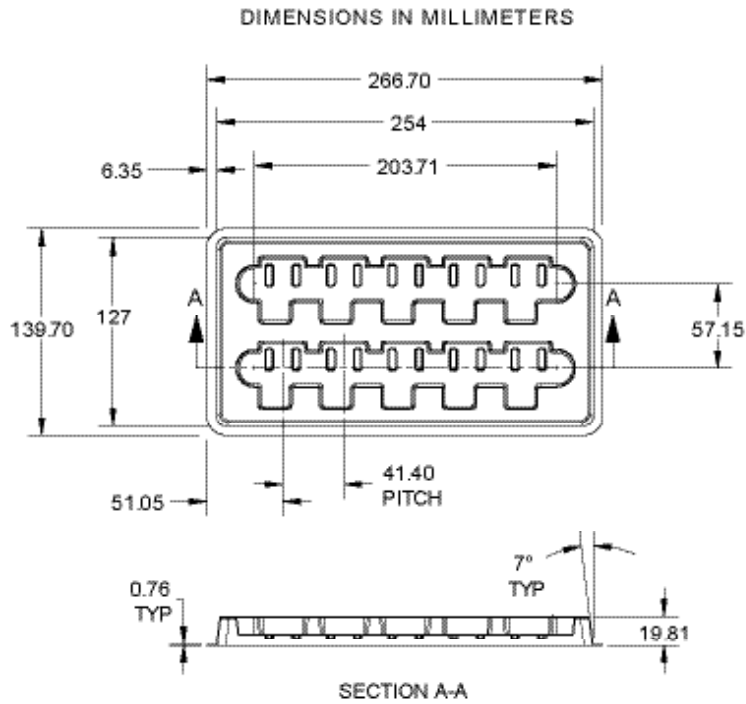

For detailed drawing of shipping trays, please refer to document TO-0479, available upon request.

Packing and Shipping Specification

Packing Specification

Packing Configuration	Qty /Pack	Dimensions (mm)	Gross Weight (kg)
Stack of 5 trays with 10 devices per tray Each pack is enclosed in ESD bag	50	150 x 280 x 85	2.7

Product Label Specification

Label Fields (subject to change):

- 6-8 digit Box number (for Luminus internal use)
- Luminus ordering part number
- Quantity of devices in pack
- Part number revision (for Luminus internal use)
- Customer's part number (optional)
- Bin (FF-WW) as defined page 3
- 2D Bar code



Sample label –for illustration only



Shipping Box

Shipping Box	Quantity	Material	Dimensions (L x W x H, mm)
Carton Box	1 -20 packs (50 - 1000 Devices)	S4651	560 x 560 x 200



History Of Changes

Revision	Date	Description
PDS-002888 Rev 01	01/18/2017	Initial release.
PDS-002888 Rev 02	06/14/2017	Remove preliminary. Add B chromaticity bin and eliminated TB flux bin. Updated ordering bin kits
PDS-002888 Rev 03	07/07/2017	Add comment on mechanical drawing page.

The products, their specifications and other information appearing in this document are subject to change by Luminus Devices without notice. Luminus Devices assumes no liability for errors that may appear in this document, and no liability otherwise arising from the application or use of the product or information contained herein. None of the information provided herein should be considered to be a representation of the fitness or suitability of the product for any particular application or as any other form of warranty. Luminus Devices' product warranties are limited to only such warranties as accompany a purchase contract or purchase order for such products. Nothing herein is to be construed as constituting an additional warranty. No information contained in this publication may be considered as a waiver by Luminus Devices of any intellectual property rights that Luminus Devices may have in such information. This product is protected by U.S. Patents 6,831,302; 7,074,631; 7,083,993; 7,084,434; 7,098,589; 7,105,861; 7,138,666; 7,166,870; 7,166,871; 7,170,100; 7,196,354; 7,211,831; 7,262,550; 7,274,043; 7,301,271; 7,341,880; 7,344,903; 7,345,416; 7,348,603; 7,388,233; 7,391,059 Patents Pending in the U.S. and other countries.