

General Description

The TQP7M9102 is a high linearity driver amplifier in a low-cost, RoHS compliant, surface mount package. This InGaP/GaAs HBT delivers high performance across a broad range of frequencies with +44 dBm OIP3 and +27.5 dBm P1dB while only consuming 135 mA quiescent current. All devices are 100% RF and DC tested.

The TQP7M9102 incorporates on-chip features that differentiate it from other products in the market. The amplifier integrates an on-chip DC over-voltage and RF over-drive protection. This protects the amplifier from electrical DC voltage surges and high input RF input power levels that may occur in a system. On-chip ESD protection allows the amplifier to have a very robust Class 2 HBM ESD rating.

The TQP7M9102 is targeted for use as a driver amplifier in wireless infrastructure where high linearity, medium power, and high efficiency are required. The device an excellent candidate for transceiver line cards in current and next generation multi-carrier 3G / 4G base stations.



3 Pin SOT-89 Package

Product Features

- 400 – 4000 MHz
- +27.5 dBm P1dB
- +44 dBm Output IP3
- 17.8 dB Gain at 2140 MHz
- +5 V Single Supply, 135 mA Current
- Internal RF Overdrive Protection
- Internal DC Overvoltage Protection
- On-Chip ESD Protection
- SOT-89 Package

Applications

- Repeaters
- Mobile Infrastructure
- CDMA / WCDMA / LTE
- General Purpose Wireless

Functional Block Diagram

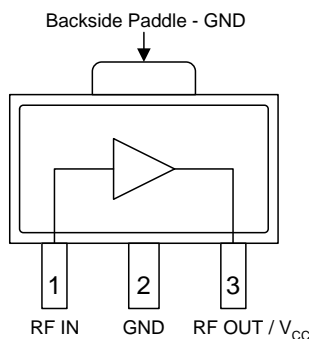

Top View

Ordering Information

Part No.	Description
TQP7M9102	0.5 W High Linearity Amplifier
TQP7M9102-PCB900	869 – 960 MHz Evaluation Board
TQP7M9102-PCB2140	2.11 – 2.17 GHz Evaluation Board
TQP7M9102-PCB2600	2.5 – 2.7 GHz Evaluation Board

Standard T/R size = 1000 pieces on a 7" reel

Absolute Maximum Ratings

Parameter	Rating
Storage Temperature	-65 to 150 °C
RF Input Power, CW, 50Ω, T=25°C	+27 dBm
Device Voltage (V _{CC})	+8 V

Exceeding any one or a combination of the Absolute Maximum Rating conditions may cause permanent damage to the device. Extended application of Absolute Maximum Rating conditions to the device may reduce device reliability.

Recommended Operating Conditions

Parameter	Min	Typ	Max	Units
Device Voltage (V _{CC})	+4.75	+5	+5.25	V
T _{CASE}	-40		+105	°C
T _j for >10 ⁶ hours MTTF			+170	°C

Electrical specifications are measured at specified test conditions. Specifications are not guaranteed over all recommended operating conditions.

Electrical Specifications

Parameter	Conditions ⁽¹⁾	Min	Typ	Max	Units
Operational Frequency Range		400		4000	MHz
Test Frequency			2140		MHz
Gain		15.5	17.8		dB
Input Return Loss			12		dB
Output Return Loss			10		dB
Output P1dB		+26.4	+27.5		dBm
Output IP3	P _{out} = +8 dBm/tone, Δf = 1 MHz	+41	+43.8		dBm
WCDMA Channel Power	-50 dBc ACLR, Note 2		+18.5		dBm
Noise Figure			3.9		dB
Quiescent Current, I _{CCQ}		115	137	155	mA
Thermal Resistance, θ _{JC}	Junction to case			50	°C/W

Notes:

1. Test conditions unless otherwise noted: V_{CC} = +5 V, Temp. = +25 °C, matched 2140 MHz reference circuit
2. ACLR test set-up: 3GPP WCDMA, TM1+64 DPCH, +5 MHz offset, PAR = 10.2 dB at 0.01% Probability

Performance Summary Table

Frequency	635	768	869	960	1540	1840	1960	2140	2140	2350	2600	3500	MHz
Gain	22.4	20.9	21.8	21.7	20.2	20.0	18.4	15.5	17.8	16.0	14.5	14.5	dB
Input Return Loss	12	9	10	17	15	17	13	8	12	17	14.5	17	dB
Output Return Loss	14	8	12	9	6	7.5	7	8	11	8	8	11	dB
Output P1dB	+27.3	+28.4	+27.3	+27.4	+28.2	+27.5	+27.0	+30.7	+27.6	+27.2	+28.0	+26.2	dBm
Output IP3	+44	+44	+43	+44	+51	+42	+46	+38	+44	+44	+44	+45	dBm

Notes:

1. Test conditions unless otherwise noted: V_{CC} = +5 V, Temp. = +25 °C, matched reference circuit
2. Reference designs for the various frequencies are either included on this datasheet or may be obtained by contacting appsupport@qorvo.com

Device Characterization Data

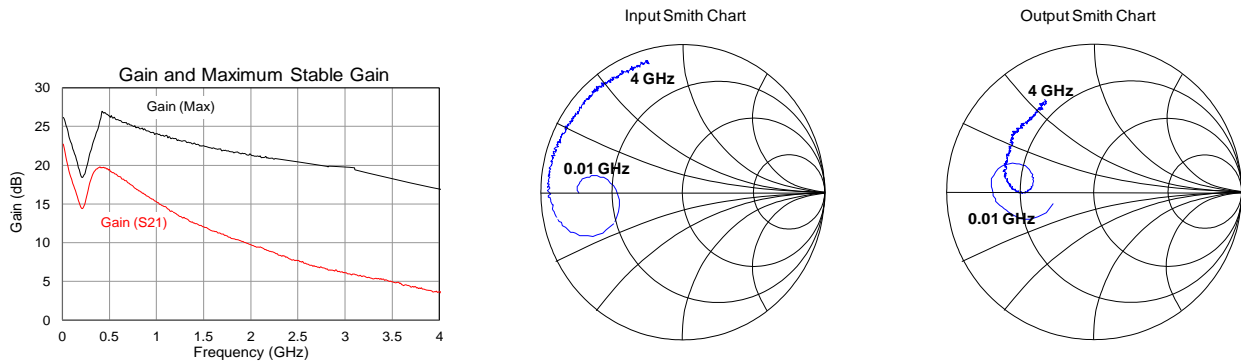

Note: The gain for the unmatched device in a 50 ohm system is shown as the black trace labeled "Gain (S21)". In a circuit tuned for a particular frequency, it is expected that actual gain will be higher, up to the maximum stable gain. The maximum stable gain is shown as the red trace [Gmax]. The impedance Smith chart plots are shown from 0.01 to 4 GHz.

S-Parameters

Freq (MHz)	S11 (dB)	S11 (ang)	S21 (dB)	S21 (ang)	S12 (dB)	S12 (ang)	S22 (dB)	S22 (ang)
50	-2.55	176.64	20.38	156.15	-35.04	-9.37	-5.88	-159.98
100	-2.91	172.21	18.15	151.53	-35.97	-20.12	-4.45	-167.94
200	-5.79	172.18	14.52	160.74	-41.94	-60.14	-3.20	177.62
400	-1.41	-163.37	19.80	154.97	-34.61	49.55	-7.14	165.58
600	-0.52	179.77	18.56	125.67	-33.11	19.10	-6.55	178.58
800	-0.45	171.80	16.85	108.86	-32.96	8.46	-5.41	178.08
1000	-0.49	165.43	15.28	95.36	-32.92	-1.08	-4.76	174.13
1200	-0.60	160.30	13.79	85.52	-33.15	-4.65	-4.38	171.06
1400	-0.60	157.51	12.55	77.70	-33.23	-9.05	-4.24	167.58
1600	-0.67	152.76	11.49	69.57	-33.03	-15.12	-4.15	163.37
1800	-0.74	148.28	10.53	62.39	-32.96	-19.02	-4.00	159.18
2000	-0.72	143.55	9.75	54.69	-33.03	-20.90	-3.89	155.31
2200	-0.78	139.03	8.88	48.56	-32.96	-25.51	-3.77	150.66
2400	-0.71	135.24	7.99	42.25	-32.88	-27.98	-3.40	146.69
2600	-0.74	131.98	7.23	36.47	-33.43	-30.45	-3.38	144.96
2800	-0.75	128.79	6.58	31.19	-33.15	-33.43	-3.44	142.02
3000	-0.80	126.32	6.09	26.41	-33.23	-36.48	-3.50	139.73
3200	-0.75	122.75	5.69	20.73	-33.43	-37.86	-3.39	137.14
3400	-0.81	118.06	5.30	14.38	-33.39	-44.57	-3.48	130.99
3600	-0.82	113.62	4.59	7.77	-33.03	-43.44	-3.34	124.40
3800	-0.71	108.88	4.07	1.73	-32.92	-50.92	-3.04	120.16
4000	-0.68	105.86	3.64	-2.85	-33.15	-54.00	-2.92	118.44

Test Conditions: $V_{CC} = +5\text{ V}$, $I_{CC} = 135\text{ mA}$, Temp. = $+25\text{ }^\circ\text{C}$, unmatched 50 Ohm system, reference plane at device leads

617 – 652 MHz Reference Design

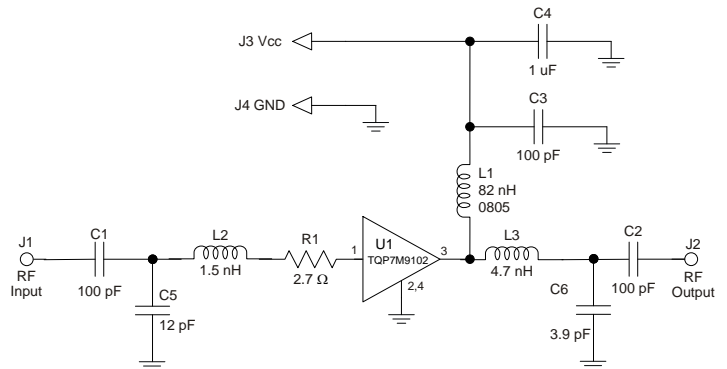
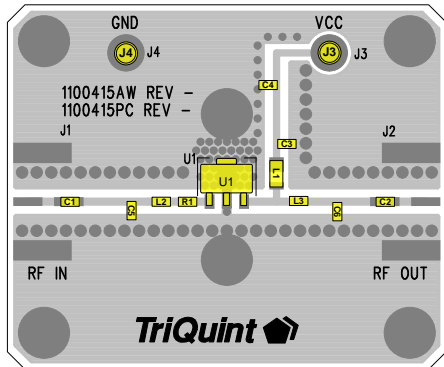

Notes:

1. See Evaluation Board PCB Information for material and stack up.
2. The recommended component values are dependent upon the frequency of operation.
3. All components are of 0603 size unless stated on the schematic.
4. Critical component placement locations:
 - Distance from U1 Pin Pad 1 (left edge) to R1 (right edge): 20 mils
 - Distance from U1 Pin Pad 1 (left edge) to L2 (right edge): 90 mils
 - Distance from U1 Pin Pad 1 (left edge) to C5 (right edge): 235 mils
 - Distance from U1 Pin Pad 3 (right edge) to L3 (left edge): 120 mils
 - Distance from U1 Pin Pad 3 (right edge) to C6 (left edge): 255 mils

Bill of Material 617 – 652 MHz Reference Design

Reference Des.	Value	Description	Manuf.	Part Number
n/a	n/a	Printed Circuit Board	Qorvo	
U1	n/a	½ W High Linearity Amplifier	Qorvo	TQP7M9102
C1 , C2 , C3	100 pF	CAP, 0603, +/-5%. 100V NPO/COG	various	
C5	12 pF	CAP, 0603, +/-2%. 50V. NPO/COG	various	
C6	3.9 pF	CAP, 0603, +/-0.1PF. 100V. NPO/COG	various	
C4	1.0 uF	CAP, 0603, 10%, X5R, 10V	various	
L1	82 nH	IND, 0805, 5%, Ceramic	Coilcraft	0805CS-820XJL
L2	1.5 nH	IND, 0603	various	
L3	4.7 nH	IND, 0603	various	
R1	2.7 Ω	Resistor, Chip, 0603, 5%, 1/16W	various	

Typical Performance 617 – 652 MHz Reference Design

Test conditions unless otherwise noted: $V_{CC}=+5V$, $I_{CO}=137\text{ mA}$ (typ.), Temp.=+25 °C

Parameter	Conditions	Typical Value			Units
Frequency		617	635	652	MHz
Gain		22.3	22.4	22.4	dB
Input Return Loss		10	12	14	dB
Output Return Loss		16	14	12	dB
Output P1dB		+27.1	+27.3	+27.3	dBm
Output IP3	Pout= +15 dBm/tone, Δf= 1 MHz	+43.0	+43.8	+43.7	dBm
LTE Chan. Power ⁽¹⁾	-50 dBc ACLR	+15.8	+16.3	+16.5	dBm

Notes:

1. ACLR test set-up: 1 CH, 20 MHz BW, LTE E-TM1.1, 9.5 dB PAR at 0.01% Probability

Performance Plots 617 – 652 MHz Reference Design

Test conditions unless otherwise noted: $V_{CC}=+5V$, $I_{CQ}=137\text{ mA}$ (typ.)

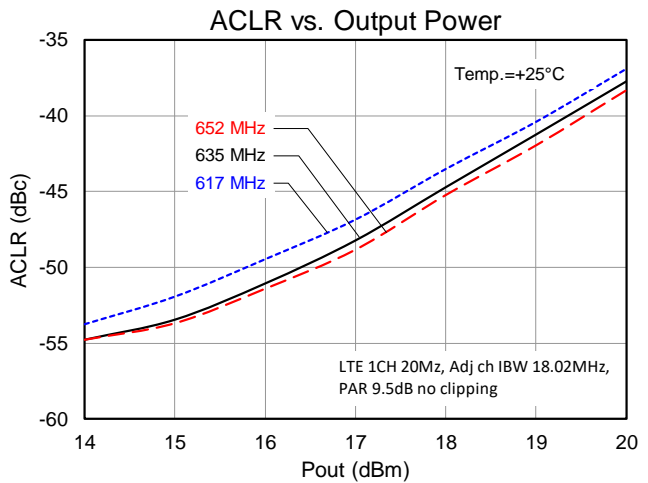
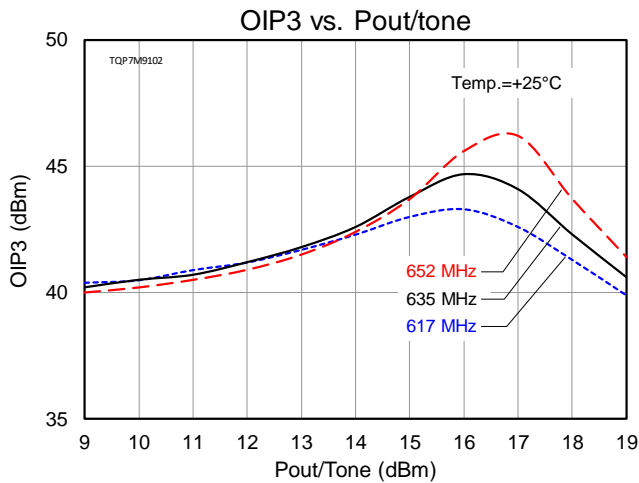
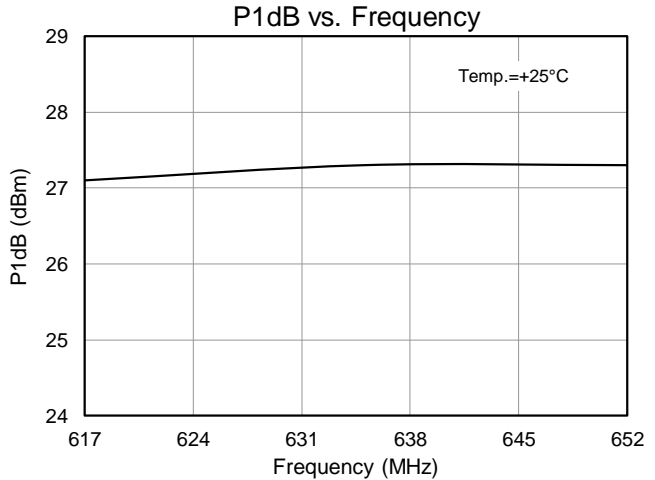
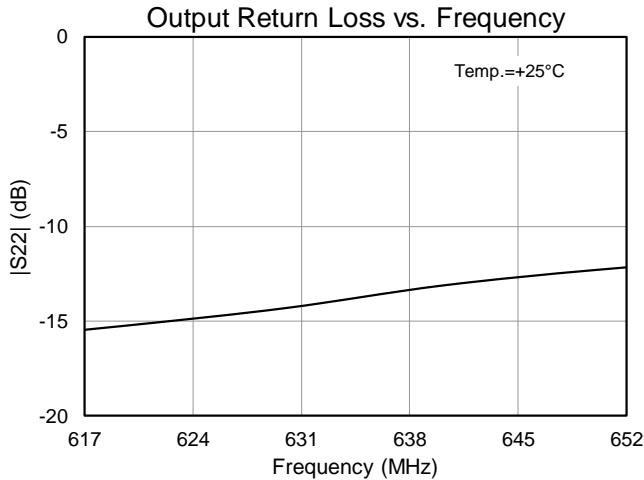
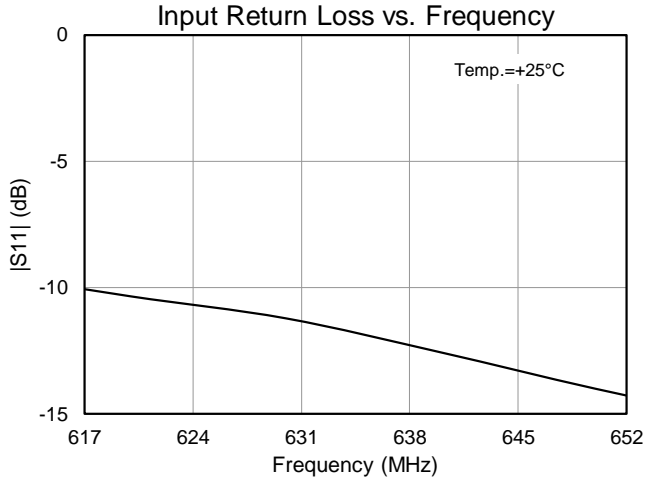
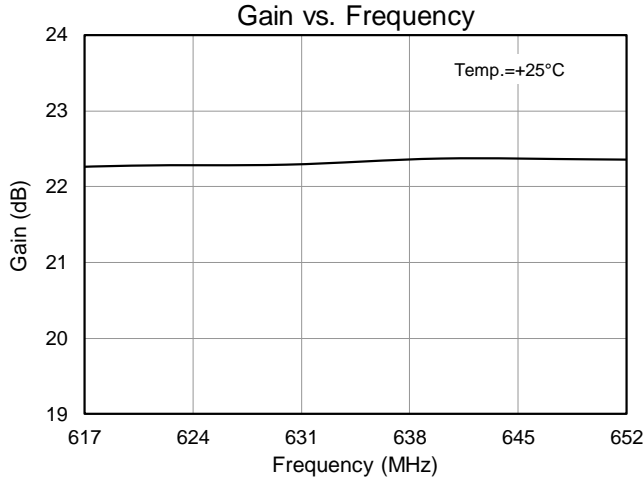

746 – 768 MHz Reference Design

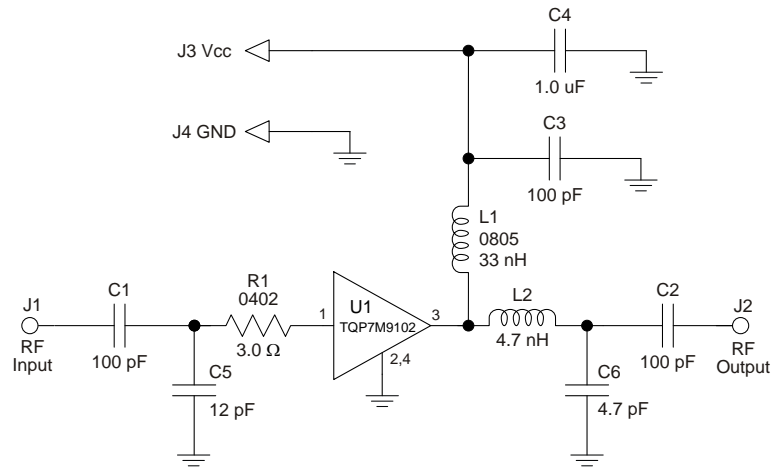
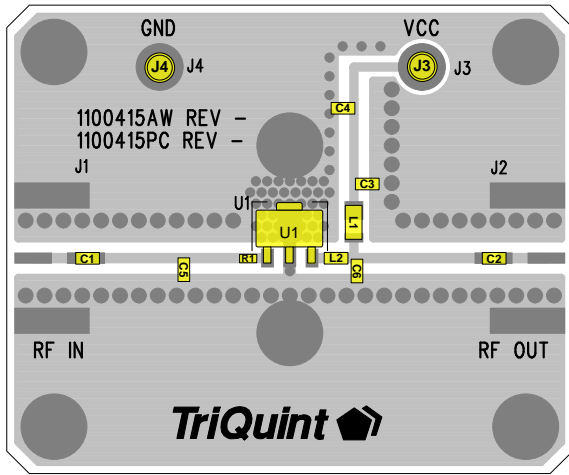

Notes:

5. See Evaluation Board PCB Information for material and stack up.
6. The recommended component values are dependent upon the frequency of operation.
7. All components are of 0603 size unless stated on the schematic.
8. Critical component placement locations:
 - Distance from U1 Pin Pad 1 (left edge) to R1 (right edge): 0 mils
 - Distance from U1 Pin Pad 1 (left edge) to C6 (right edge): 60 mils
 - Distance from U1 Pin Pad 1 (left edge) to C5 (right edge): 230 mils
 - Distance from U1 Pin Pad 3 (right edge) to L2 (left edge): 0 mils

Bill of Material 746 – 768 MHz Reference Design

Reference Des.	Value	Description	Manuf.	Part Number
n/a	n/a	Printed Circuit Board	Qorvo	
U1	n/a	½ W High Linearity Amplifier	Qorvo	TQP7M9102
C1, C2, C3	100 pF	CAP, 0603, +/-5%. 100V NPO/COG	various	
C5	12 pF	CAP, 0603, +/-2%. 50V. NPO/COG	various	
C6	4.7 pF	CAP, 0603, +/-0.1PF. 100V. NPO/COG	various	
C4	1.0 uF	CAP, 0603, 10%, X5R , 10V	various	
L1	33 nH	IND, 0805, 5%, Ceramic	Coilcraft	0805CS-330XJL
L2	4.7 nH	IND, 0603, +/-0.3. >5600MHZ	Toko	LL1608-FSL4N7S
R1	3.0 Ω	Resistor, Chip, 0603, 5%, 1/16W	various	

Typical Performance 746 – 768 MHz Reference Design

Test conditions unless otherwise noted: $V_{CC}=+5V$, $I_{CO}=137mA$ (typ.), Temp.=+25 °C

Parameter	Conditions	Typical Value		Units
Frequency		746	768	MHz
Gain		20.9	20.9	dB
Input Return Loss		8	9	dB
Output Return Loss		10	8	dB
Output P1dB		+28.2	+28.4	dBm
Output IP3	Pout= +18 dBm/tone, Δf= 1 MHz	+47	+44	dBm

Performance Plots 746 – 768 MHz Reference Design

Test conditions unless otherwise noted: $V_{CC}=+5V$, $I_{CQ}=137\text{ mA}$ (typ.)

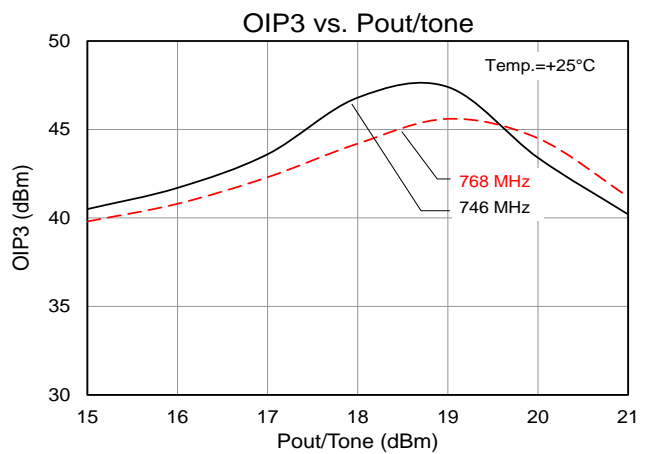
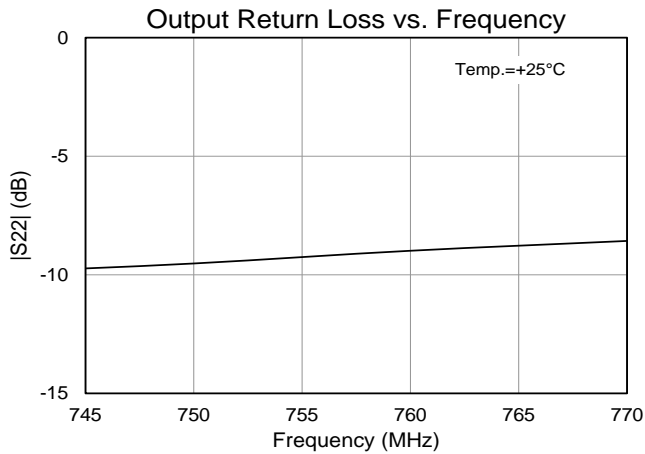
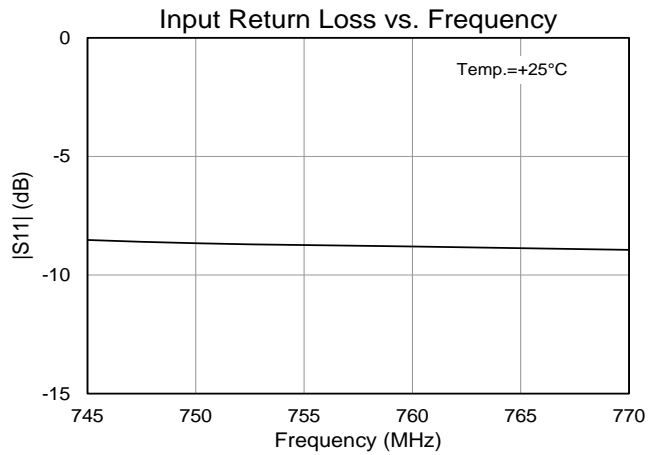
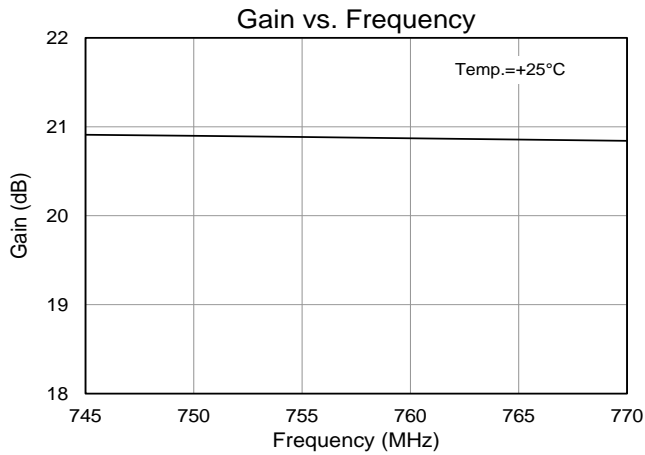

869 – 960 MHz Evaluation Board (TQP7M9102-PCB900)

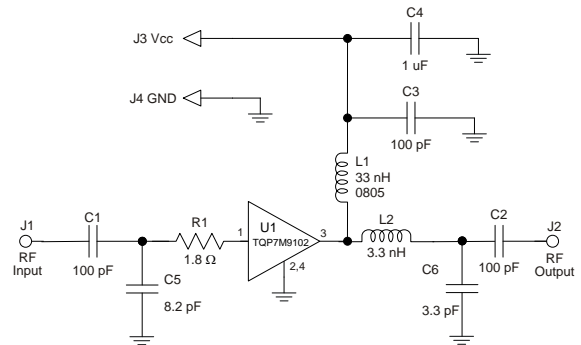
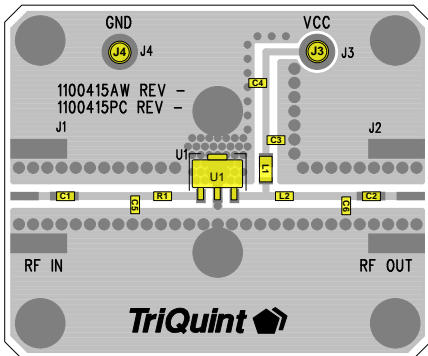

Notes:

1. See Evaluation Board PCB Information for material and stack up.
2. Components shown on the silkscreen but not on the schematic are not used.
3. The recommended component values are dependent upon the frequency of operation.
4. All components are of 0603 size unless stated on the schematic.
5. Critical component placement locations:
 - Distance from U1 Pin 1 (left edge) to R1 (right edge): 90 mils (4.3 deg. at 920 MHz)
 - Distance from R1 (left edge) to C5 (right edge): 70 mils (3.3 deg. at 920 MHz)
 - Distance from U1 Pin 3 (right edge) to L2 (left edge): 120 mils (5.7 deg. at 920 MHz)
 - Distance from U1 Pin 3 (right edge) to C6 (left edge): 370 mils (17.6 deg. at 920 MHz)

Bill of Material TQP7M9102-PCB900

Reference Des.	Value	Description	Manuf.	Part Number
n/a	n/a	Printed Circuit Board	Qorvo	
U1	n/a	TQP7M9102 Amplifier, SOT-89 pkg.	Qorvo	TQP7M9102
R1	1.8 Ω	Resistor, Chip, 0603, 5%, 1/16W	various	
L2	3.3 nH	Inductor, 0603, +/-0.3 nH	Toko	LL1608-FSL3N3S
L1	33 nH	Inductor, 0805, 5%, Coilcraft CS Series	Coilcraft	0805CS-330XJLB
C5	8.2 pF	Cap., Chip, 0603, +/-0.1pF. 200V.	AVX	06032U8R2BAT2A
C6	3.3 pF	Cap., Chip, 0603, +/-0.1pF. 200V.	AVX	06032U3R3BAT2A
C1, C2, C3	100 pF	Cap., Chip, 5%, 50V, NPO/COG	various	
C4	1.0 uF	Cap., Chip, 10%, 10V, X5R	various	

Typical Performance TQP7M9102-PCB900

Test conditions unless otherwise noted: $V_{CC}=+5V$, $I_{CQ}=137\text{ mA}$ (typ.), $Temp.=+25\text{ }^{\circ}\text{C}$

Parameter	Conditions	Typical Value			Units
Frequency		869	920	960	MHz
Gain		21.8	21.9	21.7	dB
Input Return Loss		10	16	17	dB
Output Return Loss		12	10	9	dB
Output P1dB		+27.3	+27.4	+27.4	dBm
OIP3	$P_{out}= +19\text{ dBm/ tone, } \Delta f=1\text{ MHz}$	+42.7	+43.4	+43.9	dBm
WCDMA Channel Power ⁽¹⁾	-50 dBc ACLR	+18.0	+18.2	+18.1	dBm
Noise Figure		5.9	5.9	5.9	dB

Notes:

1. ACLR Test set-up: 3GPP WCDMA, TM1+64 DPCH, +5 MHz offset, PAR = 10.2 dB at 0.01% Probability

Performance Plots TQP7M9102-PCB900

Test conditions unless otherwise noted: $V_{CC}=+5V$, $I_{CQ}=137\text{ mA}$ (typ.)

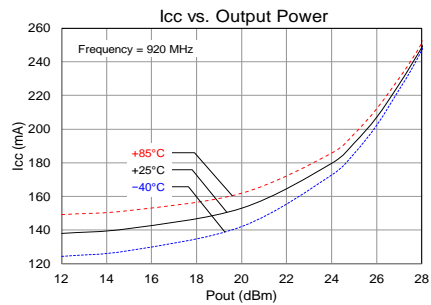
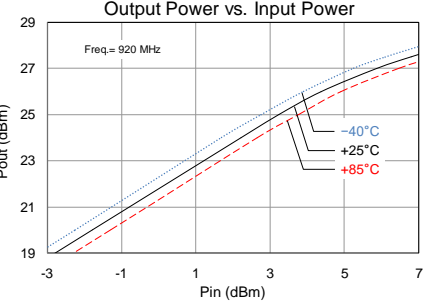
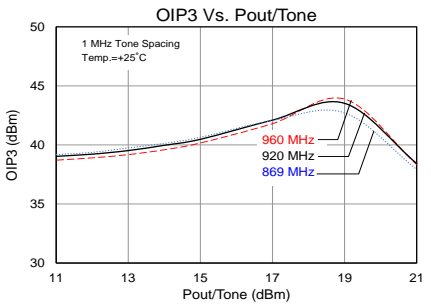
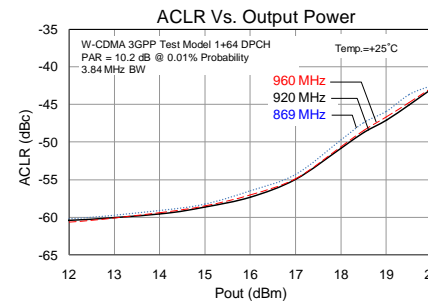
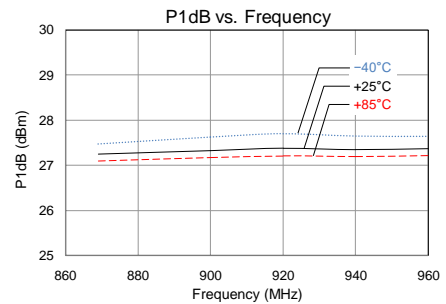
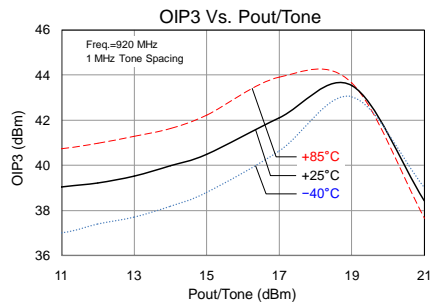
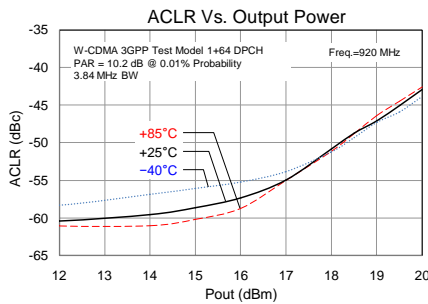
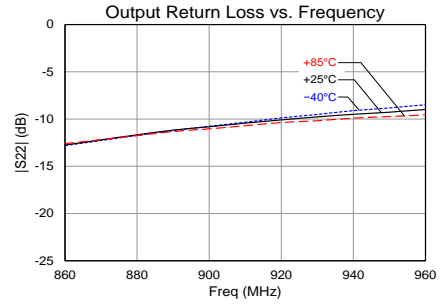
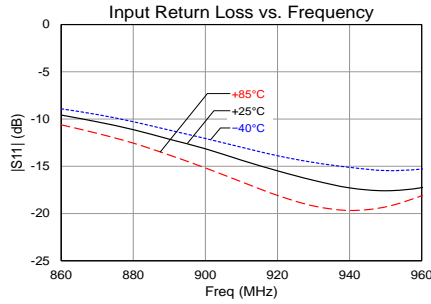
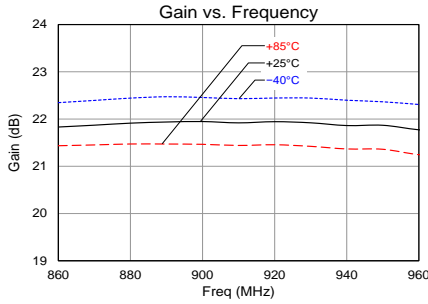

700 – 1000 MHz Reference Design

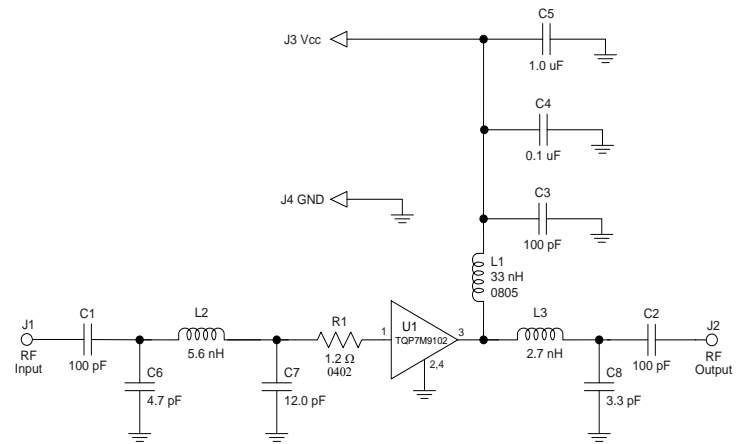
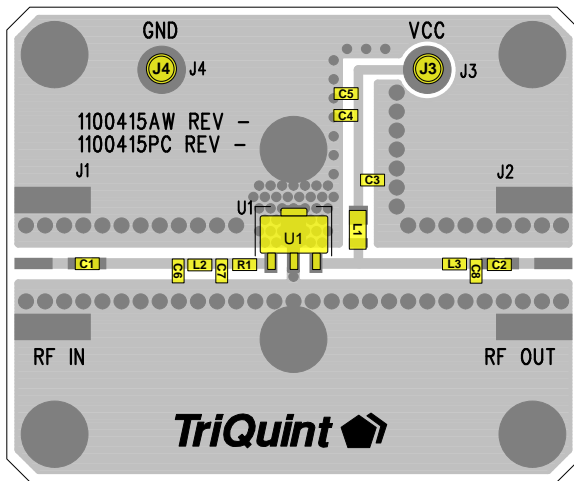

Notes:

1. The recommended component values are dependent upon the frequency of operation.
2. All components are of 0603 size unless stated on the schematic.
3. Entire Bias network values are critical of linearity performance.
4. Critical component placement locations:
 - Distance from U1 Pin 1 (left edge) to R1 (right edge): 10 mils (0.5 deg at 920 MHz)
 - Distance from R1 (left edge) to C7 (right edge): 10 mils (0.5 deg at 920 MHz)
 - Distance from C7 (left edge) to L2 (right edge): 10 mils (0.5 deg at 920 MHz)
 - Distance from L2 (left edge) to C6 (right edge): 20 mils (1.0 deg at 920 MHz)
 - Distance from U1 Pin 3 (right edge) to L3 (left edge): 290 mils (13.8 deg at 920 MHz)
 - Distance from L3 (right edge) to C8 (left edge): 20 mils (1.0 deg at 920 MHz)

Bill of Material 700 – 1000 MHz Reference Design

Reference Des.	Value	Description	Manuf.	Part Number
n/a	n/a	Printed Circuit Board	Qorvo	
U1	n/a	½ W High Linearity Amplifier	Qorvo	TQP7M9102
C1,C2,C3	100 pF	0603, 5%, 50 V, NPO/COG	various	
C4	0.1 μF	0603, 10%, 50 V, X7R	various	
C5	1.0 μF	0603, 10%, 10 V, X5R	Various	LL-1608-FSL1N2S
L1	33 nH	0805, 5%, cer core,0805 Coilcraft	Coilcraft	0805CS-330XJL
L2	5.6 nH	0603, ± 0.3 nH, multilayer, Toko	Toko	LL1608-FSL5N6S
L3	2.7 nH	0603, ± 0.3 nH, multilayer, Toko	Toko	LL1608-FSL2N7S
C6	4.7 pF	0603, ± 0.1 pF, 200 V, NPO/COG, AVX U Series	AVX	06032U4R7BAT2A
C7	12 pF	0603, 2%, 50 V, NPO/COG	Various	
C8	3.3 pF	0603, ± 0.1 pF, 200 V, NPO/COG, AVX U Series	AVX	06032U3R3BAT2A

Typical Performance 700 – 1000 MHz Reference Design

Test conditions unless otherwise noted: $V_{CC}=+5\text{ V}$, $I_{CQ}=135\text{ mA}$, $\text{Temp} = +25\text{ }^{\circ}\text{C}$, $50\ \Omega$ system

Parameter	Conditions	Typical Value			Units
Frequency		700	850	1000	MHz
Gain		22.2	21.8	21.1	dB
Input Return Loss		6.3	7.7	7.2	dB
Output Return Loss		18.8	14.2	15.2	dB
Output P1dB		+27.4	+28	+28.3	dBm
Output IP3	Pout= +16 dBm / tone, $\Delta f= 1\text{ MHz}$	+42.3	+43	+41.3	dBm

Performance Plots 700 – 1000 MHz Reference Design

Test conditions unless otherwise noted: $V_{CC}=+5\text{ V}$, $I_{CQ}=137\text{ mA}$ (typ.), $\text{Temp.}=+25\text{ }^{\circ}\text{C}$

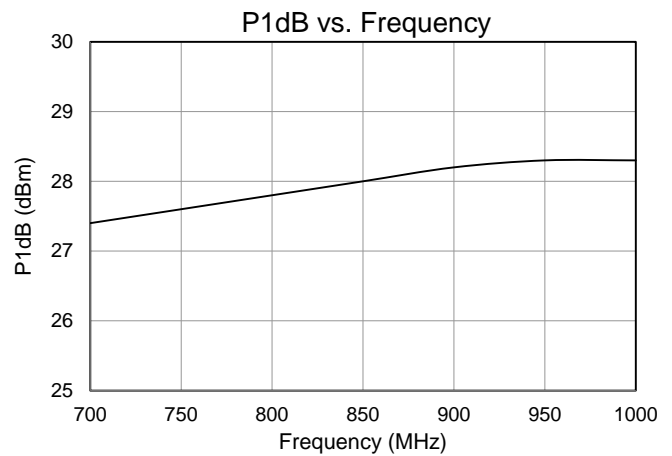
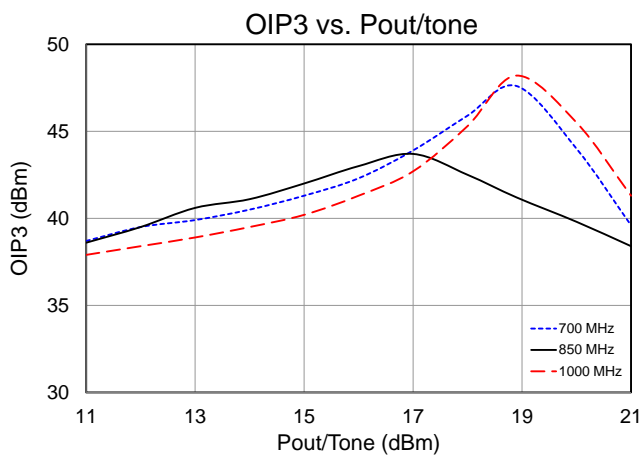
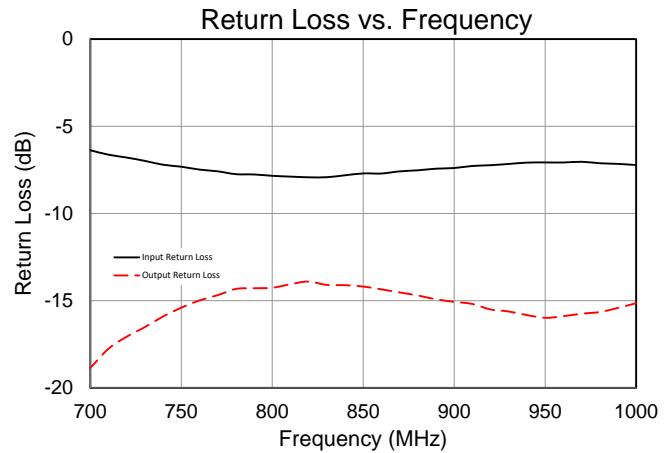
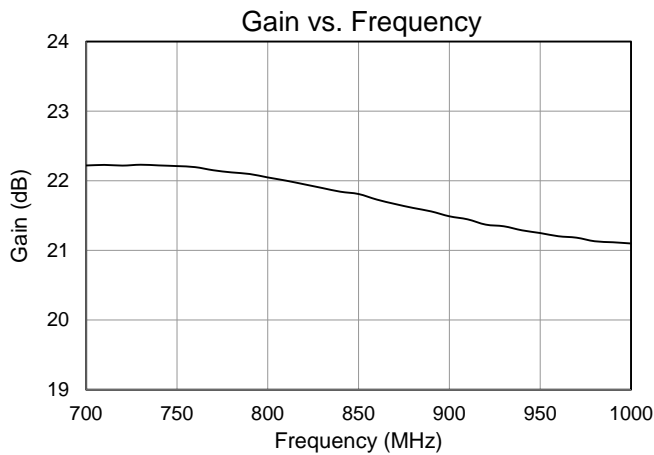

1800 – 2200 MHz 1 Watt Reference Design

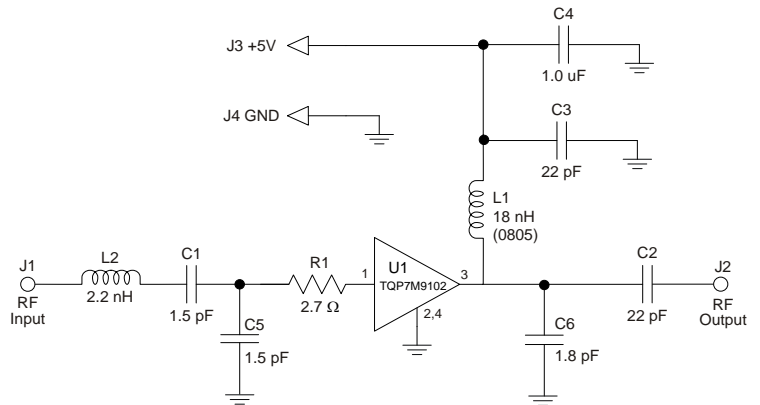
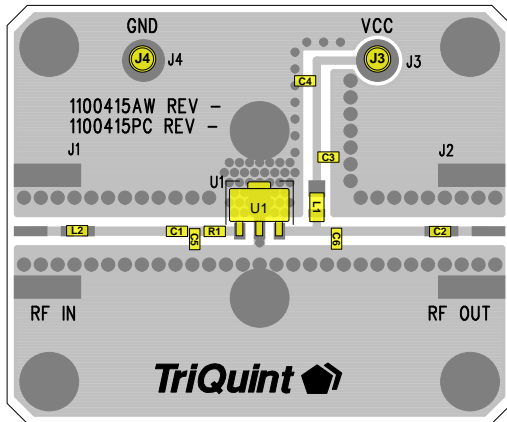

Notes:

1. See Evaluation Board PCB Information for material and stack up.
2. Components shown on the silkscreen but not on the schematic are not used.
3. 0 Ω resistors (R2) may be replaced with copper trace in the target application layout.
4. The recommended component values are dependent upon the frequency of operation.
5. All components are of 0603 size unless stated on the schematic.
6. Critical component placement locations:
 - Distance from U1 Pin 1 (left edge) to R1 (right edge): 25 mils
 - Distance from U1 Pin 1 (left edge) to C1 (right edge): 145 mils
 - Distance from U1 Pin 1 (left edge) to C5 (right edge): 90 mils
 - Distance from U1 Pin 3 (right edge) to C6 (left edge): 145 mils

Bill of Material 1800 – 2200 MHz 1 Watt Reference Design

Reference Des.	Value	Description	Manuf.	Part Number
n/a	n/a	Printed Circuit Board	Qorvo	
U1	n/a	½ W High Linearity Amplifier	Qorvo	TQP7M9102
C2 , C3	22 pF	CAP, 0603, +/-1%. 200V NPO/COG	various	
C1, C5	1.5 pF	CAP, 0603, +/-0.1pF. 200V. NPO/COG	various	
L2	2.2 nH	Ind, chip, 0603, +/-0.3nH >6000MHz	Toko	LL-1608-FSL1N2S
C4	1.0 uF	CAP, 0603, 10%, X5R , 10V	various	
L1	18 nH	IND, 0805, 5%, Ceramic	Coilcraft	0805CS-180XJL
C6	1.8pF	CAP, 0603, +/-0.1pF. 200V. NPO/COG	various	
R1	2.7 Ω	RES, 0603, 5%	various	

Typical Performance 1800 – 2200 MHz 1 Watt Reference Design

Test conditions unless otherwise noted: $V_{CC} = +5V$, $I_{CQ} = 137$ mA (typ.), Temp= +25°C

Parameter	Conditions	Typical Value			Units
		1800	2000	2200	
Frequency		1800	2000	2200	MHz
Gain		15.3	15.5	15.4	dB
Input Return Loss		7.5	8	9	dB
Output Return Loss		7	8	8	dB
Output P1dB		+29.7	+30.7	+29.9	dBm
Output IP3	Pout= +15 dBm/tone, Δf= 1 MHz	+38	+38	+38	dBm

Performance Plots 1800 – 2200 MHz 1 Watt Reference Design

Test conditions unless otherwise noted: $V_{CC}=+5\text{ V}$, $I_{CQ}=137\text{ mA}$ (typ.), $Temp.=+25\text{ }^{\circ}\text{C}$

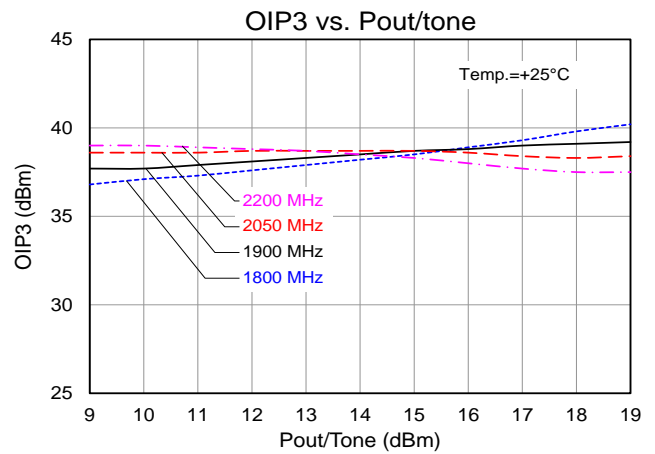
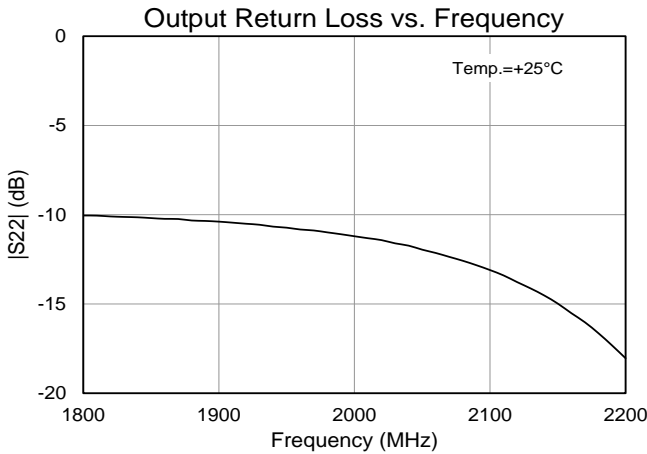
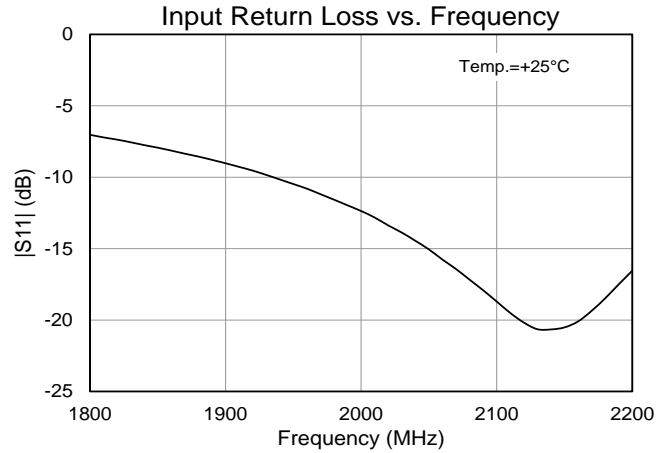
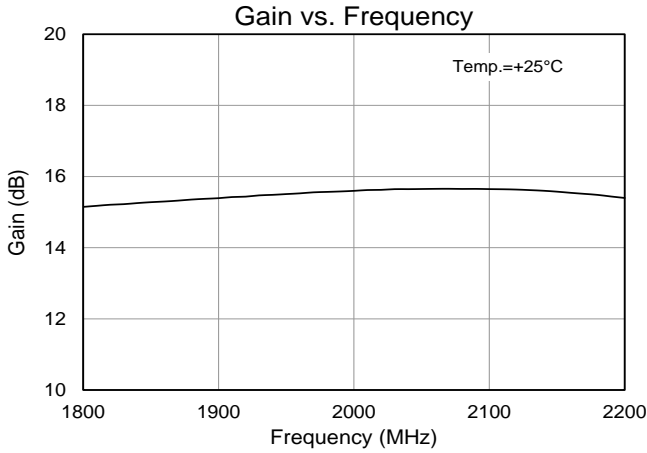

2110 – 2170 MHz Evaluation Board (TQP7M9102-PCB2140)

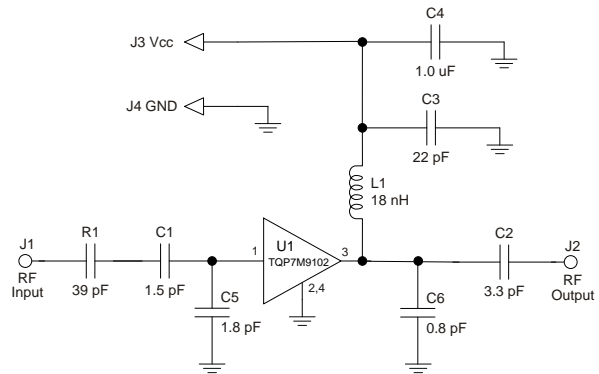
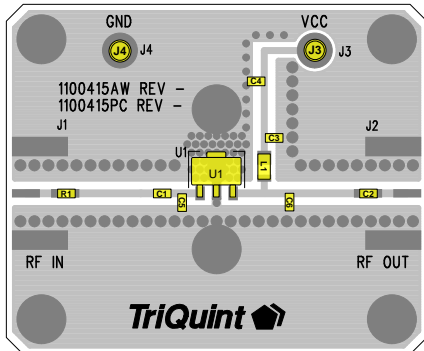

Notes:

1. See Evaluation Board PCB Information for material and stack up.
2. Components shown on the silkscreen but not on the schematic are not used.
3. The recommended component values are dependent upon the frequency of operation.
4. All components are of 0603 size unless stated on the schematic.
5. Critical component placement locations:
 - Distance from U1 Pin 1 (left edge) to C5 (right edge): 35 mils (3.9 deg. at 2140 MHz)
 - Distance from U1 Pin 1 (left edge) to C1 (right edge): 90 mils (9.9 deg. at 2140 MHz)
 - Distance from U1 Pin 3 (right edge) to C6 (left edge): 210 mils (23.2 deg. at 2140 MHz)

Bill of Material TQP7M9102-PCB2140

Reference Des.	Value	Description	Manuf.	Part Number
n/a	n/a	Printed Circuit Board	Qorvo	
U1	n/a	TQP7M9102 Amplifier, SOT-89 pkg.	Qorvo	TQP7M9102
R1	39 pF	Cap., Chip, 0603, +/-1%. 200V NPO/COG	various	
L1	18 nH	Inductor, 0805, Coilcraft CS Series	Coilcraft	0805CS-180XJLB
C1	1.5 pF	Cap., Chip, 0603, +/-0.1pF. 200V. NPO/COG	various	06032U1R5BAT2A
C2	3.3 pF	Cap., Chip, 0603, +/-0.1pF. 200V. NPO/COG	various	06032U3R3BAT2A
C3	22 pF	Cap., Chip, 5%, 50V, NPO/COG	various	
C4	1.0 uF	Cap., Chip, 10%, 10V, X5R	various	
C5	1.8 pF	Cap., Chip, 0603, +/-0.1pF. 200V. NPO/COG	various	06032U1R8BAT2A
C6	0.8 pF	Cap., Chip, 0603, +/-0.05pF, 50V	various	06032U0R8BAT2A

Typical Performance TQP7M9102-PCB2140

Test conditions unless otherwise noted: $V_{CC}=+5V$, $I_{CQ}=137\text{ mA}$ (typ.), $Temp=+25^\circ\text{C}$

Parameter	Conditions	Typical Value			Units
Frequency		2110	2140	2170	MHz
Gain		17.9	17.8	17.7	dB
Input Return Loss		12	12	11	dB
Output Return Loss		12	11	10	dB
Output P1dB		+27.8	+27.6	+27.4	dBm
OIP3	$P_{out}= +9\text{ dBm/ tone}$, $\Delta f=1\text{ MHz}$	+43.6	+43.5	+43.6	dBm
WCDMA Channel Power ⁽¹⁾	-50 dBc ACLR	+18.5	+18.4	+18.3	dBm
Noise Figure		3.8	3.9	4.0	dB

Notes:

1. ACLR Test set-up: 3GPP WCDMA, TM1+64 DPCH, +5 MHz offset, PAR = 10.2 dB at 0.01% Prob

Performance Plots TQP7M9102-PCB2140

Test conditions unless otherwise noted: $V_{CC}=+5\text{ V}$, $I_{CQ}=137\text{ mA}$ (typ.)

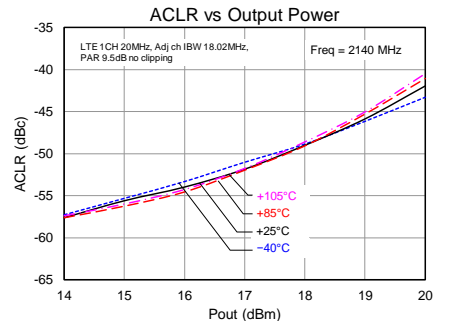
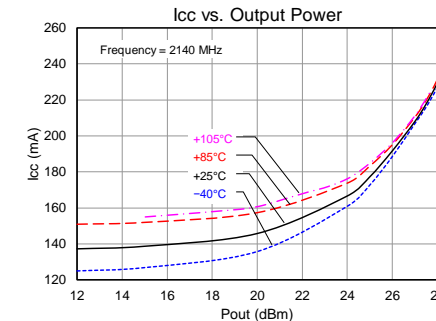
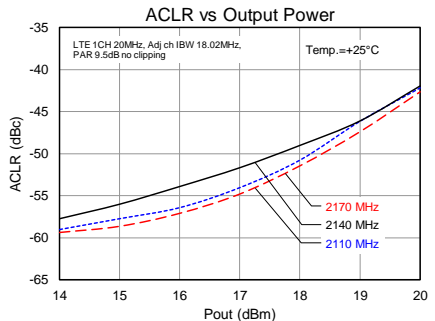
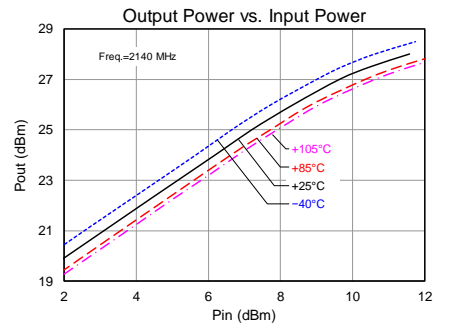
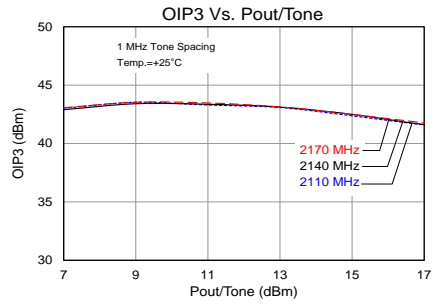
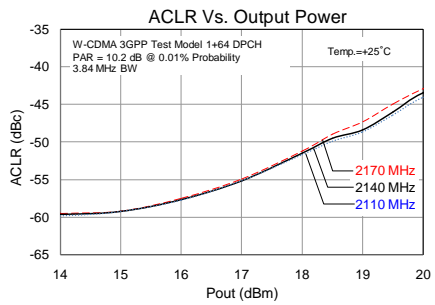
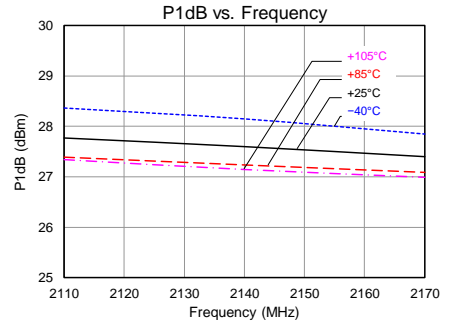
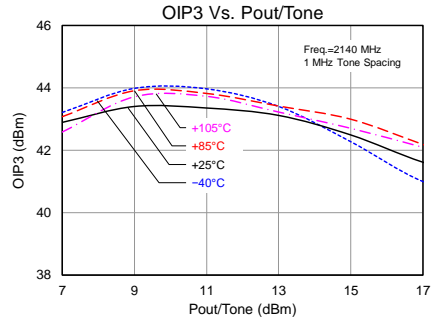
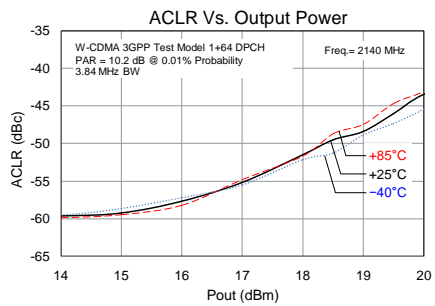
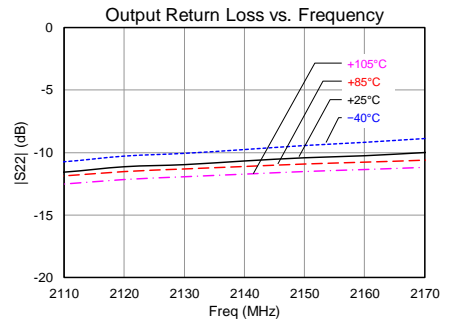
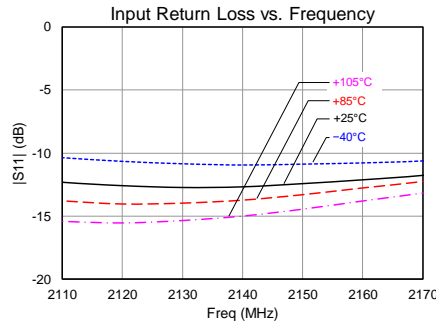
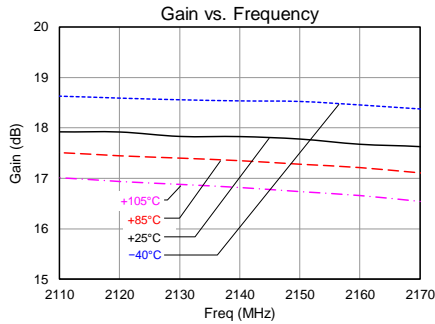

2300 – 2700 MHz Reference Design

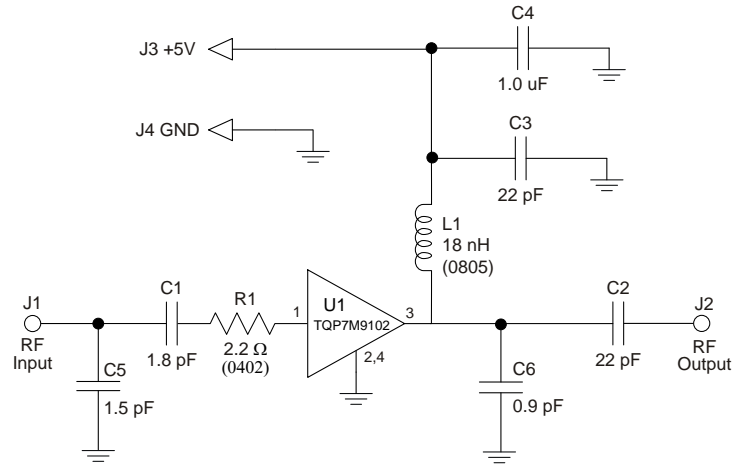
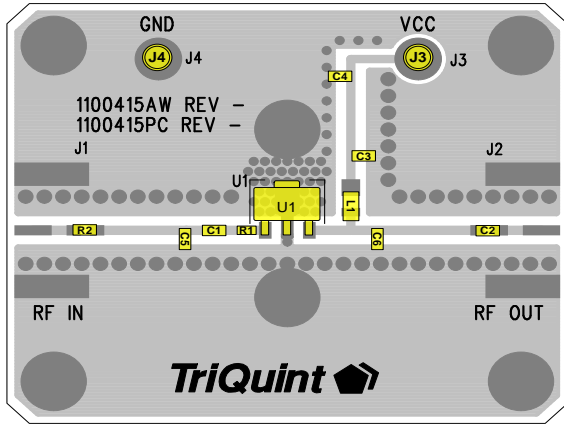

Notes:

1. See Evaluation Board PCB Information for material and stack up.
2. Components shown on the silkscreen but not on the schematic are not used.
3. 0 Ω resistors (R2) may be replaced with copper trace in the target application layout.
4. The recommended component values are dependent upon the frequency of operation.
5. All components are of 0603 size unless stated on the schematic.
6. Critical component placement locations:
 - Distance from U1 Pin 1 (left edge) to R1 (right edge): 10 mils
 - Distance from U1 Pin 1 (left edge) to C1 (right edge): 80 mils
 - Distance from U1 Pin 1 (left edge) to C5 (right edge): 235 mils
 - Distance from U1 Pin 3 (right edge) to C6 (left edge): 165 mils

Bill of Material 2300 – 2700 Reference Design

Reference Des.	Value	Description	Manuf.	Part Number
n/a	n/a	Printed Circuit Board	Qorvo	
U1	n/a	½ W High Linearity Amplifier	Qorvo	TQP7M9102
C1	1.8 pF	CAP, 0603, ± 0.05 pF, 50V, ACCU-P	AVX	06035J1R8ABSTR
C5	1.5 pF	CAP, 0603, ± 0.05 pF, 50V, ACCU-P	AVX	06035J1R5ABSTR
C2, C3	22 pF	CAP, 0603, 5%, 50V, NPO/COG	various	
C4	1.0 uF	CAP, 0603, 10%, X5R, 10V	various	
C6	0.9 pF	CAP, 0603	AVX	06035J0R9ABSTR
R1	2.2 Ω	RES, 0402	various	
R2	0 Ω	RES, 0603, 5%, 1/16W, Chip	various	
L1	18 nH	IND, 0805, 5%, Ceramic	Coilcraft	0805CS-180XJL

Typical Performance 2300 – 2700 Reference Design

Test conditions unless otherwise noted: $V_{CC}=+5\text{ V}$, $I_{CQ}=137\text{ mA}$ (typ.), $Temp.=+25\text{ }^{\circ}\text{C}$

Parameter	Conditions	Typical Value			Units
		2300	2500	2700	
Frequency		2300	2500	2700	MHz
Gain		13.8	14.7	13.6	dB
Input Return Loss		5.5	13.3	7.9	dB
Output Return Loss		12.6	12	10.6	dB
Output P1dB		+27.7	+27.8	+27.1	dBm
OIP3	$P_{out}= +9\text{ dBm / Tone, } \Delta f = 1\text{ MHz}$	+43.8	+44.0	+45.9	dBm

Performance Plots 2300 – 2700 Reference Design

Test conditions unless otherwise noted: $V_{CC}=+5\text{ V}$, $I_{CQ}=137\text{ mA}$ (typ.), $Temp.=+25\text{ }^{\circ}\text{C}$

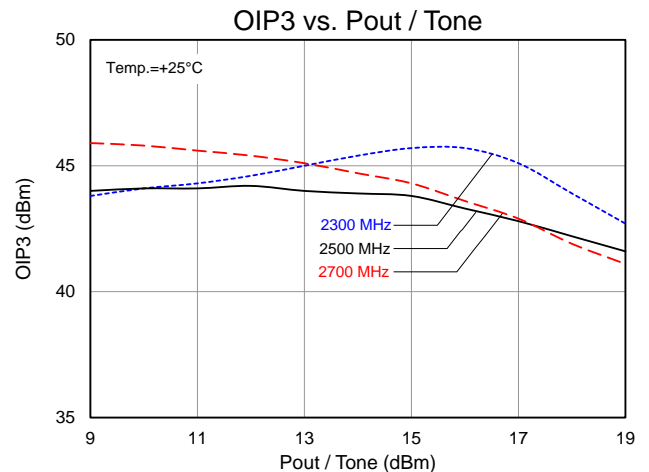
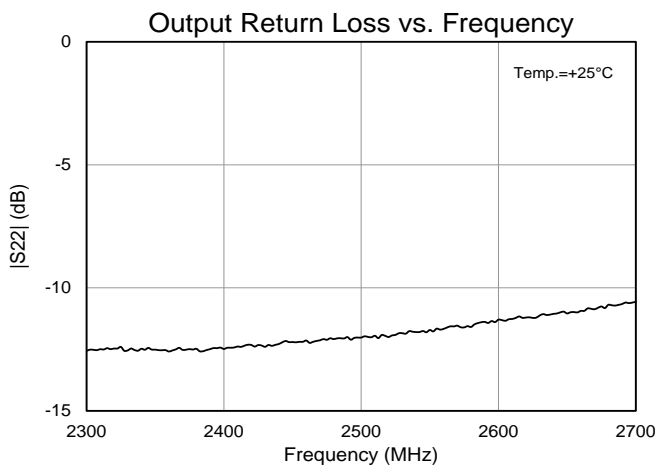
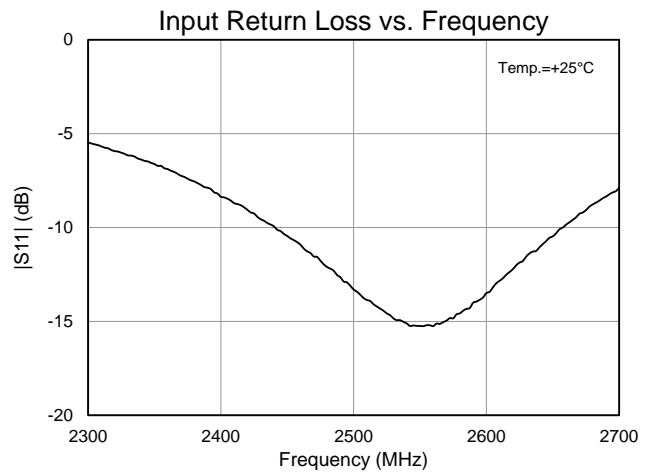
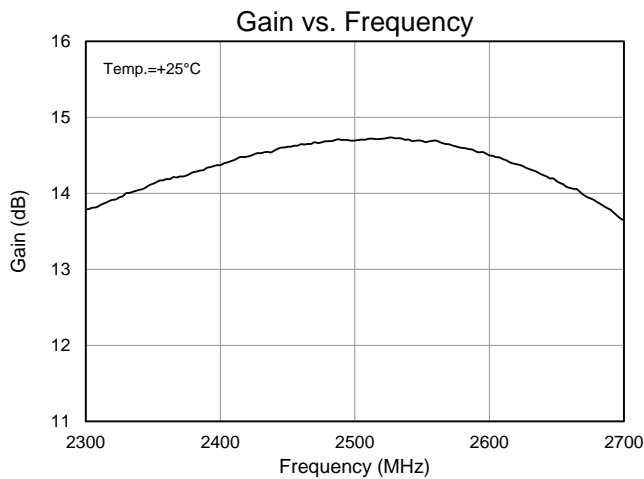

2.5 – 2.7 GHz Evaluation Board (TQP7M9102-PCB2600)

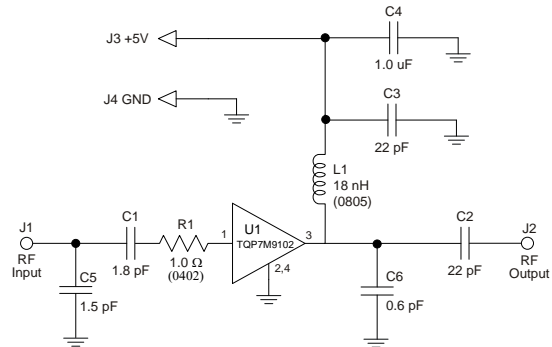
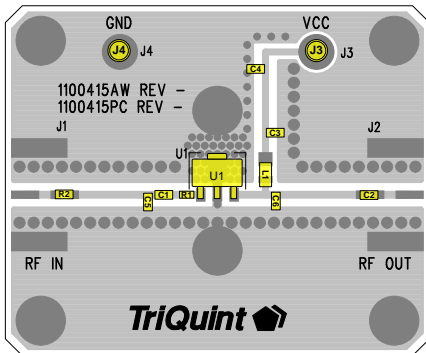

Notes:

1. See Evaluation Board PCB Information for material and stack up.
2. Components shown on the silkscreen but not on the schematic are not used.
3. 0 Ω resistors (R2) may be replaced with copper trace in the target application layout.
4. The recommended component values are dependent upon the frequency of operation.
5. All components are of 0603 size unless stated on the schematic.
6. Critical component placement locations:
 - Distance from U1 Pin 1 (left edge) to R1 (right edge): 13 mils
 - Distance from U1 Pin 1 (left edge) to C1 (right edge): 70 mils
 - Distance from U1 Pin 1 (left edge) to C5 (right edge): 148 mils
 - Distance from U1 Pin 3 (right edge) to C6 (left edge): 78 mils

Bill of Material TQP7M9102-PCB2600

Reference Des.	Value	Description	Manuf.	Part Number
n/a	n/a	Printed Circuit Board	Qorvo	
U1	n/a	½ W High Linearity Amplifier	Qorvo	TQP7M9102
C1	1.8 pF	CAP, 0603, ± 0.05 pF, 50V, ACCU-P	AVX	06035J1R8ABSTR
C5	1.5 pF	CAP, 0603, ± 0.05 pF, 50V, ACCU-P	AVX	06035J1R5ABSTR
C2, C3	22 pF	CAP, 0603, 5%, 50V, NPO/COG	various	
C4	1.0 uF	CAP, 0603, 10%, X5R, 10V	various	
C6	0.6 pF	CAP, 0603, ± 0.05 pF, 50V, ACCU-P	AVX	06035J0R6ABSTR
R1	1.0 Ω	RES, 0402, 1%, 1/16W. CHIP.	various	
R2	0 Ω	RES, 0603, 5%, 1/16W, Chip	various	
L1	18 nH	IND, 0805, 5%, Ceramic	Coilcraft	0805CS-180XJL

Typical Performance TQP7M9102-PCB2600

Test conditions unless otherwise noted: $V_{CC}=+5\text{ V}$, $I_{CQ}=137\text{ mA}$ (typ.), Temp.=+25 °C

Parameter	Conditions	Typical Value			Units
Frequency		2500	2600	2700	MHz
Gain		14.3	14.5	14.1	dB
Input Return Loss		8.5	14.5	12	dB
Output Return Loss		8.5	8	7.5	dB
Output P1dB		+28.0	+28.0	+28.0	dBm
OIP3	Pout= +11 dBm/tone, Δf=1 MHz	+44.0	+43.7	+43.0	dBm
WCDMA Channel Power ⁽¹⁾	-50 dBc ACLR	+17.5	+17.5	+17.5	dBm

Notes:

1. ACLR Test set-up: 3GPP WCDMA, TM1+64 DPCH, +5 MHz offset, PAR = 10.2 dB at 0.01% Prob.

Performance Plots TQP7M9102-PCB2600

Test conditions unless otherwise noted: $V_{CC}=+5\text{ V}$, $I_{CQ}=137\text{ mA}$ (typ.), Temp.=+25 °C

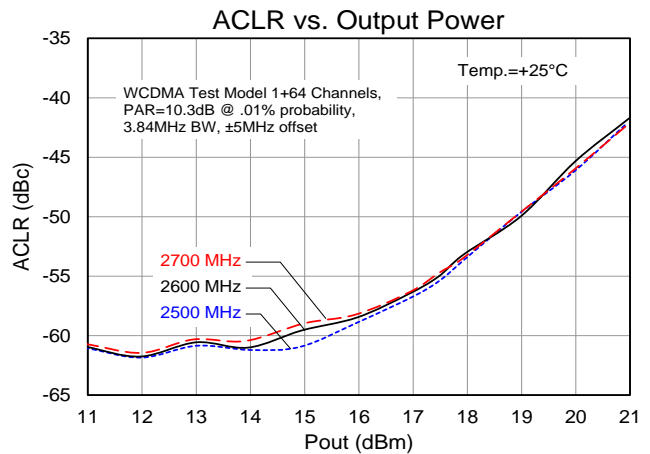
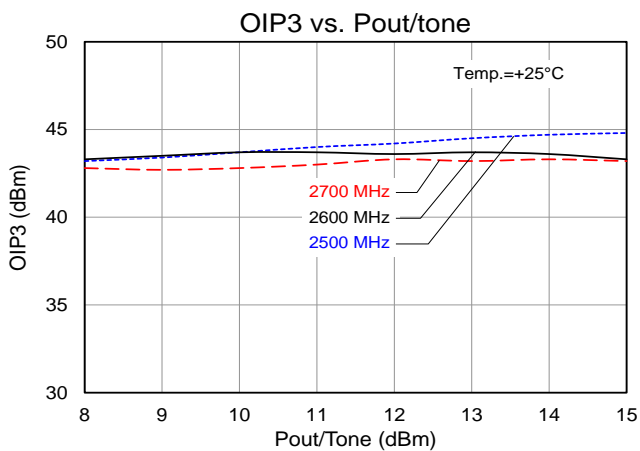
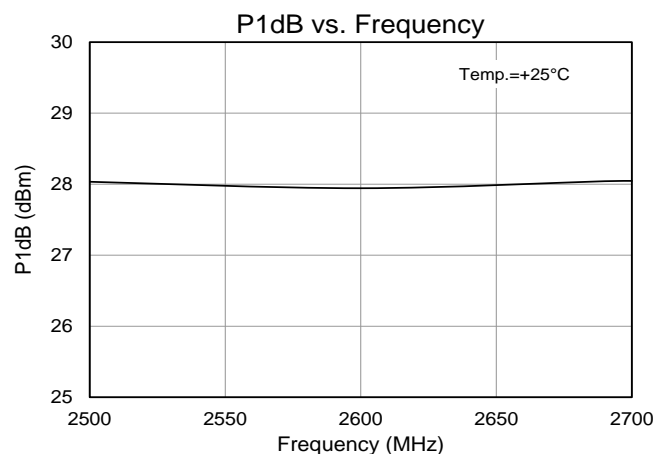
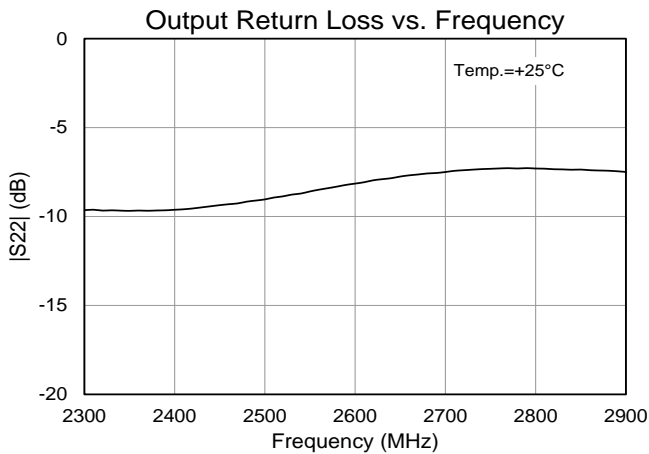
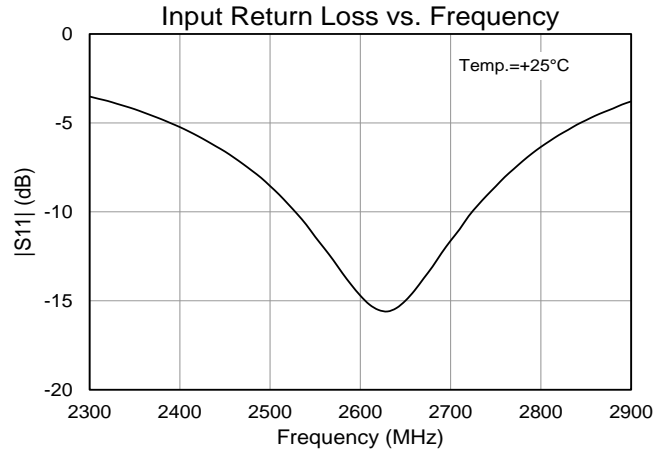
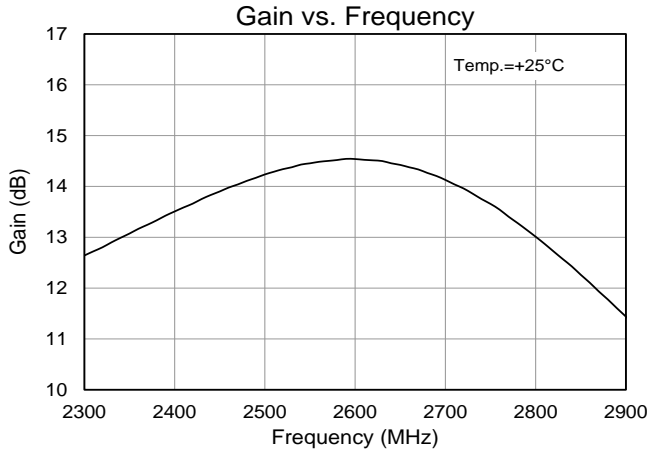

3400 – 3600 MHz Reference Design

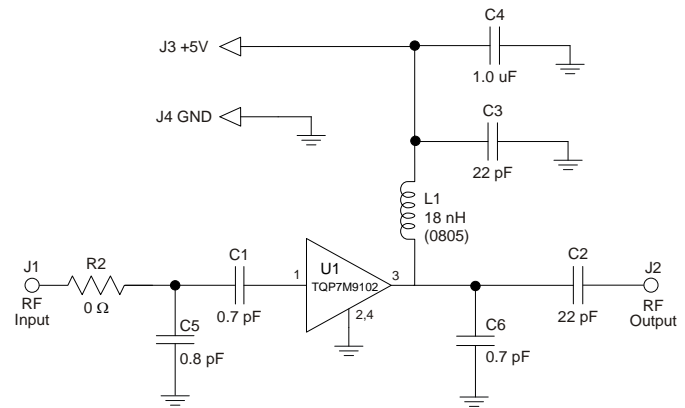
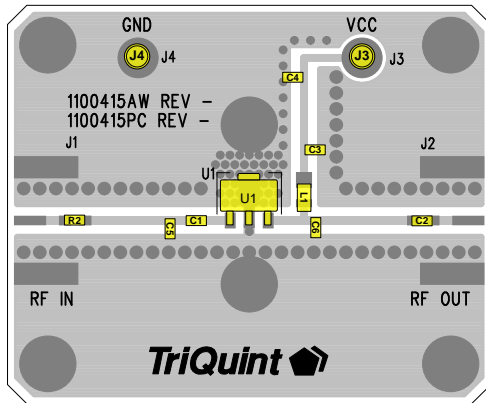

Notes:

7. See Evaluation Board PCB Information for material and stack up.
8. Components shown on the silkscreen but not on the schematic are not used.
9. 0 Ω resistors (R2) may be replaced with copper trace in the target application layout.
10. The recommended component values are dependent upon the frequency of operation.
11. All components are of 0603 size unless stated on the schematic.
12. Critical component placement locations:
 - Distance from U1 Pin 1 (left edge) to C1 (right edge): 87 mils
 - Distance from U1 Pin 1 (left edge) to C5 (right edge): 210 mils
 - Distance from U1 Pin 3 (right edge) to C6 (left edge): 105 mils

Bill of Material 3400 – 3600 MHz Reference Design

Reference Des.	Value	Description	Manuf.	Part Number
n/a	n/a	Printed Circuit Board	Qorvo	
U1	n/a	0.25 W High Linearity Amplifier	Qorvo	TQP7M9102
R2	0 Ω	RES , 0603, 5PCT. 1/16W. CHIP	various	
C1 , C6	0.7 pF	CAP, 0603, \pm 0.1 pF, 50V	various	
C5	0.8 pF	CAP, 0603, \pm 0.1 pF, 50V	various	
C2 , C3	22 pF	CAP, 0603, 5%, 50V, NPO/COG	various	
C4	1.0 uF	CAP, 0603, 10%, X5R , 10V	various	
L1	18 nH	Inductor, 0805, 5%, Coilcraft CS series	Coilcraft	0805CS-180XJLB

Typical Performance 3400 – 3600 MHz Reference Design

Test conditions unless otherwise noted: $V_{CC}=+5V$, $I_{CQ}=137$ mA (typ.), Temp.=+25°C

Parameter	Conditions	Typical Value			Units
		3400	3500	3600	
Frequency		3400	3500	3600	MHz
Gain		14.2	14.5	13.8	dB
Input Return Loss		9	17	9	dB
Output Return Loss		15	11	8	dB
Output P1dB		+27.1	+26.7	+26.2	dBm
OIP3	Pout= +11 dBm/tone, $\Delta f=1$ MHz	+43.3	+44.6	+44.6	dBm
WCDMA Channel Power ⁽¹⁾	-50 dBc ACLR	+18.0	+17.5	+17.0	dBm

Notes:

1. ACLR Test set-up: 3GPP WCDMA, TM1+64 DPCH, +5 MHz offset, PAR = 10.2 dB at 0.01% Prob

Performance Plots 3400 – 3600 MHz Reference Design

Test conditions unless otherwise noted: $V_{CC}=+5\text{ V}$, $I_{CQ}=137\text{ mA}$ (typ.), $Temp.=+25^{\circ}\text{C}$

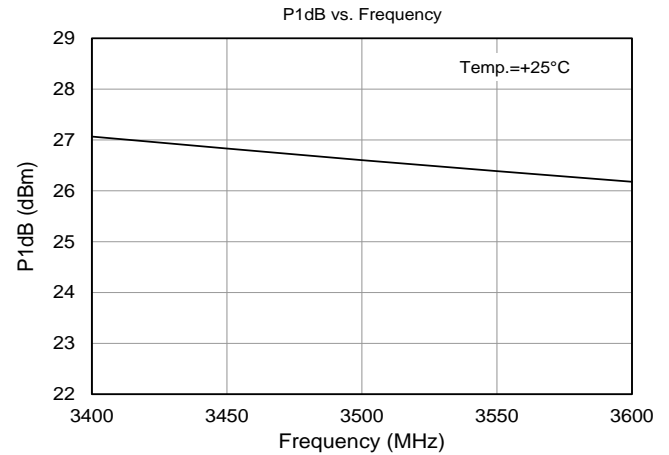
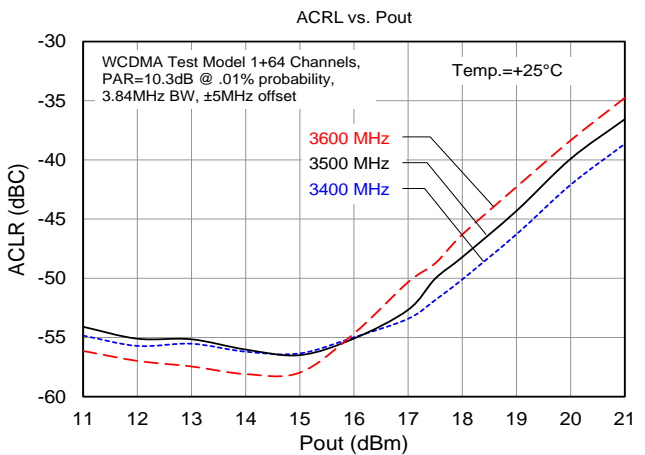
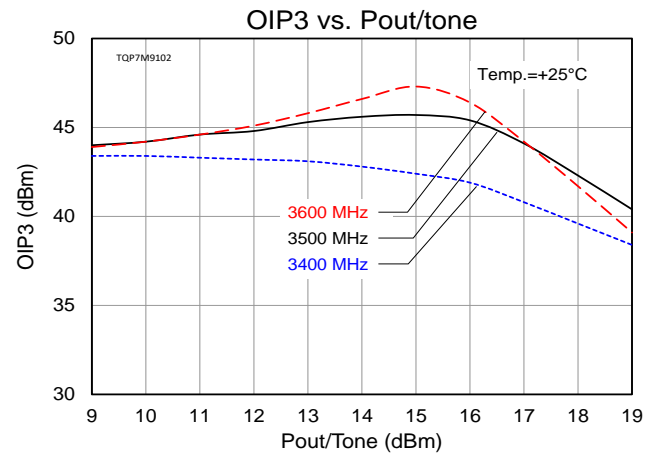
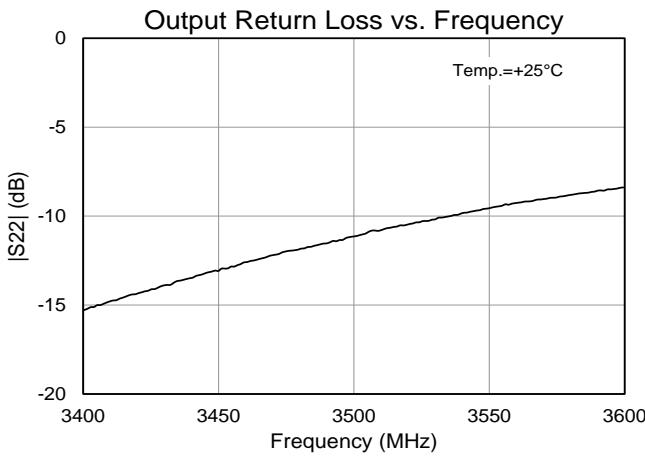
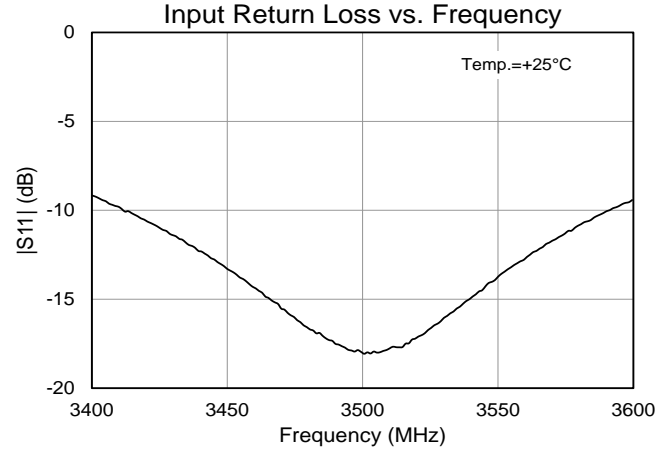
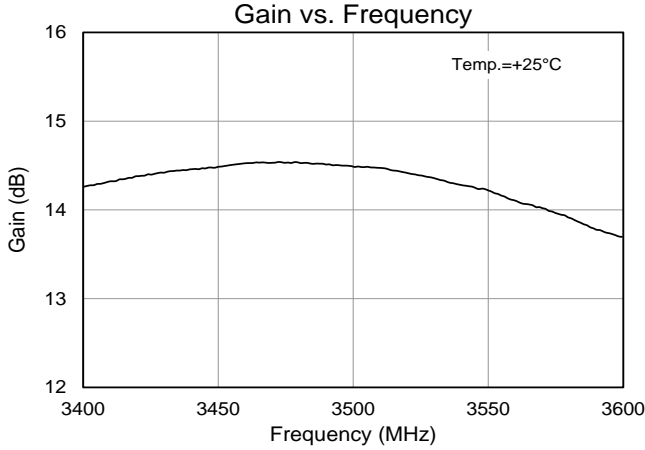

Application Note 1.8-2.2 GHz (1/2 Watt - 1 Watt) Tunable Reference Design

This application note describes the ability to take the TQP7M9102 1.8-2.2 GHz design and tune it from 1/2 Watt to 1 Watt simply by changing the output match (one component). By use of Load-Pull data we were able to see the capability of this part to be tuned from +27 dBm P1dB to +30 dBm by trading off OIP3 performance. This gives the end user the option to run the TQP7M9102 as a 1 Watt device over a wide frequency band.

Below are the different Reference Design options which show the performance trade-offs between P1dB and OIP3 by changing the value and placement of C6.

Evaluation Board

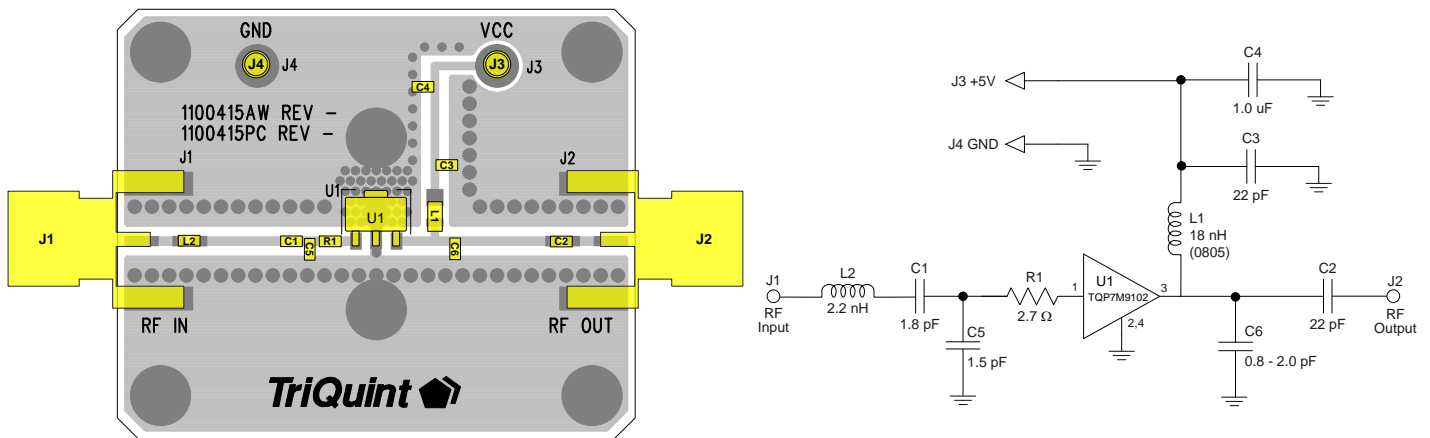

Notes:

1. All components are of 0603 size unless stated on the schematic.
2. The recommended component values are dependent upon the frequency of operation.
3. Critical component placement locations:
 - Distance between U1 Pin 1 Pad to R1 (right edge): 10 mil
 - Distance between U1 Pin 1 Pad to C1 (right edge): 110 mil
 - Distance between U1 Pin 1 Pad to C5 (right edge): 65 mil
 - Distance between U1 Pin 3 Pad to C6 (left edge): see below:

Component Placement

Option	P1dB	C6 Value (pF)	Line Length (mils)	Electrical Length at 2 GHz (degrees)
1	30.0	2.0	145	15.0
2	29.0	1.8	170	17.6
3	28.0	1.2	230	23.8
4	27.0	0.8	290	30.0

Performance Plots 1.8-2.2 GHz (1/2 Watt - 1 Watt) Tunable Reference Design

Test conditions unless otherwise noted: $V_{CC}=+5\text{ V}$, $I_{CQ}=137\text{ mA}$ (typ.), $Temp.=+25^{\circ}\text{C}$

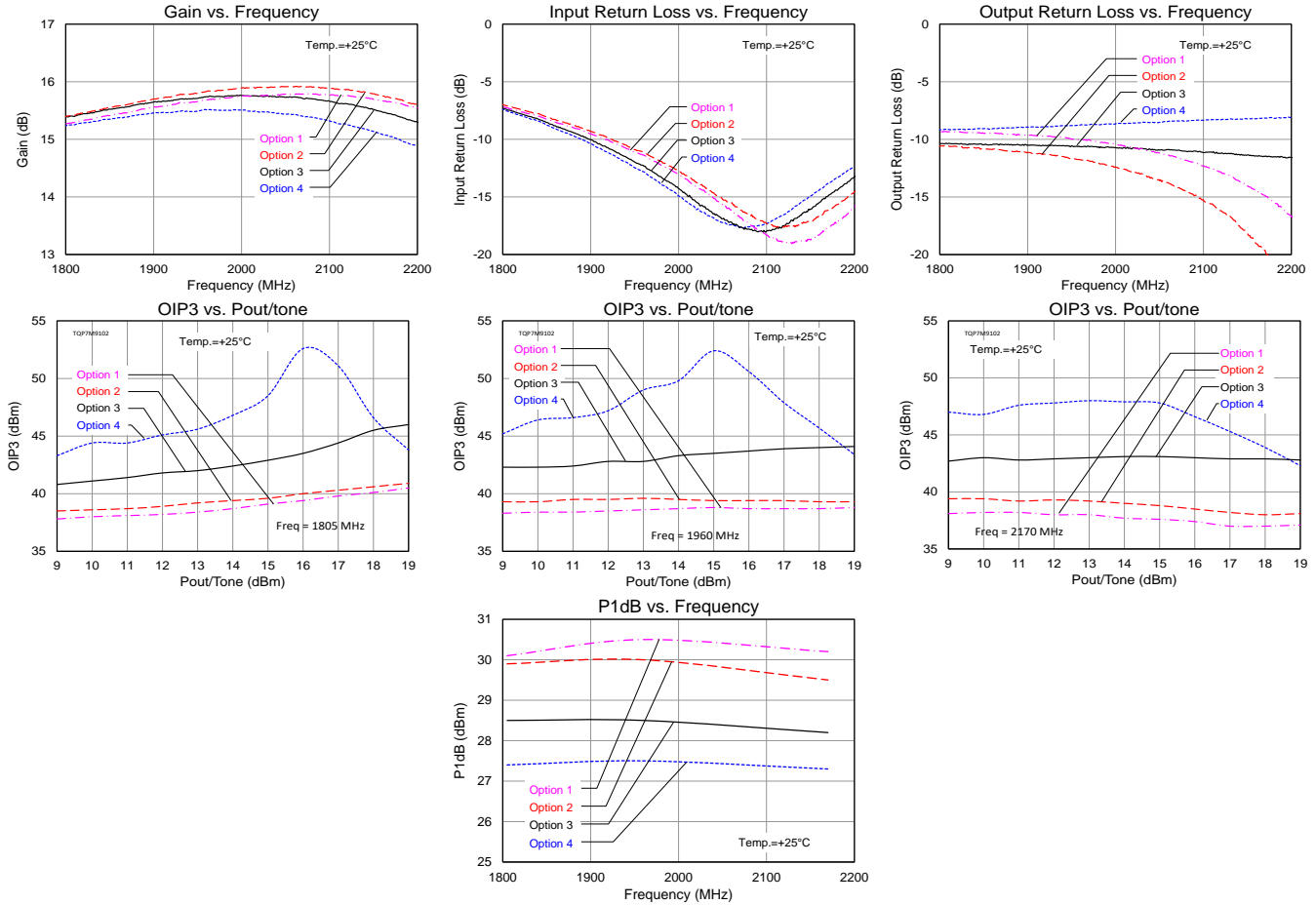

Pin Configuration and Description

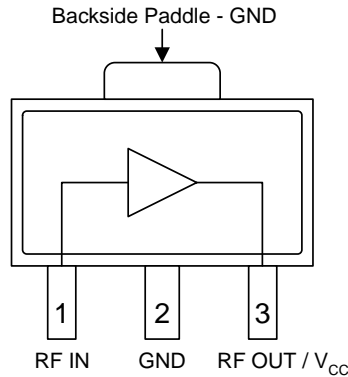

Pin No.	Label	Description
1	RF IN	RF input. External DC Block required. Requires conjugate match for optimal performance.
2, Backside Paddle	GND	RF/DC ground. Use recommended via pattern to minimize inductance and thermal resistance. See PCB Mounting Pattern for suggested footprint.
3	RF OUT/V _{CC}	RF output, matched to 50 ohms. External DC Block and bias voltage required.

Evaluation Board PCB Information

PC Board Layout

PCB Material (stackup):

- 1 oz. Cu top layer
- 0.014 inch Nelco N-4000-13, $\epsilon_r=3.7$
- 1 oz. Cu MIDDLE layer 1
- Core Nelco N-4000-13
- 1 oz. Cu middle layer 2
- 0.014 inch Nelco N-4000-13
- 1 oz. Cu bottom layer
- Finished board thickness is 0.062±.006

50 ohm line dimensions: width = .028", spacing = .028".

The pad pattern shown has been developed and tested for optimized assembly at Qorvo. The PCB land pattern has been developed to accommodate lead and package tolerances. Since surface mount processes vary from supplier to supplier, careful process development is recommended.

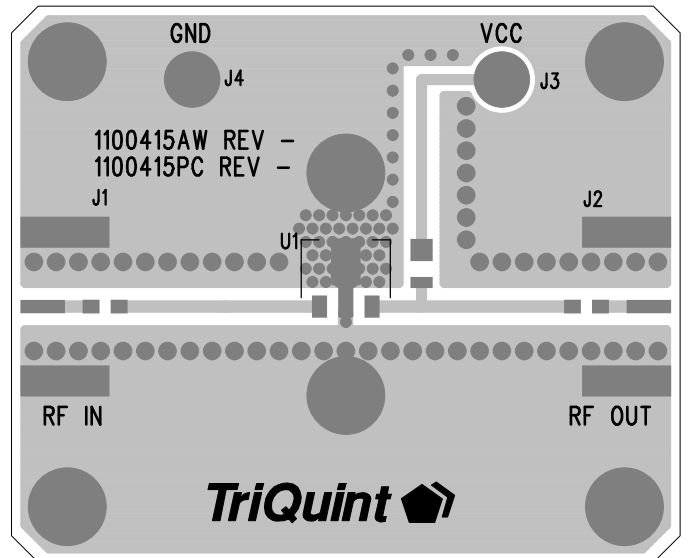

Package Marking and Dimensions

Package Marking

Product ID:
7M9102

Trace Code:
XXXX

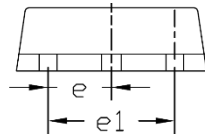
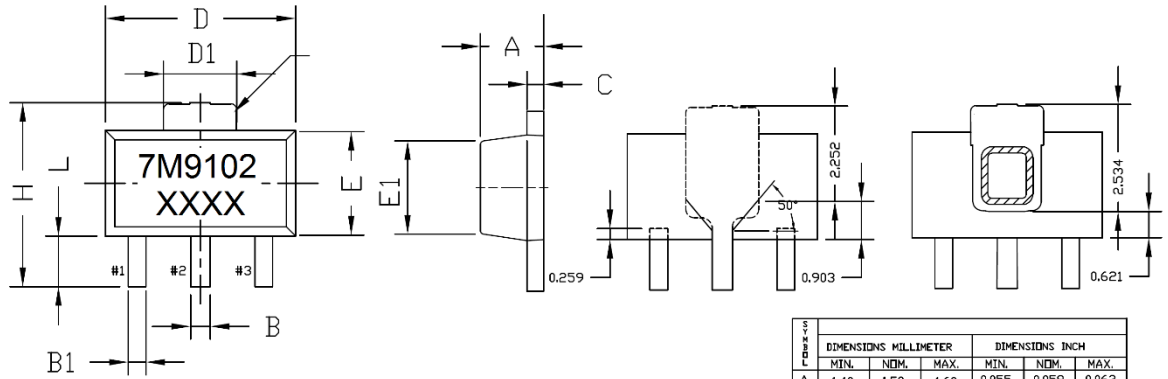

NOTES :
1. DIMENSIONING & TOLERANCING PER ANSI.Y14.5M-1982
2. CONTROLLING DIMENSION : MILLIMETER CONVERTED INCH
ARE NOT NECESSARILY EXACT.
3. DIMENSION B1, 2 PLACES.

DIMENSIONS	DIMENSIONS MILLIMETER			DIMENSIONS INCH		
	MIN.	NOM.	MAX.	MIN.	NOM.	MAX.
A	1.40	1.50	1.60	0.055	0.059	0.063
B	0.42	0.49	0.56	0.017	0.019	0.022
B1	0.36	0.42	0.44	0.014	0.016	0.019
C	0.35	0.40	0.43	0.014	0.016	0.017
D	4.39	4.50	4.60	0.173	0.177	0.181
D1	1.40	1.62	1.83	0.055	0.062	0.072
E	2.29	2.44	2.60	0.090	0.098	0.102
e	1.77	2.03	2.29	0.070	0.074	0.090
e	1.50 BSC			0.059 BSC		
e1	3.00 BSC			0.118 BSC		
H	3.84	4.04	4.25	0.151	0.155	0.167
L	0.74	0.97	1.20	0.029	0.041	0.047

Notes:

1. The terminal #1 identifier and terminal numbering conform to JESD 95-1 SPP-012.
2. Trace code up to 4 characters to be assigned by sub-contractor.

PCB Mounting Pattern

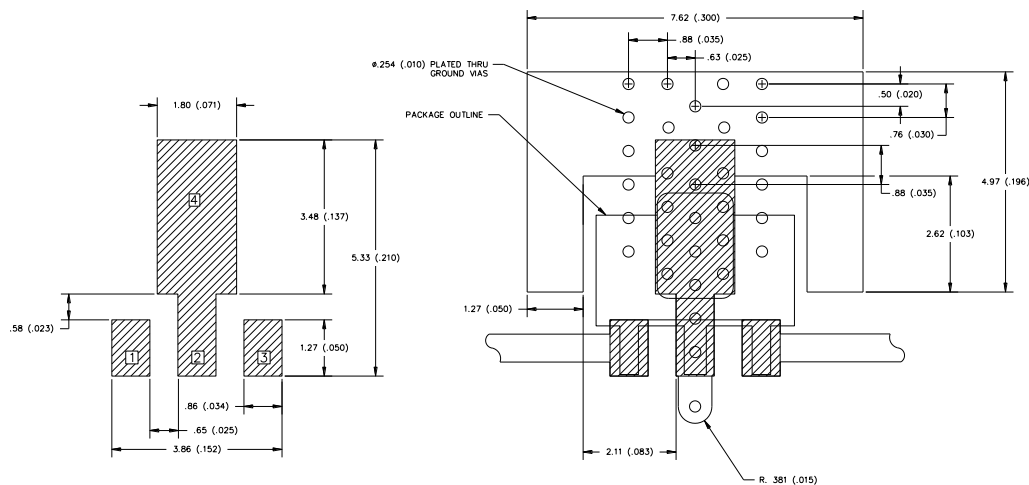

Notes:

1. All dimensions are in millimeters. Angles are in degrees.
2. Use 1 oz. copper minimum for top and bottom layer metal.
3. Via holes are required under the backside paddle of this device for proper RF/DC grounding and thermal dissipation.
4. Do not remove or minimize via hole structure in the PCB. Thermal and RF grounding is critical.
5. We recommend a 0.35mm (#80/.0135") diameter bit for drilling via holes and a final plated thru diameter of 0.25 mm (0.01").
6. Ensure good package backside paddle solder attach for best electrical and thermal performance.

Tape and Reel Information – Carrier and Cover Tape Dimensions



Feature	Measure	Symbol	Size (in)	Size (mm)
Cavity	Length	A0	0.181	4.60
	Width	B0	0.193	4.90
	Depth	K0	0.075	1.90
	Pitch	P1	0.315	8.00
Centerline Distance	Cavity to Perforation - Length Direction	P2	0.079	2.00
	Cavity to Perforation - Width Direction	F	0.217	5.50
Cover Tape	Width	C	0.362	9.20
Carrier Tape	Width	W	0.472	12.0

Tape and Reel Information – Reel Dimensions (7")

Standard T/R size = 1,000 pieces on a 7" reel.



Feature	Measure	Symbol	Size (in)	Size (mm)
Flange	Diameter	A	6.969	177.0
	Thickness	W2	0.717	18.2
	Space Between Flange	W1	0.504	12.8
Hub	Outer Diameter	N	2.283	58.0
	Arbor Hole Diameter	C	0.512	13.0
	Key Slit Width	B	0.079	2.0
	Key Slit Diameter	D	0.787	20.0

Tape and Reel Information – Tape Length and Label Placement



- Notes:
1. Empty part cavities at the trailing and leading ends are sealed with cover tape. See EIA 481-1-A.
 2. Labels are placed on the flange opposite the sprockets in the carrier tape.

Handling Precautions

Parameter	Rating	Standard
ESD – Human Body Model (HBM)	Class 2	ESDA / JEDEC JS-001-2014
ESD – Charged Device Model (CDM)	Class C3	ESDA / JEDEC JS-002-2014
MSL – Moisture Sensitivity Level	Level 1	IPC/JEDEC J-STD-020



Caution!
ESD-Sensitive Device

Solderability

Compatible with lead-free (260°C max. reflow temp.) soldering process.

Solder profiles available upon request.

Contact plating: Annealed Matte Tin

RoHS Compliance

This part is compliant with 2011/65/EU RoHS directive (Restrictions on the Use of Certain Hazardous Substances in Electrical and Electronic Equipment) as amended by Directive 2015/863/EU.

This product also has the following attributes:

- Lead Free
- Halogen Free (Chlorine, Bromine)
- Antimony Free
- TBBP-A (C₁₅H₁₂Br₄O₂) Free
- SVHC Free



Contact Information

For the latest specifications, additional product information, worldwide sales and distribution locations:

Web: www.qorvo.com

Tel: 1-844-890-8163

Email: customer.support@qorvo.com

Important Notice

The information contained herein is believed to be reliable; however, Qorvo makes no warranties regarding the information contained herein and assumes no responsibility or liability whatsoever for the use of the information contained herein. All information contained herein is subject to change without notice. Customers should obtain and verify the latest relevant information before placing orders for Qorvo products. The information contained herein or any use of such information does not grant, explicitly or implicitly, to any party any patent rights, licenses, or any other intellectual property rights, whether with regard to such information itself or anything described by such information. **THIS INFORMATION DOES NOT CONSTITUTE A WARRANTY WITH RESPECT TO THE PRODUCTS DESCRIBED HEREIN, AND QORVO HEREBY DISCLAIMS ANY AND ALL WARRANTIES WITH RESPECT TO SUCH PRODUCTS WHETHER EXPRESS OR IMPLIED BY LAW, COURSE OF DEALING, COURSE OF PERFORMANCE, USAGE OF TRADE OR OTHERWISE, INCLUDING THE IMPLIED WARRANTIES OF MERCHANTABILITY AND FITNESS FOR A PARTICULAR PURPOSE.**

Without limiting the generality of the foregoing, Qorvo products are not warranted or authorized for use as critical components in medical, life-saving, or life-sustaining applications, or other applications where a failure would reasonably be expected to cause severe personal injury or death.

Copyright 2020 © Qorvo, Inc. | Qorvo is a registered trademark of Qorvo, Inc.