

General Description

The TQP7M9102 is a high linearity driver amplifier in a low-cost, RoHS compliant, surface mount package. This InGaP/GaAs HBT delivers high performance across a broad range of frequencies with +44 dBm OIP3 and +27.5 dBm P1dB while only consuming 135 mA quiescent current. All devices are 100% RF and DC tested.

The TQP7M9102 incorporates on-chip features that differentiate it from other products in the market. The amplifier integrates an on-chip DC over-voltage and RF over-drive protection. This protects the amplifier from electrical DC voltage surges and high input RF input power levels that may occur in a system. On-chip ESD protection allows the amplifier to have a very robust Class 2 HBM ESD rating.

The TQP7M9102 is targeted for use as a driver amplifier in wireless infrastructure where high linearity, medium power, and high efficiency are required. The device an excellent candidate for transceiver line cards in current and next generation multi-carrier 3G / 4G base stations.



3 Pin SOT-89 Package

Product Features

- 400 – 4000 MHz
- +27.5 dBm P1dB
- +44 dBm Output IP3
- 17.8 dB Gain at 2140 MHz
- +5 V Single Supply, 135 mA Current
- Internal RF Overdrive Protection
- Internal DC Overvoltage Protection
- On-Chip ESD Protection
- SOT-89 Package

Applications

- Repeaters
- Mobile Infrastructure
- CDMA / WCDMA / LTE
- General Purpose Wireless

Functional Block Diagram

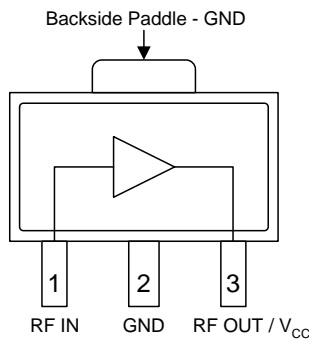

Top View

Ordering Information

| Part No. | Description |
|-------------------|----------------------------------|
| TQP7M9102 | 0.5 W High Linearity Amplifier |
| TQP7M9102-PCB900 | 869 – 960 MHz Evaluation Board |
| TQP7M9102-PCB2140 | 2.11 – 2.17 GHz Evaluation Board |
| TQP7M9102-PCB2600 | 2.5 – 2.7 GHz Evaluation Board |

Standard T/R size = 1000 pieces on a 7" reel

Absolute Maximum Ratings

| Parameter | Rating |
|-----------------------------------|---------------|
| Storage Temperature | -65 to 150 °C |
| RF Input Power, CW, 50Ω, T=25°C | +27 dBm |
| Device Voltage (V _{CC}) | +8 V |

Exceeding any one or a combination of the Absolute Maximum Rating conditions may cause permanent damage to the device. Extended application of Absolute Maximum Rating conditions to the device may reduce device reliability.

Recommended Operating Conditions

| Parameter | Min | Typ | Max | Units |
|--|-------|-----|-------|-------|
| Device Voltage (V _{CC}) | +4.75 | +5 | +5.25 | V |
| T _{CASE} | -40 | | +105 | °C |
| T _j for >10 ⁶ hours MTTF | | | +170 | °C |

Electrical specifications are measured at specified test conditions. Specifications are not guaranteed over all recommended operating conditions.

Electrical Specifications

| Parameter | Conditions ⁽¹⁾ | Min | Typ | Max | Units |
|-------------------------------------|--|-------|-------|------|-------|
| Operational Frequency Range | | 400 | | 4000 | MHz |
| Test Frequency | | | 2140 | | MHz |
| Gain | | 15.5 | 17.8 | | dB |
| Input Return Loss | | | 12 | | dB |
| Output Return Loss | | | 10 | | dB |
| Output P1dB | | +26.4 | +27.5 | | dBm |
| Output IP3 | P _{out} = +8 dBm/tone, Δf = 1 MHz | +41 | +43.8 | | dBm |
| WCDMA Channel Power | -50 dBc ACLR, Note 2 | | +18.5 | | dBm |
| Noise Figure | | | 3.9 | | dB |
| Quiescent Current, I _{CCQ} | | 115 | 137 | 155 | mA |
| Thermal Resistance, θ _{JC} | Junction to case | | | 50 | °C/W |

Notes:

1. Test conditions unless otherwise noted: V_{CC} = +5 V, Temp. = +25 °C, matched 2140 MHz reference circuit
2. ACLR test set-up: 3GPP WCDMA, TM1+64 DPCH, +5 MHz offset, PAR = 10.2 dB at 0.01% Probability

Performance Summary Table

| Frequency | 635 | 768 | 869 | 960 | 1540 | 1840 | 1960 | 2140 | 2140 | 2350 | 2600 | 3500 | MHz |
|--------------------|-------|-------|-------|-------|-------|-------|-------|-------|-------|-------|-------|-------|-----|
| Gain | 22.4 | 20.9 | 21.8 | 21.7 | 20.2 | 20.0 | 18.4 | 15.5 | 17.8 | 16.0 | 14.5 | 14.5 | dB |
| Input Return Loss | 12 | 9 | 10 | 17 | 15 | 17 | 13 | 8 | 12 | 17 | 14.5 | 17 | dB |
| Output Return Loss | 14 | 8 | 12 | 9 | 6 | 7.5 | 7 | 8 | 11 | 8 | 8 | 11 | dB |
| Output P1dB | +27.3 | +28.4 | +27.3 | +27.4 | +28.2 | +27.5 | +27.0 | +30.7 | +27.6 | +27.2 | +28.0 | +26.2 | dBm |
| Output IP3 | +44 | +44 | +43 | +44 | +51 | +42 | +46 | +38 | +44 | +44 | +44 | +45 | dBm |

Notes:

1. Test conditions unless otherwise noted: V_{CC} = +5 V, Temp. = +25 °C, matched reference circuit
2. Reference designs for the various frequencies are either included on this datasheet or may be obtained by contacting appsupport@qorvo.com

Device Characterization Data

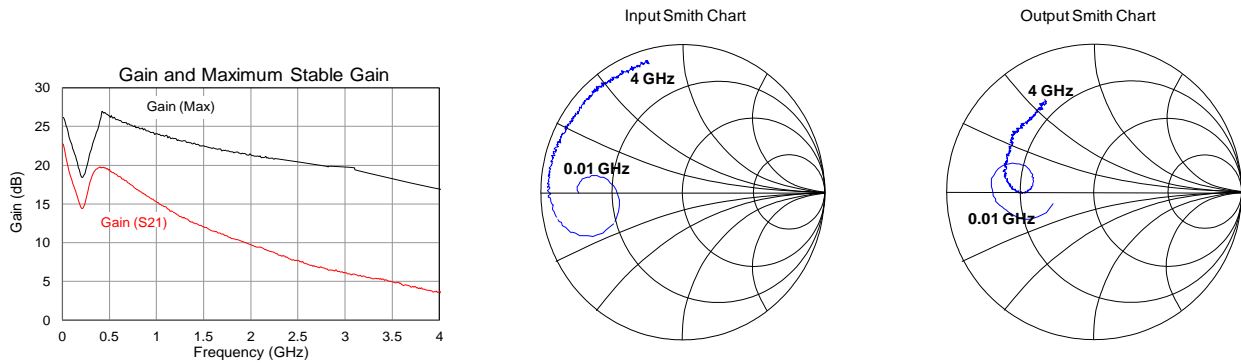

Note: The gain for the unmatched device in a 50 ohm system is shown as the black trace labeled "Gain (S21)". In a circuit tuned for a particular frequency, it is expected that actual gain will be higher, up to the maximum stable gain. The maximum stable gain is shown as the red trace [Gmax]. The impedance Smith chart plots are shown from 0.01 to 4 GHz.

S-Parameters

| Freq (MHz) | S11 (dB) | S11 (ang) | S21 (dB) | S21 (ang) | S12 (dB) | S12 (ang) | S22 (dB) | S22 (ang) |
|------------|----------|-----------|----------|-----------|----------|-----------|----------|-----------|
| 50 | -2.55 | 176.64 | 20.38 | 156.15 | -35.04 | -9.37 | -5.88 | -159.98 |
| 100 | -2.91 | 172.21 | 18.15 | 151.53 | -35.97 | -20.12 | -4.45 | -167.94 |
| 200 | -5.79 | 172.18 | 14.52 | 160.74 | -41.94 | -60.14 | -3.20 | 177.62 |
| 400 | -1.41 | -163.37 | 19.80 | 154.97 | -34.61 | 49.55 | -7.14 | 165.58 |
| 600 | -0.52 | 179.77 | 18.56 | 125.67 | -33.11 | 19.10 | -6.55 | 178.58 |
| 800 | -0.45 | 171.80 | 16.85 | 108.86 | -32.96 | 8.46 | -5.41 | 178.08 |
| 1000 | -0.49 | 165.43 | 15.28 | 95.36 | -32.92 | -1.08 | -4.76 | 174.13 |
| 1200 | -0.60 | 160.30 | 13.79 | 85.52 | -33.15 | -4.65 | -4.38 | 171.06 |
| 1400 | -0.60 | 157.51 | 12.55 | 77.70 | -33.23 | -9.05 | -4.24 | 167.58 |
| 1600 | -0.67 | 152.76 | 11.49 | 69.57 | -33.03 | -15.12 | -4.15 | 163.37 |
| 1800 | -0.74 | 148.28 | 10.53 | 62.39 | -32.96 | -19.02 | -4.00 | 159.18 |
| 2000 | -0.72 | 143.55 | 9.75 | 54.69 | -33.03 | -20.90 | -3.89 | 155.31 |
| 2200 | -0.78 | 139.03 | 8.88 | 48.56 | -32.96 | -25.51 | -3.77 | 150.66 |
| 2400 | -0.71 | 135.24 | 7.99 | 42.25 | -32.88 | -27.98 | -3.40 | 146.69 |
| 2600 | -0.74 | 131.98 | 7.23 | 36.47 | -33.43 | -30.45 | -3.38 | 144.96 |
| 2800 | -0.75 | 128.79 | 6.58 | 31.19 | -33.15 | -33.43 | -3.44 | 142.02 |
| 3000 | -0.80 | 126.32 | 6.09 | 26.41 | -33.23 | -36.48 | -3.50 | 139.73 |
| 3200 | -0.75 | 122.75 | 5.69 | 20.73 | -33.43 | -37.86 | -3.39 | 137.14 |
| 3400 | -0.81 | 118.06 | 5.30 | 14.38 | -33.39 | -44.57 | -3.48 | 130.99 |
| 3600 | -0.82 | 113.62 | 4.59 | 7.77 | -33.03 | -43.44 | -3.34 | 124.40 |
| 3800 | -0.71 | 108.88 | 4.07 | 1.73 | -32.92 | -50.92 | -3.04 | 120.16 |
| 4000 | -0.68 | 105.86 | 3.64 | -2.85 | -33.15 | -54.00 | -2.92 | 118.44 |

Test Conditions: $V_{CC} = +5\text{ V}$, $I_{CC} = 135\text{ mA}$, Temp. = $+25\text{ }^{\circ}\text{C}$, unmatched 50 Ohm system, reference plane at device leads

617 – 652 MHz Reference Design

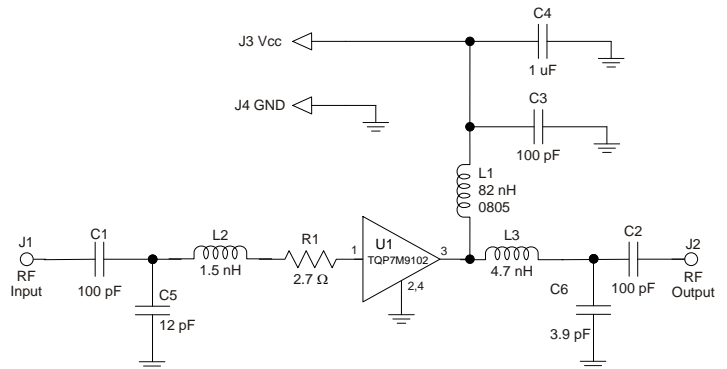
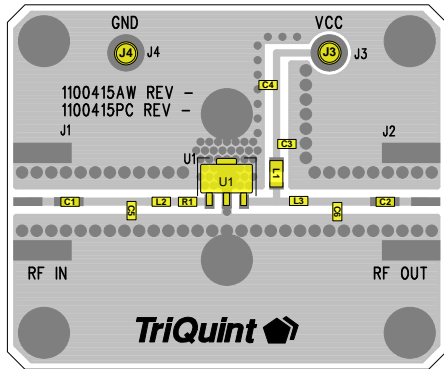

Notes:

1. See Evaluation Board PCB Information for material and stack up.
2. The recommended component values are dependent upon the frequency of operation.
3. All components are of 0603 size unless stated on the schematic.
4. Critical component placement locations:
 - Distance from U1 Pin Pad 1 (left edge) to R1 (right edge): 20 mils
 - Distance from U1 Pin Pad 1 (left edge) to L2 (right edge): 90 mils
 - Distance from U1 Pin Pad 1 (left edge) to C5 (right edge): 235 mils
 - Distance from U1 Pin Pad 3 (right edge) to L3 (left edge): 120 mils
 - Distance from U1 Pin Pad 3 (right edge) to C6 (left edge): 255 mils

Bill of Material 617 – 652 MHz Reference Design

| Reference Des. | Value | Description | Manuf. | Part Number |
|----------------|--------|------------------------------------|-----------|---------------|
| n/a | n/a | Printed Circuit Board | Qorvo | |
| U1 | n/a | ½ W High Linearity Amplifier | Qorvo | TQP7M9102 |
| C1 , C2 , C3 | 100 pF | CAP, 0603, +/-5%. 100V NPO/COG | various | |
| C5 | 12 pF | CAP, 0603, +/-2%. 50V. NPO/COG | various | |
| C6 | 3.9 pF | CAP, 0603, +/-0.1PF. 100V. NPO/COG | various | |
| C4 | 1.0 uF | CAP, 0603, 10%, X5R, 10V | various | |
| L1 | 82 nH | IND, 0805, 5%, Ceramic | Coilcraft | 0805CS-820XJL |
| L2 | 1.5 nH | IND, 0603 | various | |
| L3 | 4.7 nH | IND, 0603 | various | |
| R1 | 2.7 Ω | Resistor, Chip, 0603, 5%, 1/16W | various | |

Typical Performance 617 – 652 MHz Reference Design

Test conditions unless otherwise noted: $V_{CC}=+5V$, $I_{CO}=137\text{ mA}$ (typ.), Temp.=+25 °C

| Parameter | Conditions | Typical Value | | | Units |
|--------------------------------|-------------------------------|---------------|-------|-------|-------|
| Frequency | | 617 | 635 | 652 | MHz |
| Gain | | 22.3 | 22.4 | 22.4 | dB |
| Input Return Loss | | 10 | 12 | 14 | dB |
| Output Return Loss | | 16 | 14 | 12 | dB |
| Output P1dB | | +27.1 | +27.3 | +27.3 | dBm |
| Output IP3 | Pout= +15 dBm/tone, Δf= 1 MHz | +43.0 | +43.8 | +43.7 | dBm |
| LTE Chan. Power ⁽¹⁾ | -50 dBc ACLR | +15.8 | +16.3 | +16.5 | dBm |

Notes:

1. ACLR test set-up: 1 CH, 20 MHz BW, LTE E-TM1.1, 9.5 dB PAR at 0.01% Probability

Performance Plots 617 – 652 MHz Reference Design

Test conditions unless otherwise noted: $V_{CC}=+5V$, $I_{CQ}=137\text{ mA}$ (typ.)

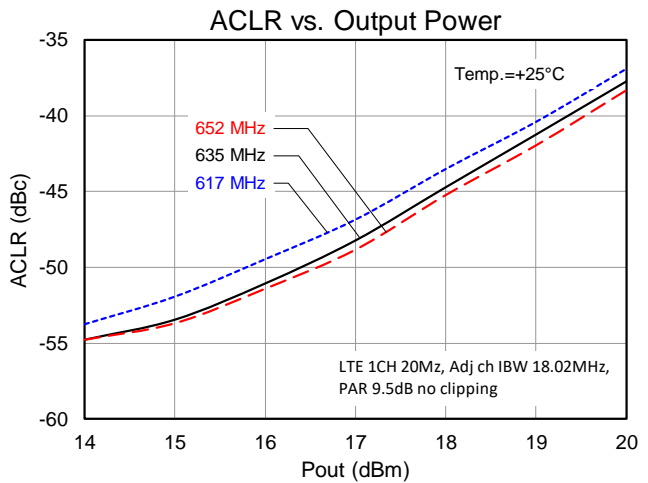
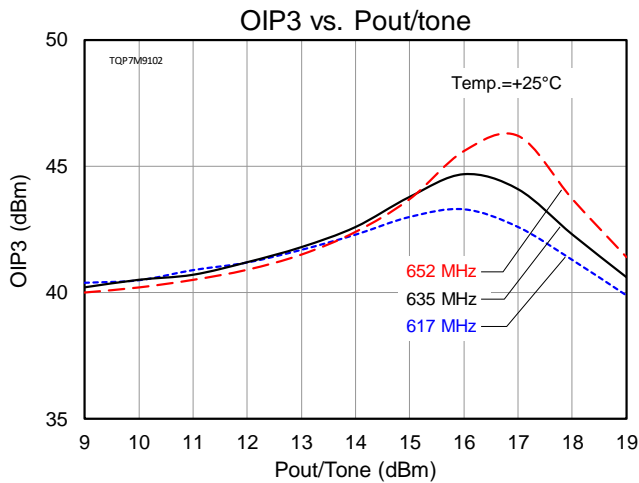
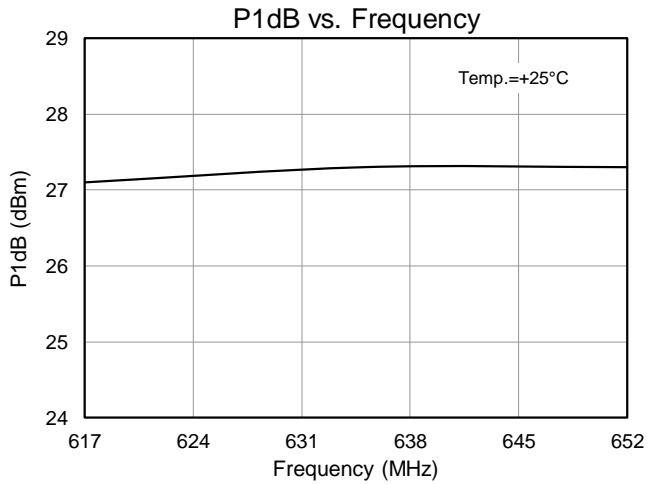
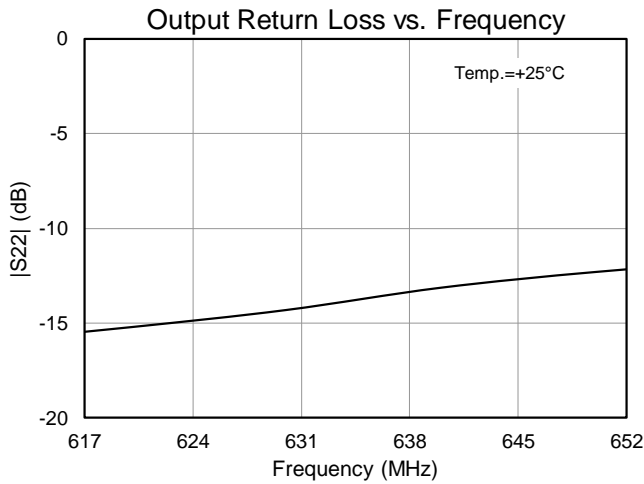
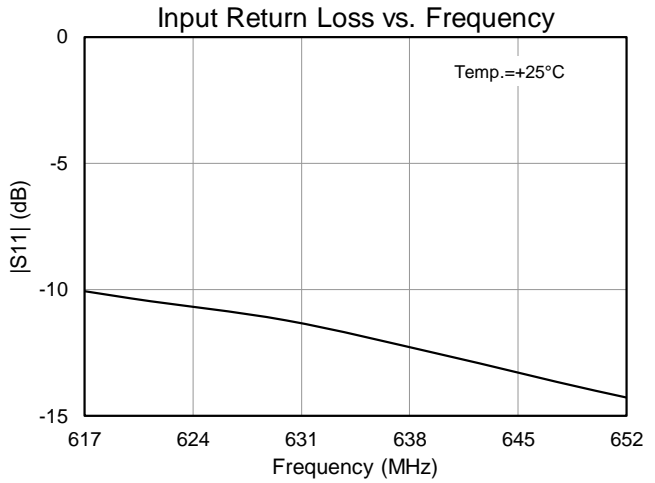
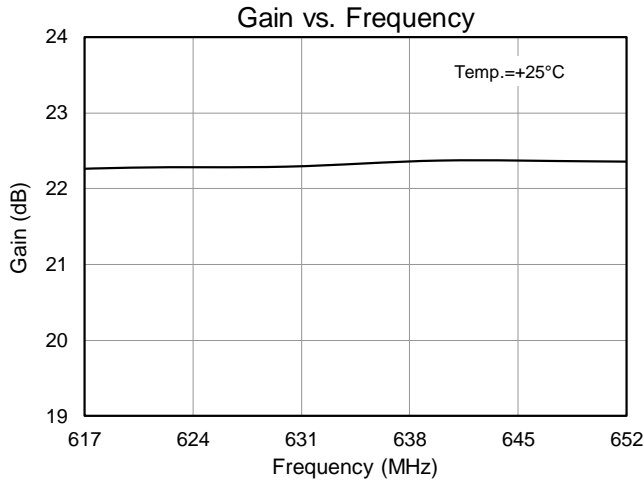

746 – 768 MHz Reference Design

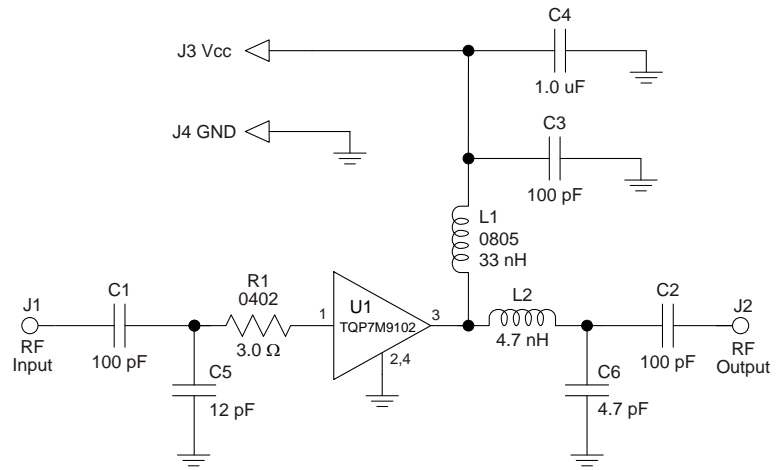
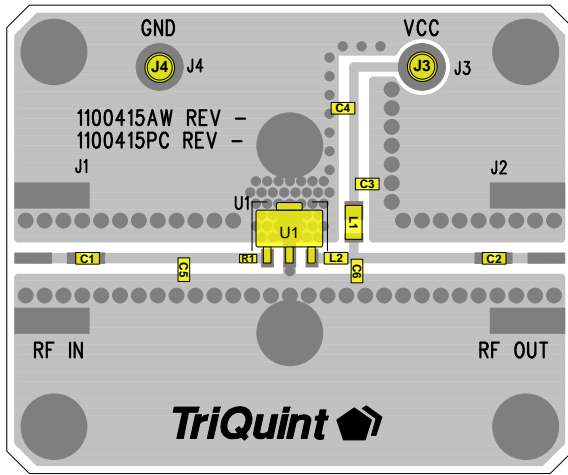

Notes:

5. See Evaluation Board PCB Information for material and stack up.
6. The recommended component values are dependent upon the frequency of operation.
7. All components are of 0603 size unless stated on the schematic.
8. Critical component placement locations:
 - Distance from U1 Pin Pad 1 (left edge) to R1 (right edge): 0 mils
 - Distance from U1 Pin Pad 1 (left edge) to C6 (right edge): 60 mils
 - Distance from U1 Pin Pad 1 (left edge) to C5 (right edge): 230 mils
 - Distance from U1 Pin Pad 3 (right edge) to L2 (left edge): 0 mils

Bill of Material 746 – 768 MHz Reference Design

| Reference Des. | Value | Description | Manuf. | Part Number |
|----------------|--------|------------------------------------|-----------|----------------|
| n/a | n/a | Printed Circuit Board | Qorvo | |
| U1 | n/a | ½ W High Linearity Amplifier | Qorvo | TQP7M9102 |
| C1, C2, C3 | 100 pF | CAP, 0603, +/-5%. 100V NPO/COG | various | |
| C5 | 12 pF | CAP, 0603, +/-2%. 50V. NPO/COG | various | |
| C6 | 4.7 pF | CAP, 0603, +/-0.1PF. 100V. NPO/COG | various | |
| C4 | 1.0 uF | CAP, 0603, 10%, X5R, 10V | various | |
| L1 | 33 nH | IND, 0805, 5%, Ceramic | Coilcraft | 0805CS-330XJL |
| L2 | 4.7 nH | IND, 0603, +/-0.3. >5600MHZ | Toko | LL1608-FSL4N7S |
| R1 | 3.0 Ω | Resistor, Chip, 0603, 5%, 1/16W | various | |

Typical Performance 746 – 768 MHz Reference Design

Test conditions unless otherwise noted: $V_{CC}=+5V$, $I_{CO}=137mA$ (typ.), Temp.=+25 °C

| Parameter | Conditions | Typical Value | | Units |
|--------------------|-------------------------------|---------------|-------|-------|
| Frequency | | 746 | 768 | MHz |
| Gain | | 20.9 | 20.9 | dB |
| Input Return Loss | | 8 | 9 | dB |
| Output Return Loss | | 10 | 8 | dB |
| Output P1dB | | +28.2 | +28.4 | dBm |
| Output IP3 | Pout= +18 dBm/tone, Δf= 1 MHz | +47 | +44 | dBm |

Performance Plots 746 – 768 MHz Reference Design

Test conditions unless otherwise noted: $V_{CC}=+5V$, $I_{CQ}=137\text{ mA}$ (typ.)

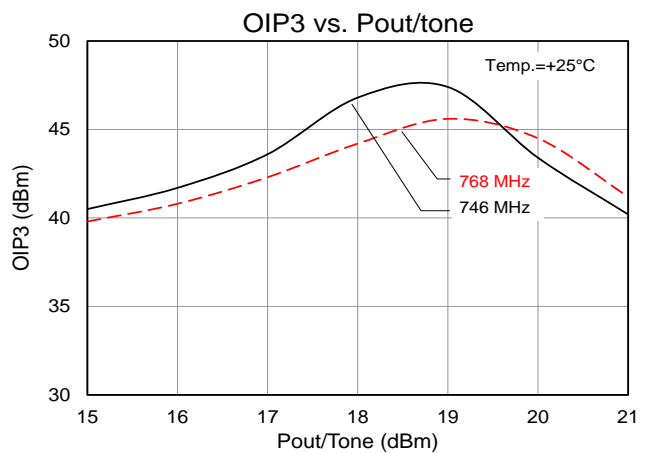
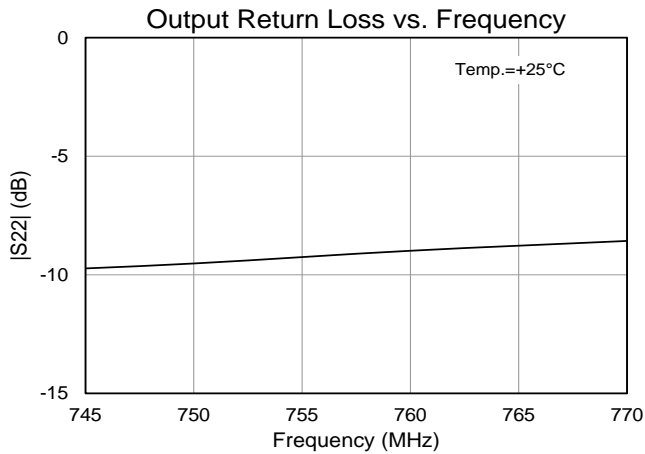
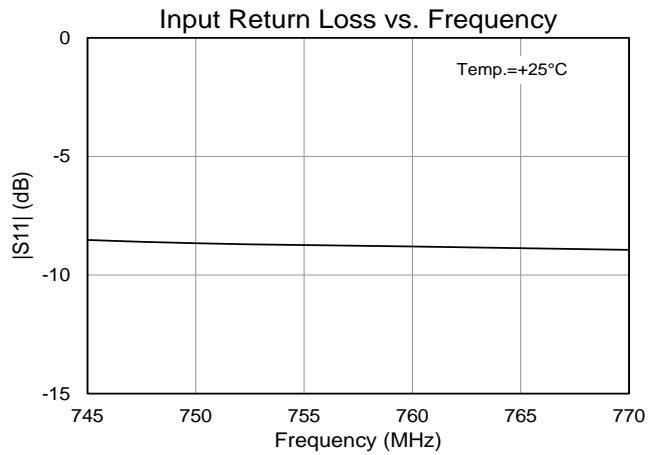
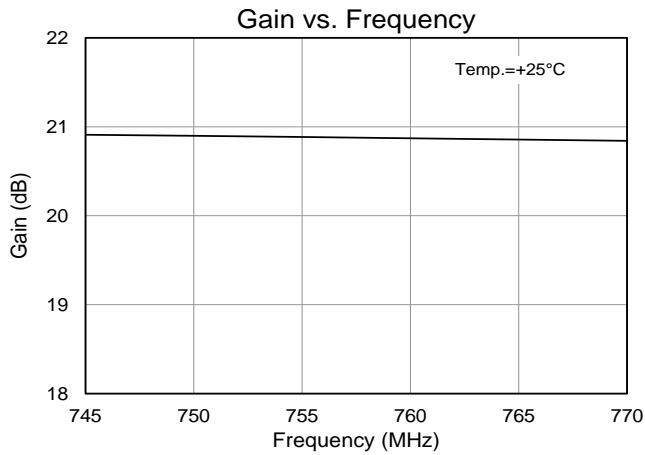

869 – 960 MHz Evaluation Board (TQP7M9102-PCB900)

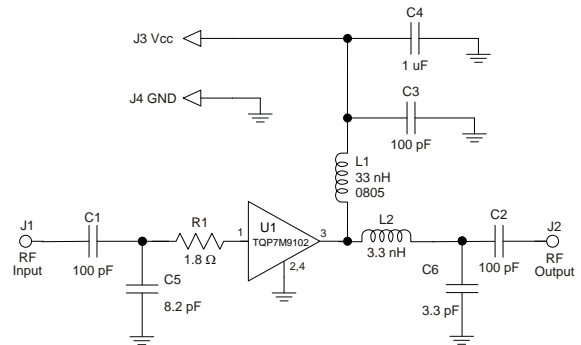
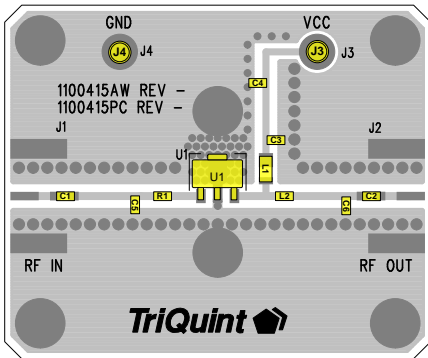

Notes:

1. See Evaluation Board PCB Information for material and stack up.
2. Components shown on the silkscreen but not on the schematic are not used.
3. The recommended component values are dependent upon the frequency of operation.
4. All components are of 0603 size unless stated on the schematic.
5. Critical component placement locations:
 - Distance from U1 Pin 1 (left edge) to R1 (right edge): 90 mils (4.3 deg. at 920 MHz)
 - Distance from R1 (left edge) to C5 (right edge): 70 mils (3.3 deg. at 920 MHz)
 - Distance from U1 Pin 3 (right edge) to L2 (left edge): 120 mils (5.7 deg. at 920 MHz)
 - Distance from U1 Pin 3 (right edge) to C6 (left edge): 370 mils (17.6 deg. at 920 MHz)

Bill of Material TQP7M9102-PCB900

| Reference Des. | Value | Description | Manuf. | Part Number |
|----------------|--------|---|-----------|----------------|
| n/a | n/a | Printed Circuit Board | Qorvo | |
| U1 | n/a | TQP7M9102 Amplifier, SOT-89 pkg. | Qorvo | TQP7M9102 |
| R1 | 1.8 Ω | Resistor, Chip, 0603, 5%, 1/16W | various | |
| L2 | 3.3 nH | Inductor, 0603, +/-0.3 nH | Toko | LL1608-FSL3N3S |
| L1 | 33 nH | Inductor, 0805, 5%, Coilcraft CS Series | Coilcraft | 0805CS-330XJLB |
| C5 | 8.2 pF | Cap., Chip, 0603, +/-0.1pF. 200V. | AVX | 06032U8R2BAT2A |
| C6 | 3.3 pF | Cap., Chip, 0603, +/-0.1pF. 200V. | AVX | 06032U3R3BAT2A |
| C1, C2, C3 | 100 pF | Cap., Chip, 5%, 50V, NPO/COG | various | |
| C4 | 1.0 uF | Cap., Chip, 10%, 10V, X5R | various | |

Typical Performance TQP7M9102-PCB900

Test conditions unless otherwise noted: $V_{CC}=+5V$, $I_{CQ}=137\text{ mA}$ (typ.), $Temp.=+25\text{ }^{\circ}\text{C}$

| Parameter | Conditions | Typical Value | | | Units |
|------------------------------------|---|---------------|-------|-------|-------|
| Frequency | | 869 | 920 | 960 | MHz |
| Gain | | 21.8 | 21.9 | 21.7 | dB |
| Input Return Loss | | 10 | 16 | 17 | dB |
| Output Return Loss | | 12 | 10 | 9 | dB |
| Output P1dB | | +27.3 | +27.4 | +27.4 | dBm |
| OIP3 | $P_{out}= +19\text{ dBm/ tone, } \Delta f=1\text{ MHz}$ | +42.7 | +43.4 | +43.9 | dBm |
| WCDMA Channel Power ⁽¹⁾ | -50 dBc ACLR | +18.0 | +18.2 | +18.1 | dBm |
| Noise Figure | | 5.9 | 5.9 | 5.9 | dB |

Notes:

1. ACLR Test set-up: 3GPP WCDMA, TM1+64 DPCH, +5 MHz offset, PAR = 10.2 dB at 0.01% Probability

Performance Plots TQP7M9102-PCB900

Test conditions unless otherwise noted: $V_{CC}=+5V$, $I_{CQ}=137\text{ mA}$ (typ.)

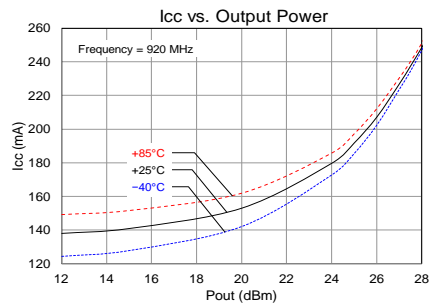
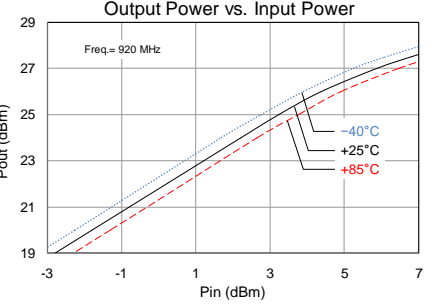
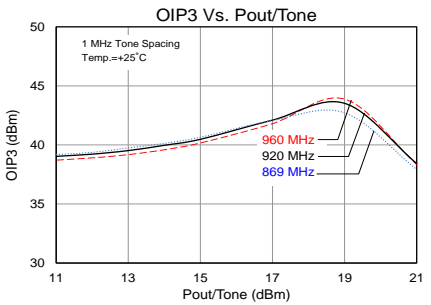
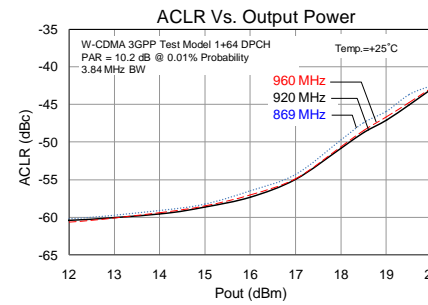
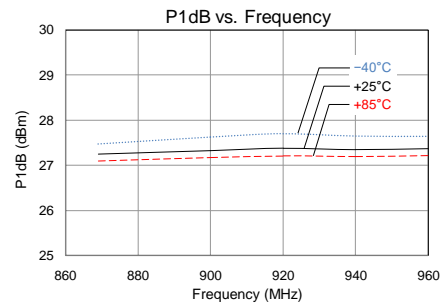
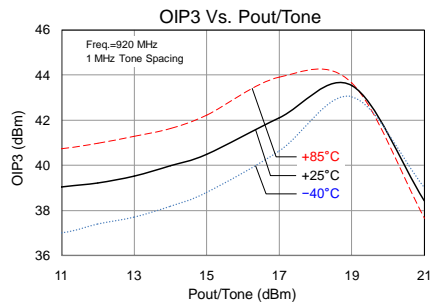
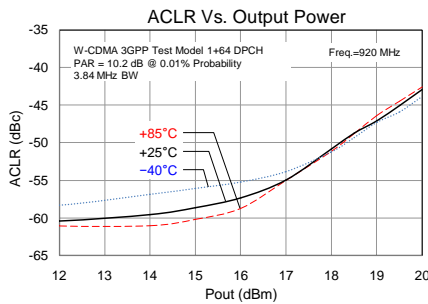
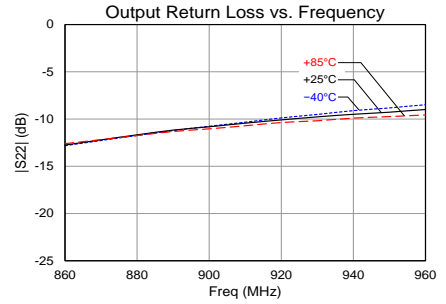
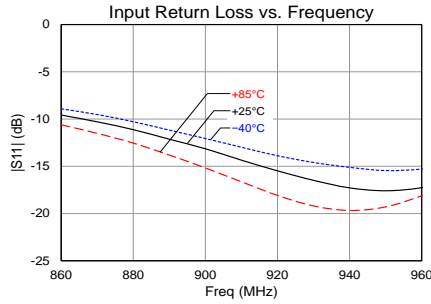
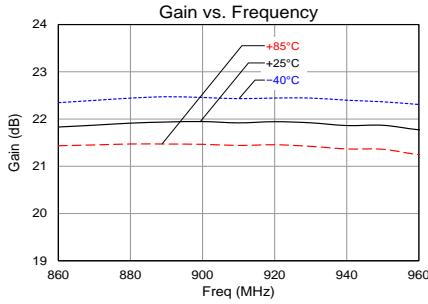

700 – 1000 MHz Reference Design

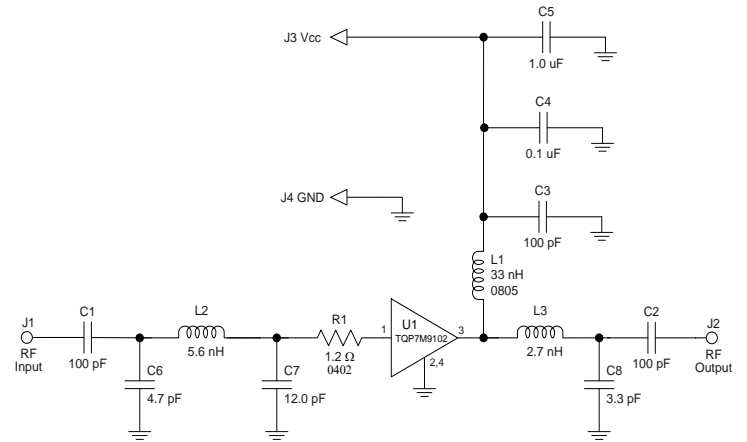
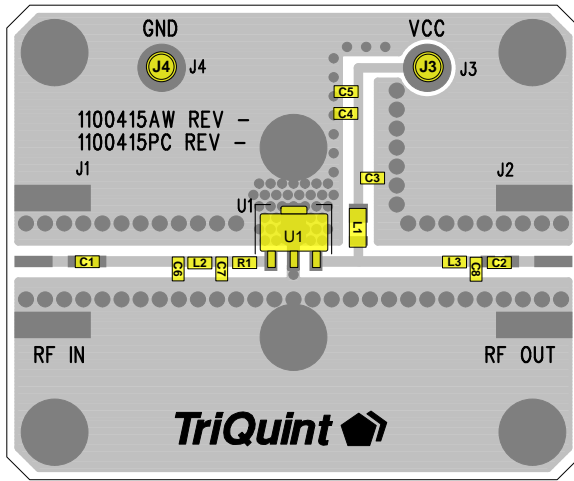

Notes:

1. The recommended component values are dependent upon the frequency of operation.
2. All components are of 0603 size unless stated on the schematic.
3. Entire Bias network values are critical of linearity performance.
4. Critical component placement locations:
 - Distance from U1 Pin 1 (left edge) to R1 (right edge): 10 mils (0.5 deg at 920 MHz)
 - Distance from R1 (left edge) to C7 (right edge): 10 mils (0.5 deg at 920 MHz)
 - Distance from C7 (left edge) to L2 (right edge): 10 mils (0.5 deg at 920 MHz)
 - Distance from L2 (left edge) to C6 (right edge): 20 mils (1.0 deg at 920 MHz)
 - Distance from U1 Pin 3 (right edge) to L3 (left edge): 290 mils (13.8 deg at 920 MHz)
 - Distance from L3 (right edge) to C8 (left edge): 20 mils (1.0 deg at 920 MHz)

Bill of Material 700 – 1000 MHz Reference Design

| Reference Des. | Value | Description | Manuf. | Part Number |
|----------------|--------|--|-----------|-----------------|
| n/a | n/a | Printed Circuit Board | Qorvo | |
| U1 | n/a | ½ W High Linearity Amplifier | Qorvo | TQP7M9102 |
| C1,C2,C3 | 100 pF | 0603, 5%, 50 V, NPO/COG | various | |
| C4 | 0.1 µF | 0603, 10%, 50 V, X7R | various | |
| C5 | 1.0 µF | 0603, 10%, 10 V, X5R | Various | LL-1608-FSL1N2S |
| L1 | 33 nH | 0805, 5%, cer core,0805 Coilcraft | Coilcraft | 0805CS-330XJL |
| L2 | 5.6 nH | 0603, ± 0.3 nH, multilayer, Toko | Toko | LL1608-FSL5N6S |
| L3 | 2.7 nH | 0603, ± 0.3 nH, multilayer, Toko | Toko | LL1608-FSL2N7S |
| C6 | 4.7 pF | 0603, ± 0.1 pF, 200 V, NPO/COG, AVX U Series | AVX | 06032U4R7BAT2A |
| C7 | 12 pF | 0603, 2%, 50 V, NPO/COG | Various | |
| C8 | 3.3 pF | 0603, ± 0.1 pF, 200 V, NPO/COG, AVX U Series | AVX | 06032U3R3BAT2A |

Typical Performance 700 – 1000 MHz Reference Design

Test conditions unless otherwise noted: $V_{CC}=+5\text{ V}$, $I_{CQ}=135\text{ mA}$, $Temp = +25\text{ }^{\circ}\text{C}$, $50\ \Omega$ system

| Parameter | Conditions | Typical Value | | | Units |
|--------------------|--|---------------|------|-------|-------|
| Frequency | | 700 | 850 | 1000 | MHz |
| Gain | | 22.2 | 21.8 | 21.1 | dB |
| Input Return Loss | | 6.3 | 7.7 | 7.2 | dB |
| Output Return Loss | | 18.8 | 14.2 | 15.2 | dB |
| Output P1dB | | +27.4 | +28 | +28.3 | dBm |
| Output IP3 | Pout= +16 dBm / tone, $\Delta f= 1\text{ MHz}$ | +42.3 | +43 | +41.3 | dBm |

Performance Plots 700 – 1000 MHz Reference Design

Test conditions unless otherwise noted: $V_{CC}=+5\text{ V}$, $I_{CQ}=137\text{ mA}$ (typ.), $Temp.=+25\text{ }^{\circ}\text{C}$

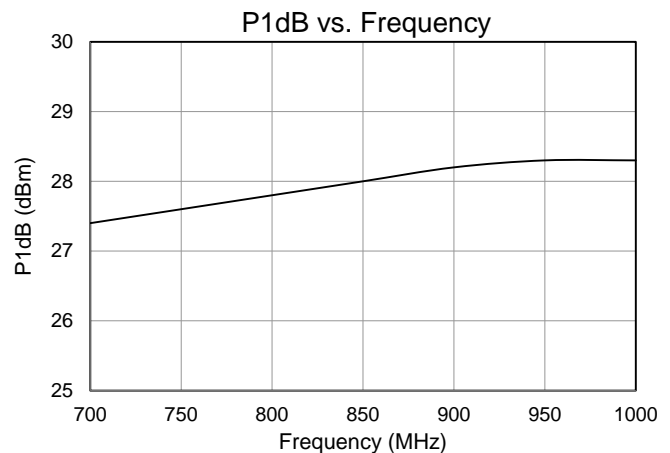
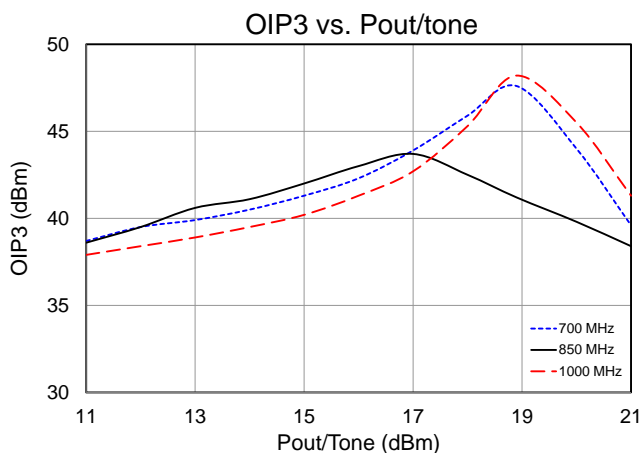
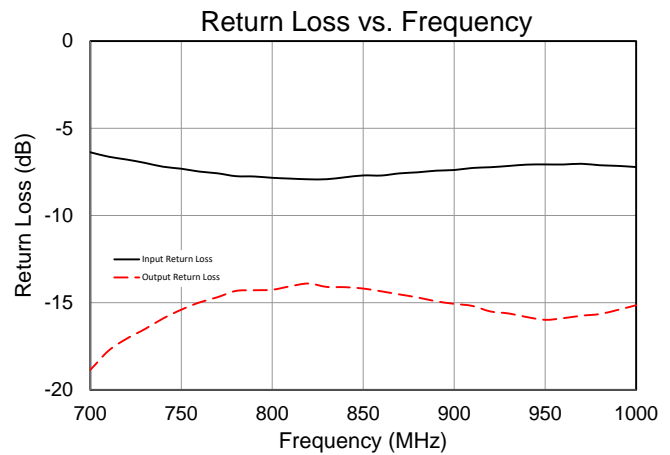
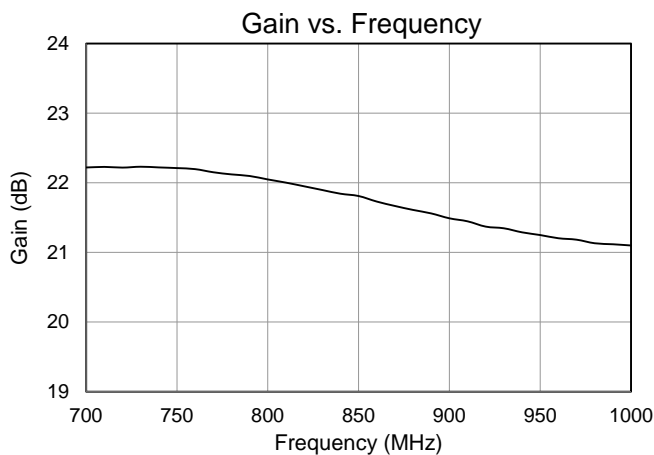

1800 – 2200 MHz 1 Watt Reference Design

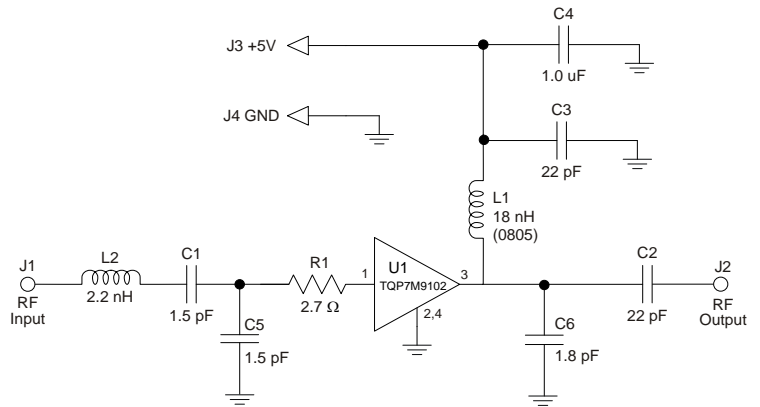
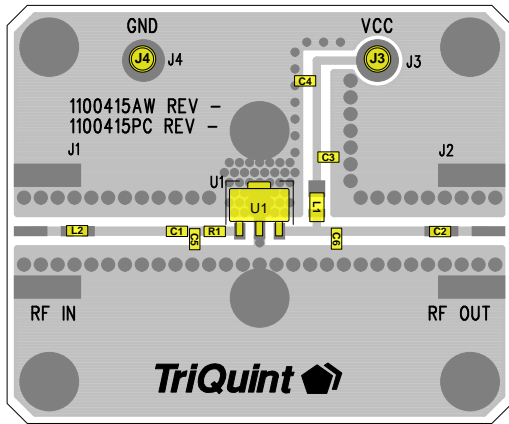

Notes:

1. See Evaluation Board PCB Information for material and stack up.
2. Components shown on the silkscreen but not on the schematic are not used.
3. 0 Ω resistors (R2) may be replaced with copper trace in the target application layout.
4. The recommended component values are dependent upon the frequency of operation.
5. All components are of 0603 size unless stated on the schematic.
6. Critical component placement locations:
 - Distance from U1 Pin 1 (left edge) to R1 (right edge): 25 mils
 - Distance from U1 Pin 1 (left edge) to C1 (right edge): 145 mils
 - Distance from U1 Pin 1 (left edge) to C5 (right edge): 90 mils
 - Distance from U1 Pin 3 (right edge) to C6 (left edge): 145 mils

Bill of Material 1800 – 2200 MHz 1 Watt Reference Design

| Reference Des. | Value | Description | Manuf. | Part Number |
|----------------|--------|------------------------------------|-----------|-----------------|
| n/a | n/a | Printed Circuit Board | Qorvo | |
| U1 | n/a | ½ W High Linearity Amplifier | Qorvo | TQP7M9102 |
| C2 , C3 | 22 pF | CAP, 0603, +/-1%. 200V NPO/COG | various | |
| C1, C5 | 1.5 pF | CAP, 0603, +/-0.1pF. 200V. NPO/COG | various | |
| L2 | 2.2 nH | Ind, chip, 0603, +/-0.3nH >6000MHz | Toko | LL-1608-FSL1N2S |
| C4 | 1.0 uF | CAP, 0603, 10%, X5R , 10V | various | |
| L1 | 18 nH | IND, 0805, 5%, Ceramic | Coilcraft | 0805CS-180XJL |
| C6 | 1.8pF | CAP, 0603, +/-0.1pF. 200V. NPO/COG | various | |
| R1 | 2.7 Ω | RES, 0603, 5% | various | |

Typical Performance 1800 – 2200 MHz 1 Watt Reference Design

Test conditions unless otherwise noted: $V_{CC} = +5V$, $I_{CQ} = 137$ mA (typ.), Temp= +25°C

| Parameter | Conditions | Typical Value | | | Units |
|--------------------|-------------------------------|---------------|-------|-------|-------|
| | | 1800 | 2000 | 2200 | |
| Frequency | | 1800 | 2000 | 2200 | MHz |
| Gain | | 15.3 | 15.5 | 15.4 | dB |
| Input Return Loss | | 7.5 | 8 | 9 | dB |
| Output Return Loss | | 7 | 8 | 8 | dB |
| Output P1dB | | +29.7 | +30.7 | +29.9 | dBm |
| Output IP3 | Pout= +15 dBm/tone, Δf= 1 MHz | +38 | +38 | +38 | dBm |

Performance Plots 1800 – 2200 MHz 1 Watt Reference Design

Test conditions unless otherwise noted: $V_{CC}=+5\text{ V}$, $I_{CQ}=137\text{ mA}$ (typ.), $Temp.=+25\text{ }^{\circ}\text{C}$

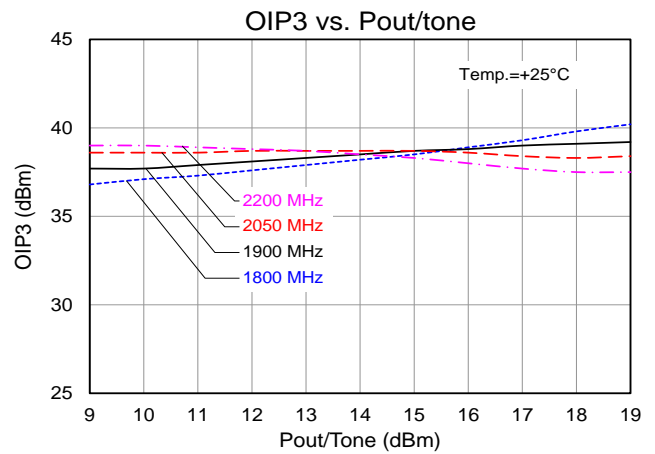
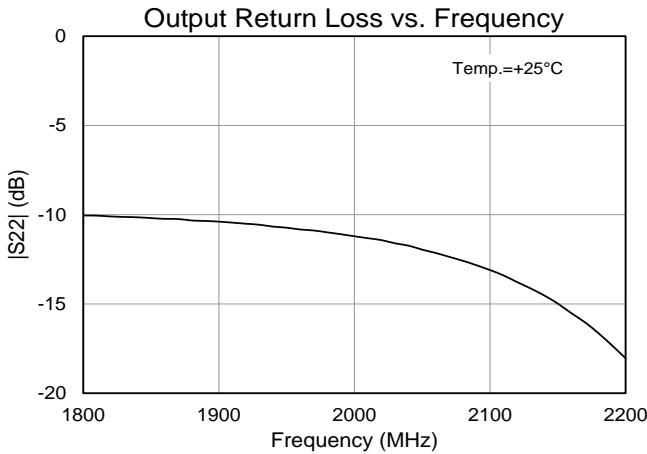
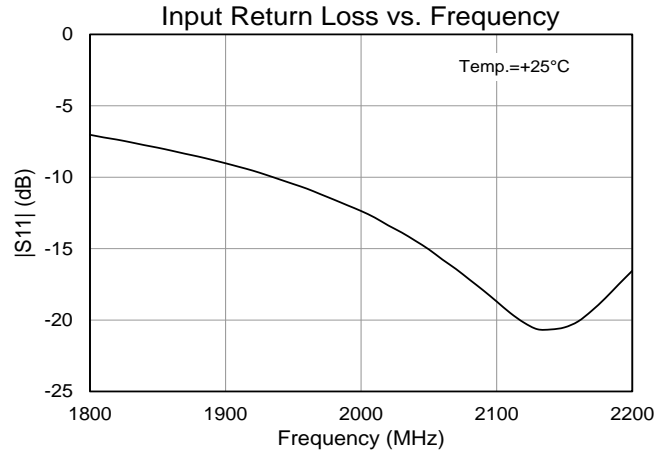
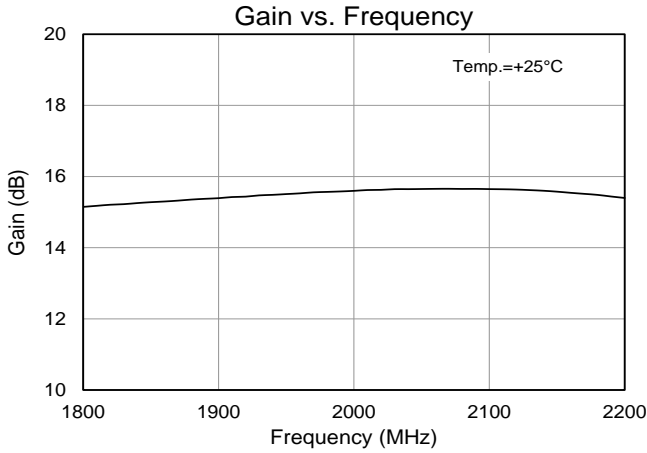

2110 – 2170 MHz Evaluation Board (TQP7M9102-PCB2140)

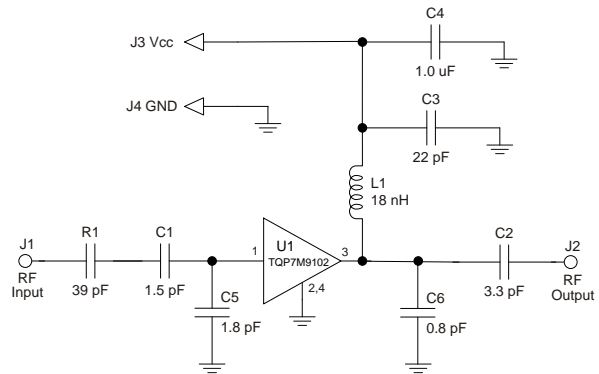
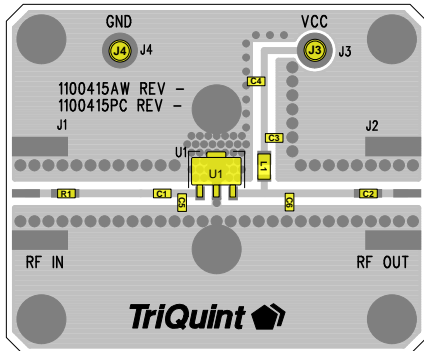

Notes:

1. See Evaluation Board PCB Information for material and stack up.
2. Components shown on the silkscreen but not on the schematic are not used.
3. The recommended component values are dependent upon the frequency of operation.
4. All components are of 0603 size unless stated on the schematic.
5. Critical component placement locations:
 - Distance from U1 Pin 1 (left edge) to C5 (right edge): 35 mils (3.9 deg. at 2140 MHz)
 - Distance from U1 Pin 1 (left edge) to C1 (right edge): 90 mils (9.9 deg. at 2140 MHz)
 - Distance from U1 Pin 3 (right edge) to C6 (left edge): 210 mils (23.2 deg. at 2140 MHz)

Bill of Material TQP7M9102-PCB2140

| Reference Des. | Value | Description | Manuf. | Part Number |
|----------------|--------|---|-----------|----------------|
| n/a | n/a | Printed Circuit Board | Qorvo | |
| U1 | n/a | TQP7M9102 Amplifier, SOT-89 pkg. | Qorvo | TQP7M9102 |
| R1 | 39 pF | Cap., Chip, 0603, +/-1%. 200V NPO/COG | various | |
| L1 | 18 nH | Inductor, 0805, Coilcraft CS Series | Coilcraft | 0805CS-180XJLB |
| C1 | 1.5 pF | Cap., Chip, 0603, +/-0.1pF. 200V. NPO/COG | various | 06032U1R5BAT2A |
| C2 | 3.3 pF | Cap., Chip, 0603, +/-0.1pF. 200V. NPO/COG | various | 06032U3R3BAT2A |
| C3 | 22 pF | Cap., Chip, 5%, 50V, NPO/COG | various | |
| C4 | 1.0 uF | Cap., Chip, 10%, 10V, X5R | various | |
| C5 | 1.8 pF | Cap., Chip, 0603, +/-0.1pF. 200V. NPO/COG | various | 06032U1R8BAT2A |
| C6 | 0.8 pF | Cap., Chip, 0603, +/-0.05pF, 50V | various | 06032U0R8BAT2A |

Typical Performance TQP7M9102-PCB2140

Test conditions unless otherwise noted: $V_{CC}=+5V$, $I_{CQ}=137\text{ mA}$ (typ.), $Temp=+25^\circ\text{C}$

| Parameter | Conditions | Typical Value | | | Units |
|------------------------------------|--|---------------|-------|-------|-------|
| Frequency | | 2110 | 2140 | 2170 | MHz |
| Gain | | 17.9 | 17.8 | 17.7 | dB |
| Input Return Loss | | 12 | 12 | 11 | dB |
| Output Return Loss | | 12 | 11 | 10 | dB |
| Output P1dB | | +27.8 | +27.6 | +27.4 | dBm |
| OIP3 | $P_{out}= +9\text{ dBm/ tone}$, $\Delta f=1\text{ MHz}$ | +43.6 | +43.5 | +43.6 | dBm |
| WCDMA Channel Power ⁽¹⁾ | -50 dBc ACLR | +18.5 | +18.4 | +18.3 | dBm |
| Noise Figure | | 3.8 | 3.9 | 4.0 | dB |

Notes:

1. ACLR Test set-up: 3GPP WCDMA, TM1+64 DPCH, +5 MHz offset, PAR = 10.2 dB at 0.01% Prob

Performance Plots TQP7M9102-PCB2140

Test conditions unless otherwise noted: $V_{CC}=+5V$, $I_{CQ}=137mA$ (typ.)

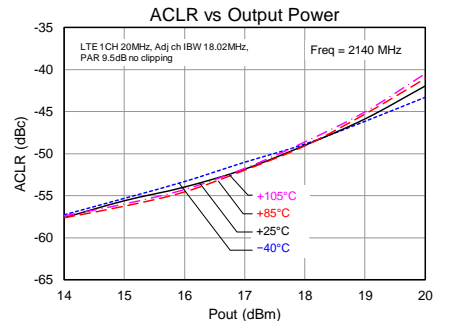
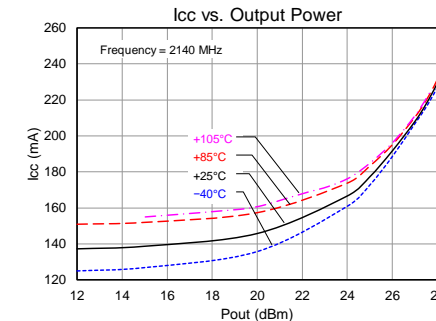
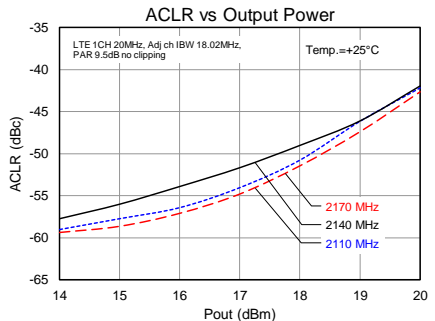
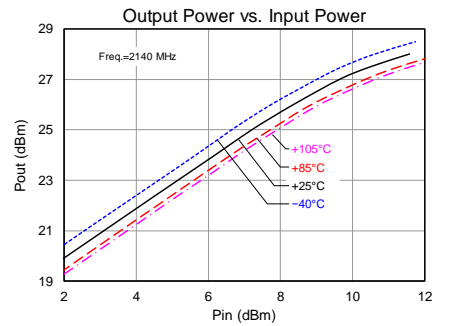
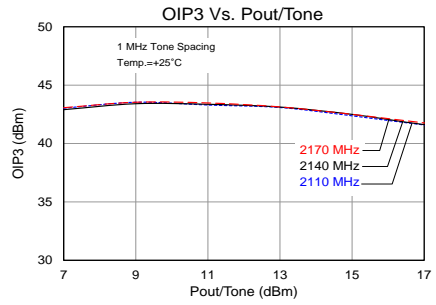
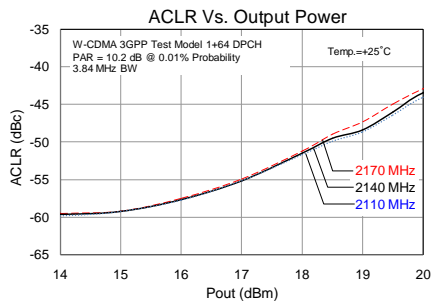
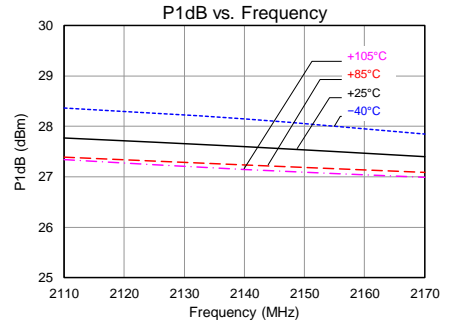
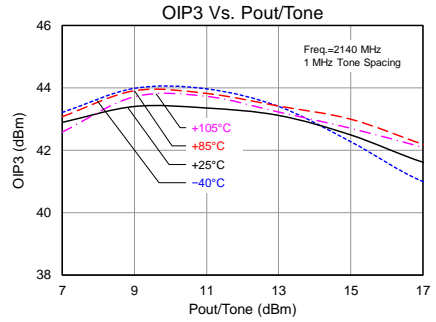
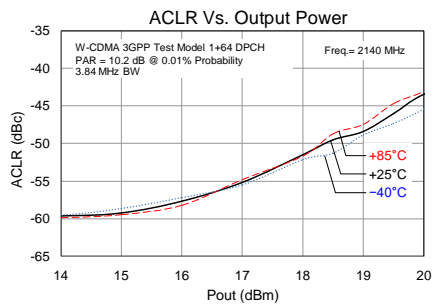
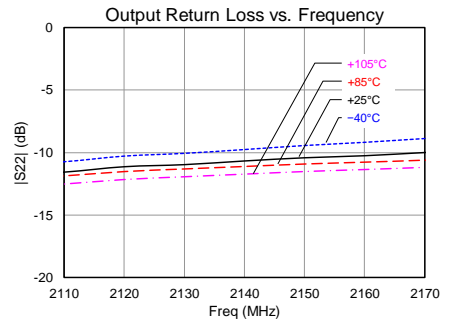
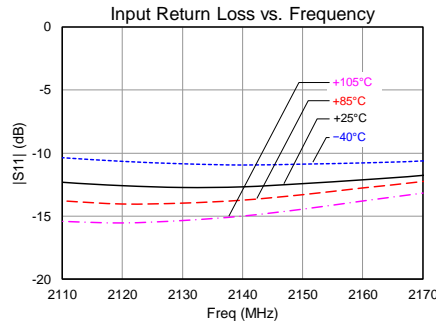
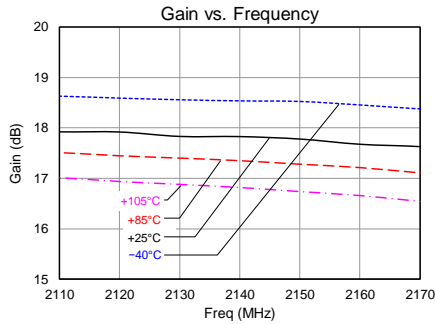

2300 – 2700 MHz Reference Design

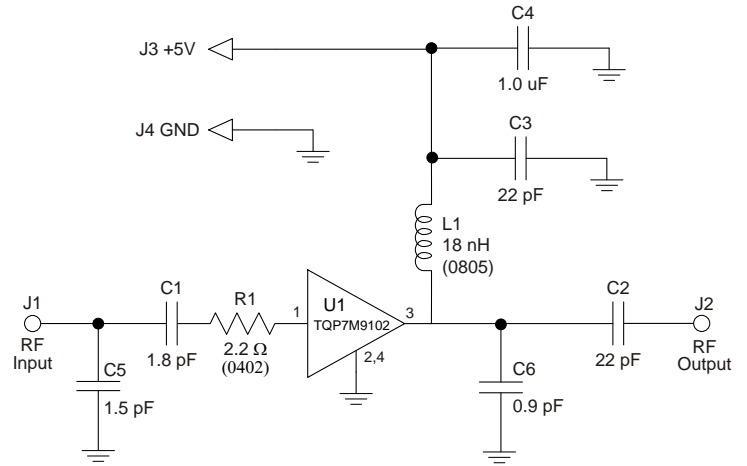
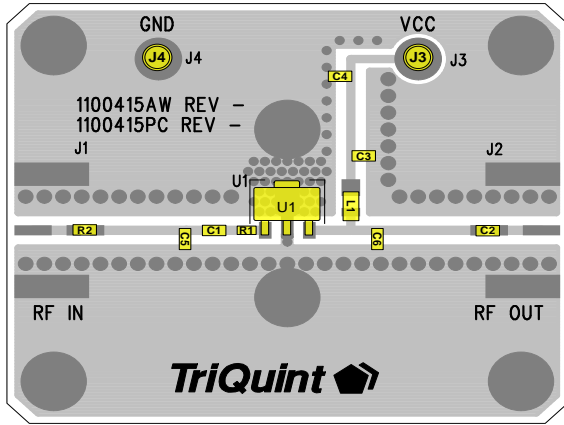

Notes:

1. See Evaluation Board PCB Information for material and stack up.
2. Components shown on the silkscreen but not on the schematic are not used.
3. 0 Ω resistors (R2) may be replaced with copper trace in the target application layout.
4. The recommended component values are dependent upon the frequency of operation.
5. All components are of 0603 size unless stated on the schematic.
6. Critical component placement locations:
 - Distance from U1 Pin 1 (left edge) to R1 (right edge): 10 mils
 - Distance from U1 Pin 1 (left edge) to C1 (right edge): 80 mils
 - Distance from U1 Pin 1 (left edge) to C5 (right edge): 235 mils
 - Distance from U1 Pin 3 (right edge) to C6 (left edge): 165 mils

Bill of Material 2300 – 2700 Reference Design

| Reference Des. | Value | Description | Manuf. | Part Number |
|----------------|--------------|-----------------------------------|-----------|----------------|
| n/a | n/a | Printed Circuit Board | Qorvo | |
| U1 | n/a | ½ W High Linearity Amplifier | Qorvo | TQP7M9102 |
| C1 | 1.8 pF | CAP, 0603, ± 0.05 pF, 50V, ACCU-P | AVX | 06035J1R8ABSTR |
| C5 | 1.5 pF | CAP, 0603, ± 0.05 pF, 50V, ACCU-P | AVX | 06035J1R5ABSTR |
| C2, C3 | 22 pF | CAP, 0603, 5%, 50V, NPO/COG | various | |
| C4 | 1.0 uF | CAP, 0603, 10%, X5R, 10V | various | |
| C6 | 0.9 pF | CAP, 0603 | AVX | 06035J0R9ABSTR |
| R1 | 2.2 Ω | RES, 0402 | various | |
| R2 | 0 Ω | RES, 0603, 5%, 1/16W, Chip | various | |
| L1 | 18 nH | IND, 0805, 5%, Ceramic | Coilcraft | 0805CS-180XJL |

Typical Performance 2300 – 2700 Reference Design

Test conditions unless otherwise noted: $V_{CC}=+5\text{ V}$, $I_{CQ}=137\text{ mA}$ (typ.), $Temp.=+25\text{ }^{\circ}\text{C}$

| Parameter | Conditions | Typical Value | | | Units |
|--------------------|---|---------------|-------|-------|-------|
| | | 2300 | 2500 | 2700 | |
| Frequency | | 2300 | 2500 | 2700 | MHz |
| Gain | | 13.8 | 14.7 | 13.6 | dB |
| Input Return Loss | | 5.5 | 13.3 | 7.9 | dB |
| Output Return Loss | | 12.6 | 12 | 10.6 | dB |
| Output P1dB | | +27.7 | +27.8 | +27.1 | dBm |
| OIP3 | $P_{out}= +9\text{ dBm} / \text{Tone}, \Delta f = 1\text{ MHz}$ | +43.8 | +44.0 | +45.9 | dBm |

Performance Plots 2300 – 2700 Reference Design

Test conditions unless otherwise noted: $V_{CC}=+5\text{ V}$, $I_{CQ}=137\text{ mA}$ (typ.), $Temp.=+25\text{ }^{\circ}\text{C}$

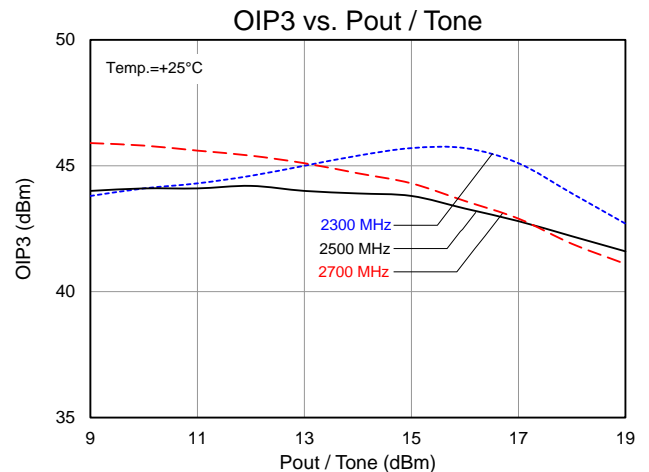
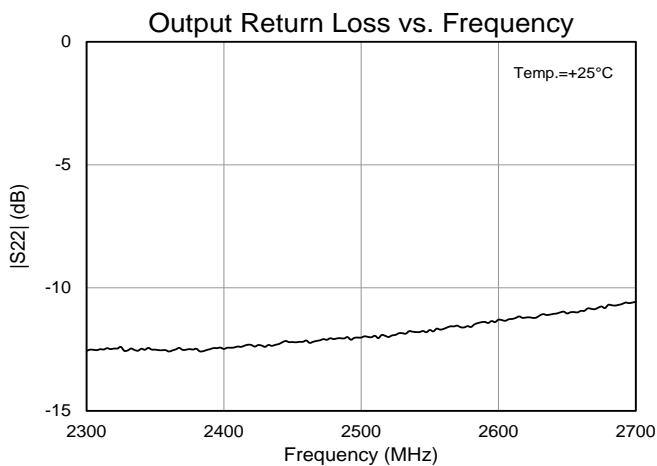
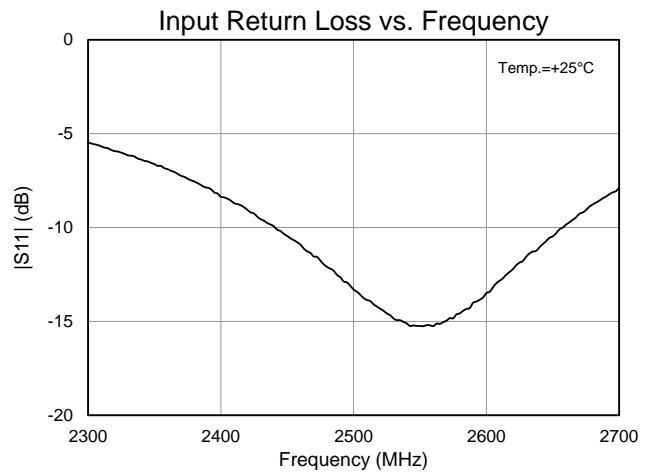
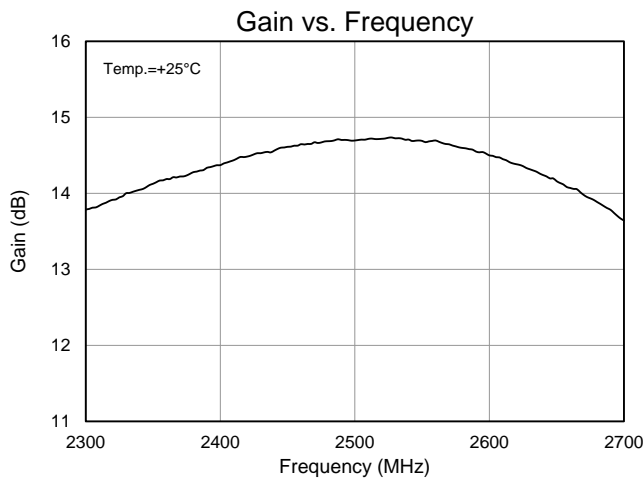

2.5 – 2.7 GHz Evaluation Board (TQP7M9102-PCB2600)

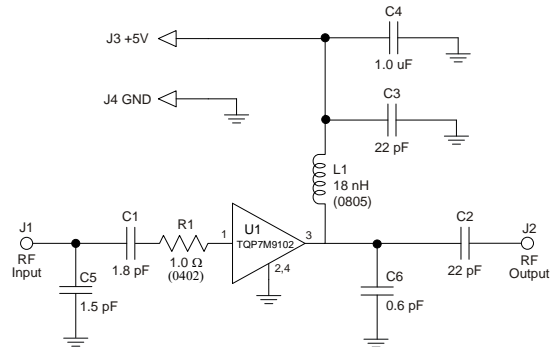
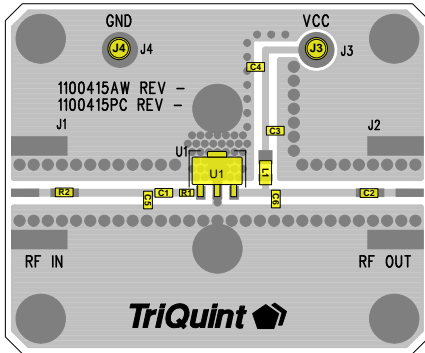

Notes:

1. See Evaluation Board PCB Information for material and stack up.
2. Components shown on the silkscreen but not on the schematic are not used.
3. 0 Ω resistors (R2) may be replaced with copper trace in the target application layout.
4. The recommended component values are dependent upon the frequency of operation.
5. All components are of 0603 size unless stated on the schematic.
6. Critical component placement locations:
 - Distance from U1 Pin 1 (left edge) to R1 (right edge): 13 mils
 - Distance from U1 Pin 1 (left edge) to C1 (right edge): 70 mils
 - Distance from U1 Pin 1 (left edge) to C5 (right edge): 148 mils
 - Distance from U1 Pin 3 (right edge) to C6 (left edge): 78 mils

Bill of Material TQP7M9102-PCB2600

| Reference Des. | Value | Description | Manuf. | Part Number |
|----------------|--------|-----------------------------------|-----------|----------------|
| n/a | n/a | Printed Circuit Board | Qorvo | |
| U1 | n/a | ½ W High Linearity Amplifier | Qorvo | TQP7M9102 |
| C1 | 1.8 pF | CAP, 0603, ± 0.05 pF, 50V, ACCU-P | AVX | 06035J1R8ABSTR |
| C5 | 1.5 pF | CAP, 0603, ± 0.05 pF, 50V, ACCU-P | AVX | 06035J1R5ABSTR |
| C2, C3 | 22 pF | CAP, 0603, 5%, 50V, NPO/COG | various | |
| C4 | 1.0 uF | CAP, 0603, 10%, X5R, 10V | various | |
| C6 | 0.6 pF | CAP, 0603, ± 0.05 pF, 50V, ACCU-P | AVX | 06035J0R6ABSTR |
| R1 | 1.0 Ω | RES, 0402, 1%, 1/16W. CHIP. | various | |
| R2 | 0 Ω | RES, 0603, 5%, 1/16W, Chip | various | |
| L1 | 18 nH | IND, 0805, 5%, Ceramic | Coilcraft | 0805CS-180XJL |

Typical Performance TQP7M9102-PCB2600

Test conditions unless otherwise noted: $V_{CC}=+5\text{ V}$, $I_{CQ}=137\text{ mA}$ (typ.), $\text{Temp.}=+25\text{ }^\circ\text{C}$

| Parameter | Conditions | Typical Value | | | Units |
|------------------------------------|---|---------------|-------|-------|-------|
| Frequency | | 2500 | 2600 | 2700 | MHz |
| Gain | | 14.3 | 14.5 | 14.1 | dB |
| Input Return Loss | | 8.5 | 14.5 | 12 | dB |
| Output Return Loss | | 8.5 | 8 | 7.5 | dB |
| Output P1dB | | +28.0 | +28.0 | +28.0 | dBm |
| OIP3 | $P_{out}= +11\text{ dBm/ tone}$, $\Delta f=1\text{ MHz}$ | +44.0 | +43.7 | +43.0 | dBm |
| WCDMA Channel Power ⁽¹⁾ | -50 dBc ACLR | +17.5 | +17.5 | +17.5 | dBm |

Notes:

1. ACLR Test set-up: 3GPP WCDMA, TM1+64 DPCH, +5 MHz offset, PAR = 10.2 dB at 0.01% Prob.

Performance Plots TQP7M9102-PCB2600

Test conditions unless otherwise noted: $V_{CC}=+5V$, $I_{CQ}=137\text{ mA}$ (typ.), Temp.=+25 °C

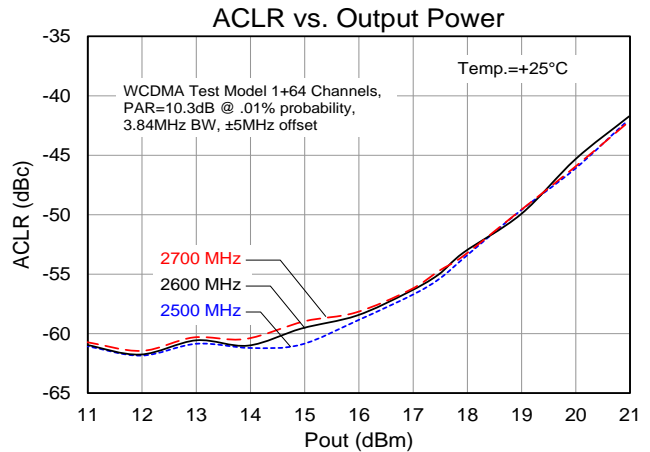
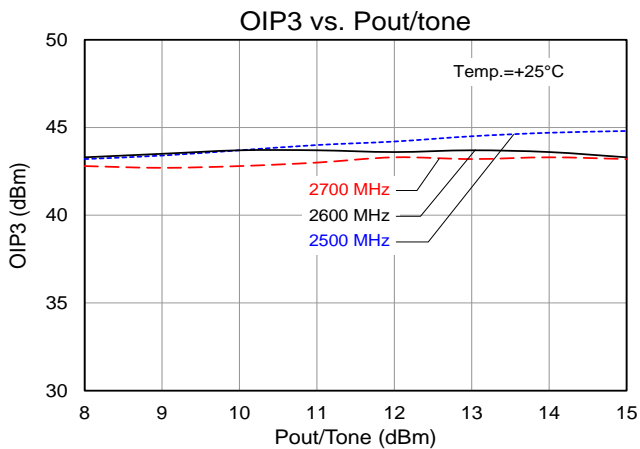
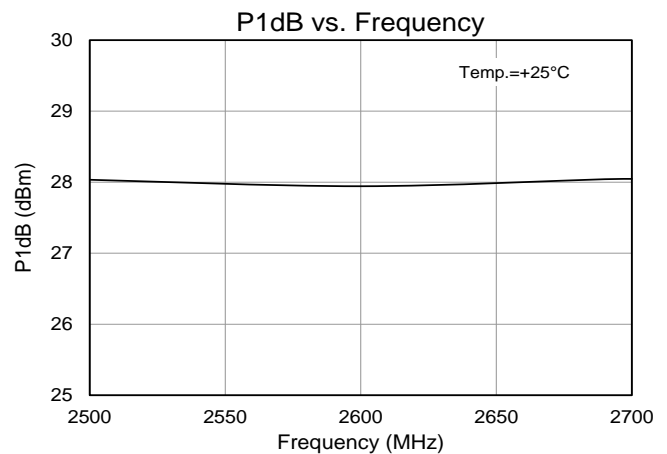
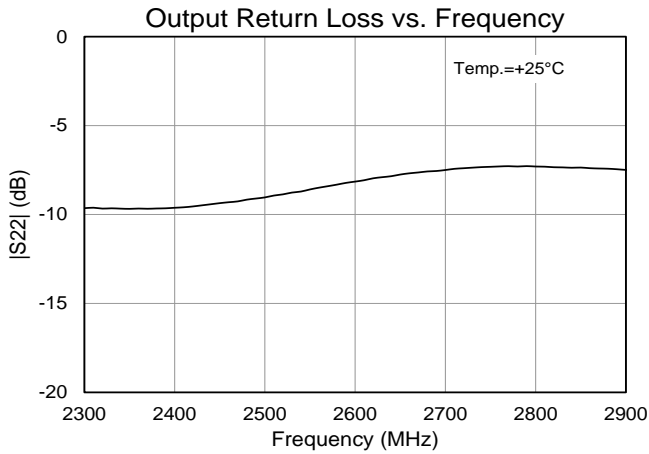
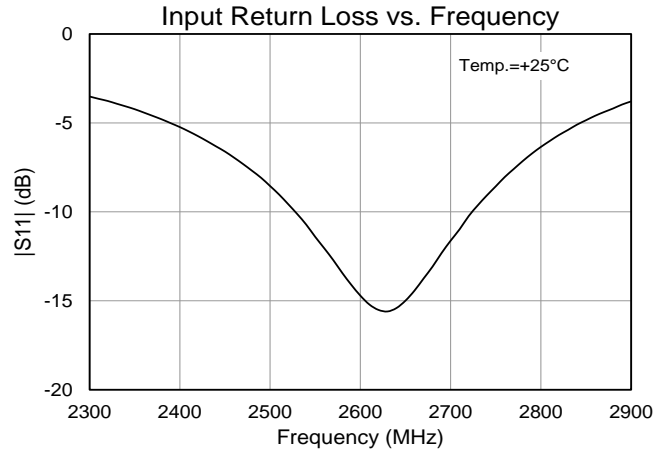
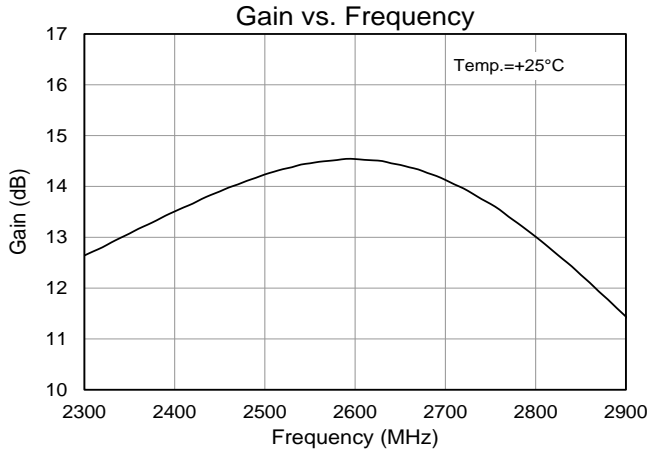

3400 – 3600 MHz Reference Design

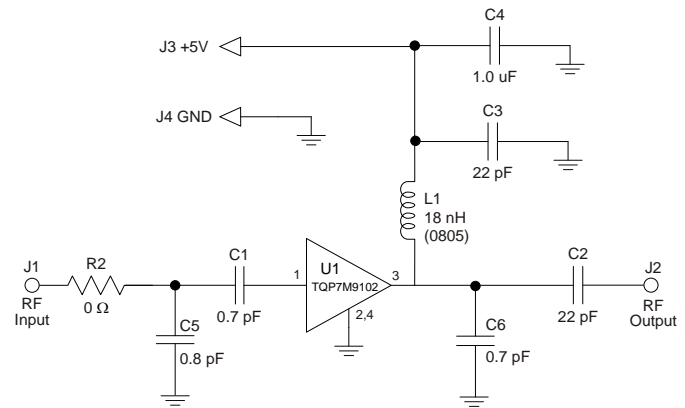
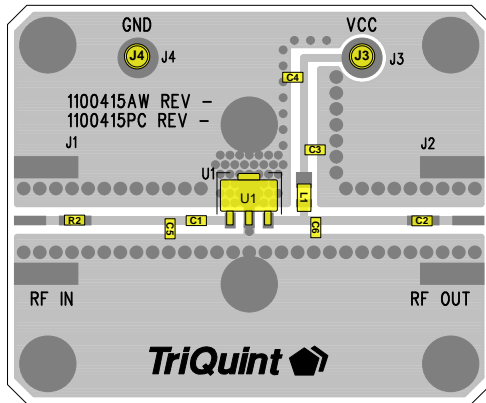

Notes:

7. See Evaluation Board PCB Information for material and stack up.
8. Components shown on the silkscreen but not on the schematic are not used.
9. 0 Ω resistors (R2) may be replaced with copper trace in the target application layout.
10. The recommended component values are dependent upon the frequency of operation.
11. All components are of 0603 size unless stated on the schematic.
12. Critical component placement locations:
 - Distance from U1 Pin 1 (left edge) to C1 (right edge): 87 mils
 - Distance from U1 Pin 1 (left edge) to C5 (right edge): 210 mils
 - Distance from U1 Pin 3 (right edge) to C6 (left edge): 105 mils

Bill of Material 3400 – 3600 MHz Reference Design

| Reference Des. | Value | Description | Manuf. | Part Number |
|----------------|------------|---|-----------|----------------|
| n/a | n/a | Printed Circuit Board | Qorvo | |
| U1 | n/a | 0.25 W High Linearity Amplifier | Qorvo | TQP7M9102 |
| R2 | 0 Ω | RES , 0603, 5PCT. 1/16W. CHIP | various | |
| C1 , C6 | 0.7 pF | CAP, 0603, \pm 0.1 pF, 50V | various | |
| C5 | 0.8 pF | CAP, 0603, \pm 0.1 pF, 50V | various | |
| C2 , C3 | 22 pF | CAP, 0603, 5%, 50V, NPO/COG | various | |
| C4 | 1.0 uF | CAP, 0603, 10%, X5R , 10V | various | |
| L1 | 18 nH | Inductor, 0805, 5%, Coilcraft CS series | Coilcraft | 0805CS-180XJLB |

Typical Performance 3400 – 3600 MHz Reference Design

Test conditions unless otherwise noted: $V_{CC}=+5V$, $I_{CQ}=137$ mA (typ.), Temp.=+25°C

| Parameter | Conditions | Typical Value | | | Units |
|------------------------------------|--------------------------------------|---------------|-------|-------|-------|
| | | 3400 | 3500 | 3600 | |
| Frequency | | 3400 | 3500 | 3600 | MHz |
| Gain | | 14.2 | 14.5 | 13.8 | dB |
| Input Return Loss | | 9 | 17 | 9 | dB |
| Output Return Loss | | 15 | 11 | 8 | dB |
| Output P1dB | | +27.1 | +26.7 | +26.2 | dBm |
| OIP3 | Pout= +11 dBm/tone, $\Delta f=1$ MHz | +43.3 | +44.6 | +44.6 | dBm |
| WCDMA Channel Power ⁽¹⁾ | -50 dBc ACLR | +18.0 | +17.5 | +17.0 | dBm |

Notes:

1. ACLR Test set-up: 3GPP WCDMA, TM1+64 DPCH, +5 MHz offset, PAR = 10.2 dB at 0.01% Prob

Performance Plots 3400 – 3600 MHz Reference Design

Test conditions unless otherwise noted: $V_{CC}=+5\text{ V}$, $I_{CQ}=137\text{ mA (typ.)}$, $\text{Temp.}=+25^\circ\text{C}$

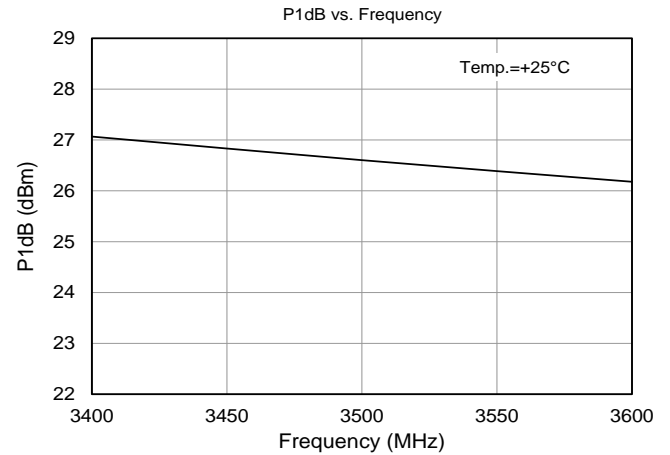
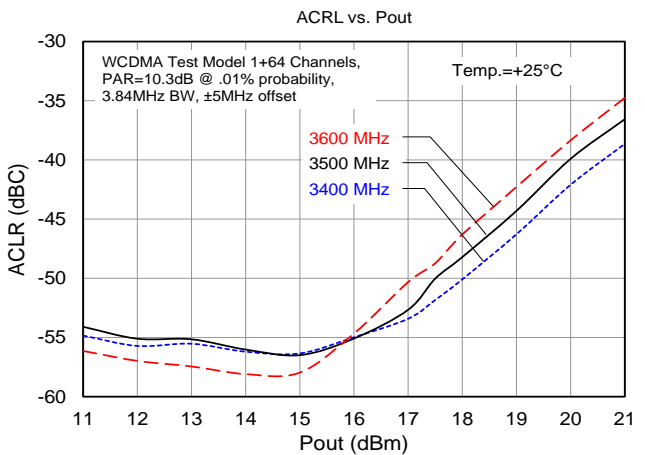
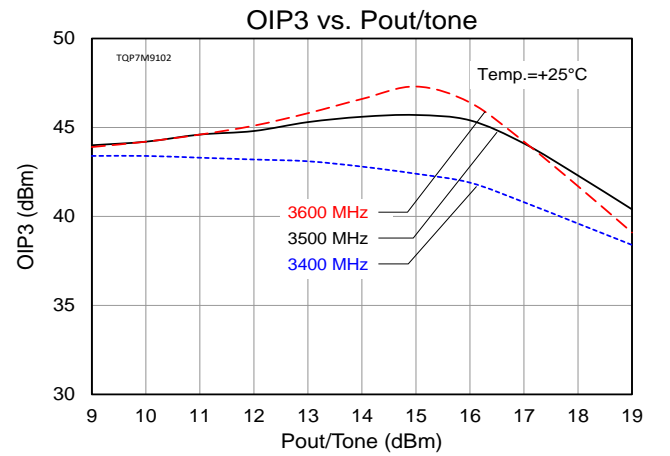
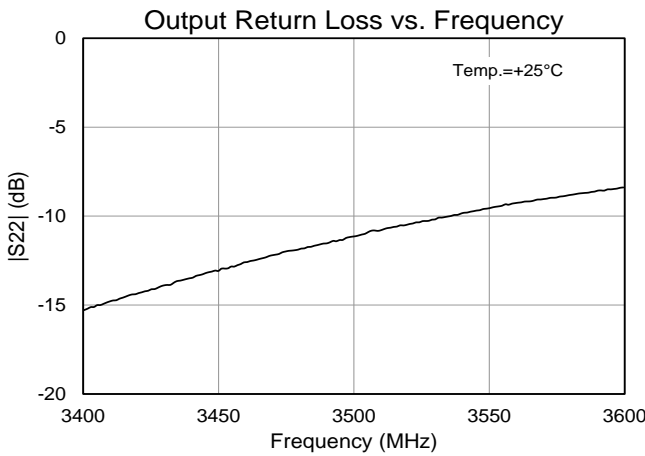
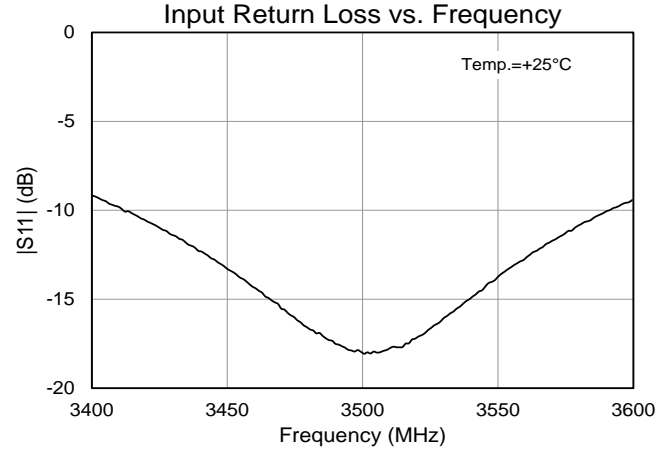
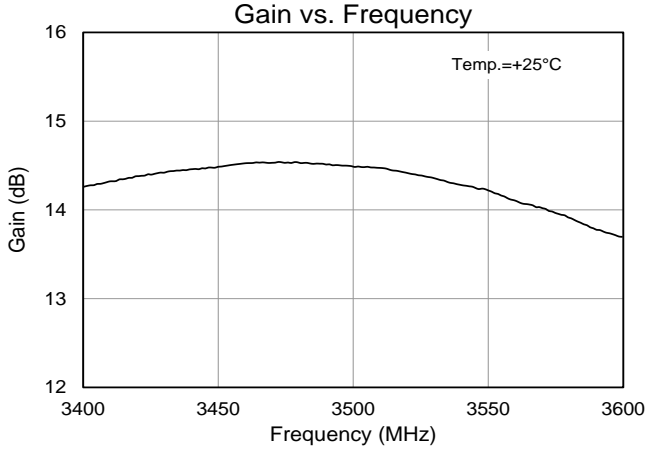

Application Note 1.8-2.2 GHz (1/2 Watt - 1 Watt) Tunable Reference Design

This application note describes the ability to take the TQP7M9102 1.8-2.2 GHz design and tune it from 1/2 Watt to 1 Watt simply by changing the output match (one component). By use of Load-Pull data we were able to see the capability of this part to be tuned from +27 dBm P1dB to +30 dBm by trading off OIP3 performance. This gives the end user the option to run the TQP7M9102 as a 1 Watt device over a wide frequency band.

Below are the different Reference Design options which show the performance trade-offs between P1dB and OIP3 by changing the value and placement of C6.

Evaluation Board

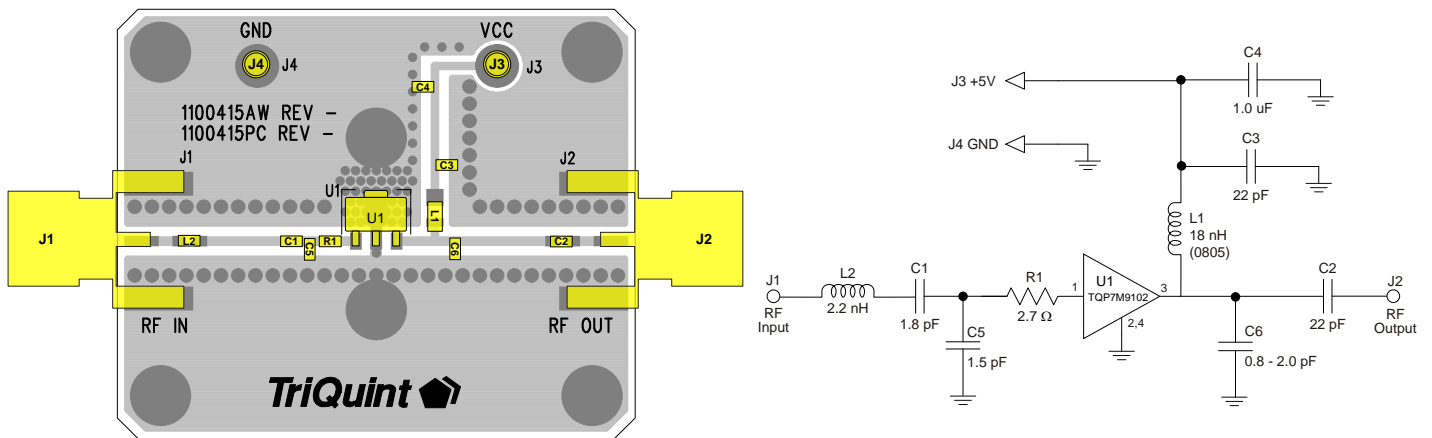

Notes:

1. All components are of 0603 size unless stated on the schematic.
2. The recommended component values are dependent upon the frequency of operation.
3. Critical component placement locations:
 - Distance between U1 Pin 1 Pad to R1 (right edge): 10 mil
 - Distance between U1 Pin 1 Pad to C1 (right edge): 110 mil
 - Distance between U1 Pin 1 Pad to C5 (right edge): 65 mil
 - Distance between U1 Pin 3 Pad to C6 (left edge): see below:

Component Placement

| Option | P1dB | C6 Value (pF) | Line Length (mils) | Electrical Length at 2 GHz (degrees) |
|--------|------|---------------|--------------------|--------------------------------------|
| 1 | 30.0 | 2.0 | 145 | 15.0 |
| 2 | 29.0 | 1.8 | 170 | 17.6 |
| 3 | 28.0 | 1.2 | 230 | 23.8 |
| 4 | 27.0 | 0.8 | 290 | 30.0 |

Performance Plots 1.8-2.2 GHz (1/2 Watt - 1 Watt) Tunable Reference Design

Test conditions unless otherwise noted: $V_{CC}=+5\text{ V}$, $I_{CQ}=137\text{ mA}$ (typ.), $Temp.=+25^{\circ}\text{C}$

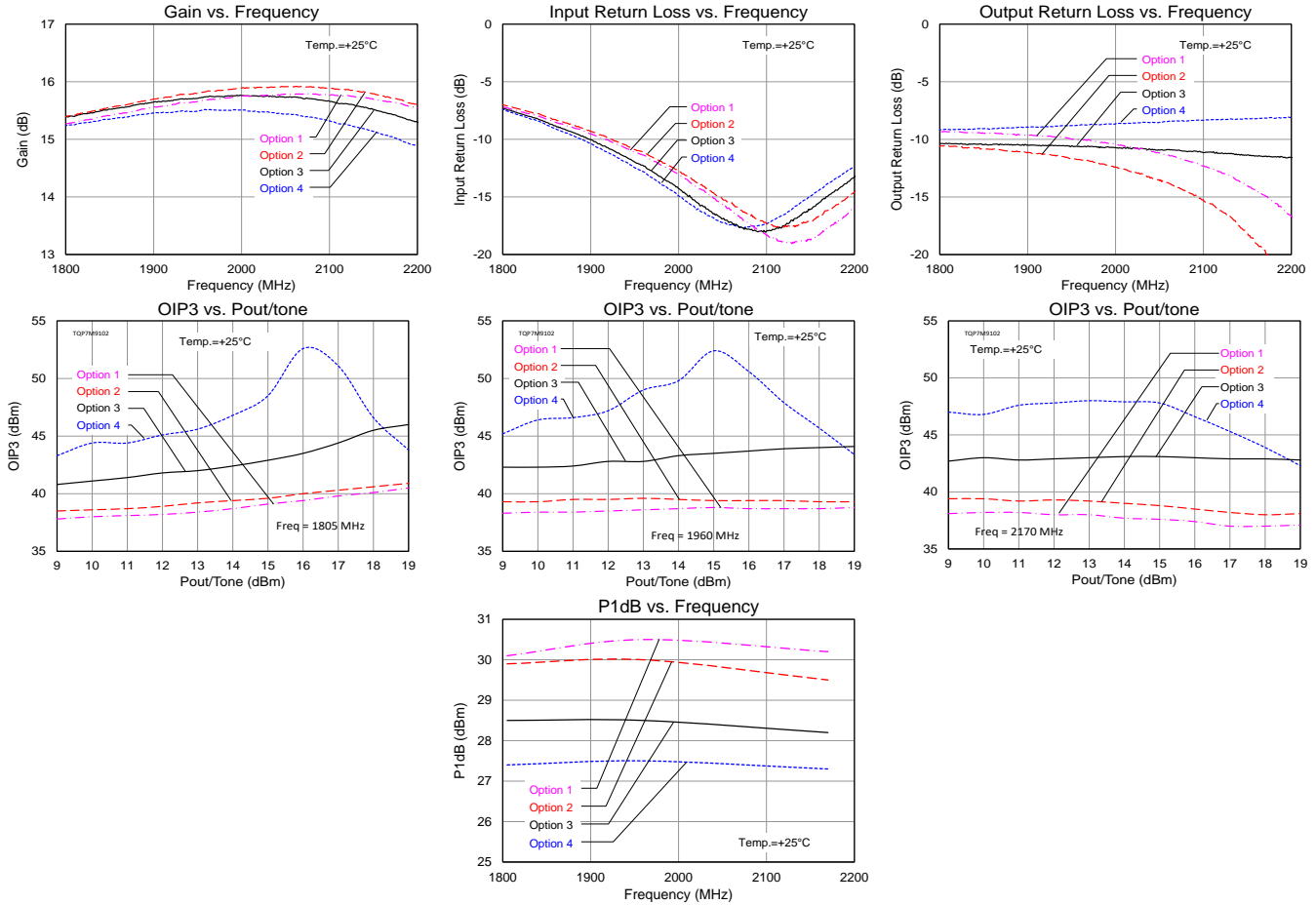

Pin Configuration and Description

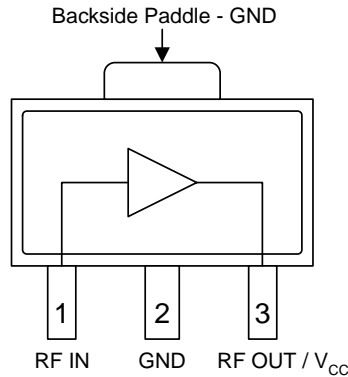

| Pin No. | Label | Description |
|--------------------|------------------------|--|
| 1 | RF IN | RF input. External DC Block required. Requires conjugate match for optimal performance. |
| 2, Backside Paddle | GND | RF/DC ground. Use recommended via pattern to minimize inductance and thermal resistance. See PCB Mounting Pattern for suggested footprint. |
| 3 | RF OUT/V _{CC} | RF output, matched to 50 ohms. External DC Block and bias voltage required. |

Evaluation Board PCB Information

PC Board Layout

PCB Material (stackup):

- 1 oz. Cu top layer
- 0.014 inch Nelco N-4000-13, $\epsilon_r=3.7$
- 1 oz. Cu MIDDLE layer 1
- Core Nelco N-4000-13
- 1 oz. Cu middle layer 2
- 0.014 inch Nelco N-4000-13
- 1 oz. Cu bottom layer
- Finished board thickness is 0.062±.006

50 ohm line dimensions: width = .028", spacing = .028".

The pad pattern shown has been developed and tested for optimized assembly at Qorvo. The PCB land pattern has been developed to accommodate lead and package tolerances. Since surface mount processes vary from supplier to supplier, careful process development is recommended.

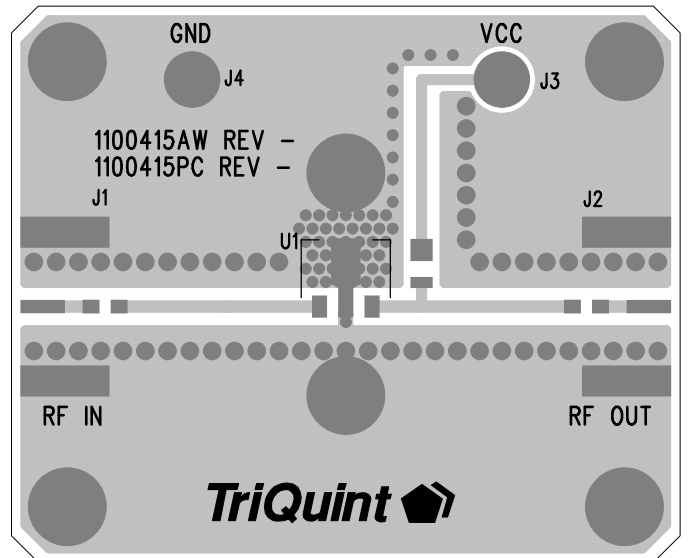

Package Marking and Dimensions

Package Marking

Product ID:
7M9102

Trace Code:
XXXX

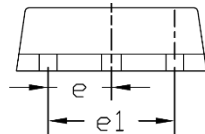
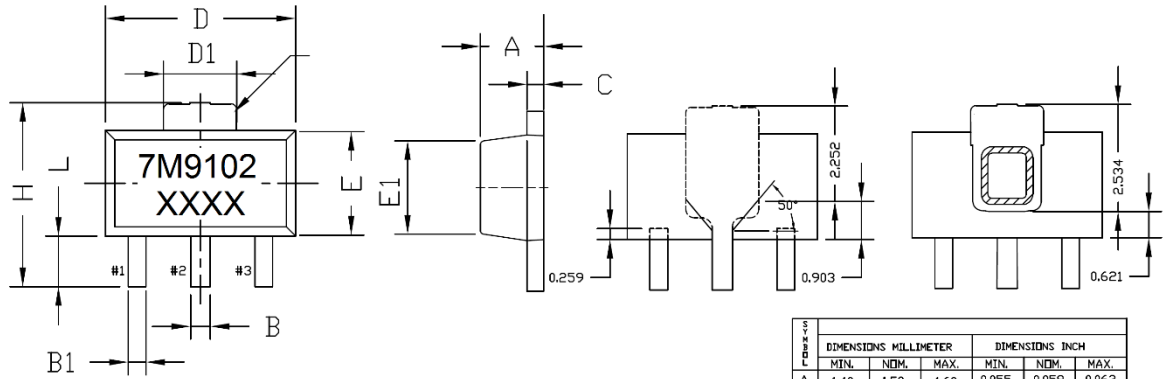

NOTES :
1. DIMENSIONING & TOLERANCING PER ANSI.Y14.5M-1982
2. CONTROLLING DIMENSION : MILLIMETER CONVERTED INCH
ARE NOT NECESSARILY EXACT.
3. DIMENSION B1, 2 PLACES.

| PARAMETER | DIMENSIONS MILLIMETER | | | DIMENSIONS INCH | | |
|-----------|-----------------------|------|------|-----------------|-------|-------|
| | MIN. | NOM. | MAX. | MIN. | NOM. | MAX. |
| A | 1.40 | 1.50 | 1.60 | 0.055 | 0.059 | 0.063 |
| B | 0.42 | 0.49 | 0.56 | 0.017 | 0.019 | 0.022 |
| B1 | 0.36 | 0.42 | 0.44 | 0.014 | 0.016 | 0.019 |
| C | 0.35 | 0.40 | 0.43 | 0.014 | 0.016 | 0.017 |
| D | 4.39 | 4.50 | 4.60 | 0.173 | 0.177 | 0.181 |
| D1 | 1.40 | 1.62 | 1.83 | 0.055 | 0.062 | 0.072 |
| E | 2.29 | 2.44 | 2.60 | 0.090 | 0.098 | 0.102 |
| e | 1.77 | 2.03 | 2.29 | 0.070 | 0.074 | 0.090 |
| e | 1.50 BSC | | | 0.059 BSC | | |
| e1 | 3.00 BSC | | | 0.118 BSC | | |
| H | 3.84 | 4.04 | 4.25 | 0.151 | 0.155 | 0.167 |
| L | 0.74 | 0.97 | 1.20 | 0.029 | 0.041 | 0.047 |

Notes:

1. The terminal #1 identifier and terminal numbering conform to JESD 95-1 SPP-012.
2. Trace code up to 4 characters to be assigned by sub-contractor.

PCB Mounting Pattern

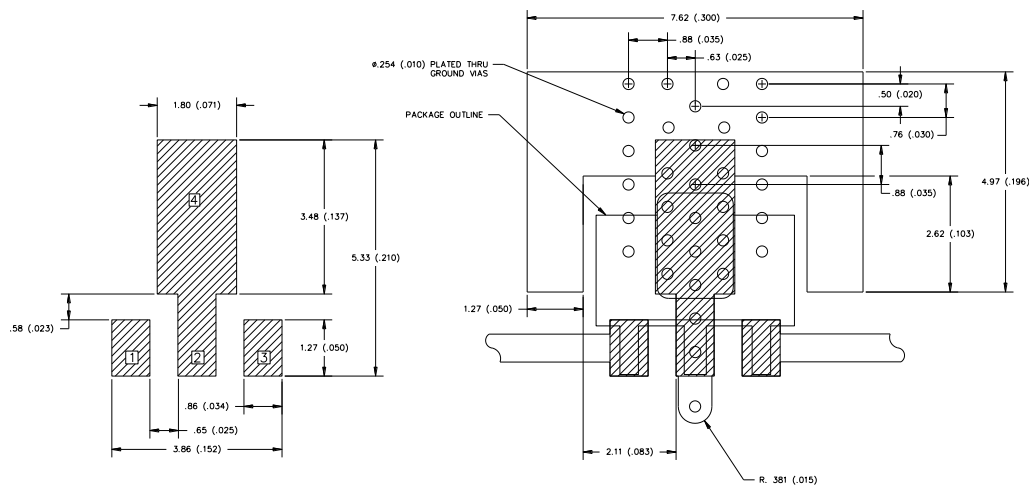

Notes:

1. All dimensions are in millimeters. Angles are in degrees.
2. Use 1 oz. copper minimum for top and bottom layer metal.
3. Via holes are required under the backside paddle of this device for proper RF/DC grounding and thermal dissipation.
4. Do not remove or minimize via hole structure in the PCB. Thermal and RF grounding is critical.
5. We recommend a 0.35mm (#80/.0135") diameter bit for drilling via holes and a final plated thru diameter of 0.25 mm (0.01").
6. Ensure good package backside paddle solder attach for best electrical and thermal performance.

Tape and Reel Information – Carrier and Cover Tape Dimensions

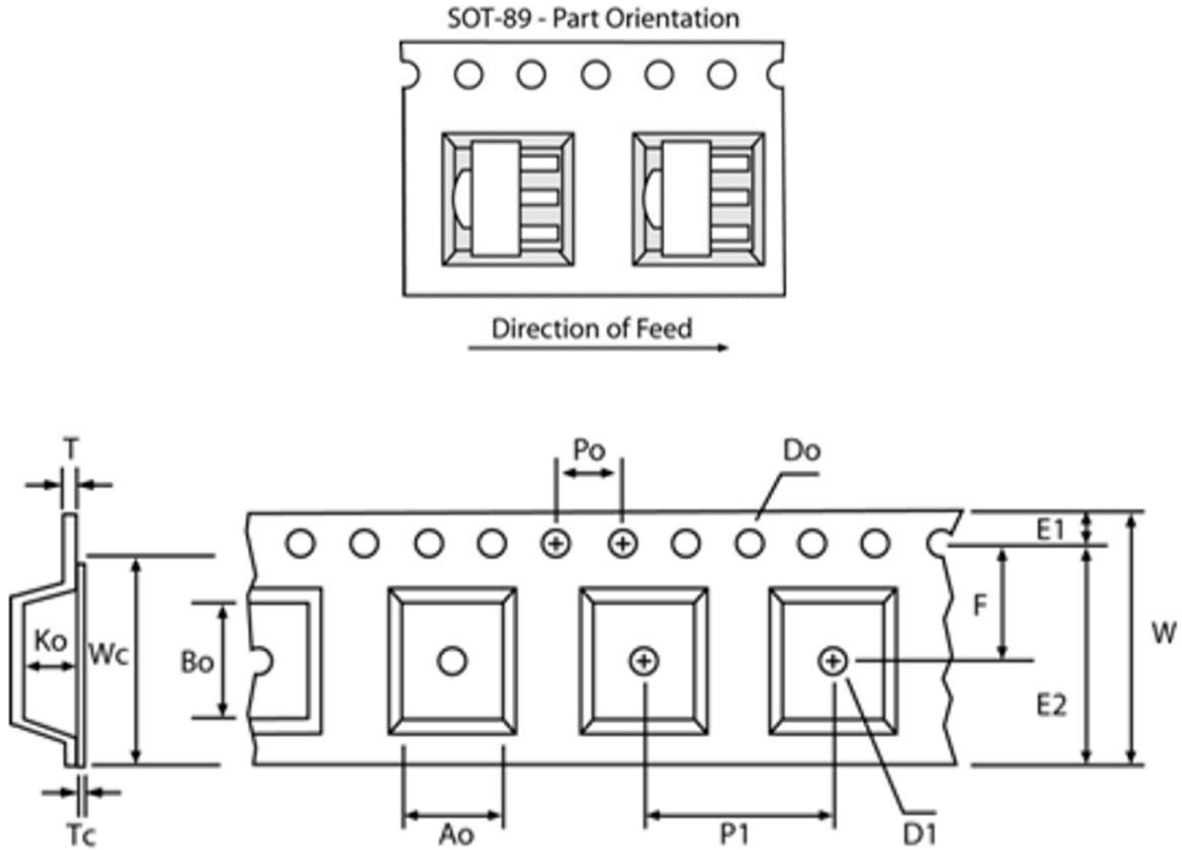

| Feature | Measure | Symbol | Size (in) | Size (mm) |
|---------------------|--|--------|-----------|-----------|
| Cavity | Length | A0 | 0.181 | 4.60 |
| | Width | B0 | 0.193 | 4.90 |
| | Depth | K0 | 0.075 | 1.90 |
| | Pitch | P1 | 0.315 | 8.00 |
| Centerline Distance | Cavity to Perforation - Length Direction | P2 | 0.079 | 2.00 |
| | Cavity to Perforation - Width Direction | F | 0.217 | 5.50 |
| Cover Tape | Width | C | 0.362 | 9.20 |
| Carrier Tape | Width | W | 0.472 | 12.0 |

Tape and Reel Information – Reel Dimensions (7")

Standard T/R size = 1,000 pieces on a 7" reel.

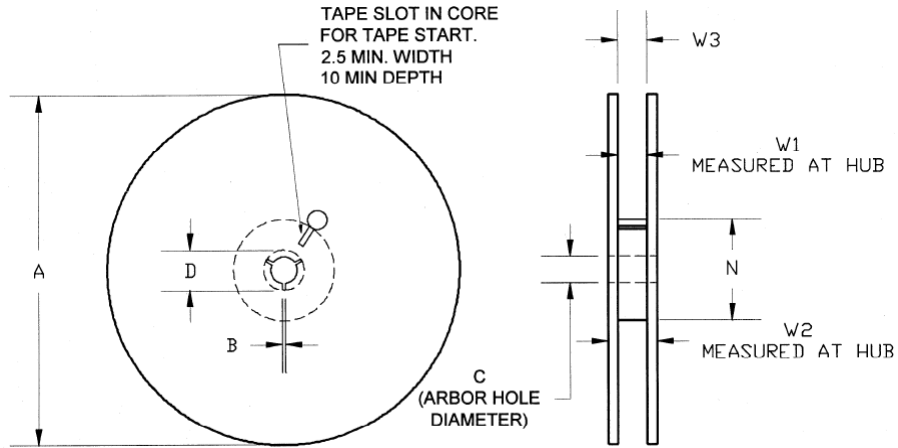

| Feature | Measure | Symbol | Size (in) | Size (mm) |
|---------|----------------------|--------|-----------|-----------|
| Flange | Diameter | A | 6.969 | 177.0 |
| | Thickness | W2 | 0.717 | 18.2 |
| | Space Between Flange | W1 | 0.504 | 12.8 |
| Hub | Outer Diameter | N | 2.283 | 58.0 |
| | Arbor Hole Diameter | C | 0.512 | 13.0 |
| | Key Slit Width | B | 0.079 | 2.0 |
| | Key Slit Diameter | D | 0.787 | 20.0 |

Tape and Reel Information – Tape Length and Label Placement

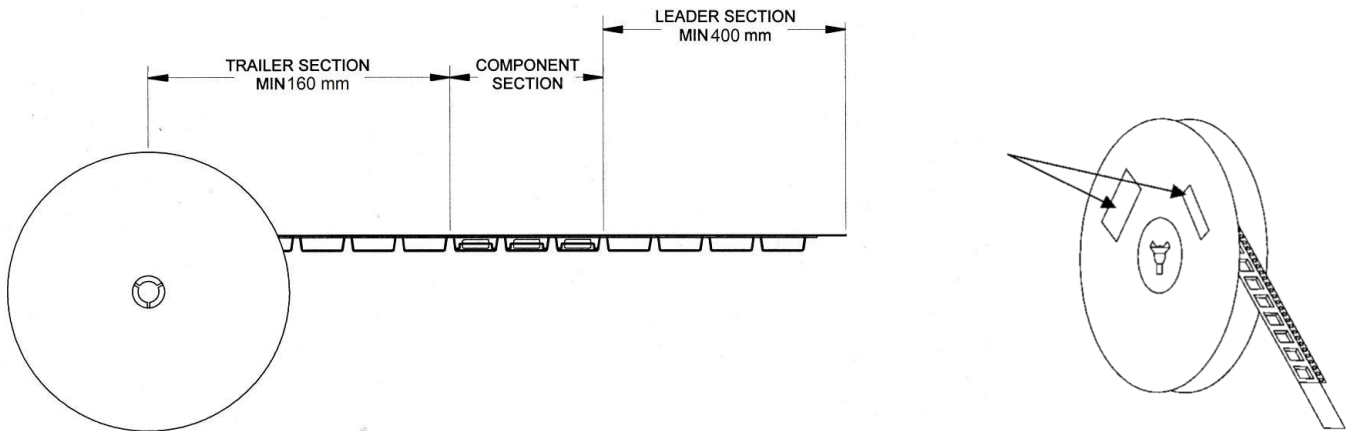

- Notes:
1. Empty part cavities at the trailing and leading ends are sealed with cover tape. See EIA 481-1-A.
 2. Labels are placed on the flange opposite the sprockets in the carrier tape.

Handling Precautions

| Parameter | Rating | Standard |
|----------------------------------|----------|--------------------------|
| ESD – Human Body Model (HBM) | Class 2 | ESDA / JEDEC JS-001-2014 |
| ESD – Charged Device Model (CDM) | Class C3 | ESDA / JEDEC JS-002-2014 |
| MSL – Moisture Sensitivity Level | Level 1 | IPC/JEDEC J-STD-020 |



Caution!
ESD-Sensitive Device

Solderability

Compatible with lead-free (260°C max. reflow temp.) soldering process.

Solder profiles available upon request.

Contact plating: Annealed Matte Tin

RoHS Compliance

This part is compliant with 2011/65/EU RoHS directive (Restrictions on the Use of Certain Hazardous Substances in Electrical and Electronic Equipment) as amended by Directive 2015/863/EU.

This product also has the following attributes:

- Lead Free
- Halogen Free (Chlorine, Bromine)
- Antimony Free
- TBBP-A (C₁₅H₁₂Br₄O₂) Free
- SVHC Free



Contact Information

For the latest specifications, additional product information, worldwide sales and distribution locations:

Web: www.qorvo.com

Tel: 1-844-890-8163

Email: customer.support@qorvo.com

Important Notice

The information contained herein is believed to be reliable; however, Qorvo makes no warranties regarding the information contained herein and assumes no responsibility or liability whatsoever for the use of the information contained herein. All information contained herein is subject to change without notice. Customers should obtain and verify the latest relevant information before placing orders for Qorvo products. The information contained herein or any use of such information does not grant, explicitly or implicitly, to any party any patent rights, licenses, or any other intellectual property rights, whether with regard to such information itself or anything described by such information. **THIS INFORMATION DOES NOT CONSTITUTE A WARRANTY WITH RESPECT TO THE PRODUCTS DESCRIBED HEREIN, AND QORVO HEREBY DISCLAIMS ANY AND ALL WARRANTIES WITH RESPECT TO SUCH PRODUCTS WHETHER EXPRESS OR IMPLIED BY LAW, COURSE OF DEALING, COURSE OF PERFORMANCE, USAGE OF TRADE OR OTHERWISE, INCLUDING THE IMPLIED WARRANTIES OF MERCHANTABILITY AND FITNESS FOR A PARTICULAR PURPOSE.**

Without limiting the generality of the foregoing, Qorvo products are not warranted or authorized for use as critical components in medical, life-saving, or life-sustaining applications, or other applications where a failure would reasonably be expected to cause severe personal injury or death.

Copyright 2020 © Qorvo, Inc. | Qorvo is a registered trademark of Qorvo, Inc.