

BiCMOS MIXER W/ INTEGRATED LO AMPLIFIER, 1.7 - 2.2 GHz



Typical Applications

The HMC785LP4E is Ideal for:

- Cellular/3G & LTE/WiMAX/4G
- Basestations & Repeaters
- GSM, CDMA & OFDM
- Transmitters and Receivers

Features

- High Input IP3: +38 dBm
- 8 dB Conversion Loss @ 0 dBm LO
- Optimized for Low Side LO Input
- Adjustable Supply Current
- 24 Lead 4x4mm SMT Package: 16mm²

Functional Diagram

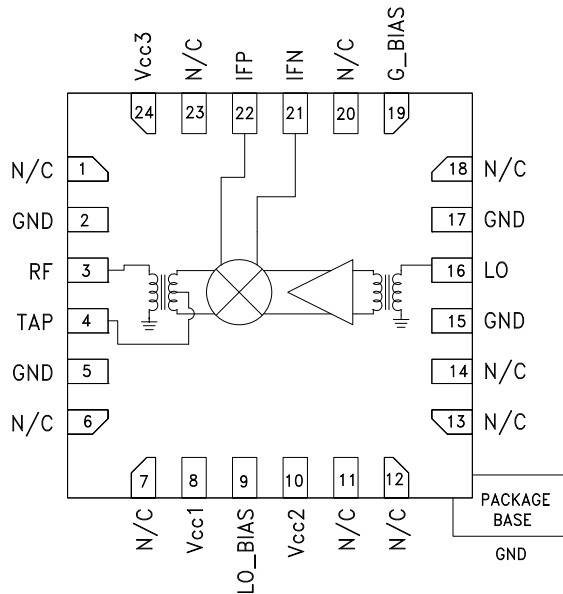

General Description

The HMC785LP4E is a high dynamic range passive MMIC mixer with integrated LO amplifier in a 4x4 SMT QFN package covering 1.7 to 2.2 GHz. Excellent input IP3 performance of +38 dBm for down conversion is provided for 3G & 4G GSM/CDMA applications at an LO drive of 0 dBm. With an input 1 dB compression of +26 dBm, the RF port will accept a wide range of input signal levels. Conversion loss is 8 dB typical. Up to 300 MHz IF frequency response will satisfy GSM/CDMA transmit or receive frequency plans. The HMC785LP4E is optimized for low side LO frequency plans for 1.7 - 2.2 GHz RF Band and is pin for pin compatible with the HMC685LP4E

Electrical Specifications,

$T_A = +25^\circ C$, LO = 0 dBm, V_{cc} = V_{cc1}, 2, 3 = +5V, G_{Bias} = +2.5V *

Parameter	Min.	Typ.	Max.	Units
Frequency Range, RF		1.7 - 2.2		GHz
Frequency Range, LO		1.5 - 2.2		GHz
Frequency Range, IF		50 - 300		MHz
Conversion Loss		8	10	dB
Noise Figure (SSB)		8		dB
IP3 (Input)		36		dBm
1 dB Compression (Input)		26		dBm
LO to RF Isolation	18	30		dB
LO to IF Isolation	18	25		dB
RF to IF Isolation	25	39		dB
LO Drive Input Level (Typical)		-6 to +6		dBm
Supply Current I _{cc} total		160	180	mA

* Unless otherwise noted all measurements performed as downconverter with low side LO & IF = 200 MHz.

BiCMOS MIXER W/ INTEGRATED LO AMPLIFIER, 1.7 - 2.2 GHz



Downconverter Performance

Conversion Gain vs. Temperature

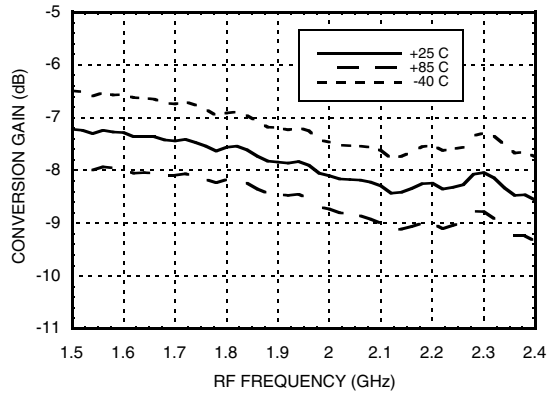

Conversion Gain vs. LO Drive

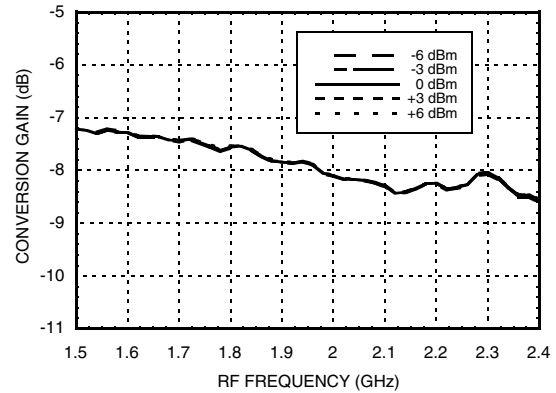

Conversion Gain vs. Icc

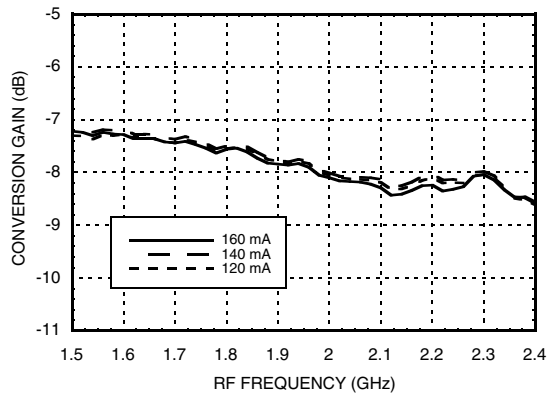

Conversion Gain vs. G_Bias Voltage

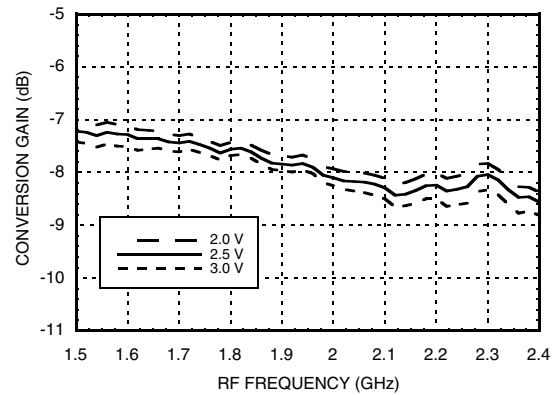

Conversion Gain vs. IF Frequency

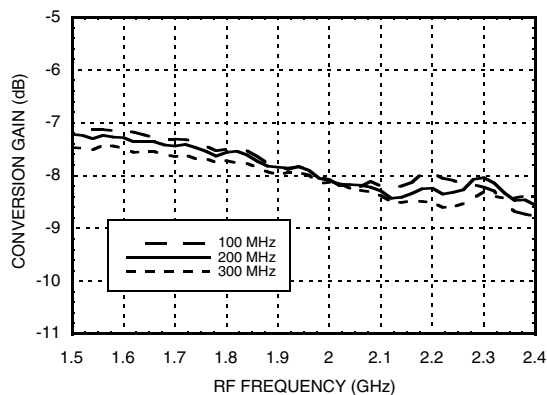

IF Bandwidth (LO = 1.7 GHz)

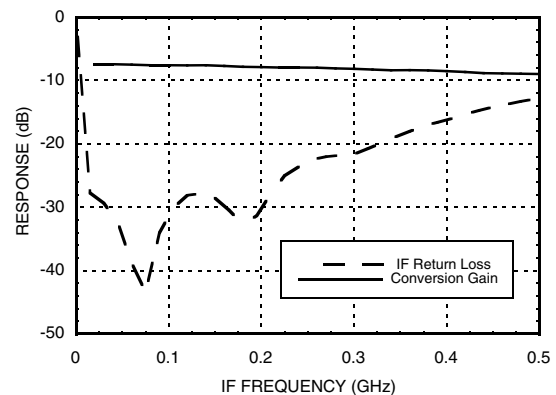

Information furnished by Analog Devices is believed to be accurate and reliable. However, no responsibility is assumed by Analog Devices for its use, nor for any infringements of patents or other rights of third parties that may result from its use. Specifications subject to change without notice. No license is granted by implication or otherwise under any patent or patent rights of Analog Devices. Trademarks and registered trademarks are the property of their respective owners.

For price, delivery, and to place orders: Analog Devices, Inc., One Technology Way, P.O. Box 9106, Norwood, MA 02062-9106 Phone: 781-329-4700 • Order online at www.analog.com Application Support: Phone: 1-800-ANALOG-D

BiCMOS MIXER W/ INTEGRATED LO AMPLIFIER, 1.7 - 2.2 GHz



Downconverter Performance

Input IP3 vs. Temperature [1]

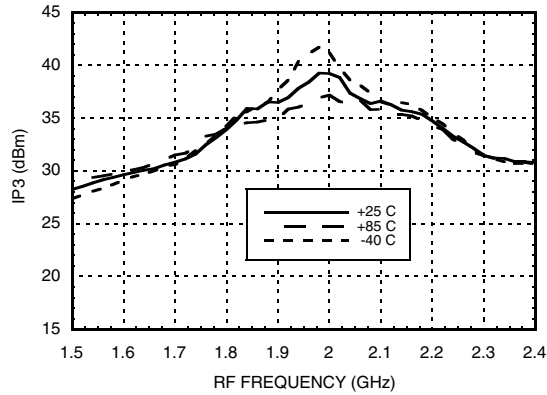

Input IP3 vs. LO Drive [1]

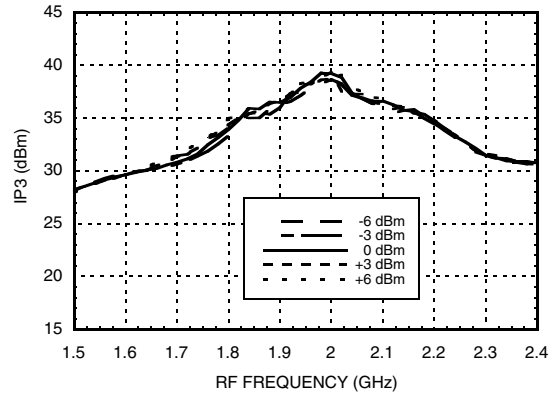

Input IP3 vs. Icc [1]

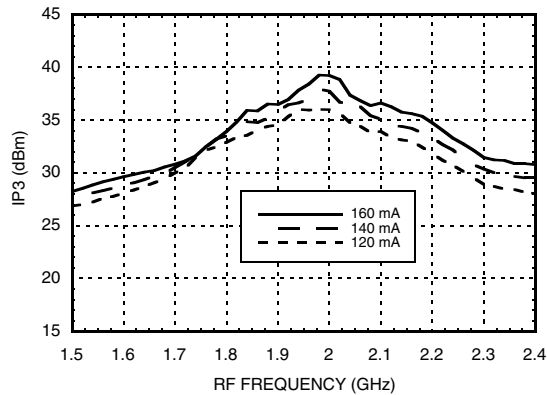

Input IP3 vs. G_Bias Voltage [1]

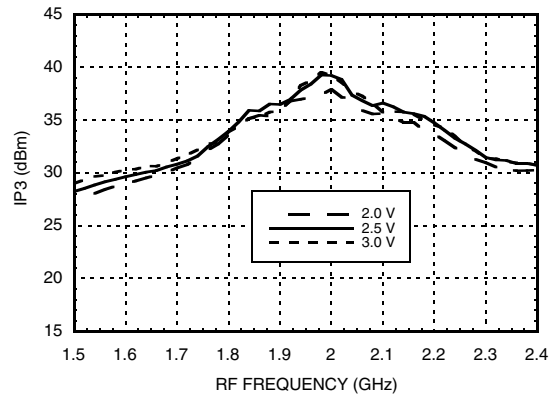

Input IP3 vs. IF Frequency [1]

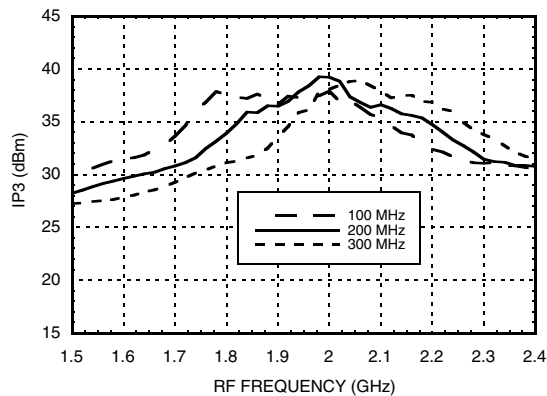

Input P1dB vs. Temperature

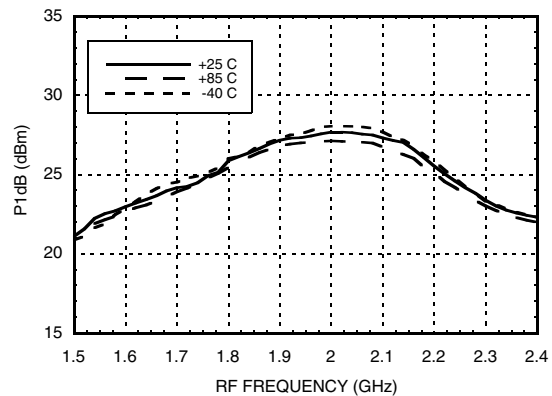

[1] Two-tone input power = +9 dBm each tone, 1 MHz spacing.

Information furnished by Analog Devices is believed to be accurate and reliable. However, no responsibility is assumed by Analog Devices for its use, nor for any infringements of patents or other rights of third parties that may result from its use. Specifications subject to change without notice. No license is granted by implication or otherwise under any patent or patent rights of Analog Devices. Trademarks and registered trademarks are the property of their respective owners.

For price, delivery, and to place orders: Analog Devices, Inc., One Technology Way, P.O. Box 9106, Norwood, MA 02062-9106 Phone: 781-329-4700 • Order online at www.analog.com Application Support: Phone: 1-800-ANALOG-D

BiCMOS MIXER W/ INTEGRATED LO AMPLIFIER, 1.7 - 2.2 GHz



Downconverter Performance

+2RF -2LO Response vs. Temperature [1]

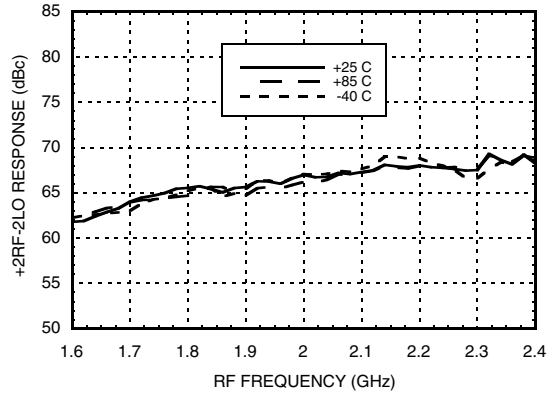

+2RF -2LO Response vs. LO Drive [1]

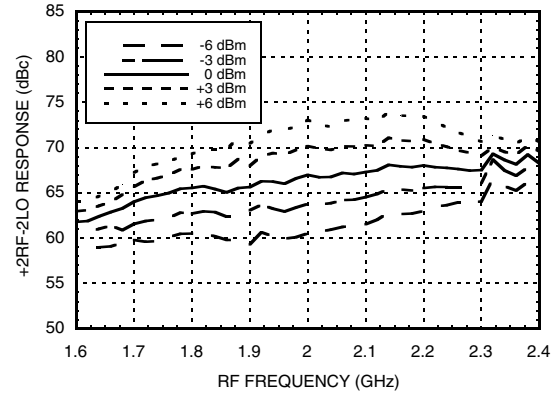

+3RF -3LO Response vs. Temperature [1]

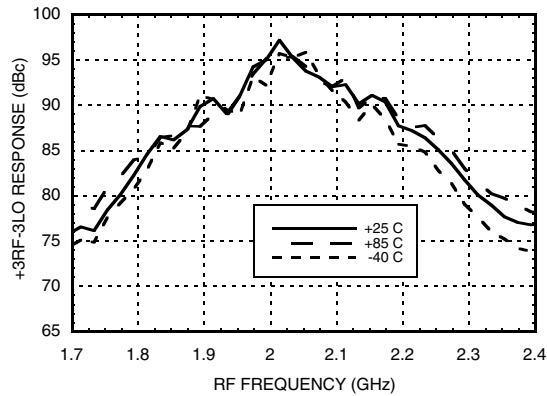

+3RF -3LO Response vs. LO Drive [1]

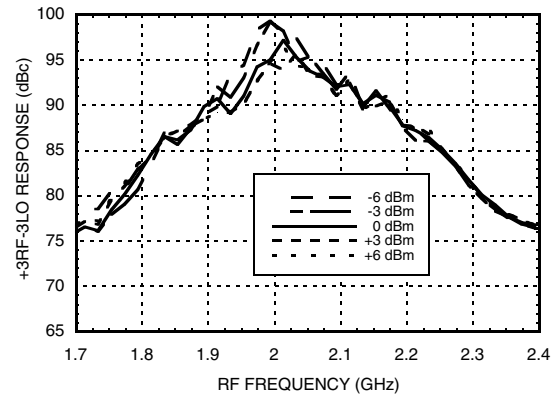

Return Loss

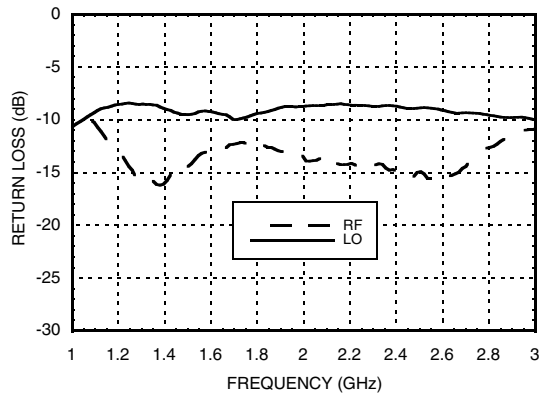

Isolation

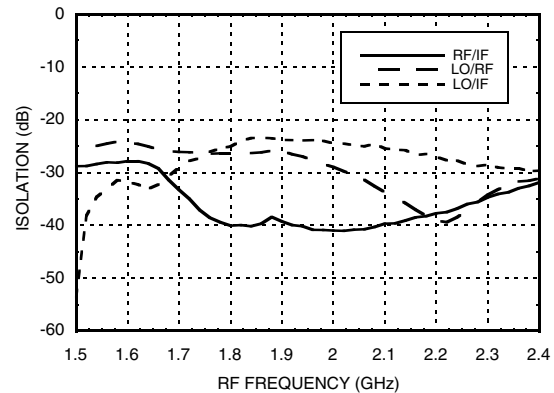

[1] Referenced to RF Input Power at 0 dBm

Information furnished by Analog Devices is believed to be accurate and reliable. However, no responsibility is assumed by Analog Devices for its use, nor for any infringements of patents or other rights of third parties that may result from its use. Specifications subject to change without notice. No license is granted by implication or otherwise under any patent or patent rights of Analog Devices. Trademarks and registered trademarks are the property of their respective owners.

For price, delivery, and to place orders: Analog Devices, Inc., One Technology Way, P.O. Box 9106, Norwood, MA 02062-9106 Phone: 781-329-4700 • Order online at www.analog.com Application Support: Phone: 1-800-ANALOG-D

BiCMOS MIXER W/ INTEGRATED LO AMPLIFIER, 1.7 - 2.2 GHz



Upconverter Performance [1]

Conversion Gain vs. Temperature

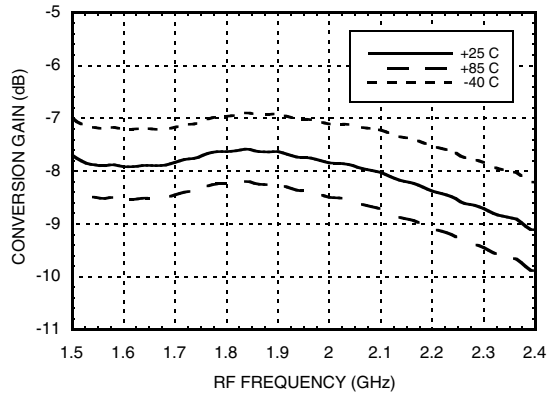

Conversion Gain vs. LO Drive

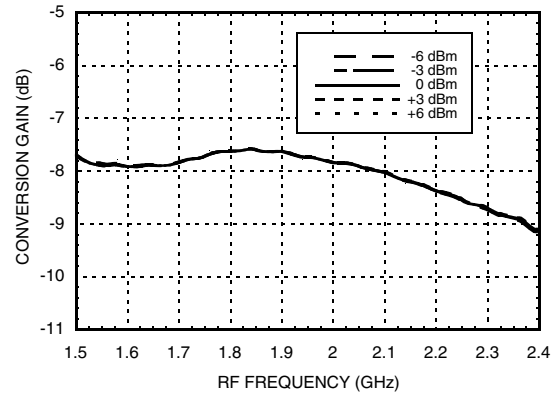

Conversion Gain vs. Icc

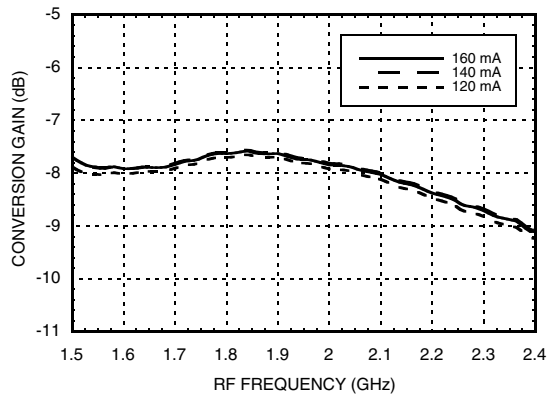

Conversion Gain vs. G_Bias Voltage

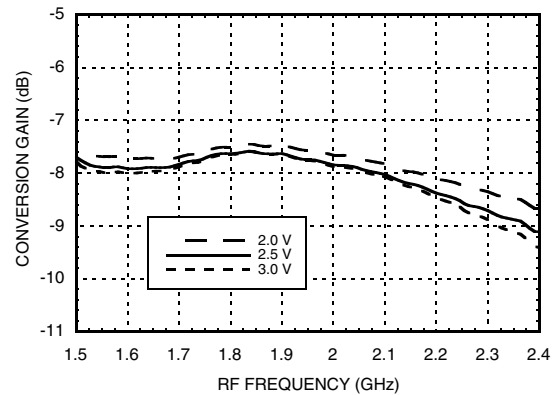

Conversion Gain vs. IF Frequency

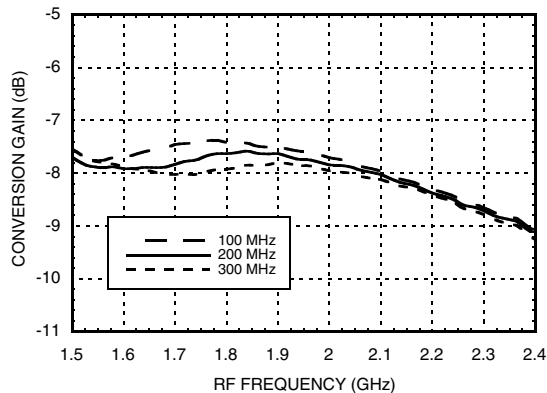

Return Loss

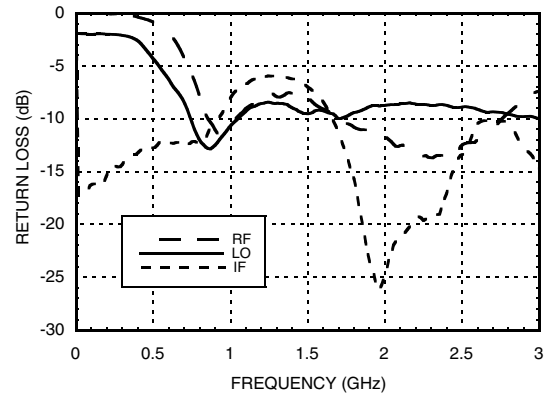

[1] See Upconverter Evaluation PCB and Schematic

Information furnished by Analog Devices is believed to be accurate and reliable. However, no responsibility is assumed by Analog Devices for its use, nor for any infringements of patents or other rights of third parties that may result from its use. Specifications subject to change without notice. No license is granted by implication or otherwise under any patent or patent rights of Analog Devices. Trademarks and registered trademarks are the property of their respective owners.

For price, delivery, and to place orders: Analog Devices, Inc., One Technology Way, P.O. Box 9106, Norwood, MA 02062-9106 Phone: 781-329-4700 • Order online at www.analog.com Application Support: Phone: 1-800-ANALOG-D

BiCMOS MIXER W/ INTEGRATED LO AMPLIFIER, 1.7 - 2.2 GHz



Upconverter Performance [1]

Input IP3 vs. Temperature [2]

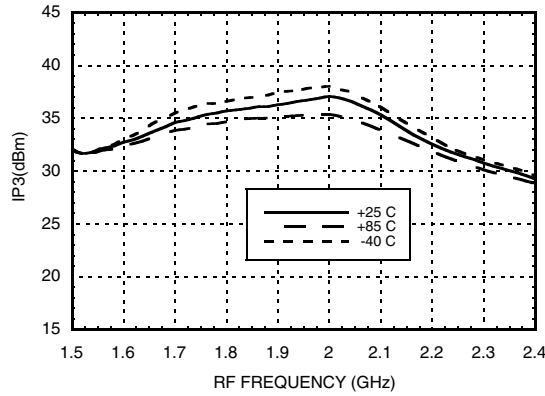

Input IP3 vs. LO Drive [2]

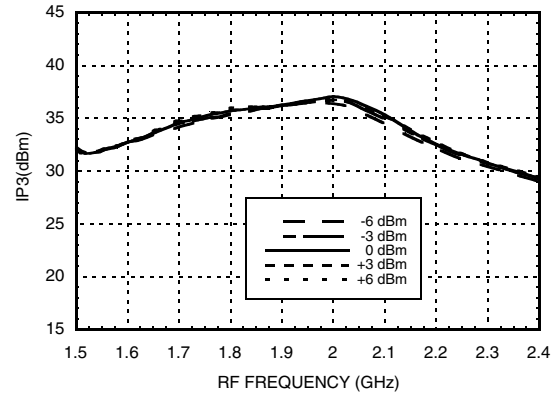

Input IP3 vs. Icc [2]

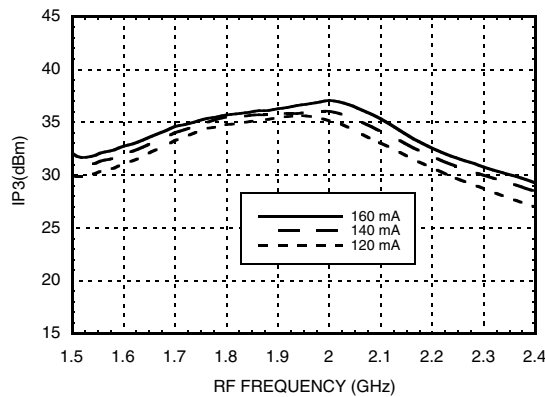

Input IP3 vs. G_Bias Voltage [2]

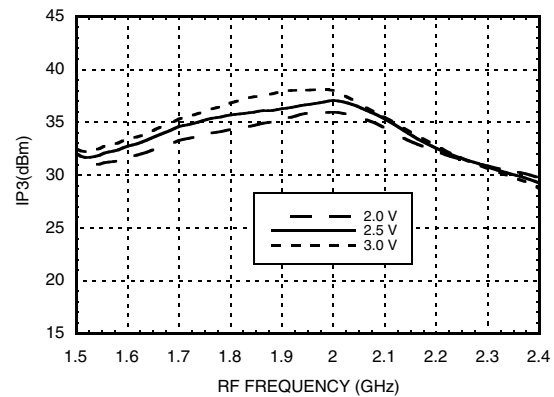

Input IP3 vs. IF Frequency [2]

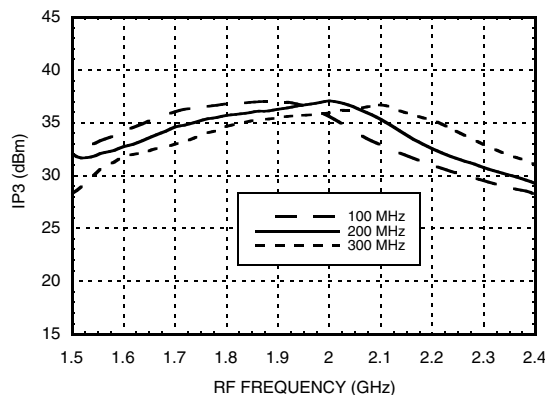

Input P1dB vs. Temperature

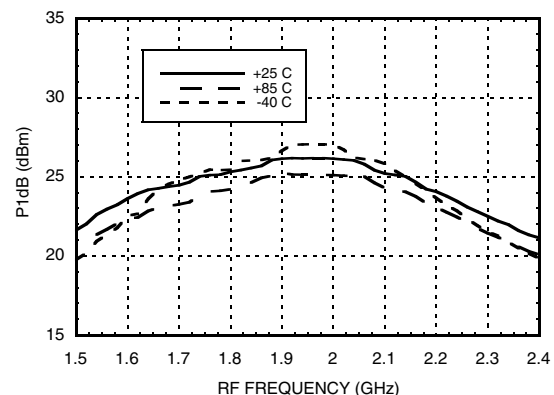

[1] See Upconverter Evaluation PCB and Schematic
 [2] Two-tone input power = +9 dBm each tone, 1 MHz spacing.

BiCMOS MIXER W/ INTEGRATED LO AMPLIFIER, 1.7 - 2.2 GHz



I_{cc} vs. R₉

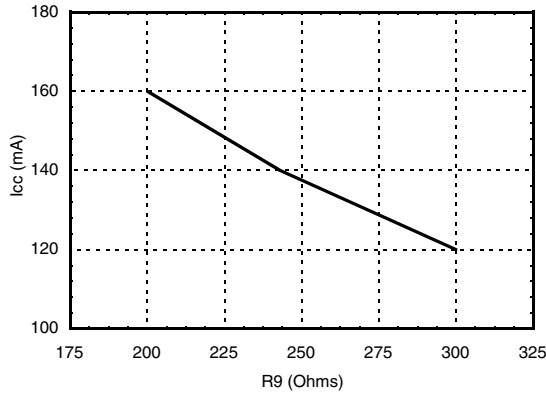

Typical Supply Current vs. V_{cc}

V _{cc} 1, 2, 3 (V)	I _{cc} total (mA)
4.75	147
5.00	160
5.25	173

Absolute Maximum Ratings

V _{cc} 1-3	5.5 Vdc
RF Input Power (V _{cc} 1, 2, 3 = +5V)	+23 dBm
IF Input Power (V _{cc} 1, 2, 3 = +5V)	+20 dBm
LO Drive (V _{cc} 1, 2, 3 = +5V)	+10 dBm
Junction Temperature	125 °C
Continuous P _{diss} (T=85 °C) (derate 27 mW/°C above 85 °C)	1.08 W
Thermal Resistance (junction to ground paddle)	37.04 °C/W
Storage Temperature	-65 to 150 °C
Operating Temperature	-40 to +85 °C
ESD Sensitivity (HBM)	Class 1A



**ELECTROSTATIC SENSITIVE DEVICE
OBSERVE HANDLING PRECAUTIONS**

Outline Drawing

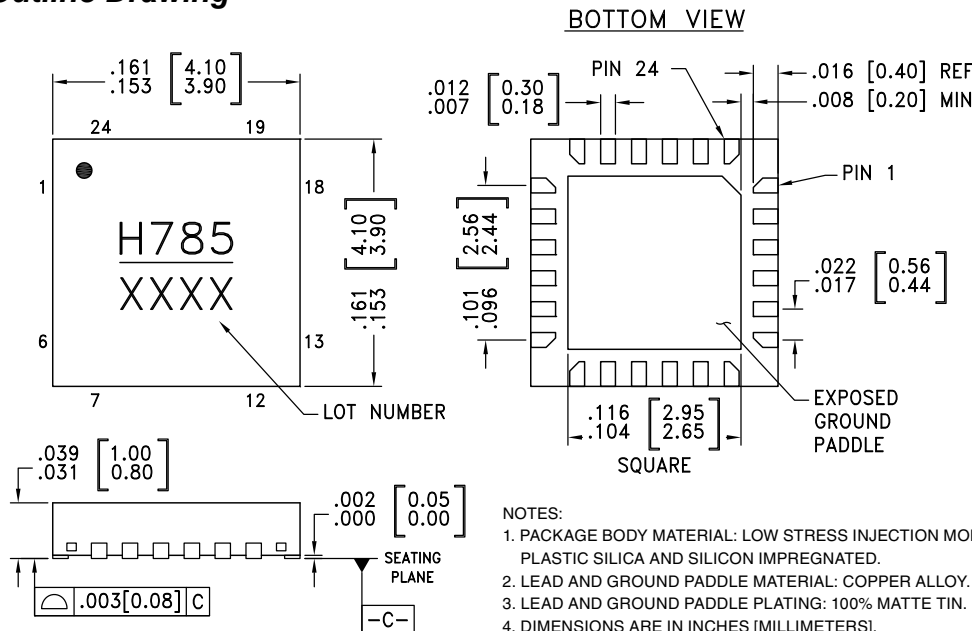

- NOTES:**
1. PACKAGE BODY MATERIAL: LOW STRESS INJECTION MOLDED PLASTIC SILICA AND SILICON IMPREGNATED.
 2. LEAD AND GROUND PADDLE MATERIAL: COPPER ALLOY.
 3. LEAD AND GROUND PADDLE PLATING: 100% MATTE TIN.
 4. DIMENSIONS ARE IN INCHES [MILLIMETERS].
 5. LEAD SPACING TOLERANCE IS NON-CUMULATIVE.
 6. PAD BURR LENGTH SHALL BE 0.15mm MAX. PAD BURR HEIGHT SHALL BE 0.25mm MAX.
 7. PACKAGE WARP SHALL NOT EXCEED 0.05mm
 8. ALL GROUND LEADS AND GROUND PADDLE MUST BE SOLDERED TO PCB RF GROUND.
 9. REFER TO HITTITE APPLICATION NOTE FOR SUGGESTED PCB LAND PATTERN.

Package Information

Part Number	Package Body Material	Lead Finish	MSL Rating	Package Marking ^[2]
HMC785LP4E	RoHS-compliant Low Stress Injection Molded Plastic	100% matte Sn	MSL1 ^[1]	H785 XXXX

[1] Max peak reflow temperature of 260 °C

[2] 4-Digit lot number XXXX

Information furnished by Analog Devices is believed to be accurate and reliable. However, no responsibility is assumed by Analog Devices for its use, nor for any infringements of patents or other rights of third parties that may result from its use. Specifications subject to change without notice. No license is granted by implication or otherwise under any patent or patent rights of Analog Devices. Trademarks and registered trademarks are the property of their respective owners.

For price, delivery, and to place orders: Analog Devices, Inc., One Technology Way, P.O. Box 9106, Norwood, MA 02062-9106 Phone: 781-329-4700 • Order online at www.analog.com Application Support: Phone: 1-800-ANALOG-D

**BiCMOS MIXER W/ INTEGRATED
LO AMPLIFIER, 1.7 - 2.2 GHz**

Pin Descriptions

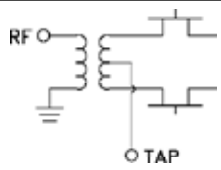
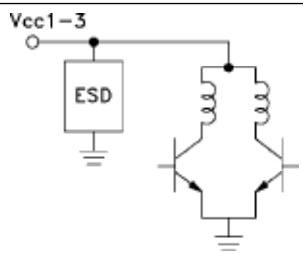
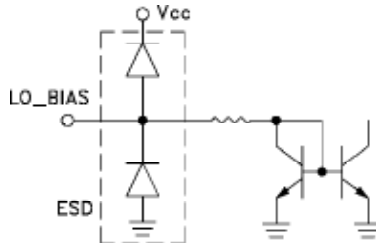
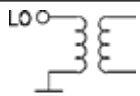
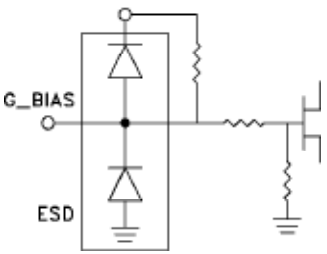
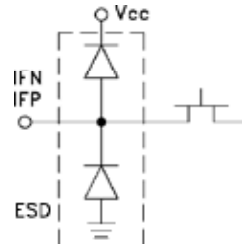
Pin Number	Function	Description	Interface Schematic
1, 6, 7, 11 - 14, 18, 20, 23	N/C	No connection. These pins may be connected to RF ground. Performance will not be affected.	
2, 5, 15, 17	GND	Package bottom must be connected to RF/DC ground.	
3	RF	This pin is matched single-ended to 50 Ohms and DC shorted to ground through a balun.	
4	TAP	Center tap of secondary side of the internal RF balun. Short to ground with zero Ohms close to the IC.	
8, 10, 24	Vcc1, Vcc2, Vcc3	Power supply voltage. See application circuit for required external components.	
9	LO_BIAS	LO buffer current adjustment pin. Adjust the LO buffer current through the external resistor R9 shown in the application circuit (connect 200 Ohms for nominal operation). This adjustment allows for a trade-off between power dissipation and linearity performance of the converter.	
16	LO	This pin is matched single-ended 50 Ohm and DC shorted to ground through a balun.	
19	G_BIAS	External bias with a nominal value of 2.5V. See application circuit for recommended external components. G_Bias can be set to between 0 and 5Vdc. This adjustment allows for a trade off between conversion loss and linearity performance of the converter (see figures CG, IP3 vs. G-Bias). The G_bias pin has an internal 15 KOhms resistance to ground and 15 KOhms to Vcc. Internal resistive divider sets 2.5 V for G_bias and can be changed externally.	
21, 22	IFN, IFP	Differential IF input / output pins matched to differential 50 Ohms. For applications not requiring operation to DC an off chip DC blocking capacitor should be used.	

BiCMOS MIXER W/ INTEGRATED LO AMPLIFIER, 1.7 - 2.2 GHz



Evaluation PCB - Downconverter

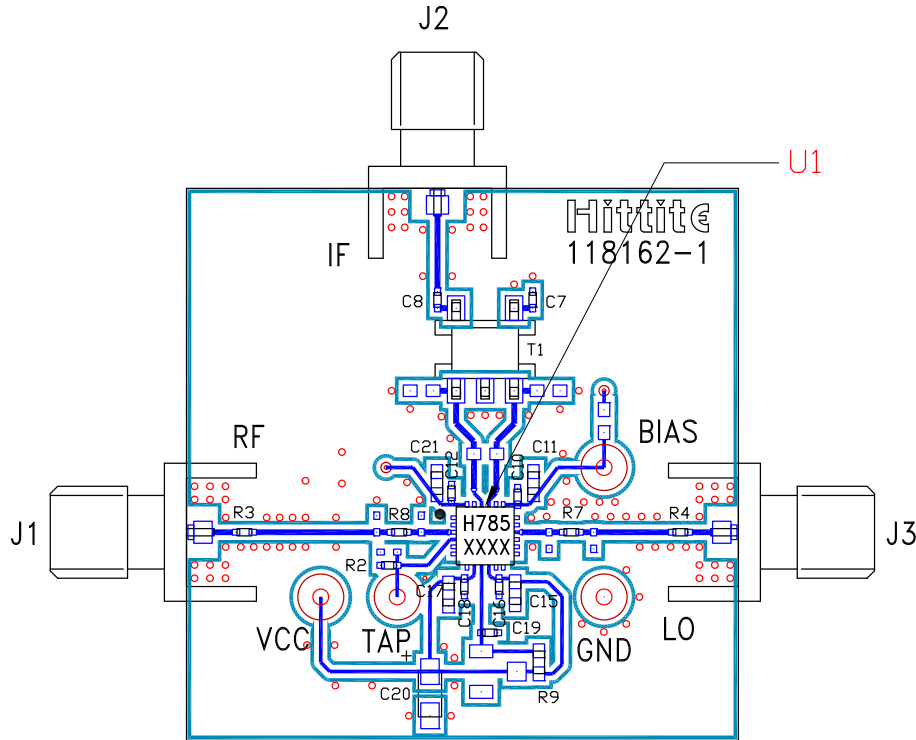

List of Materials for Evaluation PCB 125329 [1]

Item	Description
J1 - J3	SMA Connector
J4 - J7	DC Pin
C7, C8	10 nF Capacitor, 0402 Pkg.
C10, C12, C16, C18	1 nF Capacitor, 0402 Pkg.
C11, C15, C17, C21	0.1 μF Capacitor, 0402 Pkg.
C19	22 pF Capacitor, 0402 Pkg.
C20	4.7 μF Case A, Tantalum
R2 - R4, R7, R8	0 Ohm Resistor, 0402 Pkg.
R9	200 Ohm Resistor, 0603 Pkg.
T1	1:1 Transformer - Tyco MABA CT0039
U1	HMC785LP4E
PCB [2]	118162 Evaluation PCB

The circuit board used in the final application should use RF circuit design techniques. Signal lines should have 50 Ohm impedance while the package ground leads and exposed paddle should be connected directly to the ground plane similar to that shown. A sufficient number of via holes should be used to connect the top and bottom ground planes. The evaluation circuit board shown is available from Hittite upon request.

[1] Reference this number when ordering complete evaluation PCB

[2] Circuit Board Material: Rogers 4350 or Arlon 25FR

BiCMOS MIXER W/ INTEGRATED LO AMPLIFIER, 1.7 - 2.2 GHz



Application Circuit - Downconverter

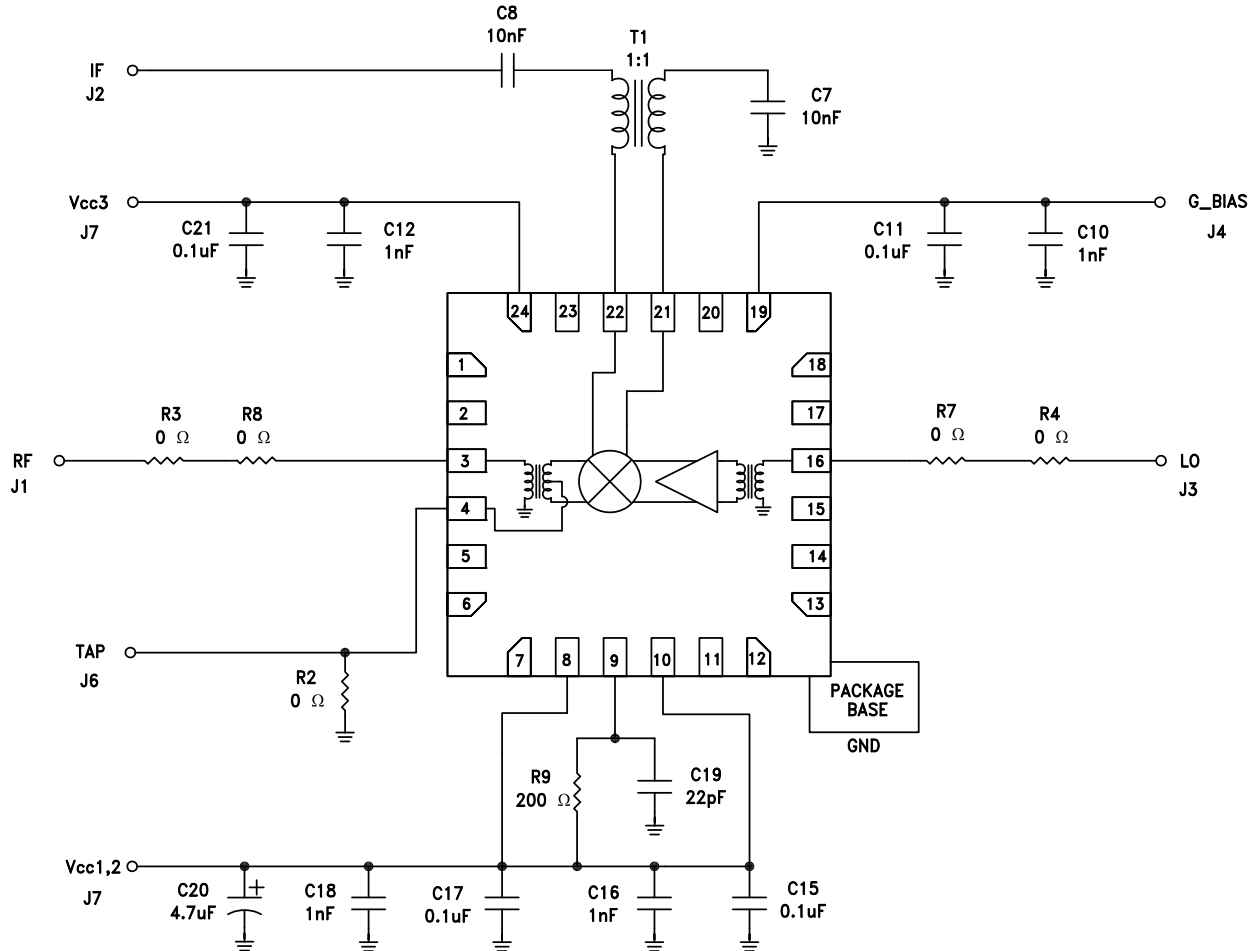

10

MIXERS - SINGLE & DOUBLE BALANCED - SMT

Information furnished by Analog Devices is believed to be accurate and reliable. However, no responsibility is assumed by Analog Devices for its use, nor for any infringements of patents or other rights of third parties that may result from its use. Specifications subject to change without notice. No license is granted by implication or otherwise under any patent or patent rights of Analog Devices. Trademarks and registered trademarks are the property of their respective owners.

For price, delivery, and to place orders: Analog Devices, Inc., One Technology Way, P.O. Box 9106, Norwood, MA 02062-9106 Phone: 781-329-4700 • Order online at www.analog.com Application Support: Phone: 1-800-ANALOG-D

**BiCMOS MIXER W/ INTEGRATED
LO AMPLIFIER, 1.7 - 2.2 GHz**



Evaluation PCB - Upconverter

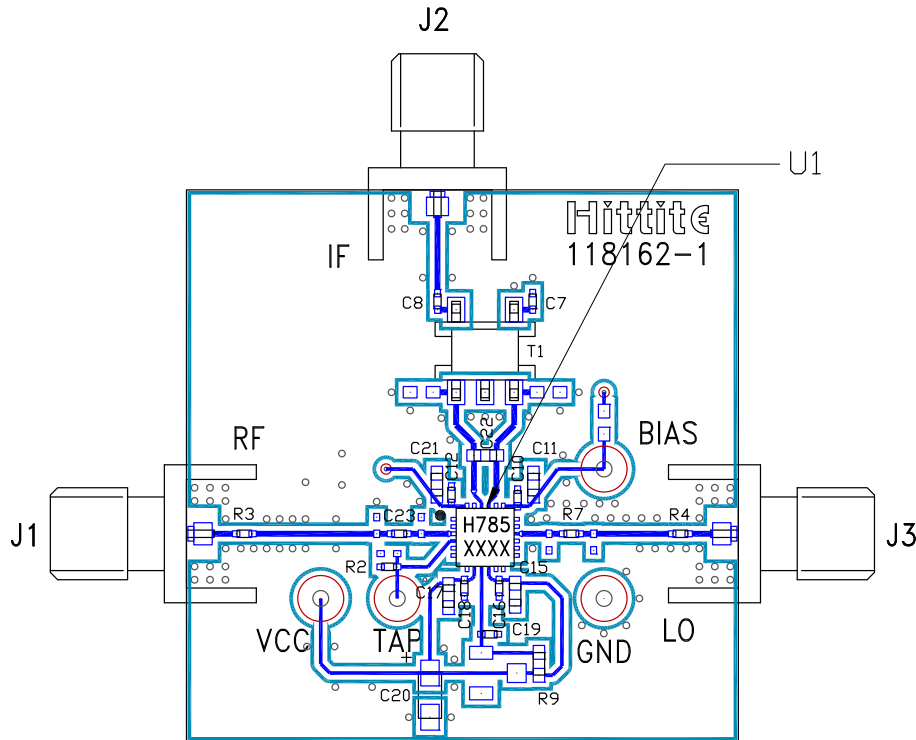

List of Materials for Evaluation PCB 125354 [1]

Item	Description
J1 - J3	SMA Connector
J4 - J7	DC Pin
C7, C8	10 nF Capacitor, 0402 Pkg.
C10, C12, C16, C18	1 nF Capacitor, 0402 Pkg.
C11, C15, C17, C21	0.1 μF Capacitor, 0402 Pkg.
C19	22 pF Capacitor, 0402 Pkg.
C20	4.7 μF Case A, Tantalum
C22	1 pF Capacitor, 0603 Pkg.
C23	1.8 pF Capacitor, 0402 Pkg.
R2 - R4, R7	0 Ohm Resistor, 0402 Pkg.
R9	200 Ohm Resistor, 0603 Pkg.
T1	1:1 Transformer - Tyco MABA CT0039
U1	HMC785LP4E
PCB [2]	118162 Evaluation PCB

The circuit board used in the final application should use RF circuit design techniques. Signal lines should have 50 Ohm impedance while the package ground leads and exposed paddle should be connected directly to the ground plane similar to that shown. A sufficient number of via holes should be used to connect the top and bottom ground planes. The evaluation circuit board shown is available from Hittite upon request.

[1] Reference this number when ordering complete evaluation PCB

[2] Circuit Board Material: Rogers 4350 or Arlon 25FR

BiCMOS MIXER W/ INTEGRATED LO AMPLIFIER, 1.7 - 2.2 GHz



Application Circuit - Upconverter

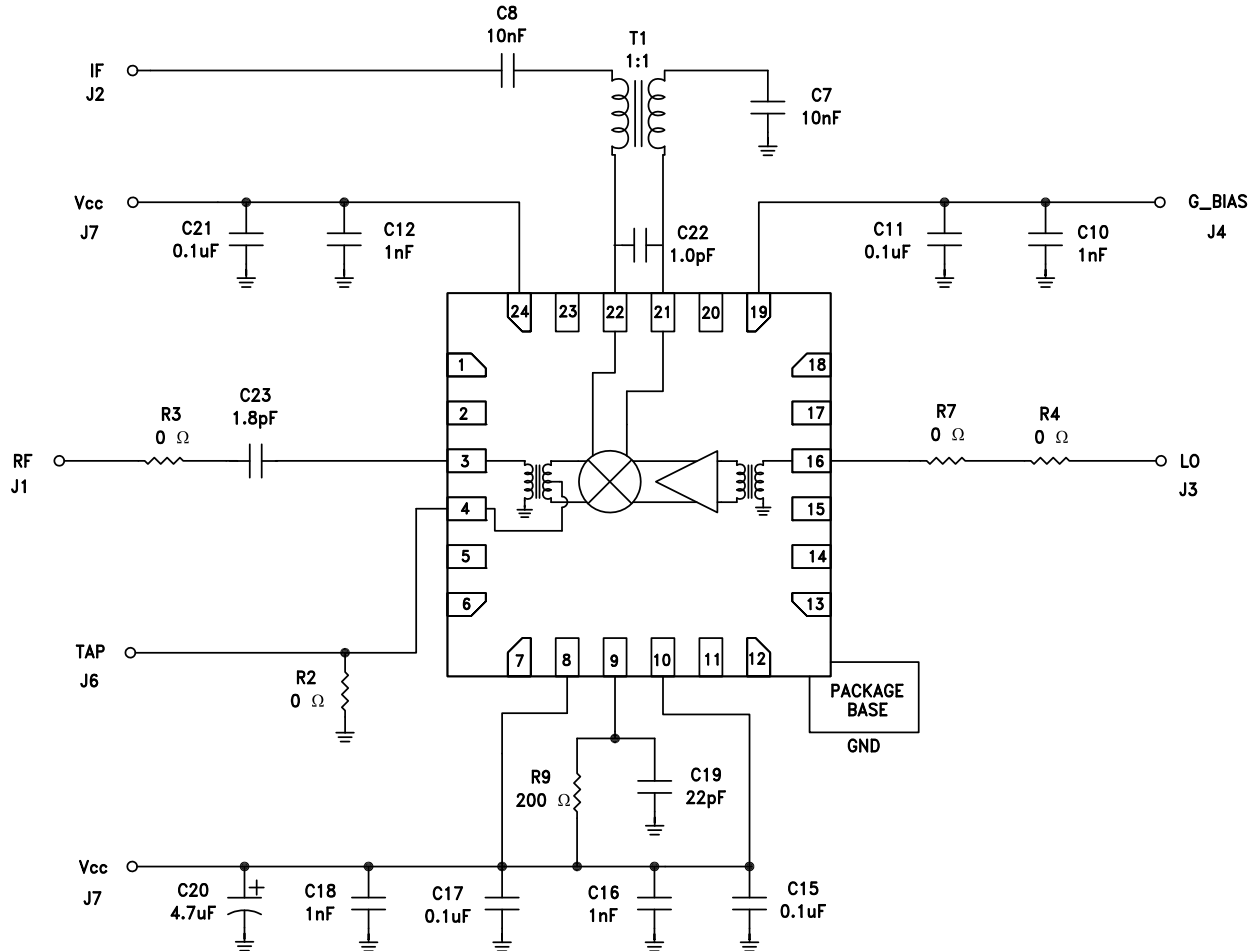

10

MIXERS - SINGLE & DOUBLE BALANCED - SMT

Information furnished by Analog Devices is believed to be accurate and reliable. However, no responsibility is assumed by Analog Devices for its use, nor for any infringements of patents or other rights of third parties that may result from its use. Specifications subject to change without notice. No license is granted by implication or otherwise under any patent or patent rights of Analog Devices. Trademarks and registered trademarks are the property of their respective owners.

For price, delivery, and to place orders: Analog Devices, Inc., One Technology Way, P.O. Box 9106, Norwood, MA 02062-9106 Phone: 781-329-4700 • Order online at www.analog.com Application Support: Phone: 1-800-ANALOG-D