



# Atmel LED Driver-MSLB9061 LED Driver Module

Compact, 6-channel LED Driver Board with I<sup>2</sup>C Interface

Datasheet



# Atmel LED Driver-MSLB906 1

## LED Driver Module

Compact, 6-channel LED Driver Board with I<sup>2</sup>C Interface

### General Description

The Atmel<sup>®</sup> compact, 6-channel LED driver board is a complete LED backlight driver solution using the Atmel LED Driver-MSL1061 LED driver for medium-sized LCD panels. Each channel drives up to 12 series-connected LEDs at up to 30mA per channel. The driver board is configured to operate from 3.3V up to 28V. The full-scale LED current is preset to 15, 20, 25, or 30mA per LED string, selected by an onboard switch. Current can be reduced from full-scale through the I<sup>2</sup>C serial interface in 16 linear steps. Digital (PWM) dimming is available through an external signal or by using the internal PWM generator via the serial interface.

The optional microcontroller board and graphical user interface (GUI) software allow control of the driver board through a personal computer. This gives access to the internal features of the MSL1061, including fault detection, digital control of LED current, individual LED string on/off control, and internally generated PWM dimming.

The compact six-channel LED driver board is intended for evaluation, prototyping, or production runs. Gerber files and Cadence OrCAD layout files are available to allow the circuit to be integrated into a larger system for large production runs.

### Applications

- LCD Panel LED Backlight Driver

### Ordering Information

| PART     | DESCRIPTION                          |
|----------|--------------------------------------|
| MSLB9061 | Compact, 6-channel LED driver module |

# Atmel LED Driver-MSLB906 1 LED Driver Module

Compact, 6-channel LED Driver Board with I<sup>2</sup>C Interface

## Key Features

- Drives up to 6 LED Strings
- Up to 12 LEDs per String
- Up to 30mA per LED String
- I<sup>2</sup>C Serial Interface
- Fault Detection and Protection
- 3.3 to 28V Input Voltage Range
- Up to 7.2W Output Power
- Small Size, 1.95" X 0.73"
- Four Available I<sup>2</sup>C Slave Addresses, Switch Selectable
- Four Full-scale Current Settings, Switch Selectable
- Separate Bias and Power Inputs Allows a Variety Of Configurations
- 1Mhz Switching Frequency
- Internal Or External PWM Dimming Control
- Digital Control of LED String Current
- Individual LED String On/Off Digital Control
- Short Circuit or Open Circuit LED String Detection
- Automatic Overvoltage Protection

## LED Driver Board





## Mechanical Drawing



Figure 1. Atmel® LED Driver-MSLB9061 Mechanical Drawing. All Dimensions in Inches.

## Connector Pin Descriptions

Table 1. J2 Input Connector Pin Descriptions

| PIN NAME | PIN NUMBER | PIN DESCRIPTION                                   |
|----------|------------|---|
| PWR      | 1,2        | Input power to integrated boost regulator circuit |
| HVBIAS   | 3          | Input to integrated LDO bias voltage regulator    |
| LVBIAS   | 4          | Input to MSL1061 bias voltage                     |
| DOUBLE   | 5          | Input to charge pump doubler bias input           |
| SDA      | 6          | I <sup>2</sup> C serial data                      |
| SCL      | 7          | I <sup>2</sup> C serial clock                     |
| FLT B    | 8          | Fault indication output                           |
| EN       | 9          | Enable control input                              |
| PWM      | 10         | PWM dimming control input                         |
| GND      | 11,12      | Ground  |

Table 2. J3 Output Connector Pin Descriptions

| PIN NAME | PIN NUMBER | PIN DESCRIPTION                 |
|----------|------------|---------------------------------|
| GND      | 1-8        | Ground                          |
| STR6     | 9          | LED string 6 cathode connection |
| STR5     | 10         | LED string 5 cathode connection |
| STR4     | 11         | LED string 4 cathode connection |
| STR3     | 12         | LED string 3 cathode connection |
| STR2     | 13         | LED string 2 cathode connection |
| STR1     | 14         | LED string 1 cathode connection |
| VLED     | 15-20      | LED sting anode output voltage  |

# Atmel LED Driver-MSLB906 1

## LED Driver Module

Compact, 6-channel LED Driver Board with I<sup>2</sup>C Interface

### Absolute Maximum Ratings

#### Voltage (With Respect to GND)

|  |                |
|--|----------------|
| STR1-STR6.....   | -0.3V to +50V  |
| VLED.....  | -0.3V to +40V  |
| PWR, HVBIAS.....   | -0.3V to +36V  |
| BIAS, EN, PWM, SDA, SCL, FLTB.....                                     | -0.3V to +5.5V |
| Ambient operating temperature range $T_A = T_{MIN}$ to $T_{MAX}$ ..... | -40°C to +50°C |

**Table 3 : Electrical Operating Characteristics**

(Typical application circuit,  $V_{IN} = 12V$ ,  $T_A = T_{MIN}$  to  $T_{MAX}$  unless otherwise noted. Typical values are at  $T_A = +25^\circ C$ )

| PARAMETER                            | CONDITIONS AND NOTES  | MIN  | TYP | MAX | UNIT |
|--------------------------------------|---|------|-----|-----|------|
| <b>DC ELECTRICAL CHARACTERISTICS</b> |   |      |     |     |      |
| Power input voltage                  | (Note 1)  | 3.3V |     | 28  | V    |
| HVBIAS input voltage                 | Bias voltage applied to HVBIAS, BIAS unconnected                          | 6.5  |     | 28  | V    |
| BIAS input voltage                   | HVBIAS and BIAS inputs connected with bias voltage applied                | 4.5  |     | 6   | V    |
| DOUBLE input voltage                 | HVBIAS and BIAS inputs connected together, bias voltage applied to DOUBLE | 3.1  |     | 3.6 | V    |
| EN logic input high level            |   | 2.3  |     |     | V    |
| EN logic input low level             |   |      |     | 0.8 | V    |
| PWM, SDA, SCL input high voltage     |   | 2    |     |     | V    |
| PWM, SDA, SCL Input low voltage      |   |      |     | 0.9 | V    |
| FLTB output low voltage              | $I_{FLTB} = 1mA$  |      |     | 0.1 | V    |
| FLTB leakage current                 | $V_{FLTB} = 3.6V$   |      |     | 1   | A    |
| STR1-STR6 output current             | ISTRn = 0x0F, S2 position 1   |      | 30  |     | mA   |
|                                      | ISTRn = 0x0F, S2 position 2   |      | 25  |     | mA   |
|                                      | ISTRn = 0x0F, S2 position 3   |      | 15  |     | mA   |
|                                      | ISTRn = 0x0F, S2 position 4   |      | 10  |     | mA   |

| PARAMETER                            | CONDITIONS AND NOTES | MIN | TYP | MAX | UNIT |
|--------------------------------------|----------------------|-----|-----|-----|------|
| <b>AC ELECTRICAL CHARACTERISTICS</b> |                      |     |     |     |      |
| PWM input frequency                  |                      |     |     | 20  | kHz  |



| PARAMETER   | CONDITIONS AND NOTES                       | MIN  | TYP | MAX  | UNIT |
|---|--|------|-----|------|------|
| <b>I<sup>2</sup>C SWITCHING CHARACTERISTICS</b>                   |  |      |     |      |      |
| SCL clock frequency   | I <sup>2</sup> C timeout disabled (Note 2) |      |     | 1000 | kHz  |
| Bus timeout   |  |      | 25  |      | ms   |
| Bus free time between a STOP and START condition                  |  | 0.5  |     |      | μs   |
| Hold time for a repeated START condition                          |  | 0.26 |     |      | μs   |
| Set-up time for a repeated START condition                        |  | 0.26 |     |      | μs   |
| Set-up time for STOP condition                                    |  | 0.26 |     |      | μs   |
| Data hold time  |  | 10   |     |      | ns   |
| Data valid acknowledge time                                       | (Note 3)                                   | 0.05 |     | 0.45 | μs   |
| Data valid time   | (Note 4)                                   | 0.05 |     | 0.45 | μs   |
| Data set-up time  |  | 100  |     |      | ns   |
| LOW period of the SCL clock                                       |  | 0.5  |     |      | μs   |
| HIGH period of the SCL clock                                      |  | 0.26 |     |      | μs   |
| Fall time of SDA and SCL signals                                  | (Note 5,6)                                 |      |     | 120  | ns   |
| Rise time of both SDA and SCL signals                             |  |      |     | 120  | ns   |
| Pulse width of spikes that must be suppressed by the input filter | (Note 7)                                   |      | 50  |      | ns   |
| SDA, SCL, AD0 input capacitance                                   |  |      | 10  |      | pF   |

- Note 1. Full power available with PWR input voltage greater than 6.5V. For 3.1V to 3.6V operation, doubling charge pump(U2) and C12, C13 are required.
- Note 2. Minimum SCL clock frequency is limited by the bus timeout feature, which resets the serial bus interface if either SDA or SCL is held low for 25ms. Disable bus timeout feature for DC operation.
- Note 3. Time for acknowledge signal from SCL low to SDA (out) low.
- Note 4. Minimum time for SDA data out to be valid following SCL low.
- Note 5. A master device must internally provide a hold time of at least 300ns for the SDA signal (refer to the  $V_{IL}$  of the SCL signal) in order to bridge the undefined region of SCL falling edge.
- Note 6. The maximum fall times for the SDA and SCL bus lines are specified at 300ns. The maximum fall time for the SDA output stage is specified at 250ns. This allows series protection resistors to be connected between SDA and SCL and the SDA/SCL bus lines without exceeding the maximum specified fall time.
- Note 7. Input filters on the SDA, SCL, and AD0 inputs suppress noise less than 50ns.

# Atmel LED Driver-MSLB9061 LED Driver Module

Compact, 6-channel LED Driver Board with I<sup>2</sup>C Interface

## Typical Performance Characteristics



## Detailed Description

The MSLB9061 is a standalone, six-channel LED driver board suitable for integration into small production devices. It includes an I<sup>2</sup>C serial interface for accessing the digital features of the MSL1061 LED driver. Onboard switches set the I<sup>2</sup>C slave address to one of four available addresses and the full-scale LED current to 30, 25, 15, or 10mA.

### Input Power

The MSLB9061 board is powered from input voltages ranging from 3.3 up to 28V, and the integral boost regulator power is separate, allowing operation with separate bias and power input voltages for improved efficiency or operation from a single input power source for simplicity. Full power is available for power (PWR) input voltage greater than 6.5V.



## Single Input Voltage Configuration

The MSLB9061 board can be powered from a single input voltage source. The configuration depends on the input voltage range. The three available configurations are:

- Input voltage between 5.5V and 28V. Apply the input voltage to the PWR and HVBIAS inputs, J2 pins 1, 2, and 3, simultaneously. Leave BIAS and DOUBLE, J2 pins 4 and 5, unconnected. Full power is available in this configuration with an input voltage greater than 6.5V.
- Input voltage between 4.5V and 6V. Apply the input voltage to the PWR, HVBIAS, and BIAS inputs, J2 pins 1, 2, 3, and 4, simultaneously. Leave DOUBLE, J2 pin 5, unconnected. Full power is not available in this configuration.
- Input voltage between 3.1V and 3.6V. Apply the input voltage to the PWR and DOUBLE inputs, J2 pins 1, 2, and 5. Connect the BIAS and HVBIAS inputs, J2 pins 3 and 4, together, but do not apply voltage. Full power is not available in this configuration.

## Separate Power and Bias Input Configuration

The MSLB9061 board can be powered from separate power and bias input voltage sources. With input

bias voltage below the input power voltage, power dissipation is reduced for improved power efficiency. In all cases, apply the power input voltage to the PWR inputs, J2 pins 1 and 2. Full output power is available for an input voltage greater than 6.5V. The three available bias configurations are:

- 5.5V to 28V bias input voltage. Connect the bias voltage to the HVBIAS input, J2 pin 3. Leave BIAS and DOUBLE inputs, J2 pins 4 and 5, unconnected.
- 4.5V to 6V bias input voltage. Connect the bias voltage to the HVBIAS and BIAS inputs, J2 pins 3 and 4, simultaneously. Leave DOUBLE, J2 pin 5, unconnected.
- 3.1V to 3.6V bias input voltage. Connect the bias voltage to DOUBLE, J2 pin 5. Connect the HVBIAS and BIAS inputs, J2 pins 3 and 4, together, but do not apply voltage.

## I<sup>2</sup>C Serial Interface

The MSLB9061 driver board uses an I<sup>2</sup>C/SMBus serial interface for digital LED control and fault detection. Four slave ID addresses are available, and are selected by the I<sup>2</sup>C address selection switch. The addresses are shown in Table 4.



# Atmel LED Driver-MSLB906 1

## LED Driver Module

Compact, 6-channel LED Driver Board with I<sup>2</sup>C Interface

**Table 4: I<sup>2</sup>C Slave Address Switch (S1) Settings**

| ADDRESS SWITCH S1 POSITION  | I <sup>2</sup> C SLAVE ADDRESS | ADDRESS SWITCH S1 POSITION   | I <sup>2</sup> C SLAVE ADDRESS |
|---|--------------------------------|--|--------------------------------|
|  <p>Position 1</p> | 1100_000 (binary)              |  <p>Position 3</p> | 1100_010 (binary)              |
|  <p>Position 2</p> | 1100_011 (binary)              |  <p>Position 4</p> | 1100_001 (binary)              |

There are a number of features available through the I<sup>2</sup>C serial interface. Table 5 shows the registers for the MSL1061 LED driver.



**Table 5. Atmel LED Driver-MSL1061 Register Map**

| REGISTER NAME | ADDRESS | BIT |       |        |        |        |        |        |        | DESCRIPTION |  |
|---------------|---------|-----|-------|--------|--------|--------|--------|--------|--------|-------------|--|
|               |         | D7  | D6    | D5     | D4     | D3     | D2     | D1     | D0     |             |  |
| MSTRCNTRL     | 0x00    | -   | -     | -      | -      | -      | -      | -      | -      | SLEEP       | Sleep enable   |
| CNTRL         | 0x01    | -   | -     | -      | -      | INTPWM | EXTCLK | TOEN   | FLTEN  |             | Internal/external generated PWM, internal/external clock, I <sup>2</sup> C timeout and fault pin enable. |
| STATUS        | 0x03    | -   | OTDET | SCDET  | OCDET  | -      | -      | -      | FLTDET |             | Open/short detect, over-temperature detect.  |
| OCSTATUS      | 0x04    | -   | -     | OC6    | OC5    | OC4    | OC3    | OC2    | OC1    |             | LED open circuit detected on STR6 – STR1   |
| SCSTATUS      | 0x05    | -   | -     | SC6    | SC5    | SC4    | SC3    | SC1    | SC0    |             | LED short circuit to VOUT detected on STR6 – STR1  |
| PWMFREQ       | 0x06    | D7  | D6    | D5     | D4     | D3     | D2     | D1     | D0     |             | Internal PWM frequency (prescaler) generator   |
| PWMDUTY       | 0x07    | D7  | D6    | D5     | D4     | D3     | D2     | D1     | D0     |             | Internal PWM duty cycle generator  |
| STREN         | 0x09    | -   | -     | STR6EN | STR5EN | STR4EN | STR3EN | STR2EN | STR1EN |             | String enable, shutdown control  |
| IDAC          | 0x10    | -   | -     | -      | -      | DAC3   | DAC2   | DAC1   | DAC0   |             | 4-bit current DAC  |

For detailed descriptions of the Atmel LED Driver-MSL1061 register-controlled operating modes, see the Atmel LED Driver-MSL1061 Datasheet.

# Atmel LED Driver-MSLB9061

## LED Driver Module

Compact, 6-channel LED Driver Board with I<sup>2</sup>C Interface

### On/Off (EN) Control Input

The on/off control input, pin 9 of input connector J2, turns on/off the LED driver. Drive it high (between 2.3 and 5V) to turn on the LED driver, and drive it low (0 to 0.8V) to turn it off. The on/off control input is internally pulled up by a 100k $\Omega$  resistor. For automatic start-up, leave it unconnected.

### PWM Control Input

The input connector, J2, pin 10, is the PWM control input. Drive PWM with a digital signal to pulse-width modulate (PWM) the LED brightness. When using the internal PWM generator, the PWM input signal is ignored. The PWM input is pulled high through a 100k $\Omega$  resistor. If not used, leave PWM unconnected or drive it high.

### Fault Indicator Output

The MSL1061 includes fault detection circuitry that detects an open-circuited LED string or an LED string with one or more short-circuited LEDs. If any fault is detected, the fault indicator output is driven low. Use this output as an alert signal to a system controller. Once the controller gets the alert signal, it determines which LED is faulty by reading the STATUS, OCSTATUS, and SCSTATUS registers through the I<sup>2</sup>C serial interface.

### Connecting the LEDs to the Atmel LED Driver-MSLB9061 LED Driver

The MSLB9061 driver board drives LED arrays with up to six parallel strings of up to 12 series LEDs each through the output connector, J3. Six connections for LED cathode connections allow the use of separate LED strings, or common-anode-connected LED strings. Connect unused LED cathode string connections (J3 pins 9-14) to GND to disable that LED string. J3 pins 1-8 are provided for this purpose so that unused string cathode connections are connected to GND through the wiring harness.

### Setting the Full-Scale LED Current

The MSL1061 regulates the LED string current. The LED string current is set by a current sense resistor. Four different values are programmed to the MSLB9061 LED driver module, and the switch S2 selects one of those resistors to set the full-scale per-string LED current to 10mA, 15mA, 25mA or 30mA. Table 6 shows the switch settings and the full-scale per-string LED current for each setting.

**Table 6: Full-Scale Per-String LED Current (S2) Settings**

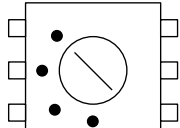
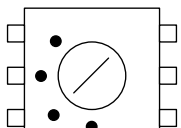
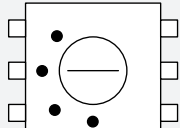
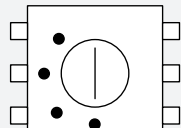
| Full-Scale LED Current Switch S2 Position   | Full-Scale Per-String LED Current | Full-Scale LED Current Switch S2 Position  | Full-Scale Per-String LED Current |
|---|-----------------------------------|--|-----------------------------------|
| <br>Position 1 | 30mA                              | <br>Position 3 | 15mA                              |
| <br>Position 2 | 25mA                              | <br>Position 4 | 10mA                              |

### Driving LEDs with Greater than 30mA LED Current

The maximum current available from each LED driver is 30mA. When using LEDs that require greater than 30mA, connect multiple LED drivers in parallel to drive a single LED string. The LED string current is the sum of the LED driver currents. Table 7 shows a list of the higher currents that can be supported by this board.

**Table 7. Settings for Higher Currents**

| Current | # of Strings | EVU-MSL1061          |
|---------|--------------|----------------------|
| 40mA    | 2            | 2 x 20mA x 2 strings |
|         | 3            | 2 x 20mA x 3 strings |
| 50mA    | 2            | 2 x 25mA x 2 strings |
|         | 3            | 2 x 25mA x 3 strings |
| 60mA    | 2            | 2 x 30mA x 2 strings |
|         | 3            | 2 x 30mA x 3 strings |

# Atmel LED Driver-MSLB906 1 LED Driver Module

Compact, 6-channel LED Driver Board with I<sup>2</sup>C Interface

## Atmel LED Driver-MSLB906 1 Schematic

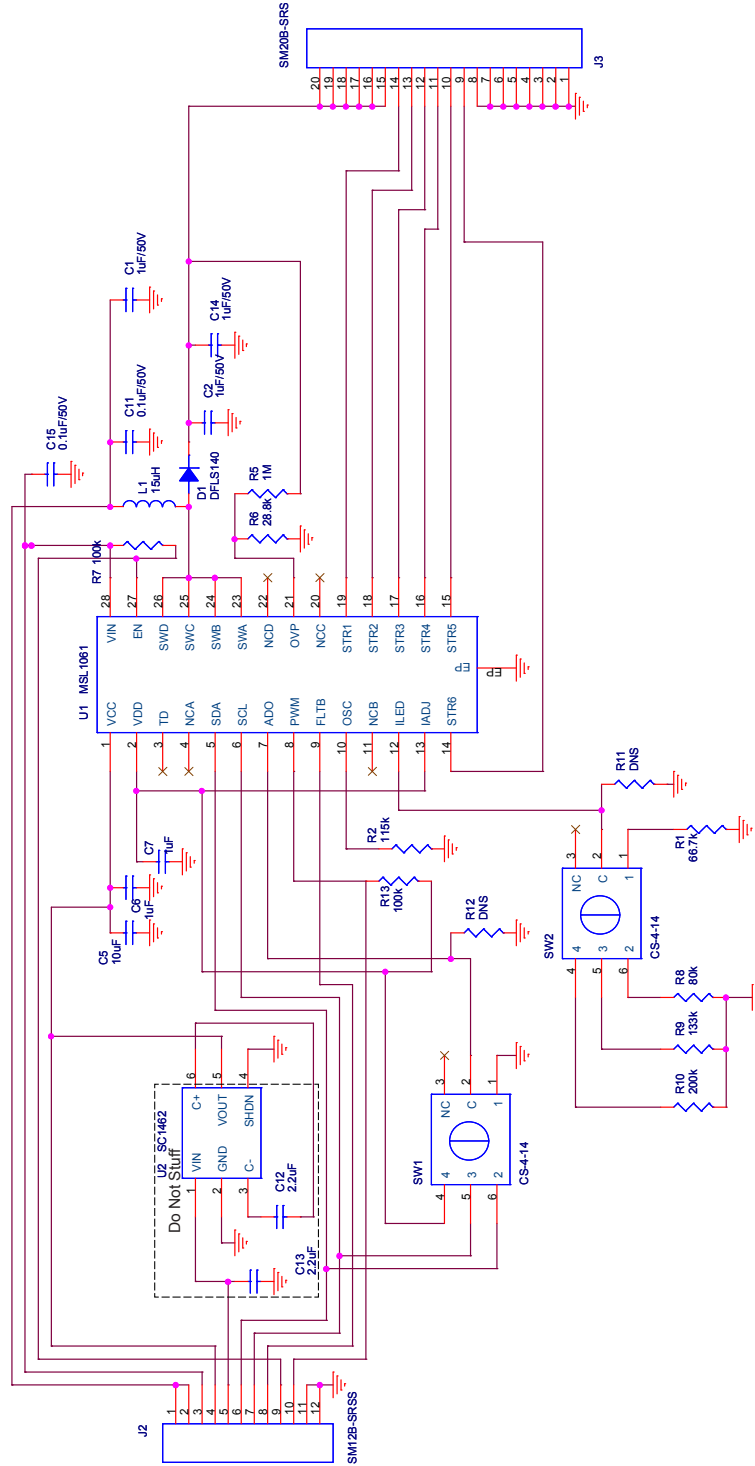
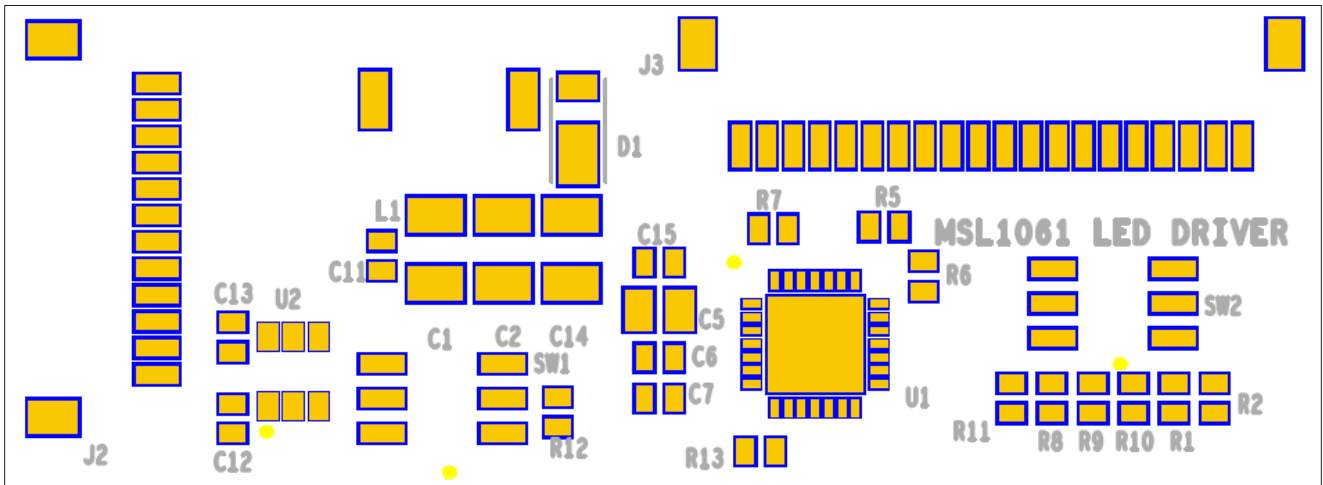

Figure 2: Atmel LED Driver-MSLB906 1 Board Schematic.

## Atmel LED Driver-MSLB9061 Component Placement



# Atmel LED Driver-MSLB9061

## LED Driver Module

Compact, 6-channel LED Driver Board with I<sup>2</sup>C Interface

### Atmel LED Driver-MSLB9061 Bill of Materials

| REF         | QTY | DESCRIPTION   | MANUFACTURER      | MANUFACTURER P/N                 |
|-------------|-----|---|-------------------|----------------------------------|
| C1, C2, C14 | 3   | Capacitor, ceramic, 1μF, 50V, X7R, 1206             | Murata            | GRM31CR71H105KA61L or equivalent |
| C5, C13*    | 2   | Capacitor, ceramic, 10μF, 6.3V, X7R, 0805           | Murata            | GRM21BR70J206KE76L or equivalent |
| C6, C7      | 2   | Capacitor, ceramic, 1μF, 10V, X7R, 0603             | Murata            | GRM188R7A105KA61D or equivalent  |
| C11, C15    | 2   | Capacitor, ceramic, 0.1μF, 50V, X7R, 0603           | Murata            | GRM188R71H104KA93D or equivalent |
| C12*        | 1   | Capacitor, ceramic, 2.2μF, 10V, X7R, 0603           | Murata            | GRM188R71A225KE15D or equivalent |
| D1          | 1   | Rectifier, Schottky, 1A, 40V, Power-Di 123          | Diodes Inc.       | DFLS140L-7 or equivalent         |
| J3          | 1   | Connector, 12-position, 1.0mm spacing, low profile  | JST               | SM12B-SRSS-TB                    |
| J3          | 1   | Connector, 20-position, 1.0mm spacing, low profile  | JST               | SM20B-SRSS-TB                    |
| L1          | 1   | Inductor, 15μH, 1.4A, CDRH5D28R/HP                  | Sumida            | CDRH5D28R/HP-150 or equivalent   |
| R1          | 1   | Resistor, 66.5KΩ, 1%, 0603                          | Rohm              | MCR03EZPFX6652 or equivalent     |
| R2          | 1   | Resistor, 115KΩ, 1%, 0603                           | Rohm              | MCR03EZPFX1153 or equivalent     |
| R5          | 1   | Resistor, 1.00MΩ, 1%, 0603                          | Rohm              | MCR03EZPFX1004 or equivalent     |
| R6          | 1   | Resistor, 28.7KΩ, 1%, 0603                          | Rohm              | MCR03EZPFX2872 or equivalent     |
| R7, R13     | 2   | Resistor, 100KΩ, 1%, 0603                           | Rohm              | MCR03EZPFX1003 or equivalent     |
| R8          | 1   | Resistor, 80.6KΩ, 1%, 0603                          | Rohm              | MCR03EZPFX8062 or equivalent     |
| R9          | 1   | Resistor, 133KΩ, 1%, 0603                           | Rohm              | MCR03EZPFX1333 or equivalent     |
| R10         | 1   | Resistor, 200KΩ, 1%, 0603                           | Rohm              | MCR03EZPFX2003 or equivalent     |
| SW1, SW2    | 2   | Switch, 4-position, rotary, surface mount, 4.5x5mm  | Copal Electronics | CS-4-14NTA or equivalent         |
| U1          | 1   | <b>LED driver with boost, six-channel, QFN55-28</b> | <b>MSL1061</b>    |                                  |
| U2*         | 1   | Doubling charge pump, SOT-23-6                      | Semtech           | SC1462ISKTR or equivalent        |

\* Foot print are available for optional use. Do not stuff.

**Atmel Corporation**

2325 Orchard Parkway  
San Jose, CA 95131  
USA

**Tel:** (+1)(408) 441-0311

**Fax:** (+1)(408) 487-2600

[www.atmel.com](http://www.atmel.com)

**Atmel Asia Limited**

Unit 01-5 & 16, 19F  
BEA Tower, Millennium City 5  
418 Kwun Tong Road  
Kwun Tong, Kowloon  
HONG KONG

**Tel:** (+852) 2245-6100

**Fax:** (+852) 2722-1369

**Atmel Munich GmbH**

Business Campus  
Parking 4  
D-85748 Garching b. Munich  
GERMANY

**Tel:** (+49) 89-31970-0

**Fax:** (+49) 89-3194621

**Atmel Japan**

9F, Tonetsu Shinkawa Bldg.  
1-24-8 Shinkawa  
Chuo-ku, Tokyo 104-0033  
JAPAN

**Tel:** (+81)(3) 3523-3551

**Fax:** (+81)(3) 3523-7581

© 2011 Atmel Corporation. All rights reserved. / Rev.: MEM-MSLB9061DS1-E-US\_06-11

Atmel®, logo and combinations thereof, and others are registered trademarks or trademarks of Atmel Corporation or its subsidiaries. Other terms and product names may be trademarks of others.

Disclaimer: The information in this document is provided in connection with Atmel products. No license, express or implied, by estoppel or otherwise, to any intellectual property right is granted by this document or in connection with the sale of Atmel products. EXCEPT AS SET FORTH IN THE ATMEL TERMS AND CONDITIONS OF SALES LOCATED ON THE ATMEL WEBSITE, ATMEL ASSUMES NO LIABILITY WHATSOEVER AND DISCLAIMS ANY EXPRESS, IMPLIED OR STATUTORY WARRANTY RELATING TO ITS PRODUCTS INCLUDING, BUT NOT LIMITED TO, THE IMPLIED WARRANTY OF MERCHANTABILITY, FITNESS FOR A PARTICULAR PURPOSE, OR NON-INFRINGEMENT. IN NO EVENT SHALL ATMEL BE LIABLE FOR ANY DIRECT, INDIRECT, CONSEQUENTIAL, PUNITIVE, SPECIAL OR INCIDENTAL DAMAGES (INCLUDING, WITHOUT LIMITATION, DAMAGES FOR LOSS AND PROFITS, BUSINESS INTERRUPTION, OR LOSS OF INFORMATION) ARISING OUT OF THE USE OR INABILITY TO USE THIS DOCUMENT, EVEN IF ATMEL HAS BEEN ADVISED OF THE POSSIBILITY OF SUCH DAMAGES. Atmel makes no representations or warranties with respect to the accuracy or completeness of the contents of this document and reserves the right to make changes to specifications and products descriptions at any time without notice. Atmel does not make any commitment to update the information contained herein. Unless specifically provided otherwise, Atmel products are not suitable for, and shall not be used in, automotive applications. Atmel products are not intended, authorized, or warranted for use as components in applications intended to support or sustain life.