



# 80×80×25 mm

San Ace 80W 9WL type  

## General Specifications

- Material ..... Frame: Aluminum (Black coating), Impeller: Plastic (Flammability: UL 94V-1)
- Expected life ..... See the table below. (L10 life: 90% survival rate for continuous operation in indoor free air at 60°C, rated voltage)
- Motor protection function ..... Locked rotor burnout protection, Reverse polarity protection  
For details, please refer to p. 547.
- Dielectric strength ..... 50/60 Hz, 500 VAC, for 1 minute (between lead wire conductors and frame)
- Insulation resistance ..... 10 MΩ or more with a 500 VDC megger (between lead wire conductors and frame)
- Sound pressure level (SPL) ..... At 1 m away from the air inlet
- Storage temperature ..... -30 to +70°C (Non-condensing)
- Lead wire ..... ⊕Red ⊖Black (Sensor) Yellow (Control) Brown  
(For models without PWM control function, there is no speed control wiring.)
- Mass ..... 150 g
- Ingress protection ..... IP68

## Specifications

The models listed below **have pulse sensors with PWM control function.**

Model no.	Rated voltage [V]	Operating voltage range [V]	PWM duty cycle* [%]	Rated current [A]	Rated input [W]	Rated speed [min <sup>-1</sup> ]	Max. airflow [m <sup>3</sup> /min] [CFM]	Max. static pressure [Pa] [inchH <sub>2</sub> O]	SPL [dB (A)]	Operating temperature [°C]	Expected life [h]		
9WL0812P4J001	12	10.8 to 13.2	100	0.6	7.2	7400	2.07 73.0	177 0.71	49	-20 to +70	180000/60°C		
			20	0.06	0.72	1800	0.5 17.6	10.4 0.04	16				
9WL0812P4G001			100	0.3	3.6	5500	1.54 54.3	98 0.39	43				
			25	0.05	0.6	1400	0.39 13.7	6.3 0.02	14				
9WL0812P4H001			100	0.12	1.44	3700	1.03 36.3	44 0.17	31				
			25	0.04	0.48	1100	0.3 10.5	3.9 0.01	13				
9WL0824P4J001			24	21.6 to 26.4	100	0.28	6.72	7400	2.07 73.0			177 0.71	49
					20	0.05	1.2	2400	0.67 23.6			18.6 0.07	22
9WL0824P4G001					100	0.14	3.36	5500	1.54 54.3			98 0.39	43
					20	0.02	0.48	1200	0.33 11.6			4.6 0.01	13
9WL0824P4H001	100	0.05			1.2	3700	1.03 36.3	44 0.17	31				
	30	0.02			0.48	1100	0.3 10.5	3.9 0.01	13				

\* PWM frequency: 25 kHz. Fan does not rotate when PWM duty cycle is 0%.

The following sensor and control options are available for selection.

Differs according to the model. Refer to the table on p. 579. **Without sensor** **Pulse sensor** **Lock sensor**

The models listed below **have pulse sensors.**

Model no.	Rated voltage [V]	Operating voltage range [V]	Rated current [A]	Rated input [W]	Rated speed [min <sup>-1</sup> ]	Max. airflow [m <sup>3</sup> /min] [CFM]	Max. static pressure [Pa] [inchH <sub>2</sub> O]	SPL [dB (A)]	Operating temperature [°C]	Expected life [h]
9WL0812L4001	12	8 to 13.2	0.06	0.72	2300	0.64 22.6	17 0.068	22	-20 to +70	180000/60°C
9WL0824F4001	24	12 to 26.4	0.045	1.08	3300	0.92 32.5	35 0.14	29		

The following sensor and control options are available for selection.

Available for all models. **Without sensor**

## Airflow - Static Pressure Characteristics / PWM Duty - Speed Characteristics Example

**9WL0812P4J001** With pulse sensor with PWM control function

PWM duty cycle

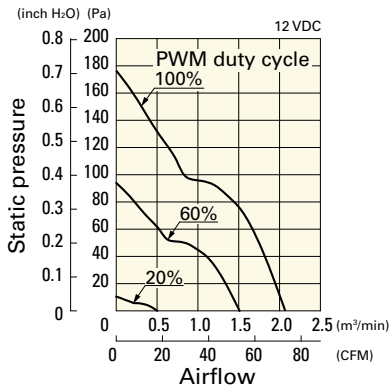

Operating voltage range

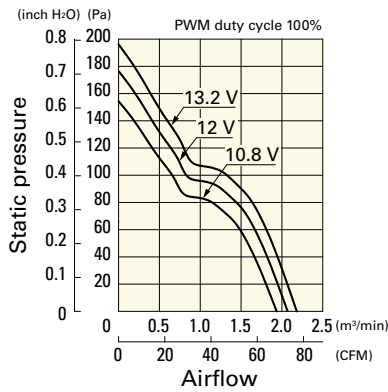

PWM duty - Speed characteristics example

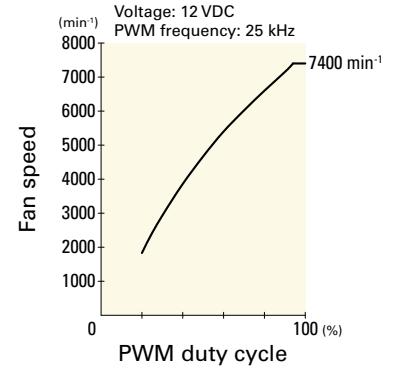

**9WL0812P4G001** With pulse sensor with PWM control function

PWM duty cycle

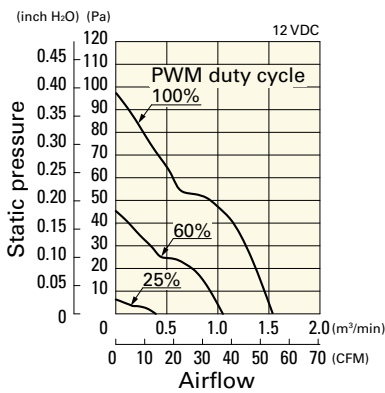

Operating voltage range

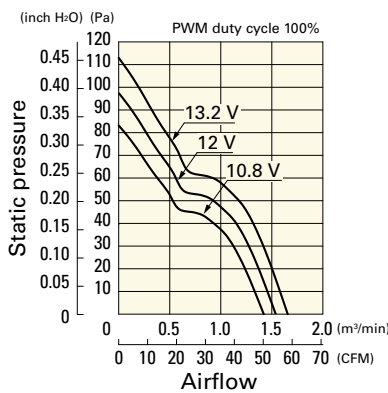

PWM duty - Speed characteristics example

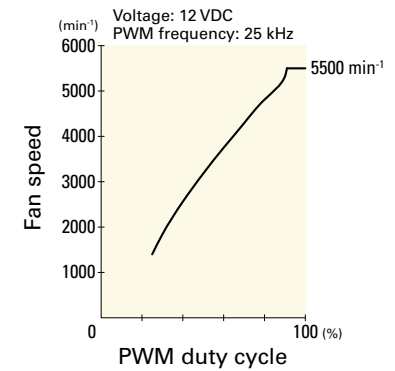

**9WL0812P4H001** With pulse sensor with PWM control function

PWM duty cycle

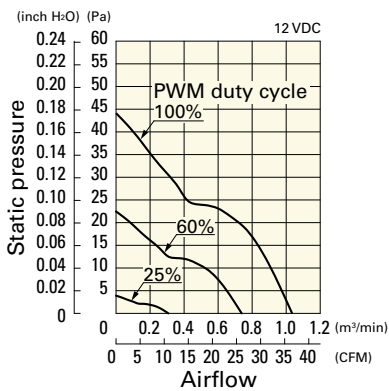

Operating voltage range

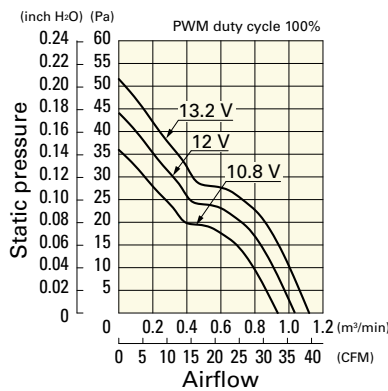

PWM duty - Speed characteristics example

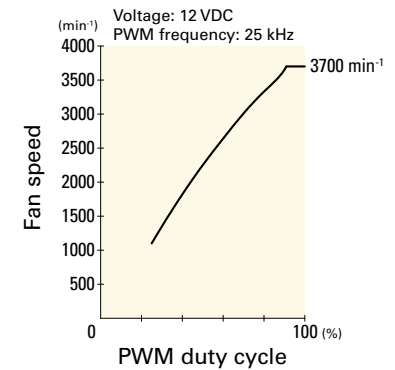

**9WL0824P4J001** With pulse sensor with PWM control function

PWM duty cycle

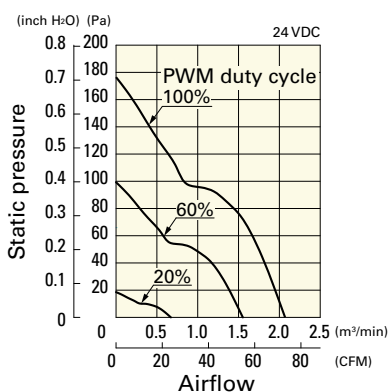

Operating voltage range

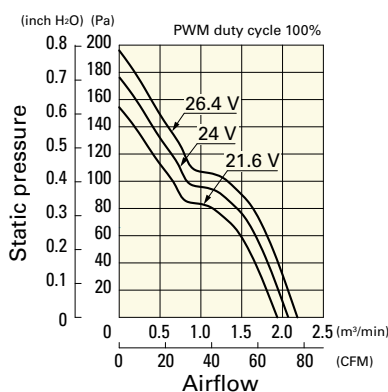

PWM duty - Speed characteristics example

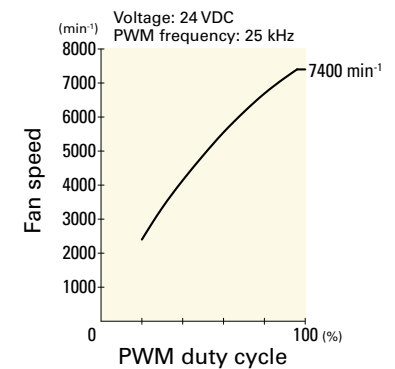

# Airflow - Static Pressure Characteristics / PWM Duty - Speed Characteristics Example

**9WL0824P4G001** With pulse sensor with PWM control function

PWM duty cycle

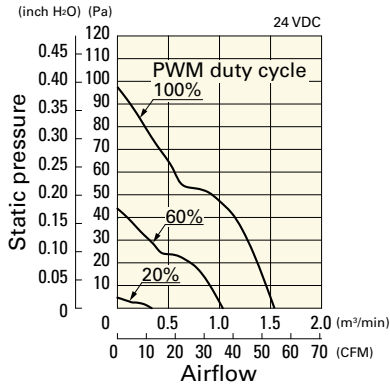

Operating voltage range

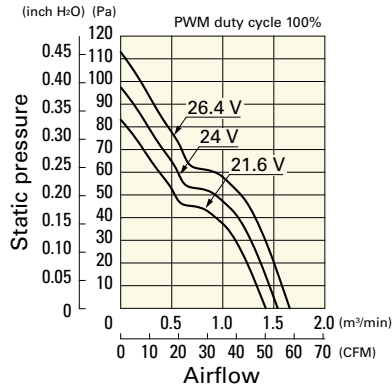

PWM duty - Speed characteristics example

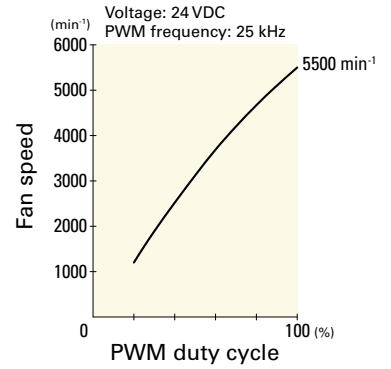

**9WL0824P4H001** With pulse sensor with PWM control function

PWM duty cycle

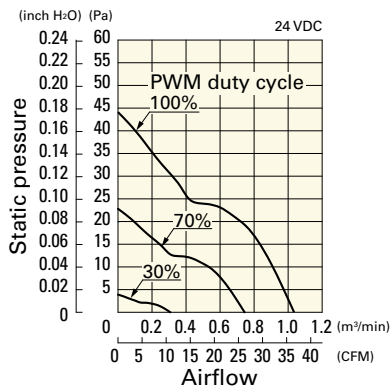

Operating voltage range

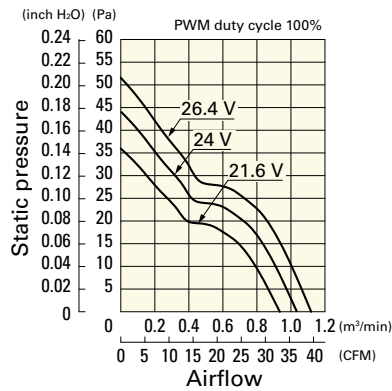

PWM duty - Speed characteristics example

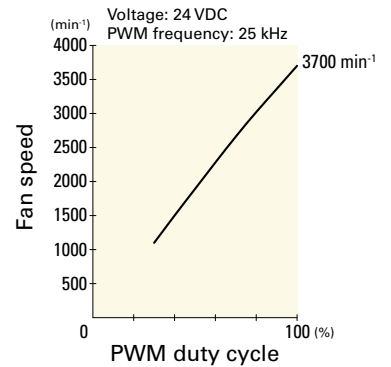

**9WL0812L4001** With pulse sensor

Operating voltage range

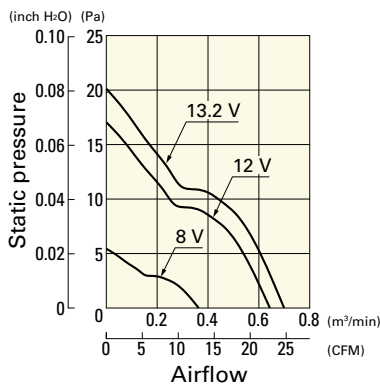

**9WL0824F4001** With pulse sensor

Operating voltage range

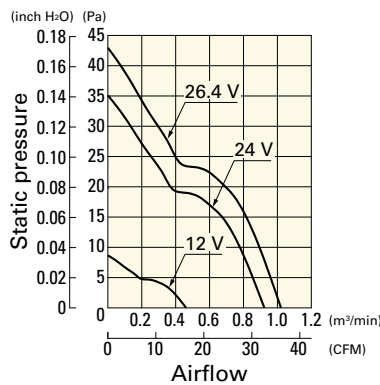

**Dimensions (unit: mm)**

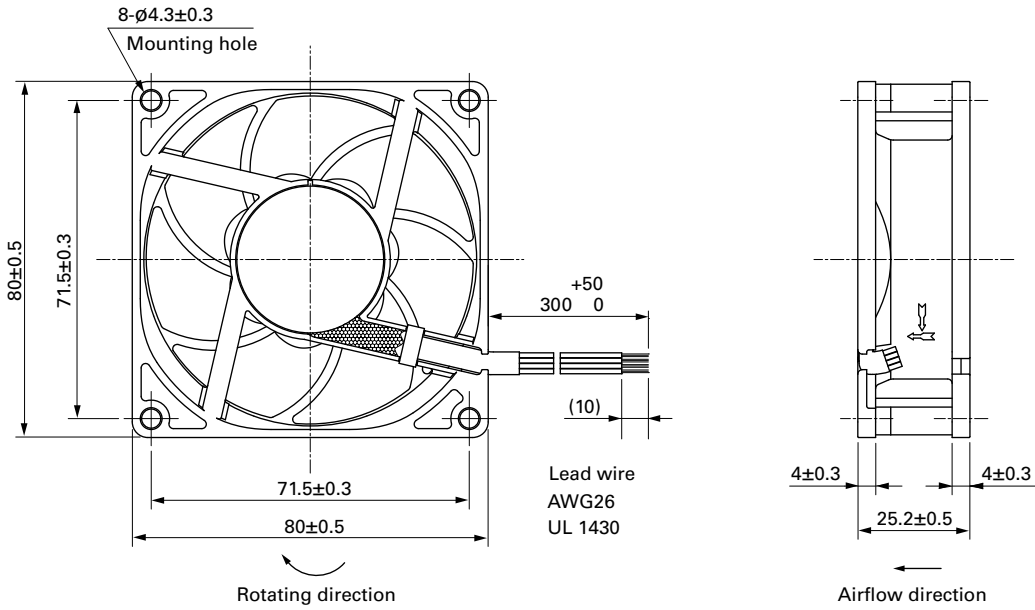

**Reference Dimensions of Mounting Holes and Vent Opening (unit: mm)**

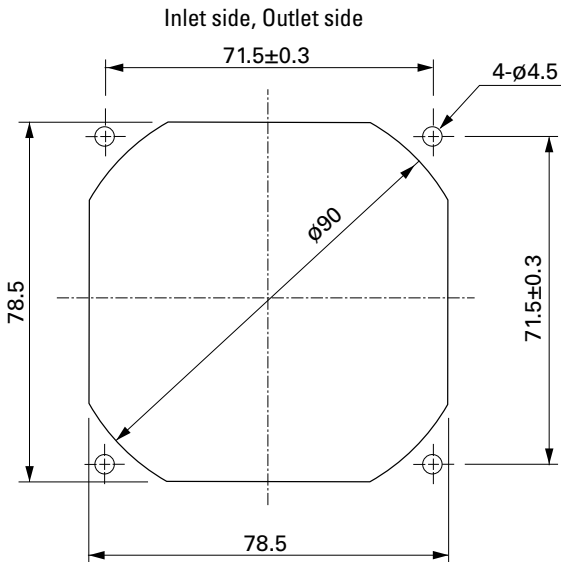

**Options**

**Finger guards**

page: p. 532

Model no.: 109-049E, 109-049H, 109-049C

**Resin finger guards**

page: p. 539

Model no.: 109-1002G