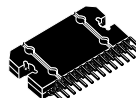


## MULTIFUNCTION QUAD POWER AMPLIFIER WITH BUILT-IN DIAGNOSTICS FEATURES

- DMOS POWER OUTPUT
- HIGH OUTPUT POWER CAPABILITY 4x25W/4Ω @ 14.4V, 1KHZ, 10% THD, 4x35W EIAJ
- MAX. OUTPUT POWER 4x60W/2Ω
- FULL I<sup>2</sup>C BUS DRIVING:
  - ST-BY
  - INDEPENDENT FRONT/REAR SOFT PLAY/MUTE
  - SELECTABLE GAIN 30dB - 16dB (FOR LOW NOISE LINE OUTPUT FUNCTION)
  - I<sup>2</sup>C BUS DIGITAL DIAGNOSTICS
- FULL FAULT PROTECTION
- DC OFFSET DETECTION
- FOUR INDEPENDENT SHORT CIRCUIT PROTECTION
- CLIPPING DETECTOR PIN WITH SELECTABLE THRESHOLD (2%/10%)
- ST-BY/MUTE PIN
- ESD PROTECTION

**MULTIPOWER BCD TECHNOLOGY**

**MOSFET OUTPUT POWER STAGE**



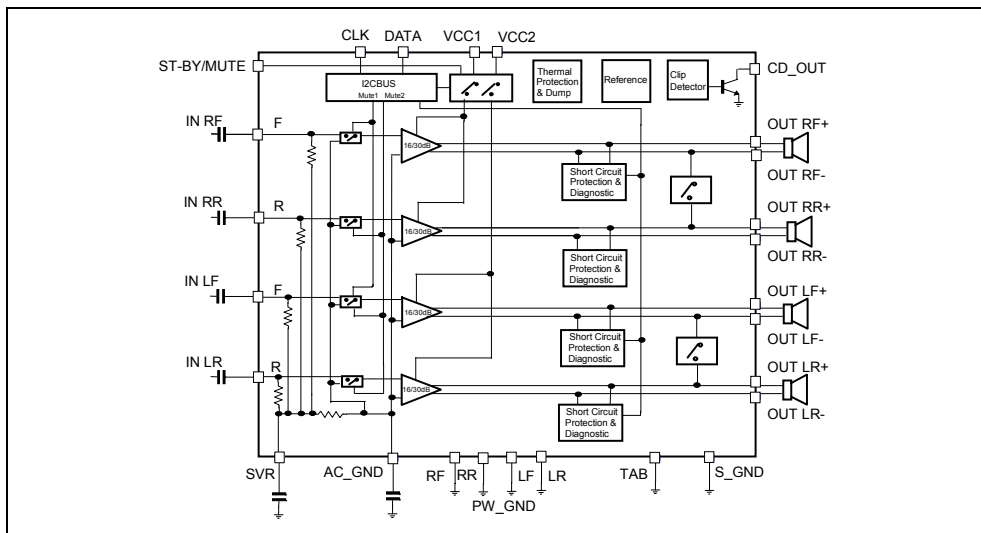
**FLEXIWATT27 (Vertical)**

Bridge type of car radio amplifier in Flexiwatt27V package specially intended for car radio applications. Thanks to the DMOS output stage the TDA7562 has a very low distortion allowing a clear powerful sound. This device is equipped with a full diagnostics array that communicates the status of each speaker through the I<sup>2</sup>C bus. The possibility to control the configuration and the behaviour of the device by means of the I<sup>2</sup>C bus makes TDA7562 a very flexible machine.

### DESCRIPTION

The TDA7562 is a new BCD technology Quad

### BLOCK DIAGRAM



## ABSOLUTE MAXIMUM RATINGS

Symbol	Parameter	Value	Unit
$V_{op}$	Operating Supply Voltage	18	V
$V_S$	DC Supply Voltage	28	V
$V_{peak}$	Peak Supply Voltage (for $t = 50ms$ )	50	V
$V_{CK}$	CK pin Voltage	6	V
$V_{DATA}$	Data Pin Voltage	6	V
$I_o$	Output Peak Current (not repetitive $t = 100\mu s$ )	8	A
$I_o$	Output Peak Current (repetitive $f > 10Hz$ )	6	A
$P_{tot}$	Power Dissipation $T_{case} = 70^\circ C$	85	W
$T_{stg}, T_j$	Storage and Junction Temperature	-55 to 150	$^\circ C$

## THERMAL DATA

Symbol	Parameter	Value	Unit
$R_{th\ j-case}$	Thermal Resistance Junction to case	Max. 1	$^\circ C/W$

## PIN CONNECTION (Top view)

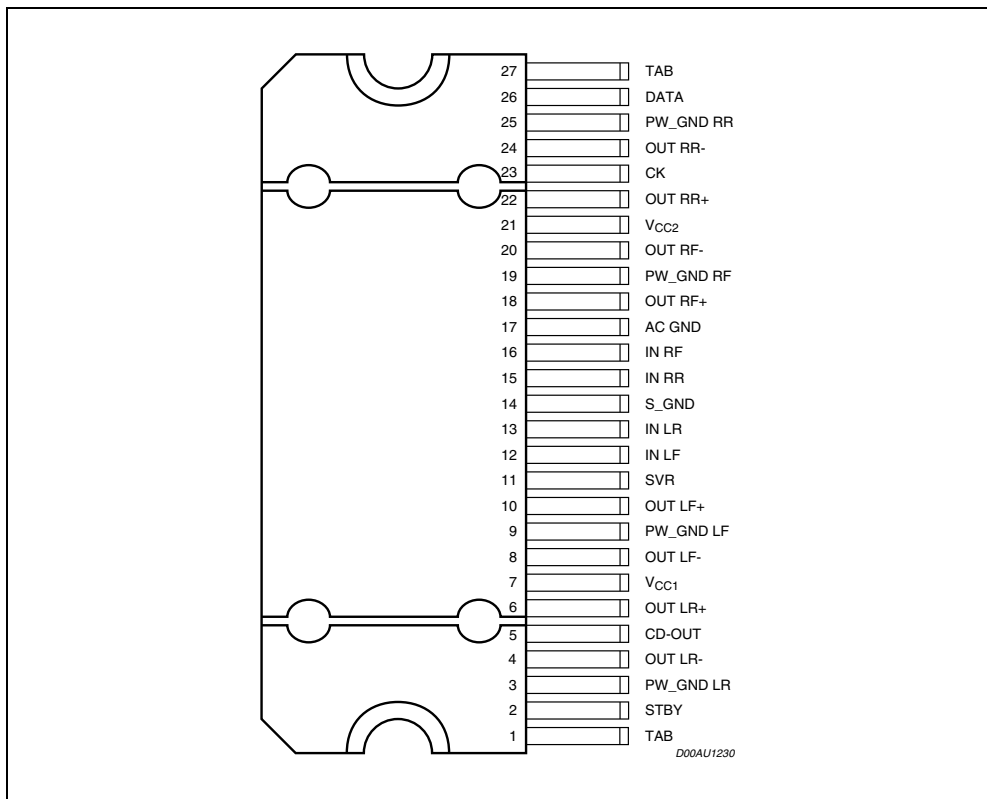
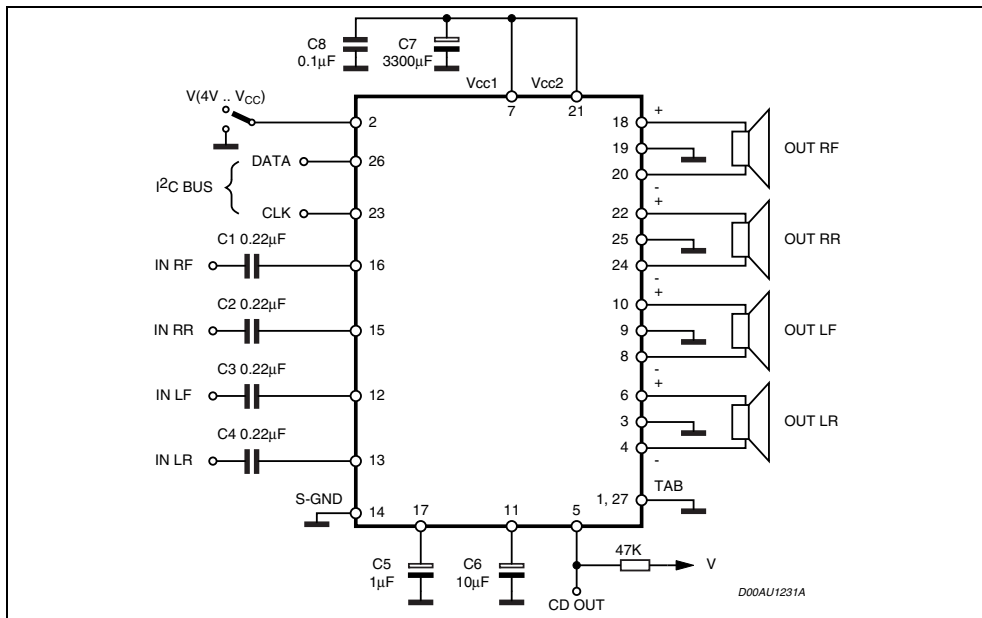


Figure 1. Application Circuit



## ELECTRICAL CHARACTERISTICS

(Refer to the test circuit,  $V_S = 14.4V$ ;  $R_L = 4\Omega$ ;  $f = 1KHz$ ;  $T_{amb} = 25^\circ C$ ; unless otherwise specified.)

Symbol	Parameter	Test Condition	Min.	Typ.	Max.	Unit
<b>POWER AMPLIFIER</b>						
$V_S$	Supply Voltage Range		8		18	V
$I_d$	Total Quiescent Drain Current			150	300	mA
$P_O$	Output Power	EIAJ ( $V_S = 13.7V$ )	32	35		W
		THD = 10%	22	25		W
		THD = 1%		20		W
		$R_L = 2\Omega$ ; EIAJ ( $V_S = 13.7V$ )	50	55		W
		$R_L = 2\Omega$ ; THD 10%	32	38		W
	$R_L = 2\Omega$ ; THD 1%		30		W	
	$R_L = 2\Omega$ ; MAX POWER		60		W	
THD	Total Harmonic Distortion	$P_O = 1W$ to $10W$ ; $f = 1kHz$		0.04	0.1	%
		$P_O = 1-10W$ , $f = 10kHz$		0.02	0.5	%
		$G_V = 16dB$ ; $V_O = 0.1$ to $5V_{RMS}$		0.02	0.05	%
$C_T$	Cross Talk	$f = 1KHz$ to $10KHz$ , $R_g = 600\Omega$	50	60		dB
$R_{IN}$	Input Impedance		60	100	130	$K\Omega$
$G_{V1}$	Voltage Gain 1		29.5	30	30.5	dB
$\Delta G_{V1}$	Voltage Gain Match 1		-1		1	dB
$G_{V2}$	Voltage Gain 2		15.5	16	16.5	dB
$\Delta G_{V2}$	Voltage Gain Match 2		-1		1	dB
$E_{IN1}$	Output Noise Voltage 1	$R_g = 600\Omega$ 20Hz to 22kHz		50	100	$\mu V$
$E_{IN2}$	Output Noise Voltage 2	$R_g = 600\Omega$ ; $G_V = 16dB$ 20Hz to 22kHz		15	30	$\mu V$
SVR	Supply Voltage Rejection	$f = 100Hz$ to $10kHz$ ; $V_r = 1V_{pk}$ ; $R_g = 600\Omega$	50	60		dB
BW	Power Bandwidth		100			KHz
$A_{SB}$	Stand-by Attenuation		90	110		dB
$I_{SB}$	Stand-by Current			2	100	$\mu A$
$A_M$	Mute Attenuation		80	100		dB
$V_{OS}$	Offset Voltage	Mute & Play	-100	0	100	mV
$V_{AM}$	Min. Supply Mute Threshold		7	7.5	8	V
$T_{ON}$	Turn ON Delay	D2/D1 (IB1) 0 to 1		5	20	ms
$T_{OFF}$	Turn OFF Delay	D2/D1 (IB1) 1 to 0		5	20	ms
$V_{SBY}$	St-By/Mute pin for St-By		0		1.5	V
$V_{MU}$	St-By/Mute pin for Mute		3.5		5	V
$V_{OP}$	St-By/Mute pin for Operating		7		$V_S$	V
$I_{MU}$	St-By/Mute pin Current	$V_{STBY/MUTE} = 8.5V$		20	40	$\mu A$
		$V_{STBY/MUTE} < 1.5V$		0	10	$\mu A$
$CD_{LK}$	Clip Det High Leakage Current	CD off		0	15	$\mu A$
$CD_{SAT}$	Clip Det Sat. Voltage	CD on; $I_{CD} = 1mA$		300		mV
$CD_{THD}$	Clip Det THD level	D0 (IB1) = 1	5	10	15	%
		D0 (IB1) = 0	1	2	3	%

**ELECTRICAL CHARACTERISTICS** (continued)(Refer to the test circuit,  $V_S = 14.4V$ ;  $R_L = 4\Omega$ ;  $f = 1KHz$ ;  $T_{amb} = 25^\circ C$ ; unless otherwise specified.)

Symbol	Parameter	Test Condition	Min.	Typ.	Max.	Unit
<b>DIAGNOSTICS (Power Amplifier Mode or Line Driver Mode)</b>						
Pgnd	Short to GND det. (below this limit, the Output is considered in Short Circuit to GND)	Power Amplifier in Mute or Play, one or more short circuits protection activated			1.2	V
Pvs	Short to $V_S$ det. (above this limit, the Output is considered in Short Circuit to $V_S$ )		$V_S - 1.2$			V
Pnop	Normal operation thresholds. (Within these limits, the Output is considered without faults).		1.8		$V_S - 1.8$	V
Lsc	Shorted Load det.	Power Amplifier Mode			0.5	$\Omega$
		Line Driver Mode			1.5	$\Omega$
$V_O$	Offset Detection		$\pm 1.5$	$\pm 2$	$\pm 2.5$	V
<b>I<sup>2</sup>C BUS INTERFACE</b>						
$f_{SCL}$	Clock Frequency			400		KHz
$V_{IL}$	Input Low Voltage				1.5	V
$V_{IH}$	Input High Voltage		2.3			V

Figure 2. Quiescent Current vs. Supply Voltage

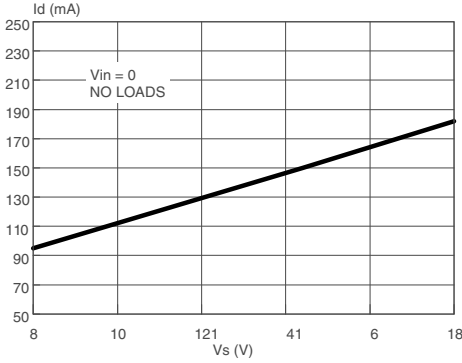


Figure 3. Output Power vs. Supply Voltage (4Ω)

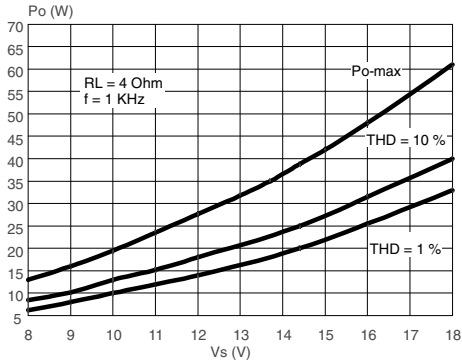


Figure 4. Output Power vs. Supply Voltage (2Ω)

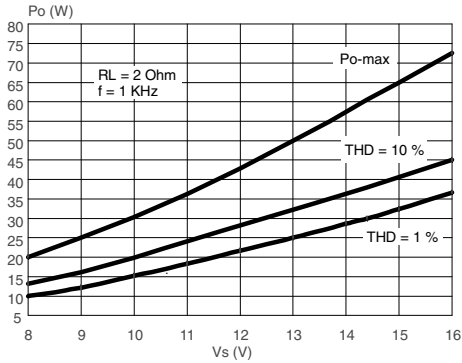


Figure 5. Distortion vs. Output Power (4Ω)

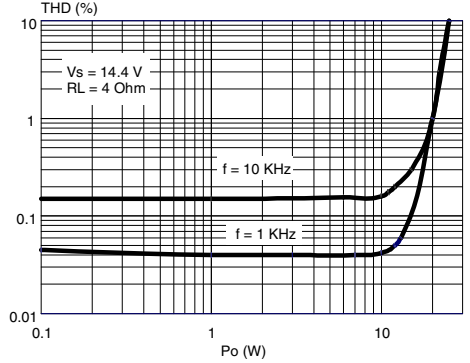


Figure 6. Distortion vs. Output Power (2Ω)

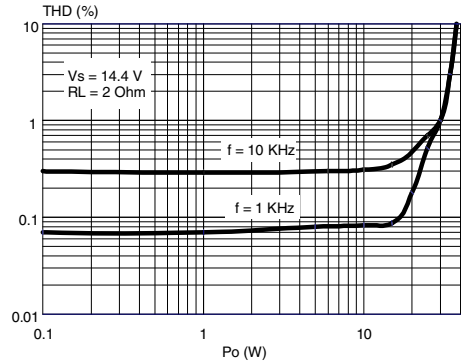


Figure 7. Distortion vs. Output Power (4Ω)

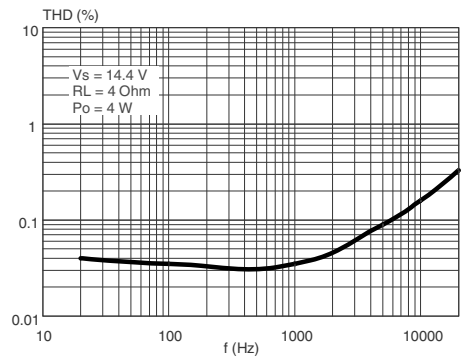


Figure 8. Distortion vs. Frequency (2Ω)

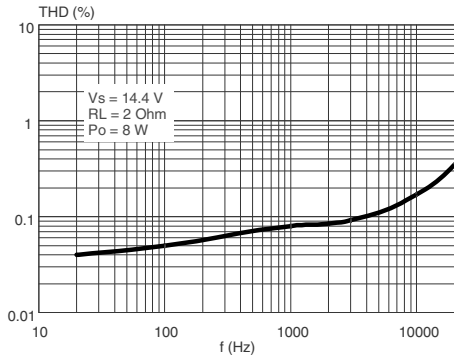


Figure 9. Crosstalk vs. Frequency

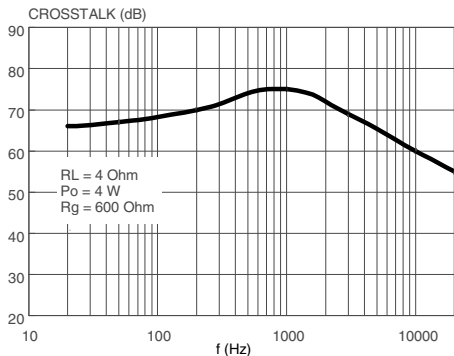


Figure 10. Supply Voltage Rejection vs. Freq.

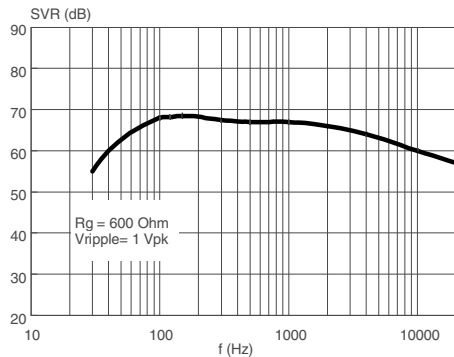


Figure 11. Power Dissipation & Efficiency vs. Output Power (4Ω, STD, SINE)

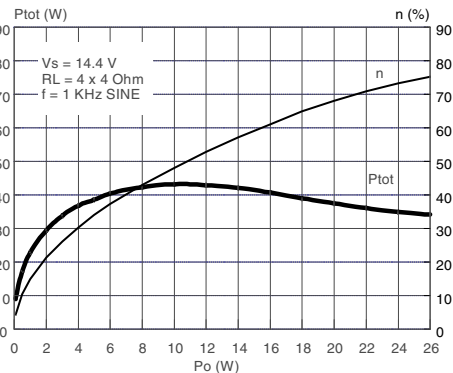


Figure 12. Power Dissipation vs. Average Output Power (Audio Program Simulation, 4Ω)

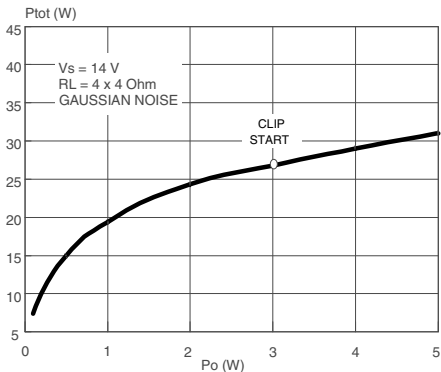
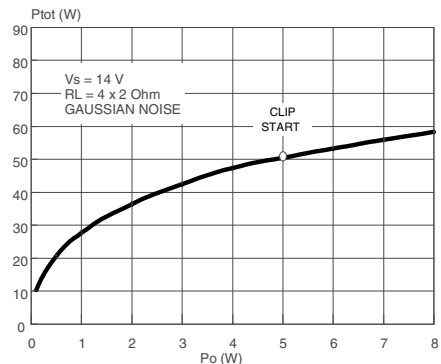


Figure 13. Power Dissipation vs. Average Output Power (Audio Program Simulation, 2Ω)



**DIAGNOSTICS FUNCTIONAL DESCRIPTION:**

Detectable conventional faults are:

- SHORT TO GND
- SHORT TO V<sub>s</sub>
- SHORT ACROSS THE SPEAKER

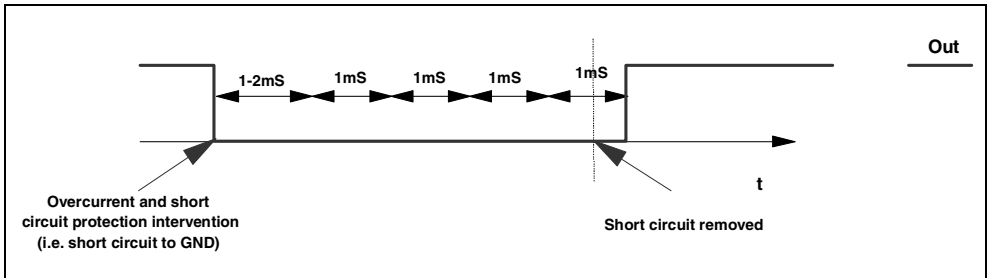
The following additional features are provided:

- OUTPUT OFFSET DETECTION

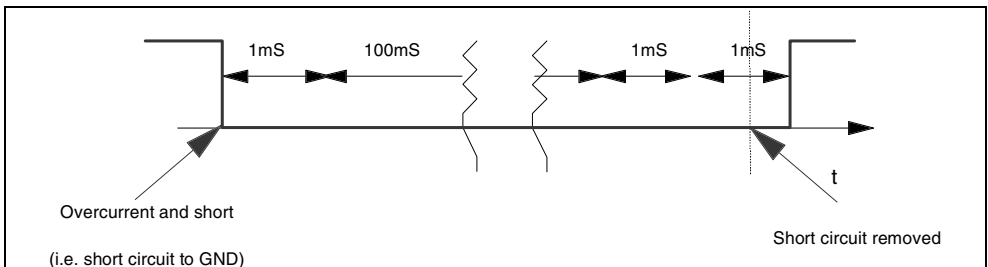
The TDA7562 has 2 operating statuses:

- 1)) RESTART mode. The diagnostic is not enabled. Each audio channel operates independently from each other. If any of the a.m. faults occurs, only the channel(s) interested is shut down. A check of the output status is made every 1 ms (fig. 14). Restart takes place when the overload is removed.
- 2)) DIAGNOSTIC mode. It is enabled via I2C bus and self activates if an output overload (such to cause the intervention of the short-circuit protection) occurs to the speakers outputs . Once activated, the diagnostics procedure develops as follows (fig. 15):
  - To avoid momentary re-circulation spikes from giving erroneous diagnostics, a check of the output status is made after 1ms: if normal situation (no overloads) is detected, the diagnostic is not performed and the channel returns back active.
  - Instead, if an overload is detected during the check after 1 ms, then a diagnostic cycle having a duration of about 100 ms is started.
  - After a diagnostic cycle, the audio channel interested by the fault is switched to RESTART mode. The relevant data are stored inside the device and can be read by the microprocessor. When one cycle has terminated, the next one is activated by an I2C reading. This is to ensure continuous diagnostics throughout the car-radio operating time.
  - To check the status of the device a sampling system is needed. The timing is chosen at microprocessor level (over half a second is recommended).

**Figure 14. Restart timing without Diagnostic Enable** (Each 1mS time, a sampling of the fault is done)

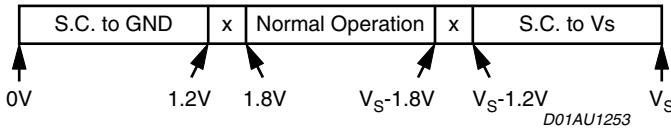


**Figure 15. Restart timing with Diagnostic Enable**

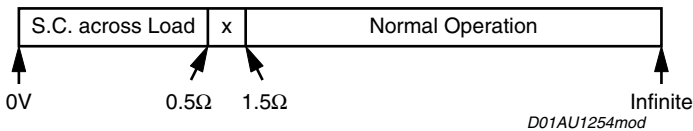




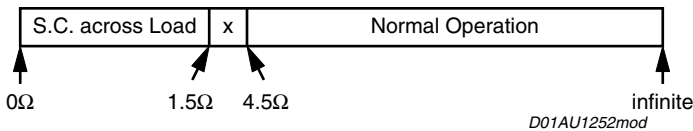
As for SHORT TO GND /  $V_S$  the fault-detection thresholds remain unchanged from 30 dB to 16 dB gain setting. They are as follows:



Concerning SHORT ACROSS THE SPEAKER, the threshold varies from 30 dB to 16 dB gain setting, since different loads are expected (either normal speaker's impedance or high impedance). The values in case of 30 dB gain are as follows:



If the Line-Driver mode ( $G_v = 16$  dB and Line Driver Mode diagnostic = 1) is selected, the same thresholds will change as follows:



## OUTPUT DC OFFSET DETECTION

Any DC output offset exceeding  $\pm 2V$  are signalled out. This inconvenient might occur as a consequence of initially defective or aged and worn-out input capacitors feeding a DC component to the inputs, so putting the speakers at risk of overheating.

This diagnostic has to be performed with low-level output AC signal (or  $V_{in} = 0$ ).

The test is run with selectable time duration by microprocessor (from a "start" to a "stop" command):

- START = Last reading operation or setting IB1 - D5 - (OFFSET enable) to 1
- STOP = Actual reading operation

Excess offset is signalled out if persistent throughout the assigned testing time. This feature is disabled if any overloads leading to activation of the short-circuit protection occurs in the process.

## MULTIPLE FAULTS

When more misconnections are simultaneously in place at the audio outputs, it is guaranteed that at least one of them is initially read out. The others are notified after successive cycles of I<sup>2</sup>C reading and faults removal, provided that the diagnostic is enabled.

The table below shows all the couples of double-fault possible. It should be taken into account that a short circuit

with the 4 ohm speaker unconnected is considered as double fault.

Double fault table for Turn On Diagnostic				
	S. GND (so)	S. GND (sk)	S. Vs	S. Across L.
S. GND (so)	S. GND	S. GND	S. Vs + S. GND	S. GND
S. GND (sk)	/	S. GND	S. Vs	S. GND
S. Vs	/	/	S. Vs	S. Vs
S. Across L.	/	/	/	S. Across L.

S. GND (so) / S. GND (sk) in the above table make a distinction according to which of the 2 outputs is shorted to ground (test-current source side= so, test-current sink side = sk). More precisely, so = CH+, sk = CH-.

### FAULTS AVAILABILITY

All the results coming from I2Cbus, by read operations, are the consequence of measurements inside a defined period of time. If the fault is stable throughout the whole period, it will be sent out.

To guarantee always resident functions, every kind of diagnostic cycles will be reactivate after any I<sup>2</sup>C reading operation. So, when the micro reads the I<sup>2</sup>C, a new cycle will be able to start, but the read data will come from the previous diag. cycle (i.e. The device is in turned On, with a short to Gnd, then the short is removed and micro reads I<sup>2</sup>C. The short to Gnd is still present in bytes, because it is the result of the previous cycle. If another I<sup>2</sup>C reading operation occurs, the bytes do not show the short). In general to observe a change in Diagnostic bytes, two I<sup>2</sup>C reading operations are necessary.

### I<sup>2</sup>C PROGRAMMING/READING SEQUENCES

A correct turn on/off sequence respectful of the diagnostic timings and producing no audible noises could be as follows (after battery connection):

TURN-ON: PIN2 > 7V --- 10ms --- (STAND-BY OUT + DIAG ENABLE) --- 500 ms (min) --- MUTING OUT

TURN-OFF: MUTING IN --- 20 ms --- (DIAG DISABLE + STAND-BY IN) --- 10ms --- PIN2 = 0

Car Radio Installation: PIN2 > 7V --- 10ms DIAG ENABLE (write) --- 200 ms --- I<sup>2</sup>C read (repeat until All faults disappear).

OFFSET TEST: Device in Play (no signal) -- OFFSET ENABLE - 30ms - I<sup>2</sup>C reading (repeat I<sup>2</sup>C reading until high-offset message disappears).

### FAST MUTING

The muting time can be shortened to less than 1ms by setting (IB2) D5 = 1. This option can be useful in transient battery situations (i.e. during car engine cranking) to quickly turnoff the amplifier for avoiding any audible effects caused by noise/transients being injected by preamp stages.

## I<sup>2</sup>C BUS INTERFACE

Data transmission from microprocessor to the TDA7562 and viceversa takes place through the 2 wires I<sup>2</sup>C BUS interface, consisting of the two lines SDA and SCL (pull-up resistors to positive supply voltage must be connected).

### Data Validity

As shown by fig. 16, the data on the SDA line must be stable during the high period of the clock. The HIGH and LOW state of the data line can only change when the clock signal on the SCL line is LOW.

### Start and Stop Conditions

As shown by fig. 17 a start condition is a HIGH to LOW transition of the SDA line while SCL is HIGH. The stop condition is a LOW to HIGH transition of the SDA line while SCL is HIGH.

### Byte Format

Every byte transferred to the SDA line must contain 8 bits. Each byte must be followed by an acknowledge bit. The MSB is transferred first.

### Acknowledge

The transmitter\* puts a resistive HIGH level on the SDA line during the acknowledge clock pulse (see fig. 18). The receiver\*\* the acknowledges has to pull-down (LOW) the SDA line during the acknowledge clock pulse, so that the SDA line is stable LOW during this clock pulse.

\* Transmitter

- master ( $\mu$ P) when it writes an address to the TDA7562
- slave (TDA7562) when the  $\mu$ P reads a data byte from TDA7562

\*\* Receiver

- slave (TDA7562) when the  $\mu$ P writes an address to the TDA7562
- master ( $\mu$ P) when it reads a data byte from TDA7562

Figure 16. Data Validity on the I<sup>2</sup>C BUS

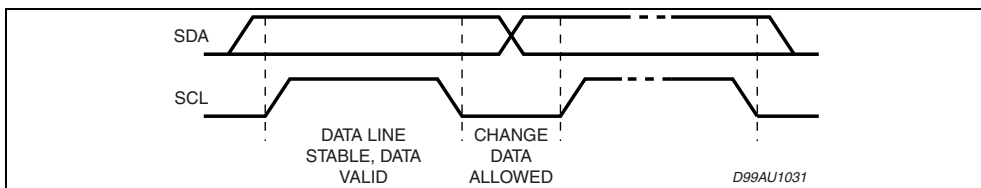


Figure 17. Timing Diagram on the I<sup>2</sup>C BUS

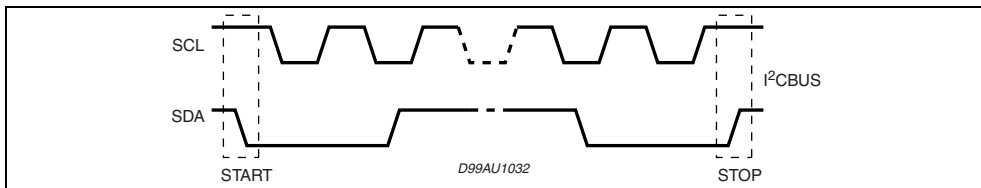
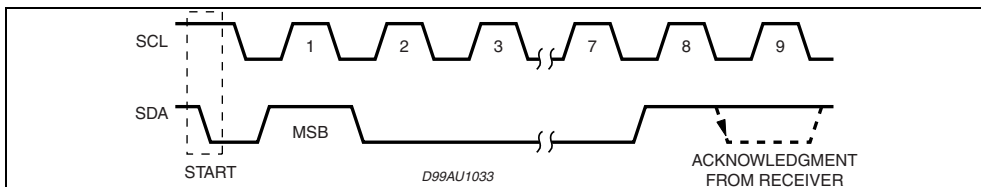


Figure 18. Acknowledge on the I<sup>2</sup>C BUS



## SOFTWARE SPECIFICATIONS

All the functions of the TDA7562 are activated by I<sup>2</sup>C interface.

The bit 0 of the "ADDRESS BYTE" defines if the next bytes are write instruction (from  $\mu$ P to TDA7562) or read instruction (from TDA7562 to  $\mu$ P).

Chip Address:

<b>D7</b>	1	1	0	1	1	0	0	<b>D0</b> X	D8 Hex
-----------	---	---	---	---	---	---	---	----------------	--------

X = 0 Write to device

X = 1 Read from device

If R/W = 0, the  $\mu$ P sends 2 "Instruction Bytes": IB1 and IB2.

## IB1

<b>D7</b>	X
<b>D6</b>	Diagnostic enable (D6 = 1) Diagnostic defeat (D6 = 0)
<b>D5</b>	Offset Detection enable (D5 = 1) Offset Detection defeat (D5 = 0)
<b>D4</b>	Front Channel Gain = 30dB (D4 = 0) Gain = 16dB (D4 = 1)
<b>D3</b>	Rear Channel Gain = 30dB (D3 = 0) Gain = 16dB (D3 = 1)
<b>D2</b>	Mute front channels (D2 = 0) Unmute front channels (D2 = 1)
<b>D1</b>	Mute rear channels (D1 = 0) Unmute rear channels (D1 = 1)
<b>D0</b>	CD 2% (D0 = 0) CD 10% (D0 = 1)

## IB2

<b>D7</b>	X
<b>D6</b>	used for testing
<b>D5</b>	Normal muting time (D5 = 0) Fast muting time (D5 = 1)
<b>D4</b>	Stand-by on - Amplifier not working - (D4 = 0) Stand-by off - Amplifier working - (D4 = 1)
<b>D3</b>	Power amplifier mode diagnostic (D3 = 0) Line driver mode diagnostic (D3 = 1)
<b>D2</b>	X
<b>D1</b>	X
<b>D0</b>	X

If R/W = 1, the TDA7562 sends 4 "Diagnostics Bytes" to  $\mu$ P: DB1, DB2, DB3 and DB4.

**DB1**

<b>D7</b>	Thermal warning active (D7 = 1)
<b>D6</b>	Diag. cycle not activated or not terminated (D6 = 0) Diag. cycle terminated (D6 = 1)
<b>D5</b>	X
<b>D4</b>	X
<b>D3</b>	Channel LF Normal load (D3 = 0) Short load (D3 = 1)
<b>D2</b>	Channel LF No output offset (D2 = 0) Output offset detection (D2 = 1)
<b>D1</b>	Channel LF No short to Vcc (D1 = 0) Short to Vcc (D1 = 1)
<b>D0</b>	Channel LF No short to GND (D1 = 0) Short to GND (D1 = 1)

**DB2**

<b>D7</b>	Offset detection not activated (D7 = 0) Offset detection activated (D7 = 1)
<b>D6</b>	X
<b>D5</b>	X
<b>D4</b>	X
<b>D3</b>	Channel LR Normal load (D3 = 0) Short load (D3 = 1)
<b>D2</b>	Channel LR No output offset (D2 = 0) Output offset detection (D2 = 1)
<b>D1</b>	Channel LR No short to Vcc (D1 = 0) Short to Vcc (D1 = 1)
<b>D0</b>	Channel LR No short to GND (D1 = 0) Short to GND (D1 = 1)

## B3

<b>D7</b>	Stand-by status (= IB1 - D4)
<b>D6</b>	Diagnostic status (= IB1 - D6)
<b>D5</b>	X
<b>D4</b>	Channel RF Turn-on diagnostic (D4 = 0) X
<b>D3</b>	Channel RF Normal load (D3 = 0) Short load (D3 = 1)
<b>D2</b>	Channel RF No output offset (D2 = 0) Output offset detection (D2 = 1)
<b>D1</b>	Channel RF No short to Vcc (D1 = 0) Short to Vcc (D1 = 1)
<b>D0</b>	Channel RF No short to GND (D1 = 0) Short to GND (D1 = 1)

## DB4

<b>D7</b>	X
<b>D6</b>	X
<b>D5</b>	X
<b>D4</b>	X
<b>D3</b>	Channel RR RNormal load (D3 = 0) Short load (D3 = 1)
<b>D2</b>	Channel RR No output offset (D2 = 0) Output offset detection (D2 = 1)
<b>D1</b>	Channel RR No short to Vcc (D1 = 0) Short to Vcc (D1 = 1)
<b>D0</b>	Channel RR No short to GND (D1 = 0) Short to GND (D1 = 1)

**Examples of bytes sequence**

1 - Turn-On of the power amplifier with 30dB gain, mute on, diagnostic defeat, CD = 2%.

Start	Address byte with D0 = 0	ACK	IB1	ACK	IB2	ACK	STOP
			X0000000		XXX1XX11		

2 - Turn-Off of the power amplifier

Start	Address byte with D0 = 0	ACK	IB1	ACK	IB2	ACK	STOP
			X0XXXXXX		XXX0XXXX		

3 - Offset detection procedure enable

Start	Address byte with D0 = 0	ACK	IB1	ACK	IB2	ACK	STOP
			XX1XX11X		XXX1XXXX		

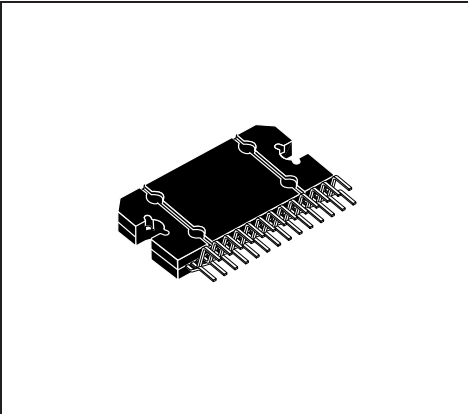
4 - Offset detection procedure stop and reading operation (the results are valid only for the offset detection bits (D2 of the bytes DB1, DB2, DB3, DB4).

Start	Address byte with D0 = 1	ACK	DB1	ACK	DB2	ACK	DB3	ACK	DB4	ACK	STOP
-------	--------------------------	-----	-----	-----	-----	-----	-----	-----	-----	-----	------

- The purpose of this test is to check if a D.C. offset (2V typ.) is present on the outputs, produced by input capacitor with anomalous leakage current or humidity between pins.
- The delay from 4 to 5 can be selected by software, starting from T.B.D. ms

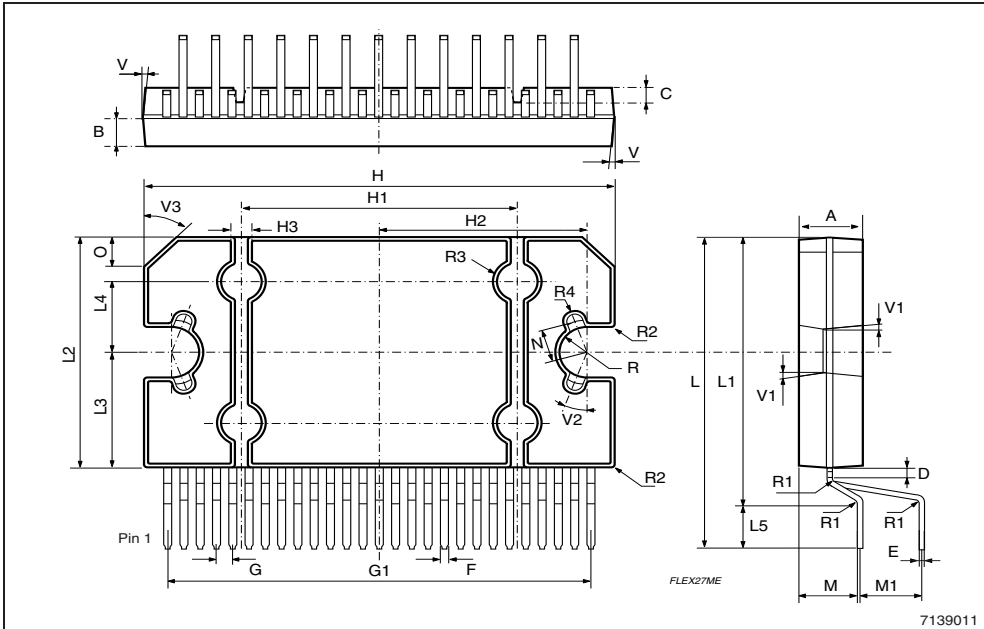
DIM.	mm			inch		
	MIN.	TYP.	MAX.	MIN.	TYP.	MAX.
A	4.45	4.50	4.65	0.175	0.177	0.183
B	1.80	1.90	2.00	0.070	0.074	0.079
C		1.40			0.055	
D	0.75	0.90	1.05	0.029	0.035	0.041
E	0.37	0.39	0.42	0.014	0.015	0.016
F (1)			0.57			0.022
G	0.80	1.00	1.20	0.031	0.040	0.047
G1	25.75	26.00	26.25	1.014	1.023	1.033
H (2)	28.90	29.23	29.30	1.139	1.150	1.153
H1		17.00			0.669	
H2		12.80			0.503	
H3		0.80			0.031	
L (2)	22.07	22.47	22.87	0.869	0.884	0.904
L1	18.57	18.97	19.37	0.731	0.747	0.762
L2 (2)	15.50	15.70	15.90	0.610	0.618	0.626
L3	7.70	7.85	7.95	0.303	0.309	0.313
L4		5			0.197	
L5		3.5			0.138	
M	3.70	4.00	4.30	0.145	0.157	0.169
M1	3.60	4.00	4.40	0.142	0.157	0.173
N		2.20			0.086	
O		2			0.079	
R		1.70			0.067	
R1		0.5			0.02	
R2		0.3			0.12	
R3		1.25			0.049	
R4		0.50			0.019	
V	5° (Typ.)					
V1	3° (Typ.)					
V2	20° (Typ.)					
V3	45° (Typ.)					

**OUTLINE AND MECHANICAL DATA**



**Flexiwatt27 (vertical)**

- (1): dam-bar protusion not included
- (2): molding protusion included



7139011





**Please Read Carefully:**

Information in this document is provided solely in connection with ST products. STMicroelectronics NV and its subsidiaries ("ST") reserve the right to make changes, corrections, modifications or improvements, to this document, and the products and services described herein at any time, without notice.

All ST products are sold pursuant to ST's terms and conditions of sale.

Purchasers are solely responsible for the choice, selection and use of the ST products and services described herein, and ST assumes no liability whatsoever relating to the choice, selection or use of the ST products and services described herein.

No license, express or implied, by estoppel or otherwise, to any intellectual property rights is granted under this document. If any part of this document refers to any third party products or services it shall not be deemed a license grant by ST for the use of such third party products or services, or any intellectual property contained therein or considered as a warranty covering the use in any manner whatsoever of such third party products or services or any intellectual property contained therein.

**UNLESS OTHERWISE SET FORTH IN ST'S TERMS AND CONDITIONS OF SALE ST DISCLAIMS ANY EXPRESS OR IMPLIED WARRANTY WITH RESPECT TO THE USE AND/OR SALE OF ST PRODUCTS INCLUDING WITHOUT LIMITATION IMPLIED WARRANTIES OF MERCHANTABILITY, FITNESS FOR A PARTICULAR PURPOSE (AND THEIR EQUIVALENTS UNDER THE LAWS OF ANY JURISDICTION), OR INFRINGEMENT OF ANY PATENT, COPYRIGHT OR OTHER INTELLECTUAL PROPERTY RIGHT.**

**ST PRODUCTS ARE NOT DESIGNED OR AUTHORIZED FOR USE IN: (A) SAFETY CRITICAL APPLICATIONS SUCH AS LIFE SUPPORTING, ACTIVE IMPLANTED DEVICES OR SYSTEMS WITH PRODUCT FUNCTIONAL SAFETY REQUIREMENTS; (B) AERONAUTIC APPLICATIONS; (C) AUTOMOTIVE APPLICATIONS OR ENVIRONMENTS, AND/OR (D) AEROSPACE APPLICATIONS OR ENVIRONMENTS. WHERE ST PRODUCTS ARE NOT DESIGNED FOR SUCH USE, THE PURCHASER SHALL USE PRODUCTS AT PURCHASER'S SOLE RISK, EVEN IF ST HAS BEEN INFORMED IN WRITING OF SUCH USAGE, UNLESS A PRODUCT IS EXPRESSLY DESIGNATED BY ST AS BEING INTENDED FOR "AUTOMOTIVE, AUTOMOTIVE SAFETY OR MEDICAL" INDUSTRY DOMAINS ACCORDING TO ST PRODUCT DESIGN SPECIFICATIONS. PRODUCTS FORMALLY ESCC, QML OR JAN QUALIFIED ARE DEEMED SUITABLE FOR USE IN AEROSPACE BY THE CORRESPONDING GOVERNMENTAL AGENCY.**

Resale of ST products with provisions different from the statements and/or technical features set forth in this document shall immediately void any warranty granted by ST for the ST product or service described herein and shall not create or extend in any manner whatsoever, any liability of ST.

ST and the ST logo are trademarks or registered trademarks of ST in various countries.

Information in this document supersedes and replaces all information previously supplied.

The ST logo is a registered trademark of STMicroelectronics. All other names are the property of their respective owners.

© 2013 STMicroelectronics - All rights reserved

STMicroelectronics group of companies

Australia - Belgium - Brazil - Canada - China - Czech Republic - Finland - France - Germany - Hong Kong - India - Israel - Italy - Japan - Malaysia - Malta - Morocco - Philippines - Singapore - Spain - Sweden - Switzerland - United Kingdom - United States of America

[www.st.com](http://www.st.com)