

## Schematic for the AR0134CSSM25SUEAH3-GEVB Evaluation Board

### Block Diagram

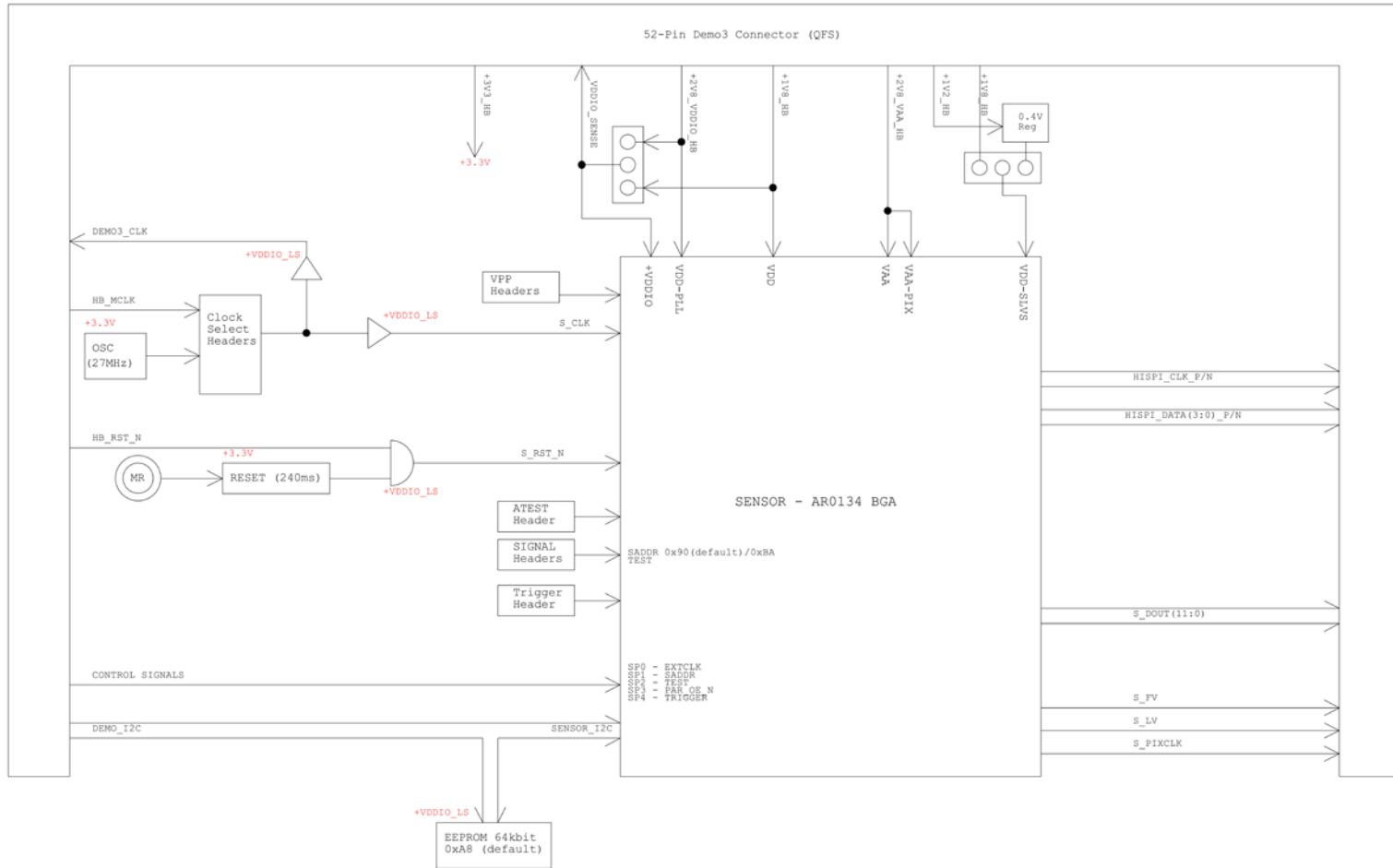



Debug Headers: Cut away the shorted trace and mount header for power debugging

# Power

## VDD 1.8V SUPPLY

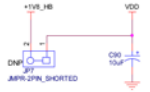

## VDD-SLVS 1.8V SUPPLY

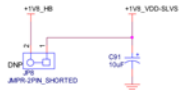

## VDD-PLL 2.8V SUPPLY

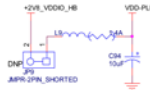

## VAA 2.8V SUPPLY

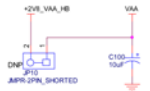

## VAA-PIX 2.8V SUPPLY

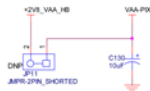

## PERIPHERAL 5V SUPPLY

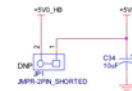

## PERIPHERAL 3.3V SUPPLY

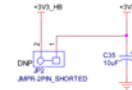

## VDDIO & VDDIO LS 1.8V/2.8V SUPPLY

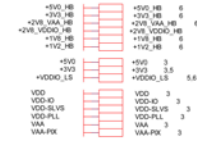
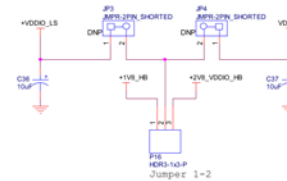

## 5V LED

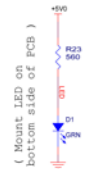

## VDDSLVSPHY 0.4V SUPPLY

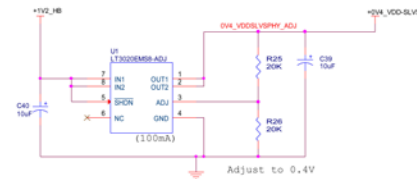

Selection of 0.4V or 1.2V/1V8 for VDDSLVSPHY supply

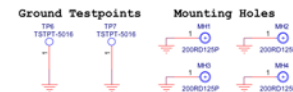
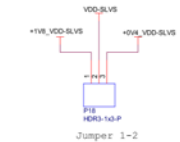

# Clock and Reset

+5V0 3,4  
 +3V0 3,4  
 +VDDIO\_LS 4,6

## CLOCK CIRCUIT

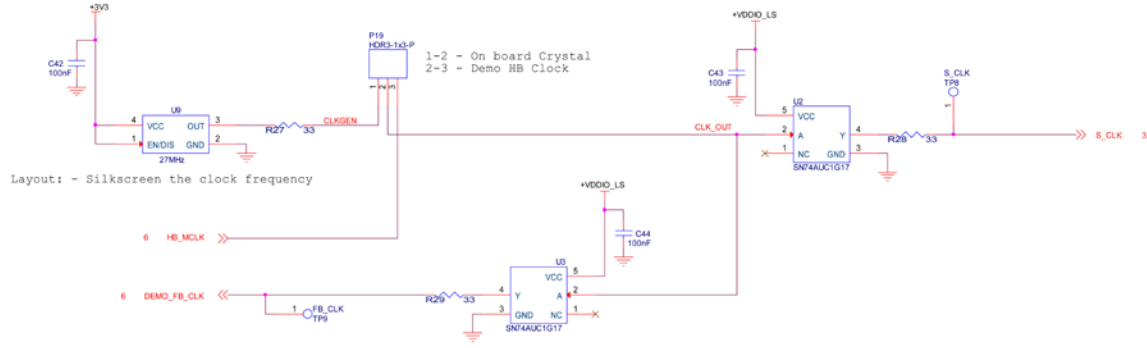

## RESET CIRCUIT

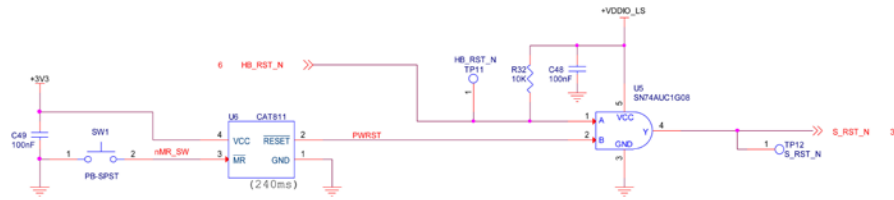



# External Interface

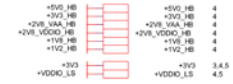

## DEMO3 BASEBOARD I/F

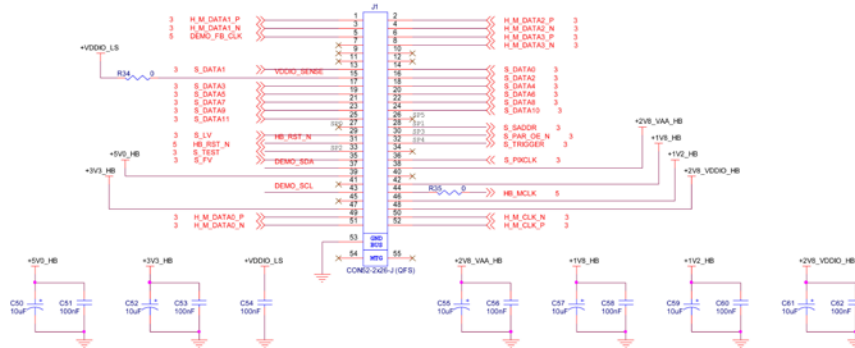

## I2C DEBUG

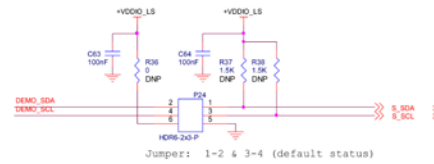

## LENS CORRECTION EEPROM

