

Features

■ High Performance

- f_{MAX} = 260MHz maximum operating frequency
- t_{PD} = 4.4ns propagation delay
- Up to four global clock pins with programmable clock polarity control
- Up to 80 PTs per output

■ Ease of Design

- Flexible CPLD macrocells with individual clock, reset, preset and clock enable controls
- Up to four global OE controls
- Individual local OE control per I/O pin
- Excellent First-Time-Fit™ and refit
- Wide input gating (36 input logic blocks) for fast counters, state machines and address decoders

■ Ultra Low Power

- Standby current as low as 10µA typical
- 1.8V core; low dynamic power
- Operational down to 1.6V V_{CC}
- Superior solution for power sensitive consumer applications
- **Per pin pull-up, pull-down or bus keeper control***
- **Power Guard with multiple enable signals***

■ Broad Device Offering

- 32 to 256 macrocells
- Multiple temperature range support
 - Commercial: 0 to 90°C junction (T_j)
 - Industrial: -40 to 105°C junction (T_j)
- **Space-saving ucBGA and csBGA packages***

■ Easy System Integration

- Operation with 3.3V, 2.5V, 1.8V or 1.5V LVCMOS I/O
- 5V tolerant I/O for LVCMOS 3.3, LVTTTL, and PCI interfaces
- Hot-socketing support
- Open-drain output option
- Programmable output slew rate
- 3.3V PCI compatible
- I/O pins with fast setup path
- **Input hysteresis***
- 1.8V core power supply
- IEEE 1149.1 boundary scan testable
- IEEE 1532 ISC compliant
- 1.8V In-System Programmable (ISP™) using Boundary Scan Test Access Port (TAP)
- Pb-free package options (only)
- **On-chip user oscillator and timer***

*New enhanced features over original ispMACH 4000Z

Table 1. ispMACH 4000ZE Family Selection Guide

	ispMACH 4032ZE	ispMACH 4064ZE	ispMACH 4128ZE	ispMACH 4256ZE
Macrocells	32	64	128	256
t_{PD} (ns)	4.4	4.7	5.8	5.8
t_S (ns)	2.2	2.5	2.9	2.9
t_{CO} (ns)	3.0	3.2	3.8	3.8
f_{MAX} (MHz)	260	241	200	200
Supply Voltages (V)	1.8V	1.8V	1.8V	1.8V
Packages¹ (I/O + Dedicated Inputs)				
48-Pin TQFP (7 x 7mm)	32+4	32+4		
64-Ball csBGA (5 x 5mm)	32+4	48+4		
64-Ball ucBGA (4 x 4mm)		48+4		
100-Pin TQFP (14 x 14mm)		64+10	64+10	64+10
132-Ball ucBGA (6 x 6mm)			96+4	
144-Pin TQFP (20 x 20mm)			96+4	96+14
144-Ball csBGA (7 x 7mm)		64+10	96+4	108+4

1. Pb-free only.

Introduction

The high performance ispMACH 4000ZE family from Lattice offers an ultra low power CPLD solution. The new family is based on Lattice’s industry-leading ispMACH 4000 architecture. Retaining the best of the previous generation, the ispMACH 4000ZE architecture focuses on significant innovations to combine high performance with low power in a flexible CPLD family. For example, the family’s new Power Guard feature minimizes dynamic power consumption by preventing internal logic toggling due to unnecessary I/O pin activity.

The ispMACH 4000ZE combines high speed and low power with the flexibility needed for ease of design. With its robust Global Routing Pool and Output Routing Pool, this family delivers excellent First-Time-Fit, timing predictability, routing, pin-out retention and density migration.

The ispMACH 4000ZE family offers densities ranging from 32 to 256 macrocells. There are multiple density-I/O combinations in Thin Quad Flat Pack (TQFP), Chip Scale BGA (csBGA), and Ultra Chip Scale BGA (ucBGA) packages ranging from 32 to 144 pins/balls. Table 1 shows the macrocell, package and I/O options, along with other key parameters.

A user programmable internal oscillator and a timer are included in the device for tasks like LED control, keyboard scanner and similar housekeeping type state machines. This feature can be optionally disabled to save power.

The ispMACH 4000ZE family has enhanced system integration capabilities. It supports a 1.8V supply voltage and 3.3V, 2.5V, 1.8V and 1.5V interface voltages. Additionally, inputs can be safely driven up to 5.5V when an I/O bank is configured for 3.3V operation, making this family 5V tolerant. The ispMACH 4000ZE also offers enhanced I/O features such as slew rate control, PCI compatibility, bus-keeper latches, pull-up resistors, pull-down resistors, open drain outputs and hot socketing. Pull-up, pull-down and bus-keeper features are controllable on a “per-pin” basis. The ispMACH 4000ZE family members are 1.8V in-system programmable through the IEEE Standard 1532 interface. IEEE Standard 1149.1 boundary scan testing capability also allows product testing on automated test equipment. The 1532 interface signals TCK, TMS, TDI and TDO are referenced to V_{CC} (logic core).

Overview

The ispMACH 4000ZE devices consist of multiple 36-input, 16-macrocell Generic Logic Blocks (GLBs) interconnected by a Global Routing Pool (GRP). Output Routing Pools (ORPs) connect the GLBs to the I/O Blocks (IOBs), which contain multiple I/O cells. This architecture is shown in Figure 1.

Figure 1. Functional Block Diagram



The I/Os in the ispMACH 4000ZE are split into two banks. Each bank has a separate I/O power supply. Inputs can support a variety of standards independent of the chip or bank power supply. Outputs support the standards compatible with the power supply provided to the bank. Support for a variety of standards helps designers implement designs in mixed voltage environments. In addition, 5V tolerant inputs are specified within an I/O bank that is connected to a V_{CCO} of 3.0V to 3.6V for LVCMOS 3.3, LVTTTL and PCI interfaces.

Architecture

There are a total of two GLBs in the ispMACH 4032ZE, increasing to 16 GLBs in the ispMACH 4256ZE. Each GLB has 36 inputs. All GLB inputs come from the GRP and all outputs from the GLB are brought back into the GRP to be connected to the inputs of any other GLB on the device. Even if feedback signals return to the same GLB, they still must go through the GRP. This mechanism ensures that GLBs communicate with each other with consistent and predictable delays. The outputs from the GLB are also sent to the ORP. The ORP then sends them to the associated I/O cells in the I/O block.

Generic Logic Block

The ispMACH 4000ZE GLB consists of a programmable AND array, logic allocator, 16 macrocells and a GLB clock generator. Macrocells are decoupled from the product terms through the logic allocator and the I/O pins are decoupled from macrocells through the ORP. Figure 2 illustrates the GLB.

Figure 2. Generic Logic Block



AND Array

The programmable AND Array consists of 36 inputs and 83 output product terms. The 36 inputs from the GRP are used to form 72 lines in the AND Array (true and complement of the inputs). Each line in the array can be connected to any of the 83 output product terms via a wired-AND. Each of the 80 logic product terms feed the logic allocator with the remaining three control product terms feeding the Shared PT Clock, Shared PT Initialization and Shared PT OE. The Shared PT Clock and Shared PT Initialization signals can optionally be inverted before being fed to the macrocells.

Every set of five product terms from the 80 logic product terms forms a product term cluster starting with PT0. There is one product term cluster for every macrocell in the GLB. Figure 3 is a graphical representation of the AND Array.

Figure 3. AND Array



Enhanced Logic Allocator

Within the logic allocator, product terms are allocated to macrocells in product term clusters. Each product term cluster is associated with a macrocell. The cluster size for the ispMACH 4000ZE family is 4+1 (total 5) product terms. The software automatically considers the availability and distribution of product term clusters as it fits the functions within a GLB. The logic allocator is designed to provide two speed paths: 20-PT Speed Locking path and an up to 80-PT path. The availability of these two paths lets designers trade timing variability for increased performance.

The enhanced Logic Allocator of the ispMACH 4000ZE family consists of the following blocks:

- Product Term Allocator
- Cluster Allocator
- Wide Steering Logic

Figure 4 shows a macrocell slice of the Logic Allocator. There are 16 such slices in the GLB.

Figure 4. Macrocell Slice



Product Term Allocator

The product term allocator assigns product terms from a cluster to either logic or control applications as required by the design being implemented. Product terms that are used as logic are steered into a 5-input OR gate associated with the cluster. Product terms that used for control are steered either to the macrocell or I/O cell associated with the cluster. Table 2 shows the available functions for each of the five product terms in the cluster.

Table 2. Individual PT Steering

Product Term	Logic	Control
PT n	Logic PT	Single PT for XOR/OR
PT $n+1$	Logic PT	Individual Clock (PT Clock)
PT $n+2$	Logic PT	Individual Initialization or Individual Clock Enable (PT Initialization/CE)
PT $n+3$	Logic PT	Individual Initialization (PT Initialization)
PT $n+4$	Logic PT	Individual OE (PTOE)

Cluster Allocator

The cluster allocator allows clusters to be steered to neighboring macrocells, thus allowing the creation of functions with more product terms. Table 3 shows which clusters can be steered to which macrocells. Used in this manner, the cluster allocator can be used to form functions of up to 20 product terms. Additionally, the cluster allocator accepts inputs from the wide steering logic. Using these inputs, functions up to 80 product terms can be created.

Table 3. Available Clusters for Each Macrocell

Macrocell	Available Clusters			
M0	—	C0	C1	C2
M1	C0	C1	C2	C3
M2	C1	C2	C3	C4
M3	C2	C3	C4	C5
M4	C3	C4	C5	C6
M5	C4	C5	C6	C7
M6	C5	C6	C7	C8
M7	C6	C7	C8	C9
M8	C7	C8	C9	C10
M9	C8	C9	C10	C11
M10	C9	C10	C11	C12
M11	C10	C11	C12	C13
M12	C11	C12	C13	C14
M13	C12	C13	C14	C15
M14	C13	C14	C15	—
M15	C14	C15	—	—

Wide Steering Logic

The wide steering logic allows the output of the cluster allocator n to be connected to the input of the cluster allocator $n+4$. Thus, cluster chains can be formed with up to 80 product terms, supporting wide product term functions and allowing performance to be increased through a single GLB implementation. Table 4 shows the product term chains.

Table 4. Product Term Expansion Capability

Expansion Chains	Macrocells Associated with Expansion Chain (with Wrap Around)	Max PT/Macrocell
Chain-0	M0 Õ M4 Õ M8 Õ M12 Õ M0	75
Chain-1	M1 Õ M5 Õ M9 Õ M13 Õ M1	80
Chain-2	M2 Õ M6 Õ M10 Õ M14 Õ M2	75
Chain-3	M3 Õ M7 Õ M11 Õ M15 Õ M3	70

Every time the super cluster allocator is used, there is an incremental delay of t_{EXP} . When the super cluster allocator is used, all destinations other than the one being steered to, are given the value of ground (i.e., if the super cluster is steered to M (n+4), then M (n) is ground).

Macrocell

The 16 macrocells in the GLB are driven by the 16 outputs from the logic allocator. Each macrocell contains a programmable XOR gate, a programmable register/latch, along with routing for the logic and control functions. Figure 5 shows a graphical representation of the macrocell. The macrocells feed the ORP and GRP. A direct input from the I/O cell allows designers to use the macrocell to construct high-speed input registers. A programmable delay in this path allows designers to choose between the fastest possible set-up time and zero hold time.

Figure 5. Macrocell



Enhanced Clock Multiplexer

The clock input to the flip-flop can select any of the four block clocks along with the shared PT clock, and true and complement forms of the optional individual term clock. An 8:1 multiplexer structure is used to select the clock. The eight sources for the clock multiplexer are as follows:

- Block CLK0
- Block CLK1

- Block CLK2
- Block CLK3
- PT Clock
- PT Clock Inverted
- Shared PT Clock
- Ground

Clock Enable Multiplexer

Each macrocell has a 4:1 clock enable multiplexer. This allows the clock enable signal to be selected from the following four sources:

- PT Initialization/CE
- PT Initialization/CE Inverted
- Shared PT Clock
- Logic High

Initialization Control

The ispMACH 4000ZE family architecture accommodates both block-level and macrocell-level set and reset capability. There is one block-level initialization term that is distributed to all macrocell registers in a GLB. At the macrocell level, two product terms can be “stolen” from the cluster associated with a macrocell to be used for set/reset functionality. A reset/preset swapping feature in each macrocell allows for reset and preset to be exchanged, providing flexibility.

Note that the reset/preset swapping selection feature affects power-up reset as well. All flip-flops power up to a known state for predictable system initialization. If a macrocell is configured to SET on a signal from the block-level initialization, then that macrocell will be SET during device power-up. If a macrocell is configured to RESET on a signal from the block-level initialization or is not configured for set/reset, then that macrocell will RESET on power-up. To guarantee initialization values, the V_{CC} rise must be monotonic, and the clock must be inactive until the reset delay time has elapsed.

GLB Clock Generator

Each ispMACH 4000ZE device has up to four clock pins that are also routed to the GRP to be used as inputs. These pins drive a clock generator in each GLB, as shown in Figure 6. The clock generator provides four clock signals that can be used anywhere in the GLB. These four GLB clock signals can consist of a number of combinations of the true and complement edges of the global clock signals.

Figure 6. GLB Clock Generator



Output Routing Pool (ORP)

The Output Routing Pool allows macrocell outputs to be connected to any of several I/O cells within an I/O block. This provides greater flexibility in determining the pinout and allows design changes to occur without affecting the pinout. The output routing pool also provides a parallel capability for routing macrocell-level OE product terms. This allows the OE product term to follow the macrocell output as it is switched between I/O cells. The enhanced ORP of the ispMACH 400ZE family consists of the following elements:

- Output Routing Multiplexers
- OE Routing Multiplexers

Figure 7 shows the structure of the ORP from the I/O cell perspective. This is referred to as an ORP slice. Each ORP has as many ORP slices as there are I/O cells in the corresponding I/O block.

Figure 7. ORP Slice



Output Routing Multiplexers

The details of connections between the macrocells and the I/O cells vary across devices and within a device dependent on the maximum number of I/Os available. Tables 5-7 provide the connection details.

Table 5. GLB/MC/ORP Combinations for ispMACH 4256ZE

GLB/MC	ORP Mux Input Macrocells
[GLB] [MC 0]	M0, M1, M2, M3, M4, M5, M6, M7
[GLB] [MC 1]	M2, M3, M4, M5, M6, M7, M8, M9
[GLB] [MC 2]	M4, M5, M6, M7, M8, M9, M10, M11
[GLB] [MC 3]	M6, M7, M8, M9, M10, M11, M12, M13
[GLB] [MC 4]	M8, M9, M10, M11, M12, M13, M14, M15
[GLB] [MC 5]	M10, M11, M12, M13, M14, M15, M0, M1
[GLB] [MC 6]	M12, M13, M14, M15, M0, M1, M2, M3
[GLB] [MC 7]	M14, M15, M0, M1, M2, M3, M4, M5

Table 6. GLB/MC/ORP Combinations for ispMACH 4128ZE

GLB/MC	ORP Mux Input Macrocells
[GLB] [MC 0]	M0, M1, M2, M3, M4, M5, M6, M7
[GLB] [MC 1]	M1, M2, M3, M4, M5, M6, M7, M8
[GLB] [MC 2]	M2, M3, M4, M5, M6, M7, M8, M9
[GLB] [MC 3]	M4, M5, M6, M7, M8, M9, M10, M11
[GLB] [MC 4]	M5, M6, M7, M8, M9, M10, M11, M12
[GLB] [MC 5]	M6, M7, M8, M9, M10, M11, M12, M13
[GLB] [MC 6]	M8, M9, M10, M11, M12, M13, M14, M15
[GLB] [MC 7]	M9, M10, M11, M12, M13, M14, M15, M0
[GLB] [MC 8]	M10, M11, M12, M13, M14, M15, M0, M1
[GLB] [MC 9]	M12, M13, M14, M15, M0, M1, M2, M3
[GLB] [MC 10]	M13, M14, M15, M0, M1, M2, M3, M4
[GLB] [MC 11]	M14, M15, M0, M1, M2, M3, M4, M5

Table 7. GLB/MC/ORP Combinations for ispMACH 4032ZE and 4064ZE

GLB/MC	ORP Mux Input Macrocells
[GLB] [MC 0]	M0, M1, M2, M3, M4, M5, M6, M7
[GLB] [MC 1]	M1, M2, M3, M4, M5, M6, M7, M8
[GLB] [MC 2]	M2, M3, M4, M5, M6, M7, M8, M9
[GLB] [MC 3]	M3, M4, M5, M6, M7, M8, M9, M10
[GLB] [MC 4]	M4, M5, M6, M7, M8, M9, M10, M11
[GLB] [MC 5]	M5, M6, M7, M8, M9, M10, M11, M12
[GLB] [MC 6]	M6, M7, M8, M9, M10, M11, M12, M13
[GLB] [MC 7]	M7, M8, M9, M10, M11, M12, M13, M14
[GLB] [MC 8]	M8, M9, M10, M11, M12, M13, M14, M15
[GLB] [MC 9]	M9, M10, M11, M12, M13, M14, M15, M0
[GLB] [MC 10]	M10, M11, M12, M13, M14, M15, M0, M1
[GLB] [MC 11]	M11, M12, M13, M14, M15, M0, M1, M2
[GLB] [MC 12]	M12, M13, M14, M15, M0, M1, M2, M3
[GLB] [MC 13]	M13, M14, M15, M0, M1, M2, M3, M4
[GLB] [MC 14]	M14, M15, M0, M1, M2, M3, M4, M5
[GLB] [MC 15]	M15, M0, M1, M2, M3, M4, M5, M6

Output Enable Routing Multiplexers

The OE Routing Pool provides the corresponding local output enable (OE) product term to the I/O cell.

I/O Cell

The I/O cell contains the following programmable elements: output buffer, input buffer, OE multiplexer, Power Guard and bus maintenance circuitry. Figure 8 details the I/O cell.

Figure 8. I/O Cell



Each output supports a variety of output standards dependent on the V_{CCO} supplied to its I/O bank. Outputs can also be configured for open drain operation. Each input can be programmed to support a variety of standards, independent of the V_{CCO} supplied to its I/O bank. The I/O standards supported are:

- LVTTTL
- LVCMOS 3.3
- LVCMOS 2.5
- LVCMOS 1.8
- LVCMOS 1.5
- 3.3V PCI Compatible

All of the I/Os and dedicated inputs have the capability to provide a bus-keeper latch, pull-up resistor or pull-down resistor selectable on a “per-pin” basis. A fourth option is to provide none of these. The default in both hardware and software is such that when the device is erased or if the user does not specify, the input structure is configured to be a Pull-down Resistor.

Each ispMACH 4000ZE device I/O has an individually programmable output slew rate control bit. Each output can be individually configured for fast slew or slow slew. The typical edge rate difference between fast and slow slew setting is 20%. For high-speed designs with long, unterminated traces, the slow-slew rate will introduce fewer reflections, less noise and keep ground bounce to a minimum. For designs with short traces or well terminated lines, the fast slew rate can be used to achieve the highest speed.

The ispMACH 4000ZE family has an always on, 200mV typical hysteresis for each input operational at 3.3V and 2.5V. This provides improved noise immunity for slow transitioning signals.

Power Guard

Power Guard allows easier achievement of standby current in the system. As shown in Figure 9, this feature consists of an enabling multiplexer between an I/O pin and input buffer, and its associated circuitry inside the device.

If the enable signal (E) is held low, all inputs (D) can be optionally isolated (guarded), such that, if any of these were toggled, it would not cause any toggle on internal pins (Q), thus, a toggling I/O pin will not cause any internal dynamic power consumption.

Figure 9. Power Guard



All the I/O pins in a block share a common Power Guard Enable signal. For a block of I/Os, this signal is called a Block Input Enable (BIE) signal. BIE can be internally generated using MC logic, or could come from external sources using one of the user I/O or input pins.

Any I/O pin in the block can be programmed to ignore the BIE signal. Thus, the feature can be enabled or disabled on a pin-by-pin basis.

Figure 10 shows Power Guard and BIE across multiple I/Os in a block that has eight I/Os.

Figure 10. Power Guard and BIE in a Block with 8 I/Os



The number of BIE inputs, thus the number of Power Guard “Blocks” that can exist in a device, depends on the device size. Table 8 shows the number of BIE signals available in the ispMACH 4000ZE family. The number of I/Os available in each block is shown in the Ordering Information section of this data sheet.

Table 8. Number of BIE Signals Available in ispMACH 4000ZE Devices

Device	Number of Logic Blocks, Power Guard Blocks and BIE Signals
ispMACH 4032ZE	Two (Blocks: A and B)
ispMACH 4064ZE	Four (Blocks: A, B, C and D)
ispMACH 4128ZE	Eight (Blocks: A, B, C, ..., H)
ispMACH 4256ZE	Sixteen (Blocks: A, B, C, ..., P)

Power Guard for Dedicated Inputs

Power Guard can optionally be applied to the dedicated inputs. The dedicated inputs and clocks are controlled by the BIE of the logic blocks shown in Tables 9 and 10.

Table 9. Dedicated Clock Inputs to BIE Association

CLK/I	32 MC Block	64MC Block	128MC Block	256MC Block
CLK0 / I	A	A	A	A
CLK1 / I	A	B	D	H
CLK2 / I	B	C	E	I
CLK3 / I	B	D	H	P

Table 10. Dedicated Inputs to BIE Association

Dedicated Input	4064ZE Block	4128ZE Block	4256ZE Block
0	A	B	D
1	B	C	E
2	B	D	G
3	C	F	G
4	D	G	J
5	D	H	L
6	—	—	M
7	—	—	O
8	—	—	O
9	—	—	B

For more information on the Power Guard function refer to TN1174, [Advanced Features of the ispMACH 4000ZE Family](#).

Global OE (GOE) and Block Input Enable (BIE) Generation

Most ispMACH 4000ZE family devices have a 4-bit wide Global OE (GOE) Bus (Figure 11), except the ispMACH 4032 device that has a 2-bit wide Global OE Bus (Figure 12). This bus is derived from a 4-bit internal global OE (GOE) PT bus and two dual purpose I/O or GOE pins. Each signal that drives the bus can optionally be inverted.

Each GLB has a block-level OE PT that connects to all bits of the Global OE PT bus with four fuses. Hence, for a 256-macrocell device (with 16 blocks), each line of the bus is driven from 16 OE product terms. Figures 9 and 10 show a graphical representation of the global OE generation.

The block-level OE PT of each GLB is also tied to Block Input Enable (BIE) of that block. Hence, for a 256-macro-cell device (with 16 blocks), each block's BIE signal is driven by block-level OE PT from each block.

Figure 11. Global OE Generation for All Devices Except ispMACH 4032ZE



Figure 12. Global OE Generation for ispMACH 4032ZE



On-Chip Oscillator and Timer

An internal oscillator is provided for use in miscellaneous housekeeping functions such as watchdog heartbeats, digital de-glitch circuits and control state machines. The oscillator is disabled by default to save power. Figure 13 shows the block diagram of the oscillator and timer block.

Figure 13. On-Chip Oscillator and Timer

Table 11. On-Chip Oscillator and Timer Signal Names

Signal Name	Input or Output	Optional / Required	Description
OSCOUT	Output	Optional	Oscillator Output (Nominal Frequency: 5MHz)
TIMEROUT	Output	Optional	Oscillator Frequency Divided by an integer TIMER_DIV (Default 128)
TIMERRES	Input	Optional	Reset the Timer
DYNOSCDIS	Input	Optional	Disables the Oscillator, resets the Timer and saves the power.

OSCTIMER has two outputs, OSCOUT and TIMEROUT. The outputs feed into the Global Routing Pool (GRP). From GRP, these signals can drive any macrocell input, as well as any output pin (with macrocell bypass). The output OSCOUT is the direct oscillator output with a typical frequency of 5MHz, whereas, the output TIMEROUT is the oscillator output divided by an attribute TIMER_DIV.

The attribute TIMER_DIV can be: 128 (7 bits), 1024 (10 bits) or 1,048,576 (20 bits). The divided output is provided for those user situations, where a very slow clock is desired. If even a slower toggling clock is desired, then the programmable macrocell resources can be used to further divide down the TIMEROUT output.

Figure 14 shows the simplified relationship among OSCOUT, TIMERRES and TIMEROUT. In the diagram, the signal “ \bar{R} ” is an internal reset signal that is used to synchronize TIMERRES to OSCOUT. This adds one extra clock cycle delay for the first timer transition after TIMERRES.

Figure 14. Relationship Among OSCOUT, TIMERRES and TIMEROUT

Note: n = Number of bits in the divider (7, 10 or 20)

Metastability: If the signal TIMERRES is not synchronous to OSCOUT, it could make a difference of one or two clock cycles to the TIMEROUT going high the first time.

Some Simple Use Scenarios

The following diagrams show a few simple examples that omit optional signals for the OSCTIMER block:

- A. An oscillator giving 5MHz nominal clock
- B. An oscillator that can be disabled with an external signal (5MHz nominal clock)
- C. An oscillator giving approximately 5 Hz nominal clock (TIMER_DIV = 2^{20} (1,048,576))
- D. An oscillator giving two output clocks: ~5MHz and ~5KHz (TIMER_DIV = 2^{10} (1,024))



(A) A simple 5MHz oscillator.



(B) An oscillator with dynamic disable.

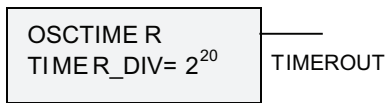

(C) A simple 5Hz oscillator.

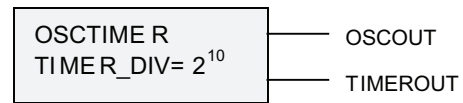

(D) Oscillator with two outputs (5MHz and 5KHz).

OSCTIMER Integration With CPLD Fabric

The OSCTIMER is integrated into the CPLD fabric using the Global Routing Pool (GRP). The macrocell (MC) feedback path for two macrocells is augmented with a programmable multiplexer, as shown in Figure 15. The OSCTIMER outputs (OSCOUT and TIMEROUT) can optionally drive the GRP lines, whereas the macrocell outputs can drive the optional OSCTIMER inputs TIMERRES and DYNOSCDIS.

Figure 15. OSCTIMER Integration With CPLD Fabric

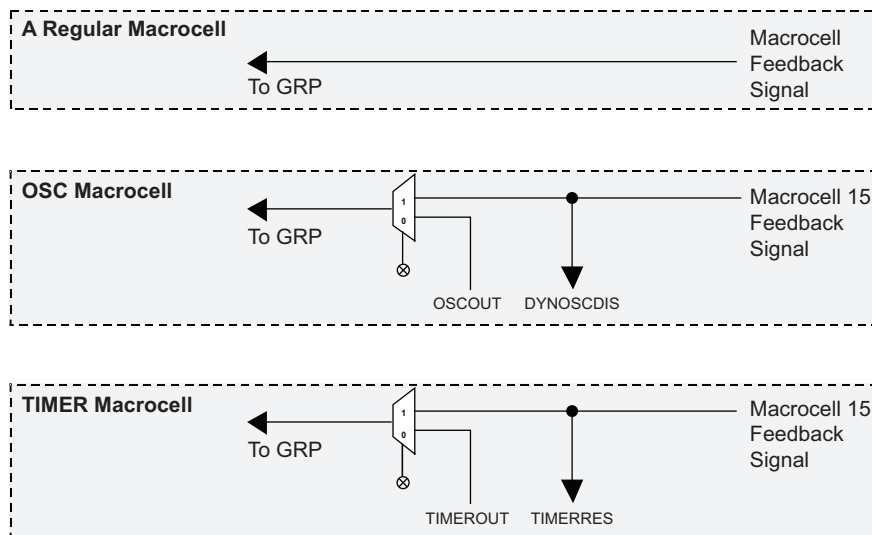

Table 12 shows how these two MCs are designated in each of the ispMACH4000ZE device.

Table 12. OSC and TIMER MC Designation

Device	Macrocell	Block Number	MC Number
ispMACH 4032ZE	OSC MC	A	15
	TIMER MC	B	15
ispMACH 4064ZE	OSC MC	A	15
	TIMER MC	D	15
ispMACH 4128ZE	OSC MC	A	15
	TIMER MC	G	15
ispMACH 4256ZE	OSC MC	C	15
	TIMER MC	F	15

Zero Power/Low Power and Power Management

The ispMACH 4000ZE family is designed with high speed low power design techniques to offer both high speed and low power. With an advanced E² low power cell and non sense-amplifier design approach (full CMOS logic approach), the ispMACH 4000ZE family offers fast pin-to-pin speeds, while simultaneously delivering low standby power without needing any “turbo bits” or other power management schemes associated with a traditional sense-amplifier approach.

The zero power ispMACH 4000ZE is based on the 1.8V ispMACH 4000Z family. With innovative circuit design changes, the ispMACH 4000ZE family is able to achieve the industry’s lowest static power.

IEEE 1149.1-Compliant Boundary Scan Testability

All ispMACH 4000ZE devices have boundary scan cells and are compliant to the IEEE 1149.1 standard. This allows functional testing of the circuit board on which the device is mounted through a serial scan path that can access all critical logic nodes. Internal registers are linked internally, allowing test data to be shifted in and loaded directly onto test nodes, or test node data to be captured and shifted out for verification. In addition, these devices can be linked into a board-level serial scan path for more board-level testing. The test access port operates with an LVCMOS interface that corresponds to the power supply voltage.

I/O Quick Configuration

To facilitate the most efficient board test, the physical nature of the I/O cells must be set before running any continuity tests. As these tests are fast, by nature, the overhead and time that is required for configuration of the I/Os’ physical nature should be minimal so that board test time is minimized. The ispMACH 4000ZE family of devices allows this by offering the user the ability to quickly configure the physical nature of the I/O cells. This quick configuration takes milliseconds to complete, whereas it takes seconds for the entire device to be programmed. Lattice’s ispVM™ System programming software can either perform the quick configuration through the PC parallel port, or can generate the ATE or test vectors necessary for a third-party test system.

IEEE 1532-Compliant In-System Programming

Programming devices in-system provides a number of significant benefits including: rapid prototyping, lower inventory levels, higher quality and the ability to make in-field modifications. All ispMACH 4000ZE devices provide In-System Programming (ISP™) capability through the Boundary Scan Test Access Port. This capability has been implemented in a manner that ensures that the port remains complaint to the IEEE 1149.1 standard. By using IEEE 1149.1 as the communication interface through which ISP is achieved, users get the benefit of a standard, well-defined interface. All ispMACH 4000ZE devices are also compliant with the IEEE 1532 standard.

The ispMACH 4000ZE devices can be programmed across the commercial temperature and voltage range. The PC-based Lattice software facilitates in-system programming of ispMACH 4000ZE devices. The software takes the JEDEC file output produced by the design implementation software, along with information about the scan chain, and creates a set of vectors used to drive the scan chain. The software can use these vectors to drive a scan chain via the parallel port of a PC. Alternatively, the software can output files in formats understood by common auto-

mated test equipment. This equipment can then be used to program ispMACH 4000ZE devices during the testing of a circuit board.

User Electronic Signature

The User Electronic Signature (UES) allows the designer to include identification bits or serial numbers inside the device, stored in E²CMOS memory. The ispMACH 4000ZE device contains 32 UES bits that can be configured by the user to store unique data such as ID codes, revision numbers or inventory control codes.

Security Bit

A programmable security bit is provided on the ispMACH 4000ZE devices as a deterrent to unauthorized copying of the array configuration patterns. Once programmed, this bit defeats readback of the programmed pattern by a device programmer, securing proprietary designs from competitors. Programming and verification are also defeated by the security bit. The bit can only be reset by erasing the entire device.

Hot Socketing

The ispMACH 4000ZE devices are well-suited for applications that require hot socketing capability. Hot socketing a device requires that the device, during power-up and down, can tolerate active signals on the I/Os and inputs without being damaged. Additionally, it requires that the effects of I/O pin loading be minimal on active signals. The ispMACH 4000ZE devices provide this capability for input voltages in the range 0V to 3.0V.

Density Migration

The ispMACH 4000ZE family has been designed to ensure that different density devices in the same package have the same pin-out. Furthermore, the architecture ensures a high success rate when performing design migration from lower density parts to higher density parts. In many cases, it is possible to shift a lower utilization design targeted for a high density device to a lower density device. However, the exact details of the final resource utilization will impact the likely success in each case.

Absolute Maximum Ratings^{1, 2, 3, 4}

Supply Voltage (V_{CC}) -0.5 to 2.5V
 Output Supply Voltage (V_{CCO}) -0.5 to 4.5V
 Input or I/O Tristate Voltage Applied^{5, 6} -0.5 to 5.5V
 Storage Temperature -65 to 150°C
 Junction Temperature (T_j) with Power Applied . . . -55 to 150°C

1. Stress above those listed under the “Absolute Maximum Ratings” may cause permanent damage to the device. Functional operation of the device at these or any other conditions above those indicated in the operational sections of this specification is not implied.
2. Compliance with Lattice [Thermal Management](#) document is required.
3. All voltages referenced to GND.
4. Please refer to the [Lattice ispMACH 4000V/B/C/ZC/ZE Product Family Qualification Summary](#) for complete data, including the ESD performance data.
5. Undershoot of -2V and overshoot of (V_{IH} (MAX) + 2V), up to a total pin voltage of 6V is permitted for a duration of <20ns.
6. Maximum of 64 I/Os per device with $V_{IN} > 3.6V$ is allowed.

Recommended Operating Conditions

Symbol	Parameter	Min.	Max.	Units	
V_{CC}	Supply Voltage	Standard Voltage Operation	1.7	1.9	V
		Extended Voltage Operation	1.6 ¹	1.9	V
T_j	Junction Temperature (Commercial)	0	90	°C	
	Junction Temperature (Industrial)	-40	105	°C	

1. Devices operating at 1.6V can expect performance degradation up to 35%.

Erase Reprogram Specifications

Parameter	Min.	Max.	Units
Erase/Reprogram Cycle	1,000	—	Cycles

Note: Valid over commercial temperature range.

Hot Socketing Characteristics^{1,2,3}

Symbol	Parameter	Condition	Min.	Typ.	Max.	Units
I_{DK}	Input or I/O Leakage Current	$0 \leq V_{IN} \leq 3.0V, T_j = 105^\circ C$	—	±30	±150	µA
		$0 \leq V_{IN} \leq 3.0V, T_j = 130^\circ C$	—	±30	±200	µA

1. Insensitive to sequence of V_{CC} or V_{CCO} . However, assumes monotonic rise/fall rates for V_{CC} and V_{CCO} , provided $(V_{IN} - V_{CCO}) \leq 3.6V$.
2. $0 < V_{CC} < V_{CC} (MAX), 0 < V_{CCO} < V_{CCO} (MAX)$.
3. I_{DK} is additive to I_{PU}, I_{PD} or I_{BH} . Device defaults to pull-up until fuse circuitry is active.

I/O Recommended Operating Conditions

Standard	V _{CCO} (V) ¹	
	Min.	Max.
LVTTTL	3.0	3.6
LVC MOS 3.3	3.0	3.6
Extended LVC MOS 3.3	2.7	3.6
LVC MOS 2.5	2.3	2.7
LVC MOS 1.8	1.65	1.95
LVC MOS 1.5	1.4	1.6
PCI 3.3	3.0	3.6

1. Typical values for V_{CCO} are the average of the min. and max. values.

DC Electrical Characteristics

Over Recommended Operating Conditions

Symbol	Parameter	Condition	Min.	Typ.	Max.	Units
I _{IL} , I _{IH} ^{1,2}	Input Leakage Current	0 ≤ V _{IN} < V _{CCO}	—	0.5	1	μA
I _{IH} ¹	Input High Leakage Current	V _{CCO} < V _{IN} ≤ 5.5V	—	—	10	μA
I _{PU}	I/O Weak Pull-up Resistor Current	0 ≤ V _{IN} ≤ 0.7V _{CCO}	-20	—	-150	μA
I _{PD}	I/O Weak Pull-down Resistor Current	V _{IL} (MAX) ≤ V _{IN} ≤ V _{IH} (MAX)	30	—	150	μA
I _{BHLS}	Bus Hold Low Sustaining Current	V _{IN} = V _{IL} (MAX)	30	—	—	μA
I _{BHHS}	Bus Hold High Sustaining Current	V _{IN} = 0.7 V _{CCO}	-20	—	—	μA
I _{BHLO}	Bus Hold Low Overdrive Current	0V ≤ V _{IN} ≤ V _{BHT}	—	—	150	μA
I _{BHHO}	Bus Hold High Overdrive Current	V _{BHT} ≤ V _{IN} ≤ V _{CCO}	—	—	-150	μA
V _{BHT}	Bus Hold Trip Points	—	V _{CCO} * 0.35	—	V _{CCO} * 0.65	V
C ₁	I/O Capacitance ³	V _{CCO} = 3.3V, 2.5V, 1.8V, 1.5V	—	8	—	pf
		V _{CC} = 1.8V, V _{IO} = 0 to V _{IH} (MAX)	—		—	
C ₂	Clock Capacitance ³	V _{CCO} = 3.3V, 2.5V, 1.8V, 1.5V	—	6	—	pf
		V _{CC} = 1.8V, V _{IO} = 0 to V _{IH} (MAX)	—		—	
C ₃	Global Input Capacitance ³	V _{CCO} = 3.3V, 2.5V, 1.8V, 1.5V	—	6	—	pf
		V _{CC} = 1.8V, V _{IO} = 0 to V _{IH} (MAX)	—		—	

1. Input or I/O leakage current is measured with the pin configured as an input or as an I/O with the output driver tristated. It is not measured with the output driver active. Bus maintenance circuits are disabled.
2. I_{IH} excursions of up to 1.5μA maximum per pin above the spec limit may be observed for certain voltage conditions on no more than 10% of the device's I/O pins.
3. Measured T_A = 25°C, f = 1.0MHz.

Supply Current

To minimize transient current during power-on, configure CPLD I/Os to a pull-up or float state. If this logic scenario is not possible, then the recommended power sequence should assert VCC and VCCO at the same time or VCC before VCCO.

Symbol	Parameter	Condition	Min.	Typ.	Max.	Units
ispMACH 4032ZE						
ICC ^{1, 2, 3, 5, 6}	Operating Power Supply Current	V _{CC} = 1.8V, T _A = 25°C	—	50	—	μA
		V _{CC} = 1.9V, T _A = 0 to 70°C	—	58	—	μA
		V _{CC} = 1.9V, T _A = -40 to 85°C	—	60	—	μA
ICC ^{4, 5, 6}	Standby Power Supply Current	V _{CC} = 1.8V, T _A = 25°C	—	10	—	μA
		V _{CC} = 1.9V, T _A = 0 to 70°C	—	13	25	μA
		V _{CC} = 1.9V, T _A = -40 to 85°C	—	15	40	μA
ispMACH 4064ZE						
ICC ^{1, 2, 3, 5, 6}	Operating Power Supply Current	V _{CC} = 1.8V, T _A = 25°C	—	80	—	μA
		V _{CC} = 1.9V, T _A = 0 to 70°C	—	89	—	μA
		V _{CC} = 1.9V, T _A = -40 to 85°C	—	92	—	μA
ICC ^{4, 5, 6}	Standby Power Supply Current	V _{CC} = 1.8V, T _A = 25°C	—	11	—	μA
		V _{CC} = 1.9V, T _A = 0 to 70°C	—	15	30	μA
		V _{CC} = 1.9V, T _A = -40 to 85°C	—	18	50	μA
ispMACH 4128ZE						
ICC ^{1, 2, 3, 5, 6}	Operating Power Supply Current	V _{CC} = 1.8V, T _A = 25°C	—	168	—	μA
		V _{CC} = 1.9V, T _A = 0 to 70°C	—	190	—	μA
		V _{CC} = 1.9V, T _A = -40 to 85°C	—	195	—	μA
ICC ^{4, 5, 6}	Standby Power Supply Current	V _{CC} = 1.8V, T _A = 25°C	—	12	—	μA
		V _{CC} = 1.9V, T _A = 0 to 70°C	—	16	40	μA
		V _{CC} = 1.9V, T _A = -40 to 85°C	—	19	60	μA
ispMACH 4256ZE						
ICC ^{1, 2, 3, 5, 6}	Operating Power Supply Current	V _{CC} = 1.8V, T _A = 25°C	—	341	—	μA
		V _{CC} = 1.9V, T _A = 0 to 70°C	—	361	—	μA
		V _{CC} = 1.9V, T _A = -40 to 85°C	—	372	—	μA
ICC ^{4, 5, 6}	Standby Power Supply Current	V _{CC} = 1.8V, T _A = 25°C	—	13	—	μA
		V _{CC} = 1.9V, T _A = 0 to 70°C	—	32	65	μA
		V _{CC} = 1.9V, T _A = -40 to 85°C	—	43	100	μA

1. Frequency = 1.0 MHz.
2. Device configured with 16-bit counters.
3. I_{CC} varies with specific device configuration and operating frequency.
4. V_{CCO} = 3.6V, V_{IN} = 0V or V_{CCO}, bus maintenance turned off. V_{IN} above V_{CCO} will add transient current above the specified standby I_{CC}.
5. Includes V_{CCO} current without output loading.
6. This operating supply current is with the internal oscillator disabled. Enabling the internal oscillator adds approximately 15μA typical current plus additional current from any logic it drives.

I/O DC Electrical Characteristics

Over Recommended Operating Conditions

Standard	V_{IL}		V_{IH}		V_{OL} Max (V)	V_{OH} Min (V)	I_{OL}^1 (mA)	I_{OH}^1 (mA)
	Min (V)	Max (V)	Min (V)	Max (V)				
LVTTTL	-0.3	0.80	2.0	5.5	0.40	$V_{CCO} - 0.40$	8.0	-4.0
					0.20	$V_{CCO} - 0.20$	0.1	-0.1
LVCMOS 3.3	-0.3	0.80	2.0	5.5	0.40	$V_{CCO} - 0.40$	8.0	-4.0
					0.20	$V_{CCO} - 0.20$	0.1	-0.1
LVCMOS 2.5	-0.3	0.70	1.70	3.6	0.40	$V_{CCO} - 0.40$	8.0	-4.0
					0.20	$V_{CCO} - 0.20$	0.1	-0.1
LVCMOS 1.8	-0.3	$0.35 * V_{CC}$	$0.65 * V_{CC}$	3.6	0.40	$V_{CCO} - 0.45$	2.0	-2.0
					0.20	$V_{CCO} - 0.20$	0.1	-0.1
LVCMOS 1.5 ²	-0.3	$0.35 * V_{CC}$	$0.65 * V_{CC}$	3.6	0.40	$V_{CCO} - 0.45$	2.0	-2.0
					0.20	$V_{CCO} - 0.20$	0.1	-0.1
PCI 3.3	-0.3	$0.3 * 3.3 * (V_{CC} / 1.8)$	$0.5 * 3.3 * (V_{CC} / 1.8)$	5.5	$0.1 V_{CCO}$	$0.9 V_{CCO}$	1.5	-0.5

- The average DC current drawn by I/Os between adjacent bank GND connections, or between the last GND in an I/O bank and the end of the I/O bank, as shown in the logic signals connection table, shall not exceed $n * 8\text{mA}$. Where n is the number of I/Os between bank GND connections or between the last GND in a bank and the end of a bank.
- For 1.5V inputs, there may be an additional DC current drawn from V_{CC} , if the ispMACH 4000ZE V_{CC} and the V_{CC} of the driving device (V_{CCd-d} ; that determines steady state V_{IH}) are in the extreme range of their specifications. Typically, DC current drawn from V_{CC} will be $2\mu\text{A}$ per input.



ispMACH 400ZE External Switching Characteristics

Over Recommended Operating Conditions

Parameter	Description ^{1,2}	LC4032ZE		LC4064ZE		All Devices				Units
		-4		-4		-5		-7		
		Min.	Max.	Min.	Max.	Min.	Max.	Min.	Max.	
t _{PD}	20-PT combinatorial propagation delay	—	4.4	—	4.7	—	5.8	—	7.5	ns
t _S	GLB register setup time before clock	2.2	—	2.5	—	2.9	—	4.5	—	ns
t _{ST}	GLB register setup time before clock with T-type register	2.4	—	2.7	—	3.1	—	4.7	—	ns
t _{SIR}	GLB register setup time before clock, input register path	1.0	—	1.1	—	1.3	—	1.4	—	ns
t _{SIRZ}	GLB register setup time before clock with zero hold	2.0	—	2.1	—	2.9	—	4.0	—	ns
t _H	GLB register hold time after clock	0.0	—	0.0	—	0.0	—	0.0	—	ns
t _{HT}	GLB register hold time after clock with T-type register	0.0	—	0.0	—	0.0	—	0.0	—	ns
t _{HIR}	GLB register hold time after clock, input register path	1.0	—	1.0	—	1.3	—	1.3	—	ns
t _{HIRZ}	GLB register hold time after clock, input register path with zero hold	0.0	—	0.0	—	0.0	—	0.0	—	ns
t _{CO}	GLB register clock-to-output delay	—	3.0	—	3.2	—	3.8	—	4.5	ns
t _R	External reset pin to output delay	—	5.0	—	6.0	—	7.5	—	9.0	ns
t _{RW}	External reset pulse duration	1.5	—	1.7	—	2.0	—	4.0	—	ns
t _{P_{TOE/DIS}}	Input to output local product term output enable/disable	—	7.0	—	8.0	—	8.2	—	9.0	ns
t _{G_{P_{TOE/DIS}}}	Input to output global product term output enable/disable	—	6.5	—	7.0	—	10.0	—	10.5	ns
t _{GOE/DIS}	Global OE input to output enable/disable	—	4.5	—	4.5	—	5.5	—	7.0	ns
t _{CW}	Global clock width, high or low	1.0	—	1.5	—	1.8	—	2.8	—	ns
t _{GW}	Global gate width low (for low transparent) or high (for high transparent)	1.0	—	1.5	—	1.8	—	2.8	—	ns
t _{WIR}	Input register clock width, high or low	1.0	—	1.5	—	1.8	—	2.8	—	ns
f _{MAX (Int.)} ³	Clock frequency with internal feedback	—	260	—	241	—	200	—	172	MHz
f _{MAX (Ext.)}	clock frequency with external feedback, [1 / (t _S + t _{CO})]	—	192	—	175	—	149	—	111	MHz

1. Timing numbers are based on default LVCMOS 1.8 I/O buffers. Use timing adjusters provided to calculate other standards.

2. Measured using standard switching GRP loading of 1 and 1 output switching.

3. Standard 16-bit counter using GRP feedback.

Timing v.0.8

Timing Model

The task of determining the timing through the ispMACH 4000ZE family, like any CPLD, is relatively simple. The timing model provided in Figure 16 shows the specific delay paths. Once the implementation of a given function is determined either conceptually or from the software report file, the delay path of the function can easily be determined from the timing model. The Lattice design tools report the timing delays based on the same timing model for a particular design. Note that the internal timing parameters are given for reference only, and are not tested. The external timing parameters are tested and guaranteed for every device. For more information on the timing model and usage, refer to TN1168, [ispMACH 4000ZE Timing Model Design and Usage Guidelines](#).

Figure 16. ispMACH 4000ZE Timing Model



Note: Italicized items are optional delay adders.

ispMACH 400ZE Internal Timing Parameters

Over Recommended Operating Conditions

Parameter	Description	LC4032ZE		LC4064ZE		Units
		-4		-4		
		Min.	Max.	Min.	Max.	
In/Out Delays						
t_{IN}	Input Buffer Delay	—	0.85	—	0.90	ns
t_{GCLK_IN}	Global Clock Input Buffer Delay	—	1.60	—	1.60	ns
t_{GOE}	Global OE Pin Delay	—	2.25	—	2.25	ns
t_{BUF}	Delay through Output Buffer	—	0.75	—	0.90	ns
t_{EN}	Output Enable Time	—	2.25	—	2.25	ns
t_{DIS}	Output Disable Time	—	1.35	—	1.35	ns
t_{PGSU}	Input Power Guard Setup Time	—	3.30	—	3.55	ns
t_{PGH}	Input Power Guard Hold Time	—	0.00	—	0.00	ns
t_{PGPW}	Input Power Guard BIE Minimum Pulse Width	—	5.00	—	5.00	ns
t_{PGRT}	Input Power Guard Recovery Time Following BIE Dissertation	—	5.00	—	5.00	ns
Routing Delays						
t_{ROUTE}	Delay through GRP	—	1.60	—	1.70	ns
t_{PDI}	Macrocell Propagation Delay	—	0.25	—	0.25	ns
t_{MCELL}	Macrocell Delay	—	0.65	—	0.65	ns
t_{INREG}	Input Buffer to Macrocell Register Delay	—	0.90	—	1.00	ns
t_{FBK}	Internal Feedback Delay	—	0.55	—	0.55	ns
t_{ORP}	Output Routing Pool Delay	—	0.30	—	0.30	ns
Register/Latch Delays						
t_S	D-Register Setup Time (Global Clock)	0.70	—	0.85	—	ns
t_{S_PT}	D-Register Setup Time (Product Term Clock)	1.25	—	1.85	—	ns
t_H	D-Register Hold Time	1.50	—	1.65	—	ns
t_{ST}	T-Register Setup Time (Global Clock)	0.90	—	1.05	—	ns
t_{ST_PT}	T-register Setup Time (Product Term Clock)	1.45	—	1.65	—	ns
t_{HT}	T-Resister Hold Time	1.50	—	1.65	—	ns
t_{SIR}	D-Input Register Setup Time (Global Clock)	0.85	—	0.80	—	ns
t_{SIR_PT}	D-Input Register Setup Time (Product Term Clock)	1.45	—	1.45	—	ns
t_{HIR}	D-Input Register Hold Time (Global Clock)	1.15	—	1.30	—	ns
t_{HIR_PT}	D-Input Register Hold Time (Product Term Clock)	0.90	—	1.10	—	ns
t_{COi}	Register Clock to Output/Feedback MUX Time	—	0.35	—	0.40	ns
t_{CES}	Clock Enable Setup Time	1.00	—	2.00	—	ns
t_{CEH}	Clock Enable Hold Time	0.00	—	0.00	—	ns
t_{SL}	Latch Setup Time (Global Clock)	0.70	—	0.95	—	ns
t_{SL_PT}	Latch Setup Time (Product Term Clock)	1.45	—	1.85	—	ns
t_{HL}	Latch Hold Time	1.40	—	1.80	—	ns
t_{GOi}	Latch Gate to Output/Feedback MUX Time	—	0.40	—	0.35	ns
t_{PDLi}	Propagation Delay through Transparent Latch to Output/Feedback MUX	—	0.30	—	0.25	ns
t_{SRI}	Asynchronous Reset or Set to Output/Feedback MUX Delay	—	0.30	—	0.30	ns

ispMACH 400ZE Internal Timing Parameters (Cont.)

Over Recommended Operating Conditions

Parameter	Description	LC4032ZE		LC4064ZE		Units	
		-4		-4			
		Min.	Max.	Min.	Max.		
t _{SRR}	Asynchronous Reset or Set Recovery Delay	—	2.00	—	1.70	ns	
Control Delays							
t _{BCLK}	GLB PT Clock Delay	—	1.20	—	1.30	ns	
t _{PTCLK}	Macrocell PT Clock Delay	—	1.40	—	1.50	ns	
t _{BSR}	Block PT Set/Reset Delay	—	1.10	—	1.85	ns	
t _{PTSR}	Macrocell PT Set/Reset Delay	—	1.20	—	1.90	ns	
t _{BIE}	Power Guard Block Input Enable Delay	—	1.60	—	1.70	ns	
t _{P_{TOE}}	Macrocell PT OE Delay	—	2.30	—	3.15	ns	
t _{GPTOE}	Global PT OE Delay	—	1.80	—	2.15	ns	
Internal Oscillator							
t _{OSCSU}	Oscillator DYNOSCDIS Setup Time	5.00	—	5.00	—	ns	
t _{OSCH}	Oscillator DYNOSCDIS Hold Time	5.00	—	5.00	—	ns	
t _{OSCEN}	Oscillator OSCOUT Enable Time (To Stable)	—	5.00	—	5.00	ns	
t _{OSCOD}	Oscillator Output Delay	—	4.00	—	4.00	ns	
t _{OSCNOM}	Oscillator OSCOUT Nominal Frequency	—	5.00	—	5.00	MHz	
t _{OSCvar}	Oscillator Variation of Nominal Frequency	—	30	—	30	%	
t _{TMRCO20}	Oscillator TIMEROUT Clock (Negative Edge) to Out (20-Bit Divider)	—	12.50	—	12.50	ns	
t _{TMRCO10}	Oscillator TIMEROUT Clock (Negative Edge) to Out (10-Bit Divider)	—	7.50	—	7.50	ns	
t _{TMRCO7}	Oscillator TIMEROUT Clock (Negative Edge) to Out (7-Bit Divider)	—	6.00	—	6.00	ns	
t _{TMRRSTO}	Oscillator TIMEROUT Reset to Out (Going Low)	—	5.00	—	5.00	ns	
t _{TMRRR}	Oscillator TIMEROUT Asynchronous Reset Recovery Delay	—	4.00	—	4.00	ns	
t _{TMRRSTPW}	Oscillator TIMEROUT Reset Minimum Pulse Width	3.00	—	3.00	—	ns	
Optional Delay Adjusters		Base Parameter					
t _{INDIO}	Input Register Delay	t _{INREG}	—	1.00	—	1.00	ns
t _{EXP}	Product Term Expander Delay	t _{MCELL}	—	0.40	—	0.40	ns
t _{BLA}	Additional Block Loading Adders	t _{ROUTE}	—	0.04	—	0.05	ns
t_{IOI} Input Buffer Delays							
LVTTL_in	Using LVTTTL Standard with Hysteresis	t _{IN} , t _{GCLK_IN} , t _{GOE}	—	0.60	—	0.60	ns
LVC MOS15_in	Using LVC MOS 1.5 Standard	t _{IN} , t _{GCLK_IN} , t _{GOE}	—	0.20	—	0.20	ns
LVC MOS18_in	Using LVC MOS 1.8 Standard	t _{IN} , t _{GCLK_IN} , t _{GOE}	—	0.00	—	0.00	ns
LVC MOS25_in	Using LVC MOS 2.5 Standard with Hysteresis	t _{IN} , t _{GCLK_IN} , t _{GOE}	—	0.80	—	0.80	ns
LVC MOS33_in	Using LVC MOS 3.3 Standard with Hysteresis	t _{IN} , t _{GCLK_IN} , t _{GOE}	—	0.80	—	0.80	ns
PCI_in	Using PCI Compatible Input with Hysteresis	t _{IN} , t _{GCLK_IN} , t _{GOE}	—	0.80	—	0.80	ns
t_{IOO} Output Buffer Delays							
LVTTL_out	Output Configured as TTL Buffer	t _{EN} , t _{DIS} , t _{BUF}	—	0.20	—	0.20	ns

ispMACH 400ZE Internal Timing Parameters (Cont.)

Over Recommended Operating Conditions

Parameter	Description		LC4032ZE		LC4064ZE		Units
			-4		-4		
			Min.	Max.	Min.	Max.	
LVC MOS15_out	Output Configured as 1.5V Buffer	t_{EN} , t_{DIS} , t_{BUF}	—	0.20	—	0.20	ns
LVC MOS18_out	Output Configured as 1.8V Buffer	t_{EN} , t_{DIS} , t_{BUF}	—	0.00	—	0.00	ns
LVC MOS25_out	Output Configured as 2.5V Buffer	t_{EN} , t_{DIS} , t_{BUF}	—	0.10	—	0.10	ns
LVC MOS33_out	Output Configured as 3.3V Buffer	t_{EN} , t_{DIS} , t_{BUF}	—	0.20	—	0.20	ns
PCI_out	Output Configured as PCI Compatible Buffer	t_{EN} , t_{DIS} , t_{BUF}	—	0.20	—	0.20	ns
Slow Slew	Output Configured for Slow Slew Rate	t_{EN} , t_{BUF}	—	1.00	—	1.00	ns

Note: Internal Timing Parameters are not tested and are for reference only. Refer to the timing model in this data sheet for further details.
 Timing v.0.8

ispMACH 400ZE Internal Timing Parameters (Cont.)

Over Recommended Operating Conditions

Parameter	Description	All Devices				Units
		-5		-7		
		Min.	Max.	Min.	Max.	
In/Out Delays						
t_{IN}	Input Buffer Delay	—	1.05	—	1.90	ns
t_{GCLK_IN}	Global Clock Input Buffer Delay	—	1.95	—	2.15	ns
t_{GOE}	Global OE Pin Delay	—	3.00	—	4.30	ns
t_{BUF}	Delay through Output Buffer	—	1.10	—	1.30	ns
t_{EN}	Output Enable Time	—	2.50	—	2.70	ns
t_{DIS}	Output Disable Time	—	2.50	—	2.70	ns
t_{PGSU}	Input Power Guard Setup Time	—	4.30	—	5.60	ns
t_{PGH}	Input Power Guard Hold Time	—	0.00	—	0.00	ns
t_{PGPW}	Input Power Guard BIE Minimum Pulse Width	—	6.00	—	8.00	ns
t_{PGRT}	Input Power Guard Recovery Time Following BIE Dis- sertation	—	5.00	—	7.00	ns
Routing Delays						
t_{ROUTE}	Delay through GRP	—	2.25	—	2.50	ns
t_{PDi}	Macrocell Propagation Delay	—	0.45	—	0.50	ns
t_{MCELL}	Macrocell Delay	—	0.65	—	1.00	ns
t_{INREG}	Input Buffer to Macrocell Register Delay	—	1.00	—	1.00	ns
t_{FBK}	Internal Feedback Delay	—	0.75	—	0.30	ns
t_{ORP}	Output Routing Pool Delay	—	0.30	—	0.30	ns
Register/Latch Delays						
t_S	D-Register Setup Time (Global Clock)	0.90	—	1.25	—	ns
t_{S_PT}	D-Register Setup Time (Product Term Clock)	2.00	—	2.35	—	ns
t_H	D-Register Hold Time	2.00	—	3.25	—	ns
t_{ST}	T-Register Setup Time (Global Clock)	1.10	—	1.45	—	ns
t_{ST_PT}	T-register Setup Time (Product Term Clock)	2.20	—	2.65	—	ns
t_{HT}	T-Resister Hold Time	2.00	—	3.25	—	ns
t_{SIR}	D-Input Register Setup Time (Global Clock)	1.20	—	0.65	—	ns
t_{SIR_PT}	D-Input Register Setup Time (Product Term Clock)	1.45	—	1.45	—	ns
t_{HIR}	D-Input Register Hold Time (Global Clock)	1.40	—	2.05	—	ns
t_{HIR_PT}	D-Input Register Hold Time (Product Term Clock)	1.10	—	1.20	—	ns
t_{COi}	Register Clock to Output/Feedback MUX Time	—	0.45	—	0.75	ns
t_{CES}	Clock Enable Setup Time	2.00	—	2.00	—	ns
t_{CEH}	Clock Enable Hold Time	0.00	—	0.00	—	ns
t_{SL}	Latch Setup Time (Global Clock)	0.90	—	1.55	—	ns
t_{SL_PT}	Latch Setup Time (Product Term Clock)	2.00	—	2.05	—	ns
t_{HL}	Latch Hold Time	2.00	—	1.17	—	ns
t_{GOi}	Latch Gate to Output/Feedback MUX Time	—	0.35	—	0.33	ns
t_{PDLi}	Propagation Delay through Transparent Latch to Output/ Feedback MUX	—	0.25	—	0.25	ns
t_{SRi}	Asynchronous Reset or Set to Output/Feedback MUX Delay	—	0.95	—	0.28	ns

ispMACH 400ZE Internal Timing Parameters (Cont.)

Over Recommended Operating Conditions

Parameter	Description	All Devices				Units	
		-5		-7			
		Min.	Max.	Min.	Max.		
t _{SRR}	Asynchronous Reset or Set Recovery Delay	—	1.80	—	1.67	ns	
Control Delays							
t _{BCLK}	GLB PT Clock Delay	—	1.45	—	0.95	ns	
t _{PTCLK}	Macrocell PT Clock Delay	—	1.45	—	1.15	ns	
t _{BSR}	Block PT Set/Reset Delay	—	1.85	—	1.83	ns	
t _{PTSR}	Macrocell PT Set/Reset Delay	—	1.85	—	2.72	ns	
t _{BIE}	Power Guard Block Input Enable Delay	—	1.75	—	1.95	ns	
t _{P_{TOE}}	Macrocell PT OE Delay	—	2.40	—	1.90	ns	
t _{GPTOE}	Global PT OE Delay	—	4.20	—	3.40	ns	
Internal Oscillator							
t _{OSCSU}	Oscillator DYNOSCDIS Setup Time	5.00	—	5.00	—	ns	
t _{OSCH}	Oscillator DYNOSCDIS Hold Time	5.00	—	5.00	—	ns	
t _{OSCEN}	Oscillator OSCOUT Enable Time (To Stable)	—	5.00	—	5.00	ns	
t _{OSCOD}	Oscillator Output Delay	—	4.00	—	4.00	ns	
t _{OSCNOM}	Oscillator OSCOUT Nominal Frequency	—	5.00	—	5.00	MHz	
t _{OSCvar}	Oscillator Variation of Nominal Frequency	—	30	—	30	%	
t _{TMRCO20}	Oscillator TIMEROUT Clock (Negative Edge) to Out (20-Bit Divider)	—	12.50	—	14.50	ns	
t _{TMRCO10}	Oscillator TIMEROUT Clock (Negative Edge) to Out (10-Bit Divider)	—	7.50	—	9.50	ns	
t _{TMRCO7}	Oscillator TIMEROUT Clock (Negative Edge) to Out (7-Bit Divider)	—	6.00	—	8.00	ns	
t _{TMRRSTO}	Oscillator TIMEROUT Reset to Out (Going Low)	—	5.00	—	7.00	ns	
t _{TMRRR}	Oscillator TIMEROUT Asynchronous Reset Recovery Delay	—	4.00	—	6.00	ns	
t _{TMRRSTPW}	Oscillator TIMEROUT Reset Minimum Pulse Width	3.00	—	5.00	—	ns	
Optional Delay Adjusters		Base Parameter					
t _{INDIO}	Input Register Delay	t _{INREG}	—	1.60	—	2.60	ns
t _{EXP}	Product Term Expander Delay	t _{MCELL}	—	0.45	—	0.50	ns
t _{BLA}	Additional Block Loading Adders	t _{ROUTE}	—	0.05	—	0.05	ns
t_{IOI} Input Buffer Delays							
LVTTL_in	Using LVTTL Standard with Hysteresis	t _{IN} , t _{GCLK_IN} , t _{GOE}	—	0.60	—	0.60	ns
LVC MOS15_in	Using LVC MOS 1.5 Standard	t _{IN} , t _{GCLK_IN} , t _{GOE}	—	0.20	—	0.20	ns
LVC MOS18_in	Using LVC MOS 1.8 Standard	t _{IN} , t _{GCLK_IN} , t _{GOE}	—	0.00	—	0.00	ns
LVC MOS25_in	Using LVC MOS 2.5 Standard with Hysteresis	t _{IN} , t _{GCLK_IN} , t _{GOE}	—	0.80	—	0.80	ns
LVC MOS33_in	Using LVC MOS 3.3 Standard with Hysteresis	t _{IN} , t _{GCLK_IN} , t _{GOE}	—	0.80	—	0.80	ns
PCI_in	Using PCI Compatible Input with Hysteresis	t _{IN} , t _{GCLK_IN} , t _{GOE}	—	0.80	—	0.80	ns
t_{IOO} Output Buffer Delays							
LVTTL_out	Output Configured as TTL Buffer	t _{EN} , t _{DIS} , t _{BUF}	—	0.20	—	0.20	ns

ispMACH 4000ZE Internal Timing Parameters (Cont.)

Over Recommended Operating Conditions

Parameter	Description	All Devices				Units	
		-5		-7			
		Min.	Max.	Min.	Max.		
LVC MOS15_out	Output Configured as 1.5V Buffer	t_{EN} , t_{DIS} , t_{BUF}	—	0.20	—	0.20	ns
LVC MOS18_out	Output Configured as 1.8V Buffer	t_{EN} , t_{DIS} , t_{BUF}	—	0.00	—	0.00	ns
LVC MOS25_out	Output Configured as 2.5V Buffer	t_{EN} , t_{DIS} , t_{BUF}	—	0.10	—	0.10	ns
LVC MOS33_out	Output Configured as 3.3V Buffer	t_{EN} , t_{DIS} , t_{BUF}	—	0.20	—	0.20	ns
PCI_out	Output Configured as PCI Compatible Buffer	t_{EN} , t_{DIS} , t_{BUF}	—	0.20	—	0.20	ns
Slow Slew	Output Configured for Slow Slew Rate	t_{EN} , t_{BUF}	—	1.00	—	1.00	ns

Note: Internal Timing Parameters are not tested and are for reference only. Refer to the timing model in this data sheet for further details.
 Timing v.0.8

Boundary Scan Waveforms and Timing Specifications

Symbol	Parameter	Min.	Max.	Units
t _{BTCP}	TCK [BSCAN test] clock cycle	40	—	ns
t _{BTCH}	TCK [BSCAN test] pulse width high	20	—	ns
t _{BTCL}	TCK [BSCAN test] pulse width low	20	—	ns
t _{BTSU}	TCK [BSCAN test] setup time	8	—	ns
t _{BTH}	TCK [BSCAN test] hold time	10	—	ns
t _{BRF}	TCK [BSCAN test] rise and fall time	50	—	mV/ns
t _{BTCO}	TAP controller falling edge of clock to valid output	—	10	ns
t _{BTOZ}	TAP controller falling edge of clock to data output disable	—	10	ns
t _{BTVO}	TAP controller falling edge of clock to data output enable	—	10	ns
t _{BTCPsu}	BSCAN test Capture register setup time	8	—	ns
t _{BTCPH}	BSCAN test Capture register hold time	10	—	ns
t _{BTUCO}	BSCAN test Update reg, falling edge of clock to valid output	—	25	ns
t _{BTUOZ}	BSCAN test Update reg, falling edge of clock to output disable	—	25	ns
t _{BTUOV}	BSCAN test Update reg, falling edge of clock to output enable	—	25	ns

Power Consumption



Power Estimation Coefficients¹

Device	A	B
ispMACH 4032ZE	0.010	0.009
ispMACH 4064ZE	0.011	0.009
ispMACH 4128ZE	0.012	0.009
ispMACH 4256ZE	0.013	0.009

1. For further information about the use of these coefficients, refer to TN1187, [Power Estimation in ispMACH 4000ZE Devices](#).

Switching Test Conditions

Figure 17 shows the output test load that is used for AC testing. The specific values for resistance, capacitance, voltage, and other test conditions are shown in Table 13.

Figure 17. Output Test Load, LVTTTL and LVCMOS Standards



0213A/ispm4k

Table 13. Test Fixture Required Components

Test Condition	R ₁	R ₂	C _L ¹	Timing Ref.	V _{CCO}
LVCMOS I/O, (L -> H, H -> L)	106Ω	106Ω	35pF	LVCMOS 3.3 = 1.5V	LVCMOS 3.3 = 3.0V
				LVCMOS 2.5 = $\frac{V_{CCO}}{2}$	LVCMOS 2.5 = 2.3V
				LVCMOS 1.8 = $\frac{V_{CCO}}{2}$	LVCMOS 1.8 = 1.65V
				LVCMOS 1.5 = $\frac{V_{CCO}}{2}$	LVCMOS 1.5 = 1.4V
LVCMOS I/O (Z -> H)	∞	106Ω	35pF	1.5V	3.0V
LVCMOS I/O (Z -> L)	106Ω	∞	35pF	1.5V	3.0V
LVCMOS I/O (H -> Z)	∞	106Ω	5pF	V _{OH} - 0.3	3.0V
LVCMOS I/O (L -> Z)	106Ω	∞	5pF	V _{OL} + 0.3	3.0V

1. C_L includes test fixtures and probe capacitance.

Signal Descriptions

Signal Names	Description	
TMS	Input – This pin is the IEEE 1149.1 Test Mode Select input, which is used to control the state machine.	
TCK	Input – This pin is the IEEE 1149.1 Test Clock input pin, used to clock through the state machine.	
TDI	Input – This pin is the IEEE 1149.1 Test Data In pin, used to load data.	
TDO	Output – This pin is the IEEE 1149.1 Test Data Out pin used to shift data out.	
GOE0/IO, GOE1/IO	These pins are configured to be either Global Output Enable Input or as general I/O pins.	
GND	Ground	
NC	Not Connected	
V _{CC}	The power supply pins for logic core and JTAG port.	
CLK0/I, CLK1/I, CLK2/I, CLK3/I	These pins are configured to be either CLK input or as an input.	
V _{CC00} , V _{CC01}	The power supply pins for each I/O bank.	
yzz	Input/Output ¹ – These are the general purpose I/O used by the logic array. y is GLB reference (alpha) and z is macrocell reference (numeric). z: 0-15.	
	ispMACH 4032ZE	y: A-B
	ispMACH 4064ZE	y: A-D
	ispMACH 4128ZE	y: A-H
	ispMACH 4256ZE	y: A-P

1. In some packages, certain I/Os are only available for use as inputs. See the Logic Signal Connections tables for details.

ORP Reference Table

	4032ZE	4064ZE			4128ZE		4256ZE		
Number of I/Os	32	32	48	64	64	96	64	96	108
Number of GLBs	2	4	4	4	8	8	16	16	16
Number of I/Os per GLB	16	8	Mixture of 9, 10, 14, 15	16	8	12	4	6	Mixture of 6, 7, 8
Reference ORP Table (I/Os per GLB)	16	8	9, 10, 14, 15	16	8	12	4	6	6, 7, 8

ispMACH 4000ZE Power Supply and NC Connections¹

Signal	48 TQFP ²	64 csBGA ^{3,4}	64 ucBGA ^{3,4}	100 TQFP ²
VCC	12, 36	E4, D5	E4, D5	25, 40, 75, 90
VCCO0 VCCO (Bank 0)	6	4032ZE: E3 4064ZE: E3, F4	C3, F3	13, 33, 95
VCCO1 VCCO (Bank 1)	30	4032ZE: D6 4064ZE: D6, C6	F6, A6	45, 63, 83
GND	13, 37	D4, E5	D4, D5	1, 26, 51, 76
GND (Bank 0)	5	D4, E5	D4, D5	7, 18, 32, 96
GND (Bank 1)	29	D4, E5	D4, D5	46, 57, 68, 82
NC	—	—	—	—

1. All grounds must be electrically connected at the board level. However, for the purposes of I/O current loading, grounds are associated with the bank shown.
2. Pin orientation follows the conventional order from pin 1 marking of the top side view and counter-clockwise.
3. Pin orientation A1 starts from the upper left corner of the top side view with alphabetical order ascending vertically and numerical order ascending horizontally.
4. All bonded grounds are connected to the following two balls, D4 and E5.

ispMACH 4000ZE Power Supply and NC Connections¹ (Cont.)

Signal	132 ucBGA ³	144 csBGA ³	144 TQFP ²
VCC	M1, M7, A12, B5	H5, H8, E8, E5	36, 57, 108, 129
VCCO0 VCCO (Bank 0)	B1, H4, L2, J5, A4	E4, F4, G4, J5, D5	3, 19, 34, 47, 136
VCCO1 VCCO (Bank 1)	K9, L12, F12, D9, C7	J8, H9, G9, F9, D8	64, 75, 91, 106, 119
GND	E5, E8, H5, H8	F6, G6, G7, F7	1, 37, 73, 109
GND (Bank 0)	E2, H2, M4, B7, B3	G5, H4, H6, E6, F5	10, 18 ⁴ , 27, 46, 127, 137
GND (Bank 1)	L7, J9, H12, E9, A9	H7, J9, G8, F8, E7	55, 65, 82, 90 ⁴ , 99, 118
NC	—	4064ZE: E4, B2, B1, D2, D3, E1, H1, H3, H2, L1, G4, M1, K3, M2, M4, L5, H7, L8, M8, L10, K9, M11, H9, L12, L11, J12, J11, H10, D10, F10, D12, B12, F9, A12, C10, B10, A9, B8, E6, B5, A5, C4, B3, A2 4128ZE: D2, D3, H2, M1, K3, M11, J12, J11, D12, A12, C10, A2	4128ZE: 17, 20, 38, 45, 72, 89, 92, 110, 117, 144 4256ZE: 18, 90

1. All grounds must be electrically connected at the board level. However, for the purposes of I/O current loading, grounds are associated with the bank shown.
2. Pin orientation follows the conventional order from pin 1 marking of the top side view and counter-clockwise.
3. Pin orientation A1 starts from the upper left corner of the top side view with alphabetical order ascending vertically and numerical order ascending horizontally.
4. For the LC4256ZE, pins 18 and 90 are no connects.

ispMACH 4032ZE and 4064ZE Logic Signal Connections: 48 TQFP

Pin Number	Bank Number	ispMACH 4032ZE	ispMACH 4064ZE
		GLB/MC/Pad	GLB/MC/Pad
1	-	TDI	TDI
2	0	A5	A8
3	0	A6	A10
4	0	A7	A11
5	0	GND (Bank 0)	GND (Bank 0)
6	0	VCCO (Bank 0)	VCCO (Bank 0)
7	0	A8	B15
8	0	A9	B12
9	0	A10	B10
10	0	A11	B8
11	-	TCK	TCK
12	-	VCC	VCC
13	-	GND	GND
14	0	A12	B6
15	0	A13	B4
16	0	A14	B2
17	0	A15	B0
18	0	CLK1/I	CLK1/I
19	1	CLK2/I	CLK2/I
20	1	B0	C0
21	1	B1	C1
22	1	B2	C2
23	1	B3	C4
24	1	B4	C6
25	-	TMS	TMS
26	1	B5	C8
27	1	B6	C10
28	1	B7	C11
29	1	GND (Bank 1)	GND (Bank 1)
30	1	VCCO (Bank 1)	VCCO (Bank 1)
31	1	B8	D15
32	1	B9	D12
33	1	B10	D10
34	1	B11	D8
35	-	TDO	TDO
36	-	VCC	VCC
37	-	GND	GND
38	1	B12	D6
39	1	B13	D4
40	1	B14	D2
41	1	B15/GOE1	D0/GOE1
42	1	CLK3/I	CLK3/I

ispMACH 4032ZE and 4064ZE Logic Signal Connections: 48 TQFP (Cont.)

Pin Number	Bank Number	ispMACH 4032ZE	ispMACH 4064ZE
		GLB/MC/Pad	GLB/MC/Pad
43	0	CLK0/I	CLK0/I
44	0	A0/GOE0	A0/GOE0
45	0	A1	A1
46	0	A2	A2
47	0	A3	A4
48	0	A4	A6

ispMACH 4032ZE and 4064ZE Logic Signal Connections: 64 csBGA

Ball Number	Bank Number	ispMACH 4032ZE	ispMACH 4064ZE
		GLB/MC/Pad	GLB/MC/Pad
B2	-	TDI	TDI
B1	0	A5	A8
C2	0	A6	A10
C1	0	A7	A11
GND*	0	GND (Bank 0)	GND (Bank 0)
C3	0	NC	A12
E3	0	VCCO (Bank 0)	VCCO (Bank 0)
D1	0	A8	B15
D2	0	NC	B14
E1	0	A9	B13
D3	0	A10	B12
F1	0	A11	B11
E2	0	NC	B10
G1	0	NC	B9
F2	0	NC	B8
H1	-	TCK	TCK
E4	-	VCC	VCC
GND*	-	GND	GND
G2	0	A12	B6
H2	0	NC	B5
H3	0	A13	B4
GND*	0	NC	GND (Bank 0)
F4	0	NC	VCCO (Bank 0)
G3	0	A14	B3
F3	0	NC	B2
H4	0	A15	B0
G4	0	CLK1/I	CLK1/I
H5	1	CLK2/I	CLK2/I
F5	1	B0	C0
G5	1	B1	C1
G6	1	B2	C2
H6	1	B3	C4
F6	1	B4	C5
H7	1	NC	C6
H8	-	TMS	TMS
G7	1	B5	C8
F7	1	B6	C10
G8	1	B7	C11
GND*	1	GND (Bank 0)	GND (Bank 1)
F8	1	NC	C12
D6	1	VCCO (Bank 1)	VCCO (Bank 1)
E8	1	B8	D15

ispMACH 4032ZE and 4064ZE Logic Signal Connections: 64 csBGA (Cont.)

Ball Number	Bank Number	ispMACH 4032ZE	ispMACH 4064ZE
		GLB/MC/Pad	GLB/MC/Pad
E7	1	NC	D14
E6	1	B9	D13
D7	1	B10	D12
D8	1	NC	D11
C5	1	NC	D10
C7	1	B11	D9
C8	1	NC	D8
B8	-	TDO	TDO
D5	-	VCC	VCC
GND*	-	GND	GND
A8	1	B12	D7
A7	1	NC	D6
B7	1	NC	D5
A6	1	B13	D4
GND*	1	NC	GND (Bank 1)
C6	1	NC	VCCO (Bank 1)
B6	1	B14	D3
A5	1	NC	D2
B5	1	B15/GOE1	D0/GOE1
A4	1	CLK3/I	CLK3/I
C4	0	CLK0/I	CLK0/I
B4	0	A0/GOE0	A0/GOE0
B3	0	A1	A1
A3	0	A2	A2
A2	0	A3	A4
A1	0	A4	A6

* All bonded grounds are connected to the following two balls, D4 and E5.

ispMACH 4064ZE Logic Signal Connections: 64 ucBGA

Ball Number	Bank Number	GLB/MC/Pad
A1	-	TDI
B1	0	A8
B2	0	A10
B3	0	A11
GND*	0	GND (Bank 0)
C1	0	A12
C3	0	VCCO (Bank 0)
C2	0	B15
D1	0	B14
D2	0	B13
D3	0	B12
E1	0	B11
E2	0	B10
E3	0	B9
F1	0	B8
F2	-	TCK
E4	-	VCC
GND*	-	GND
H2	0	B6
H1	0	B5
G1	0	B4
GND*	0	GND (Bank 0)
F3	0	VCCO (Bank 0)
G2	0	B3
G3	0	B2
H3	0	B0
G4	0	CLK1/I
F4	1	CLK2/I
H4	1	C0
H5	1	C1
G5	1	C2
H6	1	C4
H7	1	C5
H8	1	C6
G8	-	TMS
G7	1	C8
G6	1	C10
F8	1	C11
GND*	1	GND (Bank 1)
F7	1	C12
F6	1	VCCO (Bank 1)
F5	1	D15
E8	1	D14

ispMACH 4064ZE Logic Signal Connections: 64 ucBGA (Cont.)

Ball Number	Bank Number	GLB/MC/Pad
E7	1	D13
E6	1	D12
D8	1	D11
D7	1	D10
D6	1	D9
C8	1	D8
C7	-	TDO
D5	-	VCC
GND*	-	GND
B8	1	D7
A8	1	D6
B7	1	D5
A7	1	D4
GND*	1	GND (Bank 1)
A6	1	VCCO (Bank 1)
B6	1	D3
C6	1	D2
A5	1	D0/GOE1
B5	1	CLK3/I
C5	0	CLK0/I
A4	0	A0/GOE0
B4	0	A1
C4	0	A2
A3	0	A4
A2	0	A6

* All bonded grounds are connected to the following two balls, D4 and E5.

**ispMACH 4064ZE, 4128ZE and 4256ZE Logic Signal Connections:
100 TQFP**

Pin Number	Bank Number	LC4064ZE	LC4128ZE	LC4256ZE
		GLB/MC/Pad	GLB/MC/Pad	GLB/MC/Pad
1	-	GND	GND	GND
2	-	TDI	TDI	TDI
3	0	A8	B0	C12
4	0	A9	B2	C10
5	0	A10	B4	C6
6	0	A11	B6	C2
7	0	GND (Bank 0)	GND (Bank 0)	GND (Bank 0)
8	0	A12	B8	D12
9	0	A13	B10	D10
10	0	A14	B12	D6
11	0	A15	B13	D4
12*	0	I	I	I
13	0	VCCO (Bank 0)	VCCO (Bank 0)	VCCO (Bank 0)
14	0	B15	C14	E4
15	0	B14	C12	E6
16	0	B13	C10	E10
17	0	B12	C8	E12
18	0	GND (Bank 0)	GND (Bank 0)	GND (Bank 0)
19	0	B11	C6	F2
20	0	B10	C5	F6
21	0	B9	C4	F10
22	0	B8	C2	F12
23*	0	I	I	I
24	-	TCK	TCK	TCK
25	-	VCC	VCC	VCC
26	-	GND	GND	GND
27*	0	I	I	I
28	0	B7	D13	G12
29	0	B6	D12	G10
30	0	B5	D10	G6
31	0	B4	D8	G2
32	0	GND (Bank 0)	GND (Bank 0)	GND (Bank 0)
33	0	VCCO (Bank 0)	VCCO (Bank 0)	VCCO (Bank 0)
34	0	B3	D6	H12
35	0	B2	D4	H10
36	0	B1	D2	H6
37	0	B0	D0	H2
38	0	CLK1/I	CLK1/I	CLK1/I
39	1	CLK2/I	CLK2/I	CLK2/I
40	-	VCC	VCC	VCC
41	1	C0	E0	I2

**ispMACH 4064ZE, 4128ZE and 4256ZE Logic Signal Connections:
100 TQFP (Cont.)**

Pin Number	Bank Number	LC4064ZE	LC4128ZE	LC4256ZE
		GLB/MC/Pad	GLB/MC/Pad	GLB/MC/Pad
42	1	C1	E2	I6
43	1	C2	E4	I10
44	1	C3	E6	I12
45	1	VCCO (Bank 1)	VCCO (Bank 1)	VCCO (Bank 1)
46	1	GND (Bank 1)	GND (Bank 1)	GND (Bank 1)
47	1	C4	E8	J2
48	1	C5	E10	J6
49	1	C6	E12	J10
50	1	C7	E14	J12
51	-	GND	GND	GND
52	-	TMS	TMS	TMS
53	1	C8	F0	K12
54	1	C9	F2	K10
55	1	C10	F4	K6
56	1	C11	F6	K2
57	1	GND (Bank 1)	GND (Bank 1)	GND (Bank 1)
58	1	C12	F8	L12
59	1	C13	F10	L10
60	1	C14	F12	L6
61	1	C15	F13	L4
62*	1	I	I	I
63	1	VCCO (Bank 1)	VCCO (Bank 1)	VCCO (Bank 1)
64	1	D15	G14	M4
65	1	D14	G12	M6
66	1	D13	G10	M10
67	1	D12	G8	M12
68	1	GND (Bank 1)	GND (Bank 1)	GND (Bank 1)
69	1	D11	G6	N2
70	1	D10	G5	N6
71	1	D9	G4	N10
72	1	D8	G2	N12
73*	1	I	I	I
74	-	TDO	TDO	TDO
75	-	VCC	VCC	VCC
76	-	GND	GND	GND
77*	1	I	I	I
78	1	D7	H13	O12
79	1	D6	H12	O10
80	1	D5	H10	O6
81	1	D4	H8	O2
82	1	GND (Bank 1)	GND (Bank 1)	GND (Bank 1)

**ispMACH 4064ZE, 4128ZE and 4256ZE Logic Signal Connections:
100 TQFP (Cont.)**

Pin Number	Bank Number	LC4064ZE	LC4128ZE	LC4256ZE
		GLB/MC/Pad	GLB/MC/Pad	GLB/MC/Pad
83	1	VCCO (Bank 1)	VCCO (Bank 1)	VCCO (Bank 1)
84	1	D3	H6	P12
85	1	D2	H4	P10
86	1	D1	H2	P6
87	1	D0/GOE1	H0/GOE1	P2/GOE1
88	1	CLK3/I	CLK3/I	CLK3/I
89	0	CLK0/I	CLK0/I	CLK0/I
90	-	VCC	VCC	VCC
91	0	A0/GOE0	A0/GOE0	A2/GOE0
92	0	A1	A2	A6
93	0	A2	A4	A10
94	0	A3	A6	A12
95	0	VCCO (Bank 0)	VCCO (Bank 0)	VCCO (Bank 0)
96	0	GND (Bank 0)	GND (Bank 0)	GND (Bank 0)
97	0	A4	A8	B2
98	0	A5	A10	B6
99	0	A6	A12	B10
100	0	A7	A14	B12

* This pin is input only.

ispMACH 4128ZE Logic Signal Connections: 132 ucBGA

Ball Number	Bank Number	GLB/MC/Pad
GND*	-	GND
A1	-	TDI
B1	0	VCCO (Bank 0)
D3	0	B0
C1	0	B1
D2	0	B2
D1	0	B4
E4	0	B5
F3	0	B6
E2	0	GND (Bank 0)
E1	0	B8
E3	0	B9
F4	0	B10
G4	0	B12
F2	0	B13
G3	0	B14
H4	0	VCCO (Bank 0)
F1	0	C14
G2	0	C13
G1	0	C12
H3	0	C10
J4	0	C9
H1	0	C8
H2	0	GND (Bank 0)
J3	0	C6
J1	0	C5
J2	0	C4
K3	0	C2
K2	0	C1
K1	0	C0
L2	0	VCCO (Bank 0)
L1	-	TCK
M1	-	VCC
GND*	-	GND
L3	0	D14
M2	0	D13
K4	0	D12
M3	0	D10
K5	0	D9
L4	0	D8
M4	0	GND (Bank 0)
J5	0	VCCO (Bank 0)
L5	0	D6

ispMACH 4128ZE Logic Signal Connections: 132 ucBGA (Cont.)

Ball Number	Bank Number	GLB/MC/Pad
M5	0	D5
J6	0	D4
K6	0	D2
L6	0	D1
M6	0	D0
K7	0	CLK1/I
L7	1	GND (Bank 1)
J7	1	CLK2/I
M7	-	VCC
K8	1	E0
L8	1	E1
M8	1	E2
J8	1	E4
L9	1	E5
M9	1	E6
K9	1	VCCO (Bank 1)
J9	1	GND (Bank 1)
L10	1	E8
K10	1	E9
M10	1	E10
L11	1	E12
K12	1	E13
M11	1	E14
GND*	-	GND
M12	-	TMS
L12	1	VCCO (Bank 1)
K11	1	F0
J10	1	F1
H9	1	F2
J12	1	F4
J11	1	F5
H10	1	F6
H12	1	GND (Bank 1)
G9	1	F8
H11	1	F9
F9	1	F10
G12	1	F12
G11	1	F13
G10	1	F14
F12	1	VCCO (Bank 1)
F10	1	G14
F11	1	G13
E11	1	G12
E10	1	G10

ispMACH 4128ZE Logic Signal Connections: 132 ucBGA (Cont.)

Ball Number	Bank Number	GLB/MC/Pad
D10	1	G9
E12	1	G8
E9	1	GND (Bank 1)
D12	1	G6
D11	1	G5
C12	1	G4
C10	1	G2
C11	1	G1
B11	1	G0
D9	1	VCCO (Bank 1)
B12	-	TDO
A12	-	VCC
GND*	-	GND
A10	1	H14
A11	1	H13
B10	1	H12
C9	1	H10
D8	1	H9
C8	1	H8
A9	1	GND (Bank 1)
C7	1	VCCO (Bank 1)
B9	1	H6
B8	1	H5
D7	1	H4
A8	1	H2
A7	1	H1
B6	1	H0/GOE1
C6	1	CLK3/I
B7	0	GND (Bank 0)
D6	0	CLK0/I
B5	-	VCC
A6	0	A0/GOE0
C5	0	A1
B4	0	A2
A5	0	A4
C4	0	A5
D5	0	A6
A4	0	VCCO (Bank 0)
B3	0	GND (Bank 0)
D4	0	A8
A3	0	A9
C3	0	A10
B2	0	A12
C2	0	A13

ispMACH 4128ZE Logic Signal Connections: 132 ucBGA (Cont.)

Ball Number	Bank Number	GLB/MC/Pad
A2	0	A14

* All bonded core grounds are connected to the following four balls, E5, E8, H5 and H8.

**ispMACH 4064ZE, 4128ZE and 4256ZE Logic Signal Connections:
144 csBGA**

Ball Number	Bank Number	LC4064ZE	LC4128ZE	LC4256ZE
		GLB/MC/Pad	GLB/MC/Pad	GLB/MC/Pad
F6	-	GND	GND	GND
A1	-	TDI	TDI	TDI
E4	0	NC Ball	VCCO (Bank 0)	VCCO (Bank 0)
B2	0	NC Ball	B0	C12
B1	0	NC Ball	B1	C10
C3	0	A8	B2	C8
C2	0	A9	B4	C6
C1	0	A10	B5	C4
D1	0	A11	B6	C2
G5	0	GND (Bank 0)	GND (Bank 0)	GND (Bank 0)
D2	0	NC Ball	NC Ball	D14
D3	0	NC Ball	NC Ball	D12
E1	0	NC Ball	B8	D10
E2	0	A12	B9	D8
F2	0	A13	B10	D6
D4	0	A14	B12	D4
F1	0	A15	B13	D2
F3*	0	I	B14	D0
F4	0	VCCO (Bank 0)	VCCO (Bank 0)	VCCO (Bank 0)
G1	0	B15	C14	E0
E3	0	B14	C13	E2
G2	0	B13	C12	E4
G3	0	B12	C10	E6
H1	0	NC Ball	C9	E8
H3	0	NC Ball	C8	E10
H2	0	NC Ball	NC Ball	E12
H4	0	GND (Bank 0)	GND (Bank 0)	GND (Bank 0)
J1	0	B11	C6	F2
J3	0	B10	C5	F4
J2	0	B9	C4	F6
K1	0	B8	C2	F8
K2*	0	I	C1	F10
L1	0	NC Ball	C0	F12
G4	0	NC Ball	VCCO (Bank 0)	VCCO (Bank 0)
L2	-	TCK	TCK	TCK
H5	-	VCC	VCC	VCC
G6	-	GND	GND	GND
M1	0	NC Ball	NC Ball	G14
K3	0	NC Ball	NC Ball	G12
M2	0	NC Ball	D14	G10
L3*	0	I	D13	G8

**ispMACH 4064ZE, 4128ZE and 4256ZE Logic Signal Connections:
 144 csBGA (Cont.)**

Ball Number	Bank Number	LC4064ZE	LC4128ZE	LC4256ZE
		GLB/MC/Pad	GLB/MC/Pad	GLB/MC/Pad
J4	0	B7	D12	G6
K4	0	B6	D10	G4
M3	0	B5	D9	G2
L4	0	B4	D8	G0
H6	0	GND (Bank 0)	GND (Bank 0)	GND (Bank 0)
J5	0	VCCO (Bank 0)	VCCO (Bank 0)	VCCO (Bank 0)
M4	0	NC Ball	D6	H12
L5	0	NC Ball	D5	H10
K5	0	B3	D4	H8
J6	0	B2	D2	H6
M5	0	B1	D1	H4
K6	0	B0	D0	H2
L6	0	CLK1/I	CLK1/I	CLK1/I
H7	1	NC Ball	GND (Bank 1)	GND (Bank 1)
M6	1	CLK2/I	CLK2/I	CLK2/I
H8	-	VCC	VCC	VCC
K7	1	C0	E0	I2
M7	1	C1	E1	I4
L7	1	C2	E2	I6
J7	1	C3	E4	I8
L8	1	NC Ball	E5	I10
M8	1	NC Ball	E6	I12
J8	1	VCCO (Bank 1)	VCCO (Bank 1)	VCCO (Bank 1)
J9	1	GND (Bank 1)	GND (Bank 1)	GND (Bank 1)
M9	1	C4	E8	J2
L9	1	C5	E9	J4
K8	1	C6	E10	J6
M10	1	C7	E12	J8
L10	1	NC Ball	E13	J10
K9	1	NC Ball	E14	J12
M11	1	NC Ball	NC Ball	J14
G7	-	GND	GND	GND
M12	-	TMS	TMS	TMS
H9	1	NC Ball	VCCO (Bank 1)	VCCO (Bank 1)
L12	1	NC Ball	F0	K12
L11	1	NC Ball	F1	K10
K10	1	C8	F2	K8
K12	1	C9	F4	K6
J10	1	C10	F5	K4
K11	1	C11	F6	K2
G8	1	GND (Bank 1)	GND (Bank 1)	GND (Bank 1)

**ispMACH 4064ZE, 4128ZE and 4256ZE Logic Signal Connections:
144 csBGA (Cont.)**

Ball Number	Bank Number	LC4064ZE	LC4128ZE	LC4256ZE
		GLB/MC/Pad	GLB/MC/Pad	GLB/MC/Pad
J12	1	NC Ball	NC Ball	L14
J11	1	NC Ball	NC Ball	L12
H10	1	NC Ball	F8	L10
H12	1	C12	F9	L8
G11	1	C13	F10	L6
H11	1	C14	F12	L4
G12	1	C15	F13	L2
G10*	1	I	F14	L0
G9	1	VCCO (Bank 1)	VCCO (Bank 1)	VCCO (Bank 1)
F12	1	D15	G14	M0
F11	1	D14	G13	M2
E11	1	D13	G12	M4
E12	1	D12	G10	M6
D10	1	NC Ball	G9	M8
F10	1	NC Ball	G8	M10
D12	1	NC Ball	NC Ball	M12
F8	1	GND (Bank 1)	GND (Bank 1)	GND (Bank 1)
E10	1	D11	G6	N2
D11	1	D10	G5	N4
E9	1	D9	G4	N6
C12	1	D8	G2	N8
C11*	1	I	G1	N10
B12	1	NC Ball	G0	N12
F9	1	NC Ball	VCCO (Bank 1)	VCCO (Bank 1)
B11	-	TDO	TDO	TDO
E8	-	VCC	VCC	VCC
F7	-	GND	GND	GND
A12	1	NC Ball	NC Ball	O14
C10	1	NC Ball	NC Ball	O12
B10	1	NC Ball	H14	O10
A11*	1	I	H13	O8
D9	1	D7	H12	O6
B9	1	D6	H10	O4
C9	1	D5	H9	O2
A10	1	D4	H8	O0
E7	1	GND (Bank 1)	GND (Bank 1)	GND (Bank 1)
D8	1	VCCO (Bank 1)	VCCO (Bank 1)	VCCO (Bank 1)
A9	1	NC Ball	H6	P12
B8	1	NC Ball	H5	P10
C8	1	D3	H4	P8
A8	1	D2	H2	P6
D7	1	D1	H1	P4
B7	1	D0/GOE1	H0/GOE1	P2/GOE1

**ispMACH 4064ZE, 4128ZE and 4256ZE Logic Signal Connections:
144 csBGA (Cont.)**

Ball Number	Bank Number	LC4064ZE	LC4128ZE	LC4256ZE
		GLB/MC/Pad	GLB/MC/Pad	GLB/MC/Pad
C7	1	CLK3/I	CLK3/I	CLK3/I
E6	0	NC Ball	GND (Bank 0)	GND (Bank 0)
A7	0	CLK0/I	CLK0/I	CLK0/I
E5	-	VCC	VCC	VCC
D6	0	A0/GOE0	A0/GOE0	A2/GOE0
B6	0	A1	A1	A4
A6	0	A2	A2	A6
C6	0	A3	A4	A8
B5	0	NC Ball	A5	A10
A5	0	NC Ball	A6	A12
D5	0	VCCO (Bank 0)	VCCO (Bank 0)	VCCO (Bank 0)
F5	0	GND (Bank 0)	GND (Bank 0)	GND (Bank 0)
A4	0	A4	A8	B2
B4	0	A5	A9	B4
C5	0	A6	A10	B6
A3	0	A7	A12	B8
C4	0	NC Ball	A13	B10
B3	0	NC Ball	A14	B12
A2	0	NC Ball	NC Ball	B14

* This pin is input only for the LC4064ZE.

ispMACH 4128ZE and 4256ZE Logic Signal Connections: 144 TQFP

Pin Number	Bank Number	LC4128ZE	LC4256ZE
		GLB/MC/Pad	GLB/MC/Pad
1	-	GND	GND
2	-	TDI	TDI
3	0	VCCO (Bank 0)	VCCO (Bank 0)
4	0	B0	C12
5	0	B1	C10
6	0	B2	C8
7	0	B4	C6
8	0	B5	C4
9	0	B6	C2
10	0	GND (Bank 0)	GND (Bank 0)
11	0	B8	D14
12	0	B9	D12
13	0	B10	D10
14	0	B12	D8
15	0	B13	D6
16	0	B14	D4
17*	0	NC	I
18	0	GND (Bank 0)	NC
19	0	VCCO (Bank 0)	VCCO (Bank 0)
20*	0	NC	I
21	0	C14	E2
22	0	C13	E4
23	0	C12	E6
24	0	C10	E8
25	0	C9	E10
26	0	C8	E12
27	0	GND (Bank 0)	GND (Bank 0)
28	0	C6	F2
29	0	C5	F4
30	0	C4	F6
31	0	C2	F8
32	0	C1	F10
33	0	C0	F12
34	0	VCCO (Bank 0)	VCCO (Bank 0)
35	-	TCK	TCK
36	-	VCC	VCC
37	-	GND	GND
38*	0	NC	I
39	0	D14	G12
40	0	D13	G10
41	0	D12	G8
42	0	D10	G6

ispMACH 4128ZE and 4256ZE Logic Signal Connections: 144 TQFP (Cont.)

Pin Number	Bank Number	LC4128ZE	LC4256ZE
		GLB/MC/Pad	GLB/MC/Pad
43	0	D9	G4
44	0	D8	G2
45*	0	NC	I
46	0	GND (Bank 0)	GND (Bank 0)
47	0	VCCO (Bank 0)	VCCO (Bank 0)
48	0	D6	H12
49	0	D5	H10
50	0	D4	H8
51	0	D2	H6
52	0	D1	H4
53	0	D0	H2
54	0	CLK1/I	CLK1/I
55	1	GND (Bank 1)	GND (Bank 1)
56	1	CLK2/I	CLK2/I
57	-	VCC	VCC
58	1	E0	I2
59	1	E1	I4
60	1	E2	I6
61	1	E4	I8
62	1	E5	I10
63	1	E6	I12
64	1	VCCO (Bank 1)	VCCO (Bank 1)
65	1	GND (Bank 1)	GND (Bank 1)
66	1	E8	J2
67	1	E9	J4
68	1	E10	J6
69	1	E12	J8
70	1	E13	J10
71	1	E14	J12
72*	1	NC	I
73	-	GND	GND
74	-	TMS	TMS
75	1	VCCO (Bank 1)	VCCO (Bank 1)
76	1	F0	K12
77	1	F1	K10
78	1	F2	K8
79	1	F4	K6
80	1	F5	K4
81	1	F6	K2
82	1	GND (Bank 1)	GND (Bank 1)
83	1	F8	L14
84	1	F9	L12
85	1	F10	L10

ispMACH 4128ZE and 4256ZE Logic Signal Connections: 144 TQFP (Cont.)

Pin Number	Bank Number	LC4128ZE	LC4256ZE
		GLB/MC/Pad	GLB/MC/Pad
86	1	F12	L8
87	1	F13	L6
88	1	F14	L4
89*	1	NC	I
90	1	GND (Bank 1)	NC
91	1	VCCO (Bank 1)	VCCO (Bank 1)
92*	1	NC	I
93	1	G14	M2
94	1	G13	M4
95	1	G12	M6
96	1	G10	M8
97	1	G9	M10
98	1	G8	M12
99	1	GND (Bank 1)	GND (Bank 1)
100	1	G6	N2
101	1	G5	N4
102	1	G4	N6
103	1	G2	N8
104	1	G1	N10
105	1	G0	N12
106	1	VCCO (Bank 1)	VCCO (Bank 1)
107	-	TDO	TDO
108	-	VCC	VCC
109	-	GND	GND
110*	1	NC	I
111	1	H14	O12
112	1	H13	O10
113	1	H12	O8
114	1	H10	O6
115	1	H9	O4
116	1	H8	O2
117*	1	NC	I
118	1	GND (Bank 1)	GND (Bank 1)
119	1	VCCO (Bank 1)	VCCO (Bank 1)
120	1	H6	P12
121	1	H5	P10
122	1	H4	P8
123	1	H2	P6
124	1	H1	P4
125	1	H0/GOE1	P2/GOE1
126	1	CLK3/I	CLK3/I
127	0	GND (Bank 0)	GND (Bank 0)
128	0	CLK0/I	CLK0/I

ispMACH 4128ZE and 4256ZE Logic Signal Connections: 144 TQFP (Cont.)

Pin Number	Bank Number	LC4128ZE	LC4256ZE
		GLB/MC/Pad	GLB/MC/Pad
129	-	VCC	VCC
130	0	A0/GOE0	A2/GOE0
131	0	A1	A4
132	0	A2	A6
133	0	A4	A8
134	0	A5	A10
135	0	A6	A12
136	0	VCCO (Bank 0)	VCCO (Bank 0)
137	0	GND (Bank 0)	GND (Bank 0)
138	0	A8	B2
139	0	A9	B4
140	0	A10	B6
141	0	A12	B8
142	0	A13	B10
143	0	A14	B12
144*	0	NC	I

* This pin is input only for the LC4256ZE.

Part Number Description

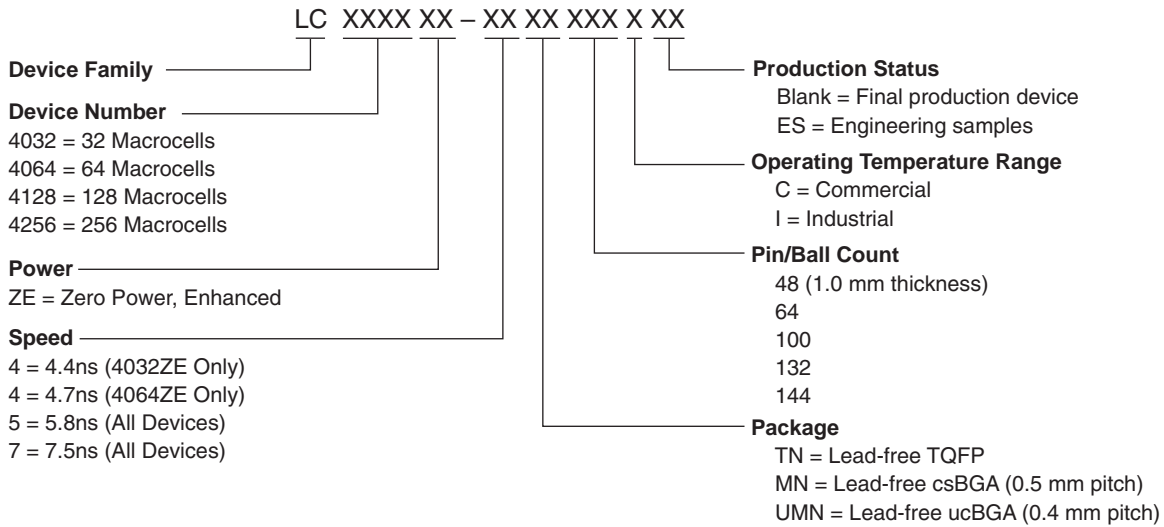

ispMACH 400ZE Family Speed Grade Offering

	-4	-5		-7	
	Commercial	Commercial	Industrial	Commercial	Industrial
ispMACH 4032ZE	✓	✓	✓	✓	✓
ispMACH 4064ZE	✓	✓	✓	✓	✓
ispMACH 4128ZE		✓		✓	✓
ispMACH 4256ZE		✓		✓	✓

Ordering Information

Note: ispMACH 400ZE devices are dual marked except for the slowest commercial speed grade. For example, the commercial speed grade LC4128ZE-5TN100C is also marked with the industrial grade -7I. The commercial grade is always one speed grade faster than the associated dual mark industrial grade. The slowest commercial speed grade devices are marked as commercial grade only. The markings appear as follows:

Figure 18. Mark Format for 100 TQFP and 144 TQFP Packages

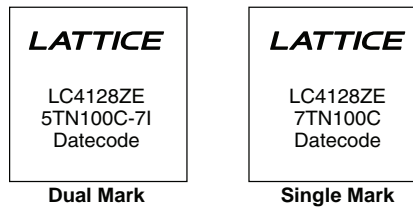

Figure 19. Mark Format for 48 TQFP, 64 csBGA and 144 csBGA Packages

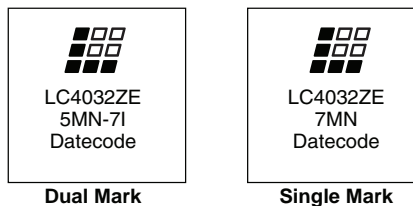
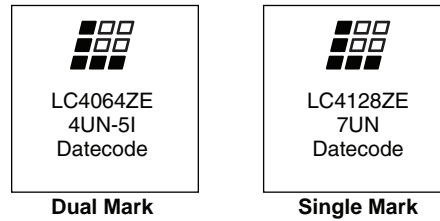

Figure 20. Mark Format for 64 ucBGA and 132 ucBGA Packages

Lead-Free Packaging
Commercial

Device	Part Number	Macrocells	Voltage	t _{PD}	Package	Pin/Ball Count	I/O	Grade
LC4032ZE	LC4032ZE-4TN48C	32	1.8	4.4	Lead-Free TQFP	48	32	C
	LC4032ZE-5TN48C	32	1.8	5.8	Lead-Free TQFP	48	32	C
	LC4032ZE-7TN48C	32	1.8	7.5	Lead-Free TQFP	48	32	C
	LC4032ZE-4MN64C	32	1.8	4.4	Lead-Free csBGA	64	32	C
	LC4032ZE-5MN64C	32	1.8	5.8	Lead-Free csBGA	64	32	C
	LC4032ZE-7MN64C	32	1.8	7.5	Lead-Free csBGA	64	32	C
LC4064ZE	LC4064ZE-4TN48C	64	1.8	4.7	Lead-Free TQFP	48	32	C
	LC4064ZE-5TN48C	64	1.8	5.8	Lead-Free TQFP	48	32	C
	LC4064ZE-7TN48C	64	1.8	7.5	Lead-Free TQFP	48	32	C
	LC4064ZE-4TN100C	64	1.8	4.7	Lead-Free TQFP	100	64	C
	LC4064ZE-5TN100C	64	1.8	5.8	Lead-Free TQFP	100	64	C
	LC4064ZE-7TN100C	64	1.8	7.5	Lead-Free TQFP	100	64	C
	LC4064ZE-4MN64C	64	1.8	4.7	Lead-Free csBGA	64	48	C
	LC4064ZE-5MN64C	64	1.8	5.8	Lead-Free csBGA	64	48	C
	LC4064ZE-7MN64C	64	1.8	7.5	Lead-Free csBGA	64	48	C
	LC4064ZE-4MN144C	64	1.8	4.7	Lead-Free csBGA	144	64	C
LC4064ZE-5MN144C	64	1.8	5.8	Lead-Free csBGA	144	64	C	
LC4064ZE-7MN144C	64	1.8	7.5	Lead-Free csBGA	144	64	C	
LC4128ZE	LC4128ZE-5TN100C	128	1.8	5.8	Lead-Free TQFP	100	64	C
	LC4128ZE-7TN100C	128	1.8	7.5	Lead-Free TQFP	100	64	C
	LC4128ZE-5TN144C	128	1.8	5.8	Lead-Free TQFP	144	96	C
	LC4128ZE-7TN144C	128	1.8	7.5	Lead-Free TQFP	144	96	C
	LC4128ZE-5UMN132C	128	1.8	5.8	Lead-Free ucBGA	132	96	C
	LC4128ZE-7UMN132C	128	1.8	7.5	Lead-Free ucBGA	132	96	C
	LC4128ZE-5MN144C	128	1.8	5.8	Lead-Free csBGA	144	96	C
	LC4128ZE-7MN144C	128	1.8	7.5	Lead-Free csBGA	144	96	C
LC4256ZE	LC4256ZE-5TN100C	256	1.8	5.8	Lead-Free TQFP	100	64	C
	LC4256ZE-7TN100C	256	1.8	7.5	Lead-Free TQFP	100	64	C
	LC4256ZE-5TN144C	256	1.8	5.8	Lead-Free TQFP	144	96	C
	LC4256ZE-7TN144C	256	1.8	7.5	Lead-Free TQFP	144	96	C
	LC4256ZE-5MN144C	256	1.8	5.8	Lead-Free csBGA	144	108	C
	LC4256ZE-7MN144C	256	1.8	7.5	Lead-Free csBGA	144	108	C

Industrial

Device	Part Number	Macrocells	Voltage	t _{PD}	Package	Pin/Ball Count	I/O	Grade
LC4032ZE	LC4032ZE-5TN48I	32	1.8	5.8	Lead-Free TQFP	48	32	I
	LC4032ZE-7TN48I	32	1.8	7.5	Lead-Free TQFP	48	32	I
	LC4032ZE-5MN64I	32	1.8	5.8	Lead-Free csBGA	64	32	I
	LC4032ZE-7MN64I	32	1.8	7.5	Lead-Free csBGA	64	32	I
LC4064ZE	LC4064ZE-5TN48I	64	1.8	5.8	Lead-Free TQFP	48	32	I
	LC4064ZE-7TN48I	64	1.8	7.5	Lead-Free TQFP	48	32	I
	LC4064ZE-5TN100I	64	1.8	5.8	Lead-Free TQFP	100	64	I
	LC4064ZE-7TN100I	64	1.8	7.5	Lead-Free TQFP	100	64	I
	LC4064ZE-5MN64I	64	1.8	5.8	Lead-Free csBGA	64	48	I
	LC4064ZE-7MN64I	64	1.8	7.5	Lead-Free csBGA	64	48	I
	LC4064ZE-5UMN64I	64	1.8	5.8	Lead-Free ucBGA	64	48	I
	LC4064ZE-7UMN64I	64	1.8	7.5	Lead-Free ucBGA	64	48	I
	LC4064ZE-5MN144I	64	1.8	5.8	Lead-Free csBGA	144	64	I
LC4064ZE-7MN144I	64	1.8	7.5	Lead-Free csBGA	144	64	I	
LC4128ZE	LC4128ZE-7TN100I	128	1.8	7.5	Lead-Free TQFP	100	64	I
	LC4128ZE-7UMN132I	128	1.8	7.5	Lead-Free ucBGA	132	96	I
	LC4128ZE-7TN144I	128	1.8	7.5	Lead-Free TQFP	144	96	I
	LC4128ZE-7MN144I	128	1.8	7.5	Lead-Free csBGA	144	96	I
LC4256ZE	LC4256ZE-7TN100I	256	1.8	7.5	Lead-Free TQFP	100	64	I
	LC4256ZE-7TN144I	256	1.8	7.5	Lead-Free TQFP	144	96	I
	LC4256ZE-7MN144I	256	1.8	7.5	Lead-Free csBGA	144	108	I

1. Contact factory for product availability.

For Further Information

In addition to this data sheet, the following technical notes may be helpful when designing with the ispMACH 4000ZE family:

- TN1168, [ispMACH 4000ZE Timing Model Design and Usage Guidelines](#)
- TN1174, [Advanced Features of the ispMACH 4000ZE Family](#)
- TN1187, [Power Estimation in ispMACH 4000ZE Devices](#)
- [Package Diagrams](#)

Technical Support Assistance

Hotline: 1-800-LATTICE (North America)
 +1-503-268-8001 (Outside North America)

e-mail: techsupport@latticesemi.com

Internet: www.latticesemi.com

Revision History

Date	Version	Change Summary
April 2008	01.0	Initial release.
July 2008	01.1	Updated Features bullets.
		Updated typical Hysteresis voltage.
		Updated Power Guard for Dedicated Inputs section.
		Updated DC Electrical Characteristics table.
		Updated Supply Current table.
		Updated I/O DC Electrical Characteristics table and note 2.
		Updated ispMACH 4000ZE Timing Model.
		Added new parameters for the Internal Oscillator.
		Updated ORP Reference table.
		Updated Power Supply and NC Connections table.
		Updated 100 TQFP Logic Signal Connections table with LC4128ZE and 4256ZE.
		Updated 144 csBGA Logic Signal Connections table with LC4128ZE and 4256ZE.
		Added 144 TQFP Logic Signal Connections table.
August 2008	01.2	Data sheet status changed from advance to final.
		Updated Supply Current table.
		Updated External Switching Characteristics.
		Updated Internal Timing Parameters.
		Updated Power Consumption graph and Power Estimation Coefficients table.
		Updated Ordering Information mark format example.
December 2008	01.3	Updated ispMACH 4000ZE Family Selection Guide table to include 64-ball ucBGA and 132-ball ucBGA packages.
		Updated ispMACH 4000ZE Power Supply and NC Connections table to include 64-ball ucBGA and 132-ball ucBGA packages.
		Added Logic Signal Connections tables for 64-ball ucBGA and 132-ball ucBGA packages.
		Updated Part Number Description diagram for 64-ball ucBGA and 132-ball ucBGA packages.
		Updated Ordering Information tables for 64-ball ucBGA and 132-ball ucBGA packages.
May 2009	01.4	Correction to t_{CW} , t_{GW} , t_{WIR} and f_{MAX} parameters in External Switching Characteristics table.
June 2011	01.5	Added copper bond package part numbers.
		Added footnote 4 to Absolute Maximum Ratings.
February 2012	01.6	Updated document with new corporate logo.
February 2012	01.7	Removed copper bond packaging information. Refer to PCN 04A-12 for further information.
		Updated topside marks with new logos in the Ordering Information section.