

EA uniTFT

Multifunction 5" TFT HMI



FEATURES

- WITH and WITHOUT TOUCHPANEL
- ANALOGUE RESISTIVE TOUCH OR CAPACITIVE - PCAP
- OBJECT BASED SCREEN DESIGN
- CHANGE OBJECTS: SIZE, SHAPE, COLOR, VISABILITY, CONTENT
- VECTOR GRAPHICS, LOSS FREE ROTATION AND ZOOM
- ALPHA BLENDING, MOVING OBJECTS
- VECTORIZED CHARACTER SET AS ASCII AND UNICODE
- SINGLE SUPPLY 3.3 V
- 7 INTERFACES: USB, 2 x I²C, 2 x SPI, 2 x RS232
- 16 DIGITAL I/O ONBOARD, EXPANDABLE UP TO 125
- 4 ANALOGUE INPUTS
- PWM OUTPUT
- BUILT-IN RTC INCL. BATTERY BACKUP
- MICRO SD-CARD USED FOR PICTURES, FONTS, MACROS

ORDERING CODES

DISPLAYS

MULTI FUNCTION 5" TFT 800x480 DOTS, 24 BIT WITH BACKLIGHT

INCL. RESISTIVE TOUCHPANEL

INCL. CAPCITIVE TOUCHPANEL - PCAP

ACCESSORIES

5" uniTFT WITH PCAP PLUS PROGRAMMER BOARD

5" uniTFT WITH RES: TOUCH PLUS PROGRAMMER BOARD

MICROMATCH CONNECTOR THT, 26 PIN (2 PCS. REQUIRED)

MICROMATCH CONNECTOR IDC CRIMP CONNECTION, 26 PIN (2 PCS. REQUIRED)

EA uniTFT050-A

EA uniTFT050-ATP

EA uniTFT050-ATC

EA QUICKuniTFT050C

EA QUICKuniTFT050P

EA B2B127M-26T

EA B2B127M-26Q

TABLE OF CONTENT

Features	1
Ordering codes	1
Table of content	2
Revision	5
General information	6
Method of working of the display	6
Objects	6
Styles	6
Drawing style and line style	6
Text style	6
Button style	6
Styles and objects	6
Command syntax	7
Command parameters	8
Angels	8
Comments	9
Object area	9
Entering figures	10
Entering strings	10
String file	10
Path details, Files and Formatting	12
Path details	12
Data Types	13
Formatted strings	13
Date and Time	14
Images	15
Image formats	15
Polyline and polygons	16
Segment	16
Indicators	16
Directions of movement and arcs	16
Anchor	18
Groups	19
Calculation	20
Action and Animation	25
ACtion	25
Animation	25
safety instructions	25
Avoid electric shock and fire	25
Care and use	25
Hardware	27
Pin assignment	27
RS232	28
Data format	28
Baud rates	28
Application examples	29
RS232 V24 - connection to a PC	29
RS485 - bus system	29
SPI	30
I ² C	32
USB	33
SD CARD	34

Video input/camera	34
AnalogUE Input	35
Pulse width modulation (PWM)	36
Input/Output (I/O)	37
Short Protocoll & Small Protocoll	38
Short Protocoll	40
Small Protocoll	42
Checksum calculation	43
Short Protocoll	43
Small Protocoll	44
Commands	45
Command overview	45
Terminal	45
Images/vector graphics	47
Add image/vector graphic.	47
Types of animation	48
Style sheets	49
Colour gradients and line patterns	49
Drawing style	49
Line style	51
Text style	52
Touch button style	53
Drawing/graphic primitives	55
Segment types	58
Strings and character string commands	59
Edit box	60
Touch objects / Touch functios	62
Definition of Touch objects	62
Touch functions	63
Bar graphs and instruments	65
ObjectS	68
Definition of Objects	68
Change of objects	69
Variables and Registers	72
Macros	74
Executing macros	74
Definition of macro processes and touch macros	75
Types of analogue macros	76
Time and date	78
Action	79
Operational curves and paths	79
Define action	79
Action	79
Define Actions	81
Action type	82
Pre-defined action curves	83
Keyboard	88
Peripherals - interface	90
Analogue	90
Pulse width modulation (PWM)	91
Port	91

Video and Audio	92
RS232 Master interface	92
Spi Master interface	93
I ² c	95
System commands	96
Boot menu and touch adjustment through gestures	98
File access	100
SD-Card	100
File time	102
Responses	103
Examples of commands	106
Operation and animation	107
Bild / Vektorgrafiken	110
Ein- und Ausgänge	111
Instruments	112
Keyboard	114
String Zeichenkettenbefehle	115
Editbox	116
Style sheets	117
Terminal commands	121
Touch control objects/touch control functions	122
Time	123
Drawing/graphic primitives	124
Segmenttypen	127
Commands for the examples	130
Operation and animation	130
Instruments	135
Keyboard	139
Character string commands in a string	140
Style sheets	141
Terminal commands	145
Touch control objects/touch control functions	146
Time	147
Drawing/graphic primitives	148
Segment types	151
Electrical Specification	158
dimensions	159

REVISION

Datum	Version / Firmware	Beschreibung
23.08.2016	0.9	First release

GENERAL INFORMATION

METHOD OF WORKING OF THE DISPLAY

The representation on the display is effected based on the commands given by the user. Every item on the display is an independent [object](#) and can be manipulated. The appearance, i.e. the colour data, the fonts, the line strengths, etc. is merged to form [styles](#) .

OBJECTS

In order to generate various objects, the corresponding commands are available. Every image, every text and every button is a so-called object. Every object needs to be endorsed with an object ID which makes it clearly identifiable. If an object ID is assigned, and if said object ID is re-assigned the previous object is overwritten. Thus, when using objects that occur on multiple screen pages, care is needed so that the latter are not overwritten.

STYLES

There are various styles based on which objects can be displayed, such as colour, line strength or transparency. The corresponding commands and examples can be inferred from the [Style Sheets](#) section.

Just as with the objects, styles are saved in corresponding IDs, which can also be overwritten. The various style groups have their own ID range. That means that a button style and a drawing style with the ID 1 can exist alongside one another simultaneously. The maximum number of styles is 255 for every range, which is why using a local definition needs to be taken into consideration when using very many styles.

DRAWING STYLE AND LINE STYLE

Except in the case of images, every object is generated with a border and a filling. The drawing style determines precisely those. In that respect, both the [filling](#) and the [border](#) (line) can be defined, omitted entirely or designed to be transparent. Besides having a plain colour filling, a colour gradient is, moreover, also possible. In the case of the line, it is not possible to define a colour gradient. In addition, both a dash pattern (dotted) can be defined, and also the ends rounded off. The line style is a component of the drawing style, which is why it is recommended for the overview to always specify both together.

TEXT STYLE

The [Text Style](#) needs to be defined if it is intended to work with strings. The latter contain the information on the font used, as well as its formatting. As a string is likewise an object, reference is also made, in the text style, to an existing drawing style, in order to provide the font with a filling and border. For performance reasons, we recommend a drawing style without a border (line).

BUTTON STYLE

Text and drawing styles form the basis for the [Button Style](#). In order to design touch control buttons which have a different visual appearance in the pressed state, in comparison to the unpressed state, in certain circumstances multiple drawing and text styles are required. Information, such as touch feedback, e.g. playing short jingles upon activation or enlarging the button is likewise stored in this style.

STYLES AND OBJECTS

In order to be able to switch between various different screen pages, all the existing objects first always need to be [deleted](#) Precisely in menus, you can often find a fixed structure, so that individual objects only need to be

deleted in a targeted manner, and others can remain in place.

Below is an example, to make it clear how handling objects works.

Once the display has been started, a main menu is opened, with a background (ID=100), Logo(ID=101) and two touch buttons(ID= 1,2) for selecting the sub-menu. A button style(number=1) is, furthermore, defined for the touch control buttons.

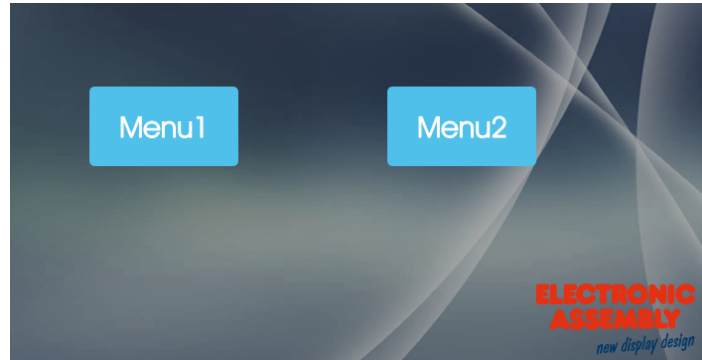

The background, logo and button style should also be present in the sub-menus. In order not to overwrite these objects, using the object IDs should be discontinued. A heading with a corresponding style, as well as a line, are supposed to be generated in Menu 1. All objects still existing that are no longer required are to be deleted in advance. In this case that is Objects 1 to 99. The deletion is performed by entering the delete command for objects(→ [#ODI 1-99](#)). The result can be seen in the figure below.



Naturally, the objects in Menu 1 and Menu 2 can be used in the same way.

COMMAND SYNTAX

A command always begins with '#'. Subsequently there is a 3-digit sequence of digits - the command code. Depending upon the command code, further parameters are required. In order to separate the parameters, one of the following characters needs to be used:

- Space
- Comma(,)
- Full stop(.)
- A semicolon (;) (only and mandatorily at the end of a string)
- Specified range of multiple object IDs: '-' sign: e.g. 1-5, instead of 1,2,3,4,5.

The command always needs to be concluded by an LF (line feed) Should the line feed not exist, the command is not executed.

Example::

EA uniTFT Vorläufig

- Individual command to generate Line Style 1 `#CLS1 $3B7EAE,100,1,0,1(Line Feed)`
- Multiple commands to generate an animation of Object 1 `#AOA1 501,0 (Line Feed)`
`#AOT1 1,250,100,100 (Line Feed)`

There are commands which relate to files. Those are likewise written in quotation marks or inverted commas. These commands have recorded in them, as their reference point, the default folder, and thus an automated path specification.

COMMAND PARAMETERS

Parameters that are written in **GRAY** in the command tables are considered optional details, and partially have default values. The default values are given in brackets behind the corresponding parameters. Parameters written in **BLACK** must be transferred.

ANGELS

Angles are specified in the mathematical direction of rotation, i.e. anti-clockwise. It is likewise possible to enter negative angles. The direction of rotation and the angular distribution can be discerned in the figure below.

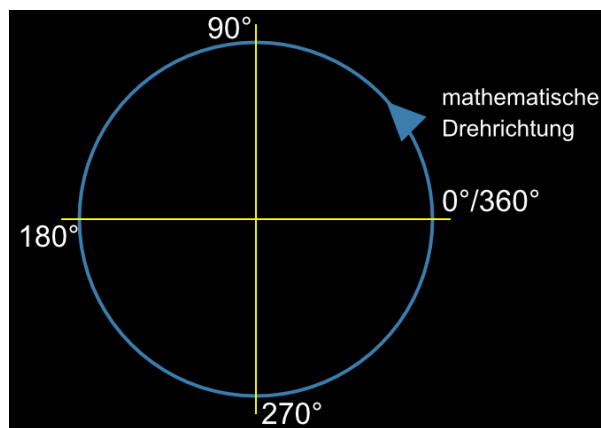

The co-ordinate system extends in a range from 800(x) * 480(y). The origin (0/0) is in the lower left-hand corner.

COMMENTS

The option exists to add comments in the command input in macro files. Considerations concerning command sequences can be explained thereby, and a better understanding ensured. A comment begins with #- (hash key minus) and applies until the end of the line, i.e. once the comment line is supposed to contain a wrap, the next line likewise has to begin with #- in order to continue the comment.

OBJECT AREA

In the case of commands having the property of influencing one or more objects (marked by: "Object ID"), the object area can be specified by a hyphen, "-". In the example contained in the section, [Styles and Objects](#), the application is highlighted.

ENTERING FIGURES

Input	Definition
123	Decimal handover as ASCII character/s
\$5A	Hexadecimal handover as ASCII character/s
%101001	Binary handover as ASCII character/s
?x	Code of a character (Unicode /ASCII)
R0..R255	Handover of the register value
Q0..Q255	Accept register value indexed = R(R0..255).
(...)	Accept result of the calculation string
G len32 data...	Submit binary data: G len 32-bit - binary, followed by binary data
!string!	Infer values and strings from string file, replacement

ENTERING STRINGS

Should strings be used as parameters, it should be remembered that the latter need to be placed in quotation marks ("") or inverted commas (' '), and be ended by a semicolon (;). Should a string be the last parameter in the command code, no semicolon needs to be placed at the end of the string. The maximum length permitted for any string is 255 characters. A line break within a string is implemented with the pipe sign '|' or new line '\n'.

- Beispiel: "string1"; 'string2'

Eingabe	Definition
"Hello"32'World'	Eingabe eines Strings. Da kein ; vorhanden ist werden die Strings zusammengesetzt. Der Code dazwischen wird ebenso eingefügt. Ausgabe: Hello World
"Hello\nWorld" = "Hello World"	Mehrzeilige Eingabe eines Strings
S0..255	Stringregister übernehmen.
T0..255	Stringregister indiziert übernehmen, Stringregisternummer aus Register S(R0..255).
U"Hello"	Zeichen nach dem U als 16-Bit Unicode (bis zum nächsten # oder V auch CR + LF)
V"Hello"	Zeichen nach dem V als 8-Bit ASCII (bis zum nächsten # oder U auch CR + LF)
!string!	Werte und Strings aus Stringdatei entnehmen und einsetzen.

STRING FILE

String files are text files written externally. String files can be used as a sort of database of strings. The strings stored in such a way can be accessed by the name for accessing the string being written between two exclamation marks ! No quotation marks "" may be used, as otherwise only the access as a string is shown, however the desired string file is not loaded. To use this function, the text file created only needs to be found in the String folder of the SD card, and be loaded by the command to load a string file ([#VFL](#)) . By way of clarification, an example is given below:

The text file *Hallo.txt* created externally and copied onto the SD card looks as follows:

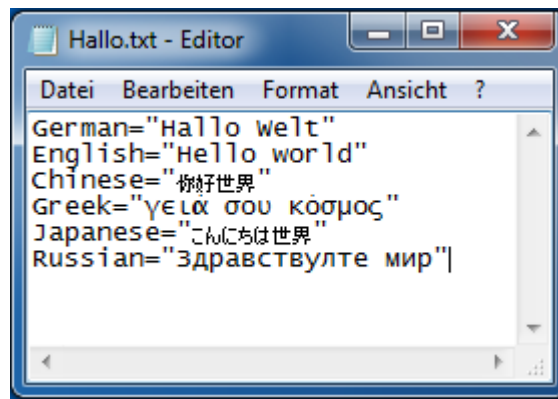

Silt serves the purpose of using multilingualism in regard to the statement "Hello, World". The text file is first of all loaded through [#VFL](#) "Hallo". Should a string now be placed by the command [#SSP](#) 1, 1, 400, 240, 5 !German!
"!English!", the result looks as follows:

Hallo Welt
Hello World

The pipe sign | is necessary for the line break. So that it counts for the string to be displayed, the latter needs to be written in quotation marks ""Without using the string file, the above command would read [#SSP](#) 1, 1, 400, 240, 5 "Hallo Welt" "|" "Hello World".

PATH DETAILS, FILES AND FORMATTING

PATH DETAILS

There are two ways of indicating the path. In absolute and relative terms, respectively.

Designation	Example
Absolute path details	</Ordner/Unterordner>
Relative path details	<.../Unterordner>

The absolute path details should be used to work with files outside the project path set. The project path, which is defined by the command [XPS](#) serves to simplify matters. It is not necessary to specify the superordinate directories. By entering "P:" prior to specifying the path, the project paths are automatically added.

If a file is to be accessed in the project folder "picture" set, that can be done absolutely or relatively, as shown in the following example:

Absolute path details: </Ordner/Ordner/Ordner/Projekt/picture/Test.epg

Relative path details: <p:/picture/Test.epg → The project path has been set as "[#XPS](#) </Ordner/Ordner/Ordner/Projekt>"

When specifying the path, upper and lower case are to be taken into account.

One more simplification::

There is a series of default folders that are automatically created in the project folder and may NEVER be changed, as, otherwise, command parameters that automatically access these folders no longer work!

This folder structure is defined as follows:

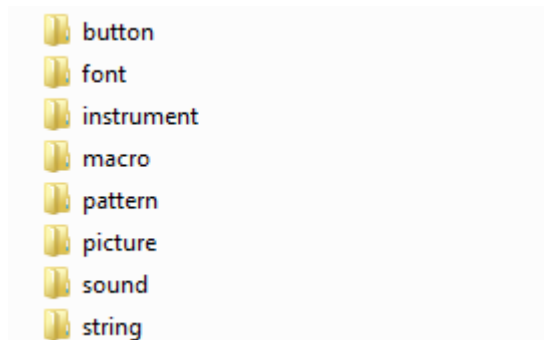

Example:

[#PPP1](#), "Test", 100, 100

With this command, the "test" image is shown on the display at the position 100,100.

An alternative programming step would be: [#PPP1](#), <P:/picture/Test.epg>, 100, 100 .

The same occurs with macros, string files (rather than strings), patterns, buttons (images), sounds, instruments and fonts. The default folders may never be changed. Sub-folders in the default folders are allowed, however need to be specified as well in file names.

DATA TYPES

Zur Verwendung von Bild- oder Sounddateien müssen diese umgewandelt beziehungsweise konvertiert werden. Das geschieht automatisch durch die Verwendung der Software *uniSKETCH*, indem dort die Dateien eingebunden werden.

Das uniTFT kann nur mit folgenden Dateitypen arbeiten:

Dateityp	Beschreibung
.evg	Format für Vektorgrafiken
.epa	Format für animierte Bilder
.epg	Format für Pixelgrafiken
.esd	Format für Sounddateien
.evf	Format für Vektorfonts
.epf	Format für Pixelfonts
.epi	Format für Pixelinstrumente
.emc	Format für Macros (Das Makro <i>start.emc</i> startet automatisch nach PowerOn oder Reset.)
.txt	Format für Stringfiles

Andere Dateiformate können zwar im internen Speicher abgelegt, jedoch nicht vom uniTFT genutzt werden.

FORMATTED STRINGS

Formatted strings rely on the “printf” output function of C. It is thereby possible to display a string that, for example, contains numerical values of a calculation. The maximum length permitted for any formatted string is 63 characters.

Designation	Character	Description
Integer	%d	Displays number as a string.
Double	%f	Displays numbers with a decimal place as a string.
Hexadezimal	%x, %X	Displays hexadecimal numbers as a string.

A formatted string could look as follows:

[#SFP](#)1, 3, 400, 240, 5, "Integer: %d, Float: %.5f, Hexadezimal: %X"; (1+1+1), (3.14159265359), (9+6)

With corresponding text and drawing styles, the result appears as follows:

Integer: 3, Float: 3.14159, Hexadezimal: F

DATE AND TIME

The file format is a special form of the formatted string and describes the date, including the time. A further explanation on the date format can be found [here \(#WDF\)](#).

In the table below, the input commands for the file format are listed.

Eingabe	Definition
%[]h	Hour
%[]m	Minute
%[]s	Second
%[]D	Day
%[]M	Month
%[]Y	Year
%{ }W	Name of weekday as a string
%{ }N	Name of month as a string
[] (optional)	0 = Two digits with a preceding 0 (Default) 1 = At least one digit without a preceding character 2 = Two digits with preceding blank spaces 4 = Four digits (default for years)
{ } (optional)	0...9 = Display the first X characters from the string.

Example:

#SDP

Date and Time
 Placing a formatted date

[#SDP](#) 1, 1, 50, 50, 17, "%W the %D. %3N %Y, %1h:%m"

Thursday the 21. Apr 2016, 11:37

IMAGES

The module internally uses a special image format (*.epg). The conversion needs to be done externally. The Windows program EA uniSketch offers the most comfortable option to have most image formats converted. Some [commands](#) make it possible to save the screen content on the SD card or transfer image data directly via the serial interface. Various [image formats](#) are available here.

IMAGE FORMATS

The following image formats apply to screenshots/hard copies of the display or the video input.

Input	Definition	Storage space requirement/execution time	requi-
1	BMP 24Bit → True Color	Very high	
2	BMP 16Bit → High Color	High	
3	BMP 8Bit grey → grey-scale image	Low	
11	epg 32Bit → True Color with alpha channel	Very high	
12	epg 16Bit → High Color	High	
13	epg 8Bit grey → grey-scale image	Low	
21	epg 32Bit RLE compressed → see above	High	
22	epg 16Bit RLE compressed → see above	Medium	
23	epg 8Bit grey RLE compressed → see above	Very low	

POLYLINE AND POLYGONS

With the polyline ([#GPL](#)) and polygon ([#GPF](#)) commands, virtually all desired forms can be generated. Each section is designated a segment.

SEGMENT

A segment is generally a section or a part of something whole.

In the present command application, the segments fulfil two primary aspects. Firstly, graphics, and, secondly, operational paths, can be created, segment by segment. As a result, freely selectable forms find their way into the design of the layout.

INDICATORS

Each segment contains an indicator in the form of a character whereby the type of segment is recognised. The list of indicators can be found [here in the command overview](#).

A segment entered always begins with "?", and the indicator, as well as the corresponding parameters, are added subsequently. In that respect, as many segments as desired can be linked with one another. There is furthermore a difference, in the case of the indicators, between upper and lower case, which represents the difference between absolute and relative co-ordinates.

Here is an example:

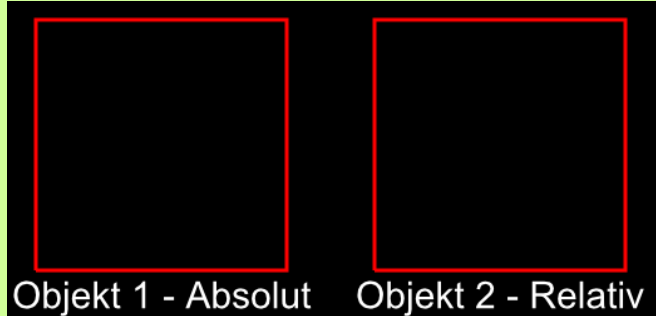
Generating a square with absolute and relative segment details	
<pre>#GPP1, 1, 100, 100, ?V, 300, ?H, 300, ?V, 100, ?H, 100 #GPP2, 1, 370, 100, ?v, 200, ?h, 200, ?v, -200, ?h, -200</pre>	

In this example, two identical squares are generated by linking horizontal and vertical lines. Object 1 is generated absolutely, in other words the absolute co-ordinates of the display need to be specified for positioning the line points. By connecting the point co-ordinates, the corresponding lines are generated from the latter. In the case of Object 2, on the other hand, only the starting point is defined absolutely. In regard to this starting point, the lengths of the respective lines are now specified. Thus, this square relates to the starting point relatively.

DIRECTIONS OF MOVEMENT AND ARCS

The direction of movement is to be observed with the circular segments. Depending upon the direction of movement, another segment is generated.

In the table below, a segment is defined as a full ellipse, with a starting point and an end point. Due to the radii of the ellipse being given, four options exist for linking the starting point with the end point. The four options differ in regard to the two directions of movement and the two potential arcs. The small arcs are marked red. The two large arcs have been highlighted in green. The clockwise directions of movement are shown darker.

With circles, the differentiation according to large and small arcs does not make a difference. This is due to the fact that a circle only has a radius, as a result of which the large and small arcs are identical.

Highlighting the arcs and directions of movement

#GPP1, 1, 390, 380, ?E0, 200, 70, 25, 340, 260
#GPP2, 2, 390, 380, ?E1, 200, 70, 25, 340, 260
#GPP3, 3, 390, 380, ?E2, 200, 70, 25, 340, 260
#GPP4, 4, 390, 380, ?E3, 200, 70, 25, 340, 260

0: Small anti-clockwise arc
1: Small clockwise arc
2: Large anti-clockwise arc
3: Large clockwise arc

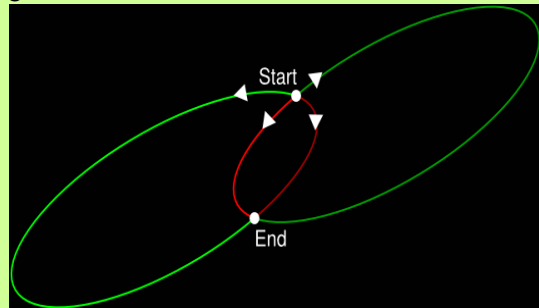

ANCHOR

All objects can be created at a position (x, y). By specifying the anchor numbers, it can now be determined whether the object is e.g. with the upper left corner (anchor 1), or e.g. exactly in the middle (anchor 5). In the case of multiline texts, there are further anchors (11-19) which refer to the baseline of the text. In the table below, a string is displayed to illustrate the anchors:

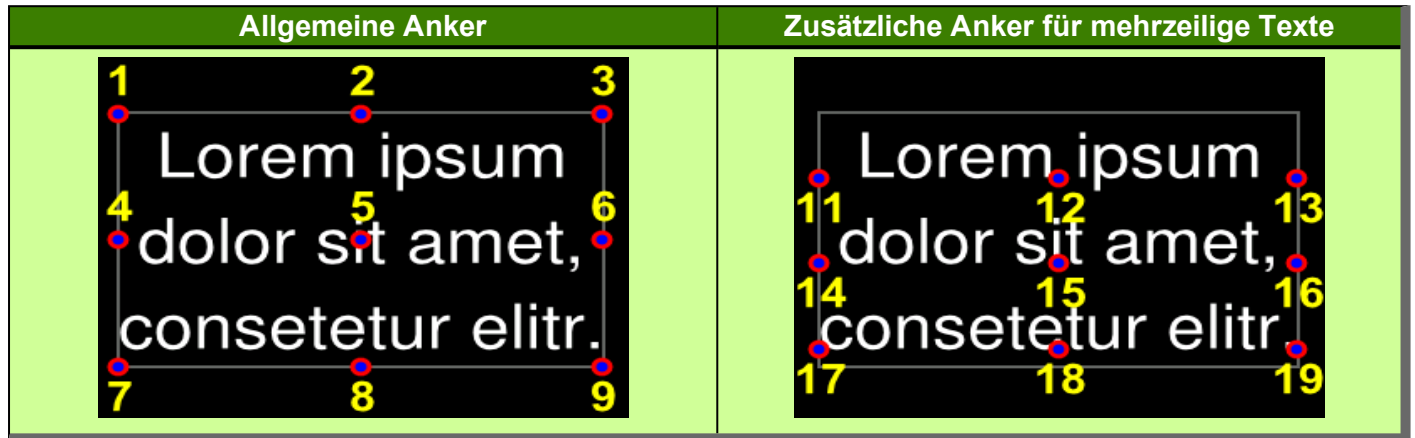

In addition to the above anchor numbers, there is also anchor 0. Anchor 0 is a special anchor, which can be arbitrarily set by corresponding commands. Thus, for example, an object is able to rotate around a desired point. In the following example, a round thermometer is shown:

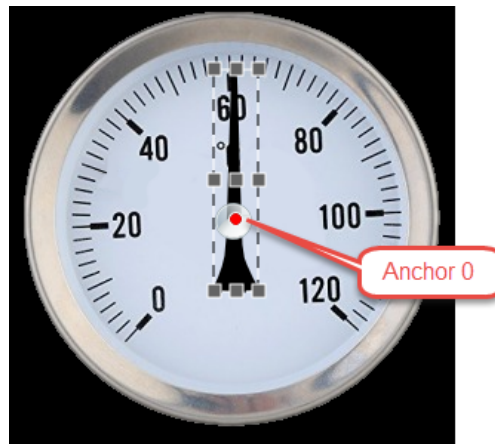

The pointer should turn around the center of the instrument. With the general anchors, which are represented as small gray squares, the pointer can also rotate around the center of the thermometer. The standard anchors 1 to 9 are not suitable for this purpose. Therefore, in this case, an individual anchor 0 is determined. This can be determined by pixel accuracy and is shown in red in the image. The pointer is now rotated around this anchor point.

GROUPS

Groups simplify the simultaneous handling of several objects. The desired objects are grouped together in an object group, but they retain their individual functions and definitions. The advantage is that all objects of the group can be affected at the same time, for example a shift, a rotation or a fade-out. In addition to the simple object groups, there are also groups for touch switches. These ensure that only one switch of the group is active (radio buttons), which means that not every switch has to be defined individually with such a function.

Attention: Group IDs and object IDs are in the same number space and thus overwrite each other.

CALCULATION

Each numerical parameter can be replaced by a calculation. The calculation needs to be enclosed in brackets ().

Name	Command	Description	Integer	Float
Mathematical functions	+, -, *, /, ()	Arithmetical functions	✓	✓
x (amount)	abs(x)	Calculation of absolute value	✓	✓
x%y (modulo)	mod(x,y)	Calculation with remainder	✓	
x^y (power)	pow(x,y)	Calculation with power	✓	✓
Root	sqrt(var)	Calculating the root		✓
Logarithm	log(var)	Calculating the logarithm		✓
Natural logarithm	ln(var)	Calculating the natural logarithm		✓
Degrees to radians	rad(deg)	Converting degrees to radians		✓
Radians to degrees	deg(rad)	Converting radians to degrees		✓
Sine	sin(deg)	Calculating the sine		✓
Cosine	cos(deg)	Calculating the cosine		✓
Tangent	tan(deg)	Calculating the tangent		✓
Arc sine	asin(var)	Calculating the arc sine		✓
Arc cosine	acos(var)	Calculating the arc cosine		✓
Arc tangent	atan(var)	Calculating the arc tangent		✓
Arc tangent in the correct quadrant	atan(y,x)	Calculating the arc tangent in the correct quadrant		✓
Random value in the range	rand(sv,ev)	Random value in the range of values	✓	✓
Random value 0 - ev	rand(ev)	Random value greater than 0	✓	✓
Random value 0<= x<=1000	rand()	Random value greater than 0; smaller than 1000	✓	✓
Minima	min(a,b,c...)	Smallest value	✓	✓
Maxima	max(a,b,c...)	Largest value	✓	✓
Average	avg(a,b,c...)	Average	✓	✓
Bit operators	<<, >>, &, , ^, ~	Bit Operatoren	✓	
Logical operators	<, >, <=, >=, !=, ==, &&, , !	Logical operators	✓	✓
Increase, reduce	++,--	Increase, reduce	✓	✓
Port (a=0..15) = 0..255	port(a)	Port value	✓	✓

EA uniTFT Vorläufig

Name	Command	Description	Integer	Float
Portbit (a=0..127) = 0/1	bit(a)	Bit value	✓	✓
Analogport (a=0..3) = 0..4095	analog(a)	Analogue port value	✓	✓
Current date in seconds	date()	Current date	✓	
Day in seconds	date(D)	Current day	✓	
Day + month + year (1932 - 2067) in seconds	date(D,M,Y)	Any date desired	✓	
Current time in seconds	time()	Current time	✓	
Hour to seconds	time(h)	Current hour	✓	
Hour + mins to seconds	time(h, m)	Current hour and minute	✓	
Hour + min. + sec. in seconds	time(h, m, s)	Current hour, minute and second	✓	
Current time and date	datetime()	Current date with time	✓	
Hour +min.+sec. + Day+month+year to seconds	datetime(h,m,s,D,M,Y)	Any desired date and time specification	✓	
Current year	year()	Current year	✓	
Seconds as from 01/01/2000, 0:00:00 to year	year(a)	Save year	✓	
Current month	month()	Current month	✓	
Seconds as from 01/01/2000, 0:00:00 to month	month(a)	Save month	✓	
Current day	day()	current day	✓	
Seconds as from 01/01/2000, 0:00:00 to days	day(a)	save day	✓	
Current weekday (0=Sunday)	weekday()	Current weekday	✓	
Seconds as from 01/01/2000, 0:00:00 to weekday	weekday(a)	Save weekday	✓	
Current hour	hour()	Current hour	✓	
Seconds as from 01/01/2000, 0:00:00 to hours	hour(a)	Save hour	✓	
Current minute	minute()	Current minute	✓	
Seconds as from 01/01/2000, 0:00:00 to minutes	minute(a)	Save minute	✓	
Current second	second()	Current second	✓	
Seconds as from 01/01/2000, 0:00:00 to seconds	second(a)	Save second	✓	
Global 10 ms timer	timer()	Global timepiece 10ms	✓	
24-bit colour red channel	getR(x)	Determine colour portion red	✓	

Name	Command	Description	Integer	Float
24-bit colour green channel	getG(x)	Determine colour portion green	✓	
24-bit colour blue channel	getB(x)	Determine colour portion blue	✓	
24-bit colour RGB	RGB(R, G, B)	Determine colour completely	✓	
Displays RGB of ramp number	rampRGB(nr, offset)	Displays colour of colour gradient	✓	✓
Displays transparency of ramp number	rampO(nr, offset)	Displays transparency of colour gradient	✓	✓
Display width	scrW()	Width of the display	✓	✓
Display height	scrH()	Height of the display	✓	✓
Video width	vidW()	Width of the video	✓	✓
Video height	vidH()	Height of the video	✓	✓
Number of video objects	vidC()	Number of video objects	✓	✓
Object width (without transformation)	objW(id)	Width of the object	✓	✓
Object height (without transformation)	objH(id)	Height of the object	✓	✓
Object position x of the current anchor	objX(id)	X position of the object	✓	✓
Object position x of any desired anchor	objX(id, anchor)	X position of the object		
Object position Y of the current anchor	objY(id)	Y position of the object	✓	✓
Object position Y of any desired anchor	objY(id, anchor)	Y position of the object		
Object scaling, width	objSW(id)	Scaling of the object width	✓	✓
Object scaling, height	objSH(id)	Scaling of the object height	✓	✓
Object shearing X	objSX(id)	Shearing in the X direction of the object	✓	✓
Object shearing Y	objSY(id)	Shearing in the Y direction of the object	✓	✓
Object rotation	objR(id)	Rotation of the object	✓	✓
Object opacity	objO(id)	Transparenz des Objekts	✓	✓
Object level	objL(id)	Ebene des Objekts	✓	✓
Object Style Number	objC(id)	Style Nummer der Objekts	✓	✓
Current object anchor	objA(id)	Current anchor of the object	✓	✓
Instrument bar of current value	objIV(id)	Current instrument value	✓	✓

Name	Command	Description	Integer	Float
Instrument bar of drawn value	objID(id)	Drawn instrument value	✓	✓
Instrument bar of end value	objE(id)	End value of the instrument	✓	✓
Instrument bar start value	objS(id)	Start value of the instrument	✓	✓
Displays the length of the action path	pathL(id)	Länge des Aktionspfades	✓	✓
Displays relative X co-ordinates from the beginning of the action path	pathX(id,distance)	X position beginning of path	✓	✓
Displays relative Y co-ordinates from the beginning of the action path	pathY(id,distance)	Y position beginning of path	✓	✓
Displays the angle of the tangent of the action path	pathR(id,distance)	Tangential angle of the path	✓	✓
Displays touch button/switch status	butS(id)	Status button or switch	✓	✓
Displays the active touch switch of the radio group	butR(groupid)	Active switch in group	✓	✓
Displays last key/switch pressed	butI()	Last switch pressed	✓	✓
Displays code of the last keyboard keys	butC()	Last key pressed on the keyboard	✓	✓
Displays the length of the string	strL(nr)	Length of the string	✓	
Displays ASCII code from string registers	strA(nr, pos)	ASCII code of the stored string	✓	
Displays Unicode from string register	strU(nr, pos)	Unicode of the stored string	✓	
Comparison between two string registers	strC(n1, n2)	Compare string registers	✓	
Convert numerical string into value	strV(nr)	Convert numerical string into value described	✓	✓
Checks whether file exists (<name> in String Register No.)	fileE(nr)	Check existence of the file in the string register	✓	
Gibt Dateigröße aus (<name> in Stringregister nr)	fileS(nr)	Check size of the file in the string register	✓	
Displays file size (<name> in String Register No.)	fileT(nr)	Zeit der Datei im Stringregister prüfen	✓	
Gibt Dateieigenschaft aus(<name> in Stringregister nr)	fileA(nr)	Eigenschaft der Datei im Stringregister prüfen	✓	
Displays file time (<name> in String Register No.)	fileD(nr)	Daum der Datei im Stringregister prüfen	✓	
Seconds in FatTime, 16-bit	fatT(Sekunde)		✓	
Seconds in FatDate, 16-bit	FatD(Sekunde)		✓	
Display integer calculation as a float	int(calculation)	Integer value from float calculation		✓

Name	Command	Description	Integer	Float
Display float calculation as an integer	float(calculation)	Float value from integer calculation	✓	

ACTION AND ANIMATION

Actions and animations can be used to "bring life" to objects or graphics on the display. There are significant differences between an action and an animation.

ACTION

[Actions](#) are used to change objects. For example, objects can be moved or their transparency can be changed. Accordingly, an apparent or vanishing [behaviour](#) can also be defined. If an action affects the parameters of an object, they remain on the newly assigned value.

This means, for example, if an object should disappear, it is deleted at the end of the action. By changing the position in combination with the [actions paths](#), actions also allow you to follow a defined path. Action paths have the advantage that objects can rotate, scale, position, or change their percentages as a percentage. The action sequence can be adapted via the [action curves](#). For example, a linear sequence or a process with delay or acceleration are already available as templates.

ANIMATION

Animations are only valid for GIF files as well as for color fills and line patterns. The various [animation types](#) can be used to influence the image sequence of GIFs or to animate line patterns and color fillings of graphics. For the time sequence of the animation, the [action curves](#) can be used for better adaptation, as already described for the actions.

SAFETY INSTRUCTIONS

AVOID ELECTRIC SHOCK AND FIRE

- Do not use a damaged power cord or plug.
- Do not use loose sockets.
- Do not touch the power cord with wet hands.
- Do not unplug the power cord by pulling the cord.
- Do not bend or damage the power cord

CARE AND USE

Keep the unit dry.

- Moisture and liquids of all types can damage parts of the device or electronic circuits.

Do not store the unit in dusty or dirty environment.

- Dust can cause malfunction of the unit.

Do not place the unit on inclined surfaces.

- The unit can be damaged by falling down.
- Do not place the unit near magnetic fields, as this can cause malfunction of the unit.

Do not drop or subject the unit to shocks.

EA uniTFT Vorläufig

- The screen of the unit may be damaged.
- Bending or deforming can damage both the device and parts thereof.

Only use approved original spare parts.

Do not use the unit when the display is cracked or broken.

Do not use the appliance for purposes other than those intended.

Handle memory cards with care.

- Do not remove a memory card from the device while data is being read or stored on the card. Failure to do so may result in data loss or damage to the card or device.
- Do not touch the gold-colored contacts of memory cards with your fingers or metallic objects. If the contacts are dirty, clean them with a soft cloth.

Clean the device without chemicals or solvents and use a clean cloth.

HARDWARE
PIN ASSIGNMENT

An overview on the pin assignment of the display is shown below.

Pin	Symbol	I/O	Beschreibung	Pin	Symbol	I/O	Beschreibung
1	GND		Ground 0 V	27	I/O 1.7 I/O SDA	I/O I/O	Input/Output 1.7 (Bit 15) Port Expander Serial Data
2	VDD		Power Supply 3,3 V	28	I/O 1.6 I/O SCL	I/O I/O	Input/Output 1.6 (Bit 14) Port Expander Serial Clock
3		I	!Reset	29	I/O 1.5 I/O INT	I/O I/O	Input/Output 1.5 (Bit 13) Port Expander Interrupt
4	SPI CS	I	SPI: Chip select	30	I/O 1.4	I/O	Input/Output 1.4 (Bit 12)
5	SPI MOSI	I	SPI: Serial in	31	I/O 1.3	I/O	Input/Output 1.3 (Bit 11)
6	SPI MISO	O	SPI: Serial Out	32	I/O 1.2	I/O	Input/Output 1.2 (Bit 10)
7	SPI CLK	I	SPI: Serial Clock	33	I/O 1.1	I/O	Input/Output 1.1 (Bit 9)
8	RS232 RxD	I	RS232: Receive Data	34	I/O 1.0	I/O	Input/Output 1.0 (Bit 8)
9	RS232 TxD	O	RS232: Transmit Data	35	I/O 0.7	I/O	Input/Output 0.7 (Bit 7)
10	DE (RS485)	O	RS232: Transmit Enable RS485	36	I/O 0.6	I/O	Input/Output 0.6 (Bit 6)
11	I ² C SDA	I/O	I ² C: Serial Data	37	I/O 0.5	I/O	Input/Output 0.5 (Bit 5)
12	I ² C SCL	I	I ² C: Clock Data	38	I/O 0.4	I/O	Input/Output 0.4 (Bit 4)
13	A/D 0	I	Analogeingang 0	39	I/O 0.3	I/O	Input/Output 0.3 (Bit 3)
14	USB DPn	I/O	USB Data negative	40	I/O 0.2	I/O	Input/Output 0.3 (Bit 2)
15	A/D 1	I	Analogeingang 1	41	A/D 3	I	Analogeingang 3
16	USB DPp	I/O	USB Data positive	42	A/D 2	I	Analogeingang 2
17	I/O 0.0	I/O	Input/Output 0.0 (Bit 0)	43	I ² C SCL	I	User I ² C: Clock Data
18	USB VBus		USB Supply Voltage	44	I ² C SDA	I/O	User I ² C: Serial Data
19	I/O 0.1	I/O	Input/Output 0.1 (Bit 1)	45	RS232 TxD	I	User RS232: Transmit Data
20	Testmode SBUF	I O	PowerOn low: Testmode low: Data available in sendbuffer	46	RS232 RxD	O	User RS232: Receive Data
21	PWM	O	PWM output	47	SPI CLK	O	User SPI: Serial Clock
22	DPROT	I	open (high): Protocoll active low: Protokoll deaktiviert	48	SPI MISO	I	User SPI: Serial In
23	SND+	O	Loudspeaker Output (8 Ohm)	49	SPI MOSI	O	User SPI: Serial Out
24	SND-	O	Loudspeaker Output (8 Ohm)	50	SPI CS	O	User SPI: Chip select
25	VDD		Power Supply 3,3 V	51	VIN		Power Supply 3,3 V
26	GND		Ground 0 V	52	GND		Ground 0 V

RS232

RS232 is a standard for a serial interface. Data is transmitted serially in an asynchronous manner. The data is thus converted into a bit stream and transmitted. No common clock line exists. In other words, every bus subscriber needs to work with the same transmission rate (the so-called "baud rate"). RS232 is a voltage interface. That means that the data is transmitted via a voltage level. In the PC world and industrial control systems, levels of +12V or -12V are defined as the standard. Within PCBs or in micro-controllers, it is usual to work with 0V or VDD (in the case of the EA uniTFT050 3.3 V). To adjust the signal level, there are one or two options in the form of level shifters. RS232 consists of "hearing" and "speaking" lines which are crossed between the two subscribers.

DATA FORMAT

The format for the data transmission is 8-N-1:

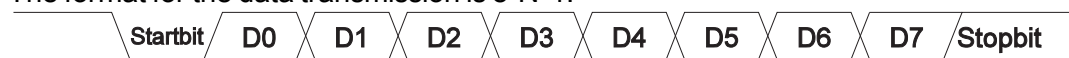

BAUD RATES

The baud rate is preset to 115.200 baud in the delivery state. The command [Beispiel siehe S. 97](#) can change the baud rates. Alternatively you can set this command also in the file <start.emc>.

Baudrates	Error rate in %
9600	+0,04
19200	-0,08
38400	+0,16
57600	-0,08
115200	+0,64
230400	-0,80
460800	+2,08
921600	-3,68

APPLICATION EXAMPLES

RS232 V24 - CONNECTION TO A PC

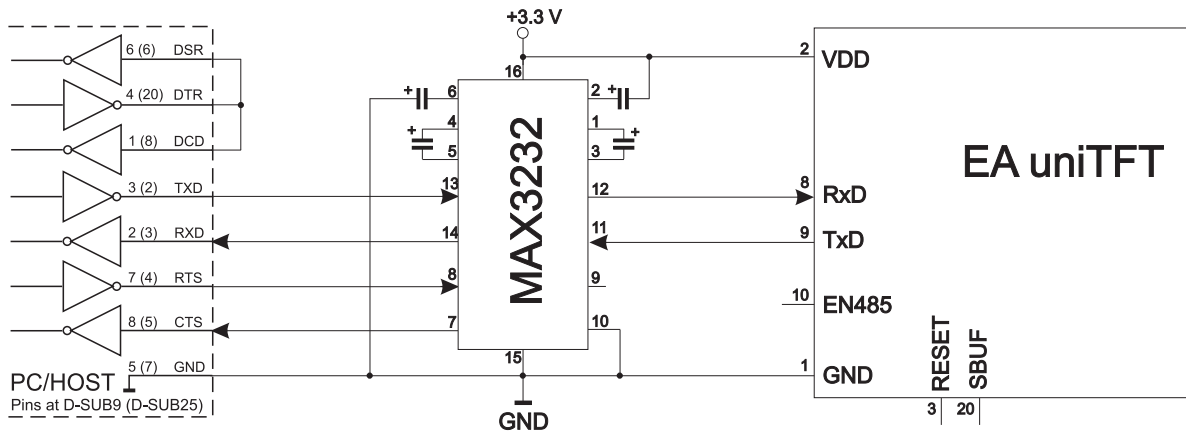

RS485 - BUS SYSTEM

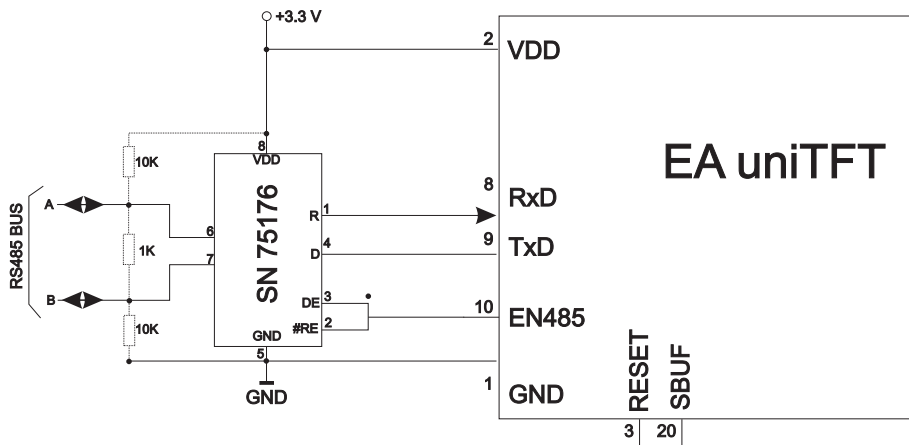

SPI

Das **S**erial **P**eripheral **I**nterface is a bus system for a serial synchronous data transmission between various ICs. The bus consists of the following lines:

- MOSI (**M**aster **O**ut → **S**lave **I**n) otherwise known as SDO (Serial Data Out) or DO
- MISO (**M**aster **I**n ← **S**lave **O**ut) also known as SDI (Serial Data In) or DI
- SCK (**S**erial **C**lock) - shift clock
- SS (**S**lave **S**elect → Addressing the partner), also known as CS (Chip Select)

SPI works with a bidirectional transmission principle, i.e. data is exchanged between the partners simultaneously. Every communication is determined by the master with the aid of the SCK line. The display works in the slave mode.

The log for the data transmission is not laid down with SPI, so that there are various configuration options. These are laid down by the parameters of clock polarity, clock phase and data order:

The SPI-Mode 3 with DORD=0 is preset. The command [Beispiel siehe S. 97](#) can change the modes 0..3. Alternatively you can set this command also in the file <start.emc>.

	CPO- L Mo- de	CPH- A (Clo- ck Pola- rity)	DORD(0) MSB first	DORD(1) LSB first
0	Low (0)	steigende Flanke (0)	<p>SPI-Mode: 0 CPOL=0 (CLK idle state LOW) CPHA=0 (data valid at first edge) DORD=0 (MSB=send BIT7 first)</p>	<p>SPI-Mode: 0 CPOL=0 (CLK idle state LOW) CPHA=0 (data valid at first edge) DORD=1 (LSB=send BIT0 first)</p>
1	Low (0)	fallende Flanke (1)	<p>SPI-Mode: 1 CPOL=0 (CLK idle state LOW) CPHA=1 (data valid at second edge) DORD=0 (MSB=send BIT7 first)</p>	<p>SPI-Mode: 1 CPOL=0 (CLK idle state LOW) CPHA=1 (data valid at second edge) DORD=1 (LSB=send BIT0 first)</p>
2	High (1)	fallende Flanke (0)	<p>SPI-Mode: 2 CPOL=1 (CLK idle state HIGH) CPHA=0 (data valid at first edge) DORD=0 (MSB=send BIT7 first)</p>	<p>SPI-Mode: 2 CPOL=1 (CLK idle state HIGH) CPHA=0 (data valid at first edge) DORD=1 (LSB=send BIT0 first)</p>
3	High (1)	steigende Flanke (1)	<p>SPI-Mode: 3 CPOL=1 (CLK idle state HIGH) CPHA=1 (data valid at second edge) DORD=0 (MSB=send BIT7 first)</p>	<p>SPI-Mode: 3 CPOL=1 (CLK idle state HIGH) CPHA=1 (data valid at second edge) DORD=1 (LSB=send BIT0 first)</p>

I²C

I²C stands Inter-Integrated Circuit and is a serial data bus developed by Phillips. The bus designed as a master-slave bus requires 2 signal lines:

- SCL (Serial Clock Line)
- SDA (Serial Data Line)

The electrical specification provides that both lines are terminated with a pull-up resistor to VDD, since all devices connected to the bus have open-collector outputs. The bus clock is always specified by the master, which determines the entire communication:

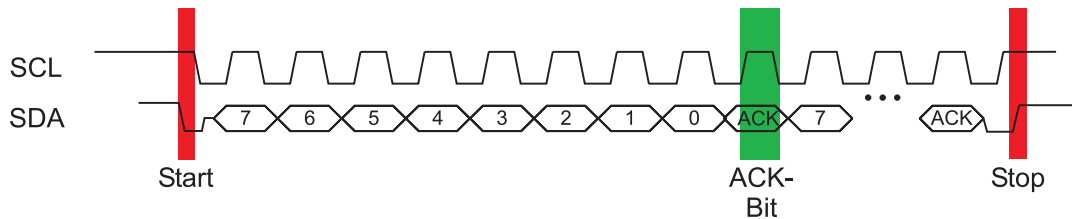

After the start condition, the slave address always follows in the transmission protocol. Bit 0 is the so-called R/W bit and determines whether the slave should read (1) or transmit data (0). The data is exchanged until the master executes the stop condition. More detailed information can be found in the I²C specification. The display operates in slave mode.

The default I²C bus address is 0xDE (depending on the notation, 0x6F). The command [Beispiel siehe S. 97](#) can be used to re-define an x-like other address. Alternatively, this can be done via the <start.emc> file.

USB

Der **U**niversal **S**erial **B**us is a serial bus system for connecting with a computer or other device. It is based on differential data transmission. The bus topology is a strict master/slave communication (exception: "On the Go" devices). In the case of the EA uniTFT050, it is always the PC/Master which has to lead the communication. The module has a CDC device class and thus connects to the PC as a virtual serial COM interface:

Description	Value
Device class	2
USB Vendor ID	0x2DA9
USB Product ID	0x2454
Gerätebeschreibung	EA uniTFT

Um Einstellungen am Display vorzunehmen oder für erste Tests empfehlen wir die USB-Schnittstelle. Sie ist einfach anzuschließen und es müssen keine Schnittstellenparameter angepasst werden.

SD CARD

The module has a removable micro SD card (up to 32GB). The micro SD card must be formatted with FAT32.

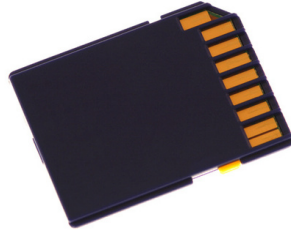

The memory is used for all project data, e.g. Different styles, objects, and images. The memory may additionally be used e.g. for data log functions at runtime.

VIDEO INPUT/CAMERA

The module has an analogue video input and supports three colour systems: **PAL** (**P**hase **A**lternating **L**ine), **Secam** (**S**équentiel couleur à mémoire) and **NTSC** (**N**ational **T**elevision **S**ystems **C**ommittee). The module automatically selects the right colour system settings.

Most digital cameras and video cameras come with a suitable interface, just as most CMOS cameras do. The resolution is limited to 720x576 (PAL and SECAM), 640x480 (NTSC) pixels. The input is also referred to as a composite video signal input.

he two connections (gold-plated solder pads) are located next to pin 27 ([see Dimensions](#)). The input levels are 3.3V compatible.

ANALOGUE INPUT

The module has 4 analog inputs with a resolution of 12 bits. The values can be used for further processing. The crossing or subtraction of a boundary region can also trigger an alarm.

Measuring range: 0V to 3.3 V. The supply voltage is used as reference input for the ADC.

PULSE WIDTH MODULATION (PWM)

The module has the possibility to control external components via a PWM signal (pulse width modulation). The duty ratio of the rectangular pulse is changed at a constant frequency (adjustable from 2 Hz to 1 MHz with the command [Beispiel siehe S. 91](#)). The duty ratio between on / off time can be changed, too. Electromechanical components, e.g. Motors or a quasi-analog voltage can be driven and generated. The variation of the duty cycle then ensures low motor speed / voltage with a short on-time or a high motor speed / voltage with a long on-time. The output levels are 0V and 3.3V.

INPUT/OUTPUT (I/O)

The module has 16 digital I/O's build in.

The input voltage range is between 0..3,3V. All 16 I/O's are configured as 100kOhm Weak Pull-up at start up.

Through the use of one or more external port-expanders MCP23017 (16 I/O for each IC) the number of the entire I/O can be extended up to 128-3. For this purpose, the ports "I/O 1.5 to 1.7" (pin 27 to 29) are switched over and used as serial data lines for the Portexpanders (see application example). This is done by soldering 3 resistors:

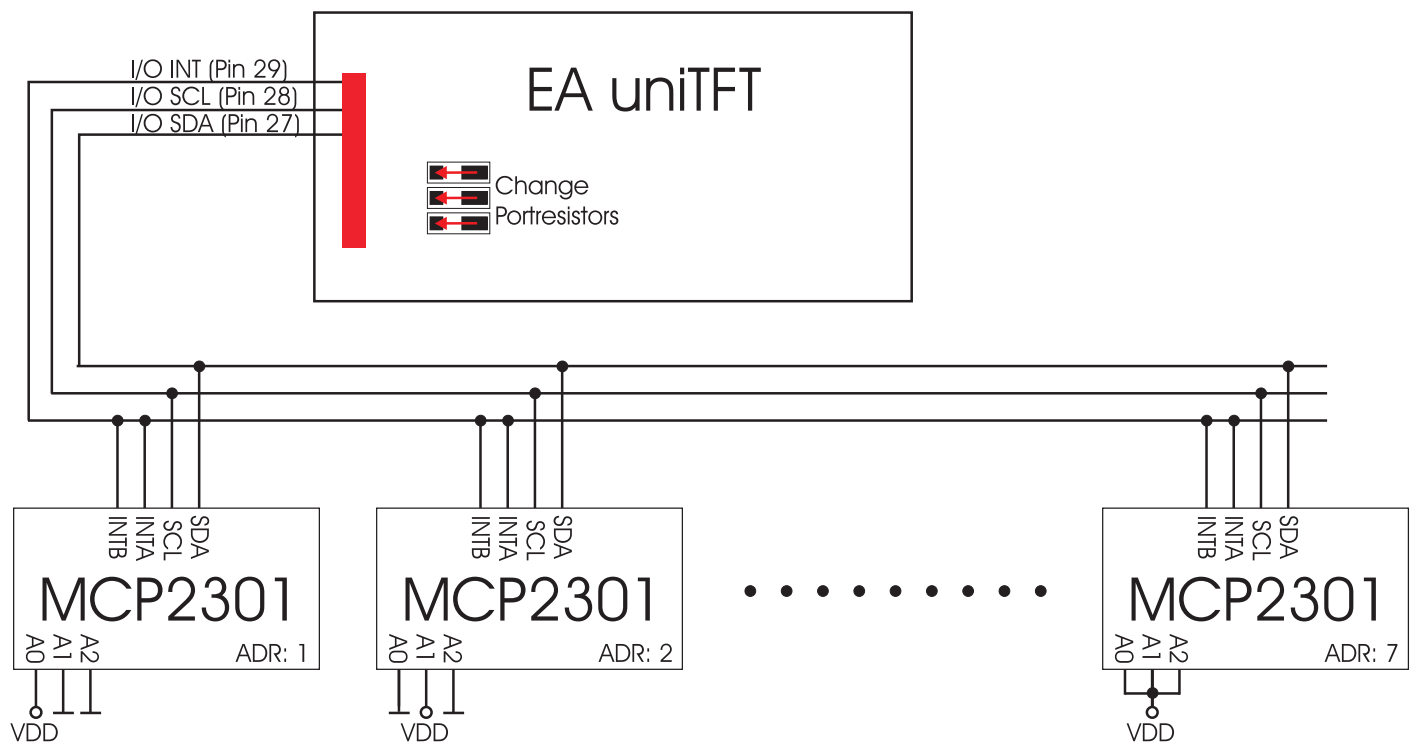

The maximum output of the component is 700mW. The maximum current load for a single pin is 25mA.

SHORT PROTOCOL & SMALL PROTOCOL

In order to ensure secure data transmission, 2 differently complex transmission protocols are integrated. In both protocols, the user data is embedded into a packet by adding a start and a final sequence. We recommend to use the short protocol, but for compatibility with the EA eDIPxxx series you can continue with the small protocol.

For initial tests on the serial interface, the protocol can also be switched off completely (Pin 22 "DPROT" to low).

Both protocols are independent of the interface RS-232, SPI, I²C or USB used. The data transmission is embedded in a fixed frame with checksum. The module acknowledges this package with the character <ACK> (= \$ 06) on successful reception or <NAK> (= \$ 15) if the checksum is incorrect or receive buffer is overflowed. In either case, after received <NAK> the complete package is discarded and must be sent again.

Note: The <ACK> must be actively read SPI and I²C). If the host does not receive an acknowledgment, at least one byte has been lost. In this case, the timeout time must be waited before the packet is completely repeated. The number (len) of the user data per packet can be max.2042 Byte. Commands larger than 2042 byte (for example, images or file #FWD ...) must be split into several packages. The user data in the individual packets are reassembled after correct reception

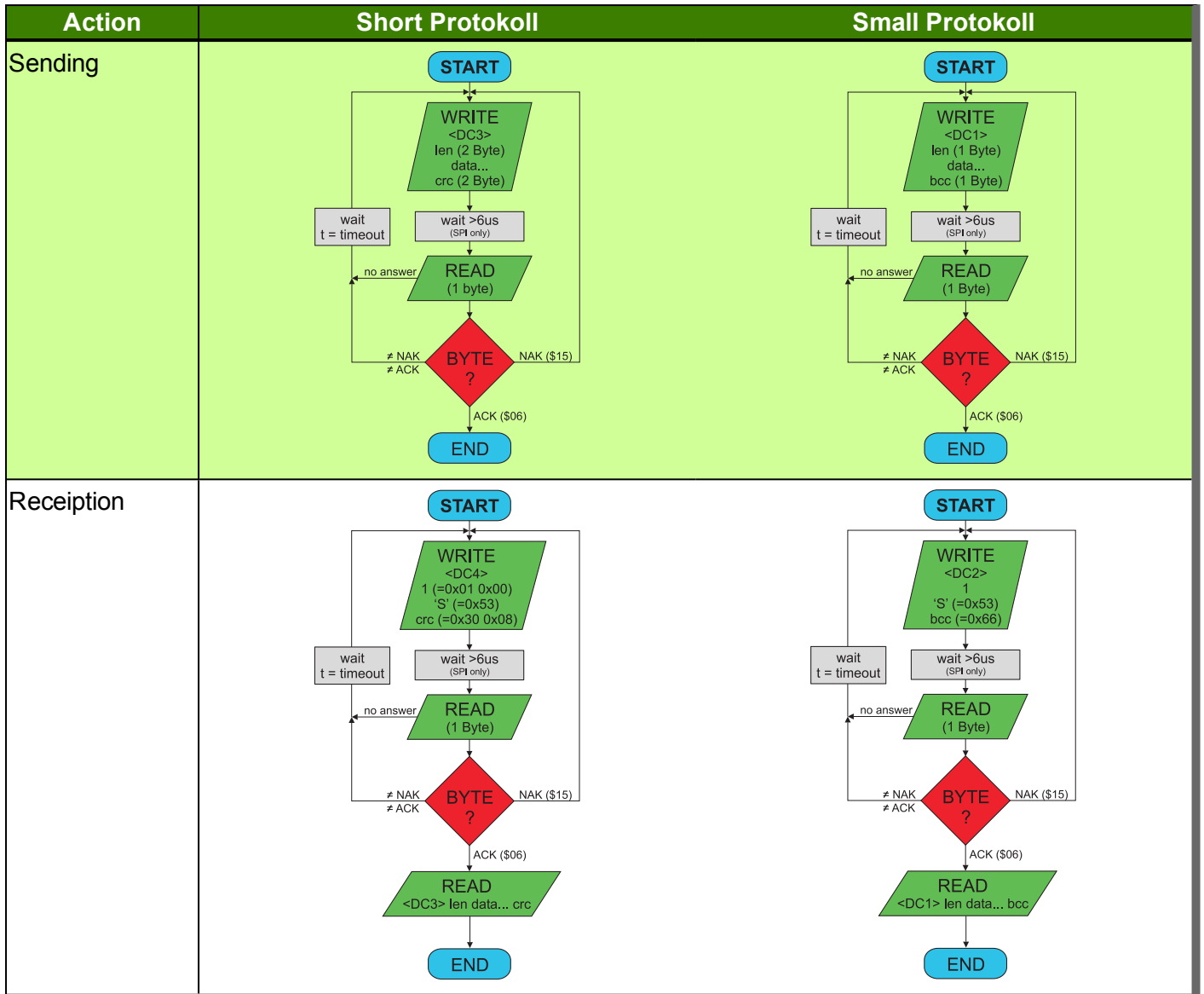

SHORT PROTOCOL

Command	Display	Byte										
		0	1	2	3	4	5	6	7	8	9	10
Send commands / data to display	send	DC3 ¹	len ²		data	crc16 ³				
	receive	ACK										
Repeat last packet	send	DC4	1	0	'S'	crc16						
	send	ACK										
	receive	DC3	len		data	crc16				
Request protocol information	send	DC4	1	0	'R'	crc16						
	send	ACK										
	receive	DC3	len		data	crc16				
Request / Release interface	send	DC4	5	0	'D'	packet size sendbuffer ⁴		timeout ⁵ [10 ms]		crc16		
	receive	ACK										
Hardware Reset / Reboot	send	DC4	1	0	'I'	crc16						
	send	ACK										
	receive	DC4	4	0	Sendbuffer bytes ready		Receivebuffer bytes free		crc16			
Repeat last packet	send	DC4	1	0	'P'	crc16						
	send	ACK										
	receive	DC4	6	0	max. Packet size		akt. Packetsize		timeout [10 ms]		crc16	
Request protocol information	send	DC4	3	0	'A'	Select / Deselect	adr	crc16				
	receive	ACK										
RS485 direction enable delay	send	DC4	2	0	'T'	Verzögerung [10 us] ⁶						
	receive	ACK										
Break-command	send	DC4	2	0	'G'	0=Freigabe 1=Anfordern	crc16					
	send	ACK										
	receive	DC4	1	0	aktiv ⁷	crc16						
Call the display's send buffer	send	DC4	2	0	'C'	mask ⁸		crc16				
	receive	ACK										
Protocol settings	Display	DC4	2	0	'B'	option ⁹		crc16				

¹DC3 = 19d = 0x13; DC4 = 20d = 0x14

²len: number of use data, without checksum, without DC3/4. Consists of 2 bytes, low byte is transmitted first

EA uniTFT Vorläufig

³crc: Checksum over all transmitted bytes, including DC3/4 and length bytes. CRC16-CCITT's start value is 0xFFFF. Low byte is transmitted first

⁴Maximum buffer size is 2042

⁵Delay in [10ms] till deletion of data packet. The default is 200 = 2 seconds.

⁶Delay in [10us] till EA uniTFT RS485-direction is altered. Default is 0 = immediately.

⁷active: 0=ALLE, 1=RS232, 2=SPI, 3=I²C, 4=USB

⁸mask: 1=break wait-command (#XXW), 2=actual macros, 4=Clear send buffer, 8=Clear receive buffer. The individual bits can be OR-combined.

⁹option: 1=Testmode, 2=Disable PowerOnMacro, 3=Disable defaults 4=Boot menu

SMALL PROTOCOLL

Command	Display	Byte					
		0	1	2	3	4	5
Send commands / data to display	receive	DC1 ¹	len ²	data	bcc ³
	send	ACK					
Call the display's send buffer	receive	DC2	1	'S'	bcc		
	send	ACK					
	send	DC1	len	data	bcc
Repeat last packet	receive	DC2	1	'R'	bcc		
	send	ACK					
	send	DC1	len	data	bcc
Protocoll settings	receive	DC2	3	'D'	packet size send-buffer ⁴	timeout ⁵ [10 ms]	bcc
	send	ACK					
Request buffer information	receive	DC2	1	'I'	bcc		
	send	ACK					
	send	DC2	2	Sendbuffer bytes ready	Receivebuffer bytes free	bcc	
Request protocoll information	receive	DC2	1	'P'	bcc		
	send	ACK					
	send	DC2	3	max. Packet size	akt. Packetsize	timeout [10 ms]	bcc
Adressing RS485	receive	DC2	3	'A'	Select / Deselect	adr	bcc
	send	ACK					
RS485 direction enable delay	receive	DC4	2	'T'	Verzögerung [10 us] ⁶		
	send	ACK					
Request / Release interface	receive	DC2	1	'G'	0=Freigabe 1=Anfordern		
	send	ACK					
	send	DC2	1	aktiv ⁷	bcc		
Break-command	receive	DC2	1	'C'	mask ⁸		
	send	ACK					
Hardware Reset / Reboot	receive	DC2	1	'B'	option ⁹	bcc	

¹DC1 = 17d = 0x11; DC2 = 18d = 0x12

²len: number of use data, without checksum, without DC1/2.

³bcc: Sum of all bytes including DC1 / 2 and length (Modulo 256)

⁴The maximum buffer size is 255

⁵Delay in [10ms] till deletion of data packet. The default is 200 = 2 seconds.

EA uniTFT Vorläufig

⁶Delay in [10us] till EA uniTFT RS485-direction is altered. Default is 0 = immediately.

⁷active: 0=ALLE, 1=RS232, 2=SPI, 3=I²C, 4=USB

⁸mask: 1=break wait-command (#XXW), 2=actual macros, 4=Clear send buffer, 8=Clear receive buffer. The individual bits can be OR-combined.

⁹option: 1=Testmode, 2=Disable PowerOnMacro, 3=Disable defaults 4=Boot menu

CHECKSUM CALCULATION

In the following two sample functions, checksum calculation for Short or Small protocol, are shown.

SHORT PROTOCOL

A cyclic redundancy check (CRC) is used to calculate the checksum. A common and well-known CRC test is the CRC-CCITT. The initial value 0xFFFF is used. The following is a typical C-implementation. The functions must be called externally. The checksum must be pre-assigned with the start value.

```
//-----  
-  
//Function: buffer2crc16()  
//input: ptr data, ptr to CRC, len  
//output: ---  
//Descr: CRC-CCITT of a buffer  
//-----  
-  
void buffer2crc16(UBYTE *dat, UINT16 *pCRC, UINT32 anz)  
{  
    while(anz--)  
        crc16(*dat++, pCRC);  
}  
  
//-----  
-  
//Function: sp_crc16()  
//input: data, ptr to CRC  
//output: ---  
//Descr: CRC_CCITT (x16+x12+x5+1 = 1 0001 0000 001>0 0001 = 0x1021  
//-----  
-  
void crc16 (UBYTE dat, volatile UINT16 * crc)  
{  
    register UINT16 lcrc = *crc;  
  
    lcrc = (lcrc >> 8) | (lcrc << 8);  
    lcrc ^= dat;  
    lcrc ^= (lcrc & 0xFF) >> 4;  
    lcrc ^= lcrc << 12;  
    lcrc ^= (lcrc & 0xFF) << 5;  
  
    *crc = lcrc;  
}
```

SMALL PROTOCOLL

For the calculation of the checksum, a simple 8-bit sum check (modulo 256) is performed for this protocol type.

```
//-----  
-  
//Function: buffer2bcc()  
//input: ptr data, len  
//output: ---  
//Descr: Byte bcc of a buffer  
//-----  
-  
UBYTE buffer2bcc(UBYTE *dat, UBYTE anz)  
{  
    UBYTE bcc = 0;  
    while(anz--)  
        bcc += *dat++;  
  
    return bcc;  
}
```

COMMANDS

COMMAND OVERVIEW

The module is controlled by a series of graphic commands. They allow the creation of a screen as a macro as well as via the serial interfaces. The following tables explain each command with the necessary and optional parameters.

TERMINAL

Parameters that are written in **GREY** in the command tables are considered optional details, and partially have default values. The default values are given in brackets behind the corresponding parameters. Parameters written in **BLACK** on the other hand, must be assigned values. Commands that may contribute towards changing parameters can only be used if the corresponding parameters have already previously been defined. Some commands allow for entering several object IDs. Should these objects be in numerical sequence, the range may be specified with the "-" sign, e.g. 1-5, instead of 1,2,3,4,5.

Designition	Command code	Description
Define window and font	#YDW PosX(old Pos), PosY(old Pos), Anchor (7), Columns(scrW()/Font width), Rows(scrH()/Font height), Font-nr(2)	Defines the terminal window through the font Font No. (1=8x8;2=8x16), number of columns Columns , number of rows Rows , position PosX , PosY and anchor Anchor . After performing the reset, the position in the lower left corner is (0,0), the anchor stands at 7. Should the position not be additionally specified when the window is re-defined, the latter is retained. Beispiel siehe S. 121
Set colour	#YDC Text- RGB , Text-Opacity(100), Background- RGB (0x00000000), Background-Opacity(0)	Defines the colour of the terminal window in regard to colour and transparency of text Text RGB (e.g. \$FF0000 for red Text Opacity and background Background RGB , Background Opacity . Beispiel siehe S. 121
Terminal level	#YDL Layer	Select the terminal layer, Select the terminal layer, Layer (0= Behind; 1= In front) (0= Behind; 1= In front)
Terminal on/off	#YDO On/Off, Visibility (=On/Off)	The parameter On/Off (0=Off; 1=On) determines whether the terminal window is switched on or off. In the switched-on state, the output is saved, however may be hidden through Visibility (0= Invisible; 1= Visible), as well as made visible again, if required.
Cursors blink on/off	#YCB Cursor	Determine the blinking of the cursor. Cursor 0=off; 1=on
Position cursor	#YCP Column, Row(keine Änderung)	Positions the cursor of the terminal window based on the column Column , and row Row .
Save cursor position	#YCS	Speichert die aktuelle Cursorposition.
Restore cursor position	#YCR	Restores the cursor position saved.

Designation	Command code	Description
Display string	#YPA 'String'	Displays the character string ' String ' in the terminal window. This command may, for example, be used in the output of the Stringregister .
Clear terminal	0x12(FF, Formfeed)	Clears the terminal and puts the cursor in the top left corner.
Show time/date	#YPD DateFormat(#WDF), Date32(actual time)	Displays the time in the terminal window. The display can be changed through the date format DateFormat, as well as its content be overwritten by changing the time and the date Date32 . Information on DateFormat can be found here .
Display string in a formatted manner	#YPF Formatstring, Value1...	Displays a formatted character string. The formatted string specifies the character string. The values are subsequently specified through (multiple) Value(s) . Information on the formatted string can be found here .
Display configuration	#YPI	Displaying the display parameters, such as the width and height, as well as interface settings in the terminal.
Display version string	#YPV	This emits the current version of the display.

IMAGES/VECTOR GRAPHICS

The module internally uses a special image format (*.epg). The conversion needs to be done externally. The Windows program EA uniSketch offers the most comfortable option to have most image formats converted. Some [commands](#) make it possible to save the screen content on the SD card or transfer image data directly via the serial interface. Various [image formats](#) are available here.

Image size

Should the width **Width** OR the height **Height**, be specified by 0, then this size is adjusted proportionally.

Should the width **Width** AND the height **Height**, be specified by 0, the image is then generated in the original size (in pixels).

ADD IMAGE/VECTOR GRAPHIC.

Parameters that are written in **GREY** in the command tables are considered optional details, and partially have default values. The default values are given in brackets behind the corresponding parameters. Parameters written in **BLACK** on the other hand, must be assigned values. Commands that may contribute towards changing parameters can only be used if the corresponding parameters have already previously been defined. Some commands allow for entering several object IDs. Should these objects be in numerical sequence, the range may be specified with the "-" sign, e.g. 1-5, instead of 1,2,3,4,5.

Designation	Command code	Description
Place image	#PPP Object-id, 'Picturename', PosX, PosY, Anchor(1), Width(0), Height(0), Angle(0)	Defines as an object Object-id , the image file ' Picturename ' and places it independently of the position PosX , PosY , the anchor Anchor (0...9), the image width Width (Pixel), the image height, Height (Pixel) and the angle Angle (0...360). Attention must be paid to whether the image file is named in upper or lower case letters. Beispiel siehe S. 110
Change image animation	#PPA Object-id, AnimationType (0), Time, Image No	Changes, in the object, Object ID , the present animation through the choice of the new animation type AnimationType . The expiration time, Time , (hrs) and the end image, Image No. , are only relevant for the animation type Animation Type = 7. This involves the time in which animation is carried out up to the image number set being defined. The prerequisites for animations are described here Beispiel siehe S. 110
Show video input	#PVP Object-id, PosX, PosY, Anchor(1), Width(0), Height(0), Angle(0)	Defines the image of the video input as Object ID, and places it, depending upon the position PosX, PosY, of the anchor Anchor (0...9), the image width Width (in pixels), the image height Height , (in pixels) and the angle Angle (0...360). Beispiel siehe S. 110

TYPES OF ANIMATION

Animations relate to objects of the type of origin **.GIF** or animated gradients.

Designation	Parameter	Description
Stop	0	Defines an animation end.
Cyclical	1	Defines a cyclical animation.
Cyclical, backwards	2	Defines a cyclical animation moving in the opposite direction.
Oscillating	3	Defines an oscillating animation.
Oscillating, backwards	4	Defines an oscillating animation moving in the opposite direction.
One-off	5	Defines a one-off animation.
Once, backwards	6	Defines a one-off animation moving in the opposite direction.
Once, in a fragmented manner	7	Defines an animation section.

STYLE SHEETS

Allgemeine Informationen zu den Styles befinden sich [hier](#).

Parameters that are written in **GREY** in the command tables are considered optional details, and partially have default values. The default values are given in brackets behind the corresponding parameters. Parameters written in **BLACK** on the other hand, must be assigned values. Commands that may contribute towards changing parameters can only be used if the corresponding parameters have already previously been defined. Some commands allow for entering several object IDs. Should these objects be in numerical sequence, the range may be specified with the "-" sign, e.g. 1-5, instead of 1,2,3,4,5.

COLOUR GRADIENTS AND LINE PATTERNS

Designation	Command code	Description
Define colour gradient	#CCR Ramp-nr, Offset, RGB, Opacity, reapeate all parameters	Defines a colour gradient Ramp No. (1...255) with the RGB colours (e.g. \$FF0000 for red) and associated transparency Opacity0 ...100). The offset Offset (0...100) determines at what point, as a percentage, the next colour is to be found. A maximum of 10 supporting points can be defined in a colour gradient. Beispiel siehe S. 117
Animate colour gradient	#CAC Ramp-nr, AnimationType(1), Time (100)	Animates the colour gradient Ramp No. with the animation type AnimationType (1...7) over the time period Time (hrs). Animation types
Define dash patterns	#CDP Dash-nr, Dashphase, Dash, Space, Dash, Space ...	Defines a dash pattern Dash No. (1...10), depending upon the length of the dash Dash (in pixels) and length of clearance Space (in pixels). The offset Dash Phase (0...100) determines, as a percentage, the starting point from which the dash pattern is drawn. A maximum of 10 combinations for line length and clearance may be defined in a dash pattern. Beispiel siehe S. 117
Animate dash patterns	#CAD Dash-nr, AnimationType(1), Time(100)	Animates the dash pattern Dash No. with the animation type AnimationType (1...7) over the time period Time (hrs).. Animation types

DRAWING STYLE

Designation	Command code	Description
No filling	#CFD Drawstyle-nr	Defines a Drawing Style Number without a filling. The filling is thus transparent.

Designation	Command code	Description
Define filling colour	#CFC Drawstyle-nr, RGB, Opacity(100)	Defines a drawing style Drawing Style No. with a plain colour filling RGB (e.g. \$FF0000 for red), as well as its transparency Opacity (0...100). Beispiel siehe S. 118
Linear colour gradient	#CFL Drawstyle-nr, Ramp-nr, Angle(0)	Defines a drawing style Drawing Style No. with linear colour gradient Ramp No. and its Angle (0...360). In order to be able to use this command, it is necessary to define a colour gradient in advance. Beispiel siehe S. 118
Radial colour gradient	#CFR Drawstyle-nr, Ramp-nr, FocusX (5000), FocusY(0)	Defines a drawing style Drawing Style No. with a radial colour gradient Ramp No. The focal position FocusX,Y (0...100) defines, as a percentage, the starting point of the gradient. Should the focal point FocusX be specified as being a number of pixels that is greater than 5,000, then FocusY can be set as an anchor. In order to be able to use this command, it is necessary to define a colour gradient in advance. Beispiel siehe S. 118
Conical colour gradient	#CFK Drawstyle-nr, Ramp-nr, FocusX (5000), FocusY(0), Direction	Defines a drawing style Drawing Style No. with a conical colour gradient Ramp No. The focal position FocusX,Y (0...100) defines, as a percentage, the starting point of the gradient. The direction of movement Direction (0= Anti-clockwise; 1= Clockwise) determines the orientation. Should the focal point FocusX be specified as being a number of pixels that is greater than 5,000, then FocusY can be set as an anchor . In order to be able to use this command, it is necessary to define a colour gradient in advance. Beispiel siehe S. 118

Designation	Command code	Description
Filling with a pattern	#CFP Drawstyle-nr, 'Patternname', Size(0), Angle(0), Repeat/Reflekt(0), FocusX (5000), FocusY(0), AnchorP(5)	Defines a Drawing Style No. with a pattern ' Pattern name ' that depends upon the Size (proportional), the Angle (0...360) and the representation Repeat/Reflect (Repeat= 0; Reflect= 1). The focal position FocusX,Y (0...100) defines, as a percentage, the starting point of the gradient. Should the focal point FocusX be specified as being a number of pixels that is greater than 5,000, then FocusY can be set as an anchor Anchor . The pattern anchor AnchorP (0...9) sets the reference point of the pattern. Beispiel siehe S. 119
Change angle of the colour gradient	#CFA Drawstyle-nr, Angle	Changes the colour gradient angle Angle of the drawing style Drawing Style No. .
Change colour gradient	#CFG Drawstyle-nr, Ramp-nr,	Changes the colour gradient Ramp No. of the drawing style Drawing Style No. . In order to be able to use this command, it is necessary to define a colour gradient in advance.
Change focus of the filling	#CFF Drawstyle-nr, FocusX, FocusY, AnchorP(No Change)	Changes the focal position FocusX,Y of the drawing style Drawing Style No. , as well as the patternanchor AnchorP when filled with a pattern.
Change pattern	#CFN Drawstyle-nr, 'Patternname'	Changes the pattern ' Pattern name ' of the drawing style Drawing Style No. . In order to be able to use this command, it is necessary to define a pattern in advance.
Change size of pattern	#CFS Drawstyle-nr, Size	Proportionality changes the size Size of the pattern of the drawing style Drawing Style No. .
Change representation of pattern	#CFT Drawstyle-nr, Repeat/Reflect	Changes the Repeat/Reflect representation of the filling pattern of the drawing style Drawing Style No. .

LINE STYLE

Designation	Command code	Description
Refrain from defining a line	#CLD Drawstyle-nr	Defines a Drawing Style No. without a line style. The line thus becomes invisible.

Designation	Command code	Description
Define line style	#CLS Drawstyle-nr, RGB, Opacity(100), Width(1), Joint(0), Dash-nr(0)	Defines a drawing style Drawing Style No. with a border, depending upon its RGB colour (e.g. \$FF0000 for red), transparency Opacity (0..100), width Width (in pixels), rounding off Joint (Angular = 0; Round = 1) and dash pattern Dash No. . To use the dash pattern, the latter needs to have been pre-defined. Example
Change line colour	#CLC Drawstyle-nr, RGB, Opacity(No Change)	Changes the RGB colour (e.g. \$FF0000 for red) and transparency Opacity (0..100) of the drawing style Drawing Style No. . In order to be able to use this command, it is necessary to define a colour in advance.
Change line width	#CLW Drawstyle-nr, Width	Changes the Width of the line of the drawing style Drawing Style No. .
Change line end	#CLE Drawstyle-nr, Joint	Changes the line rounding off Joint (Angular = 0; Round = 1) of the line of the drawing style Drawing Style No. . Beispiel siehe S. 119
Change line pattern	#CLP Drawstyle-nr, Dash-nr	Changes the colour gradient Dash No. of the drawing style Drawing Style No. . In order to be able to use this dash pattern, it is necessary to define it in advance

TEXT STYLE

Designation	Command code	Description
Define text style	#CTF Textstyle-nr, 'Fontname', Size(20 *.evf / 0 *.epf), Align(0), Drawstyle-nr(1), Italic(0), SpaceL(0), SpaceC(0)	Defines a text style Text Style No. with a font ' Font Name ' which depends upon the latter's size Size , orientation Align (0=On the left; 1=Centred; 2=On the right), drawing style Drawing Style No. , italic angle Italic (-45°...45°), line spacing SpaceL (in pixels) and character pitch SpaceC (in pixels). In order to be able to use this command, it is necessary to define a drawing style style in advance. For performance reasons, it is recommended to refrain from using an outline(#CLD). Beispiel siehe S. 119
Change font	#CTN Textstyle-nr, 'Fontname'	Changes the font ' Font Name ' of the text style Text Style No. .
Change text size	#CTS Textstyle-nr, Size	Changes the size Size of the text style Text Style No. .

Designation	Command code	Description
Change text orientation	#CTA Textstyle-nr, Align	Changes the orientation Align (0=On the left; 1=Centred; 2=On the right) of the text style Text Style No. .
Change text character style	#CTC Textstyle-nr, Drawstyle-nr	Changes the drawing style Drawing Style No. of the text style Text Style No. .
Change text slant	#CTI Textstyle-nr, Italic	Changes the italic angle Italic of the text style Text Style No. .
Change spacing between characters	#CTG Textstyle-nr, Spacel, SpaceC(No Change)	Changes the line spacing Spacel and character pitch SpaceC of the text style Text Style No. . Negative spacing and/or pitch is also possible.

TOUCH BUTTON STYLE

Designation	Command code	Description
Image for touch button	#CBP Buttonstyle-nr, 'Buttonname'normal, 'Buttonname'down(normal), SizeX(0), SizeY(0)	Defines a button style Button Style No. with an image for the unpressed state ' Button Name' (normal) and pressed state ' Button name' (down), depending upon the image size SizeX , SizeY (in pixels). Beispiel siehe S. 120
Touch button drawing style	#CBD Buttonstyle-nr, 'Drawstyle-nr'normal, 'Drawstyle-nr'down(normal), Width, Height, Radius	Defines a button style Button Style No. with a drawing style for the unpressed state Drawing Style No.(normal) , drawing style for the pressed state Drawing Style No.(down) , button width Width (in pixels), button height Height (in pixels) and corner radius Radius (in pixels). In order to be able to use this command, it is necessary to define a drawing style style in advance. Beispiel siehe S. 120
Text style of touch button	#CBT Buttonstyle-nr, 'Textstyle-nr'normal, 'Textstyle-nr'down, OffsetX, OffsetY	Defines a button style Button Style No. with text style for the unpressed state Text Style No.(normal) , text style for the pressed state Text Style No.(down) and a text offset OffsetX , OffsetY (in pixels)..
Change the proportion of the touch button when pressed	#CBO Buttonstyle-nr, OffsetX(0), OffsetY(OffsetX), Size(0), Angle(0)	Defines a button style Button Style No. for the pressed state with an offset OffsetX , OffsetY (in pixels), change in size Size (proportional) and change in the angle Angle (0...360). Beispiel siehe S. 120

Designation	Command code	Description
Touch button disabled	#CBG Buttonstyle-nr, DisableR(-30), DisableG(DisableR), DisableB(DisableR)	Defines a deactivated/greyed out button style Button Style No. , depending upon a subtraction of the colour portions red DisableR (-100...0), green DisableG (-100...0)and blue DisableB (-100...0).
Sound relating to touch button	#CBS Buttonstyle-nr, 'Soundname'(alten löschen)	Defines a sound in the button style Button Style No. with the audio file " Sound Name ". Should no audio file be specified, then the old sound will be deleted. Should a 0 be specified for button style, then the standard sound is selected.

DRAWING/GRAPHIC PRIMITIVES

Parameters that are written in **GREY** in the command tables are considered optional details, and partially have default values. The default values are given in brackets behind the corresponding parameters. Parameters written in **BLACK** on the other hand, must be assigned values. Commands that may contribute towards changing parameters can only be used if the corresponding parameters have already previously been defined. Some commands allow for entering several object IDs. Should these objects be in numerical sequence, the range may be specified with the "-" sign, e.g. 1-5, instead of 1,2,3,4,5.

Designation	Command code	Description
Rectangle	#GRR Object-id, Drawstyle-nr, PosX, PosY, Anchor, Width, Height(same as Width), Radius(0), BorderWidth(0), Angle(0)	Defines as an object Object ID a rectangle, depending upon the drawing style Drawing Style No. , the position PosX , PosY , the anchor Anchor , (0...9), the width Width (in pixels), the height Height (in pixels), the radius for the corners Radius (in pixels), the border width BorderWidth , (0...100) and the angle Angle (0...360). In order to be able to use this command, it is necessary to define a drawing style in advance. Example
Draw polyline	#GPL Object-id, Drawstyle-nr, PosX, PosY, PosX2, PosY2, PosX3, PosY3, ...	Defines as an object, Object ID a polyline, depending upon the drawing style, Drawing Style No. and the corresponding position points PosX , PosY . To use the command, a drawing style needs to have been defined in advance. Beispiel siehe S. 124
Polygon(filled in)	#GPF Object-id, Drawstyle-nr, PosX, PosY, PosX2, PosY2, PosX3, PosY3, ..., autoclose polygon	Defines as an object, Object ID a filled-in polygon, depending upon the drawing style, Drawing Style No. and the position points PosX , PosY . To use the command, a drawing style needs to have been defined in advance. The polygon is automatically concluded after the last position value. Beispiel siehe S. 124
Extend a polyline/polygon	#GPA Object-id, PosX, PosY, PosX2, PosY2, ...	Adds additional positions PosX , PosY to the object, Object ID , of #GPF and #GPL . Beispiel siehe S. 124
Polypath segment	#GPP Object-id, Drawstyle-nr, PosX, PosY, Segment1, Segment2, ...	Defines as an object, Object ID a filled-in polygon, depending upon the drawing style, Drawing Style No. , the position points, PosX , PosY and the individual segments Segment . These also allow for having round shapes. To use the command, a drawing style needs to have been defined in advance. Beispiel siehe S. 125

Designation	Command code	Description
Polygon(geometric)	#GPP Object-id, Drawstyle-nr, PosX, PosY, Anchor, Radius, NumberCorners, BorderWidth(0), Angle(0)	Defines as an object Object ID a polygon, depending upon the drawing style Drawing Style No. , the position points, PosX , PosY , the anchor , Anchor(0...9) , of the radius Radius (in pixels), the number of corners NumberCorners , the border width Border Width (0...100) and the angle Angle (0...360). To use the command, a drawing style needs to have been defined in advance. Beispiel siehe S. 125
Polygon(star)	#GGS Object-id, Drawstyle-nr, PosX, PosY, Anchor, Radius1, Radius2, CountPoints, BorderWidth(0), Angle(0)	Defines as an object Object ID a star-shaped polygon, depending upon the drawing style Drawing Style No. , the position points PosX , PosY , the anchor Anchor (0...9), the external radius Radius1 (in pixels), the internal radius Radius2 (in pixels), the number of points CountPoints , the border width Border Width (0...100) and the angle Angle (0...360). To use the command, a drawing style needs to have been defined in advance. Beispiel siehe S. 125
Circle/ellipse	#GET Object-id, Drawstyle-nr, PosX, PosY, Anchor, Radius1, Radius2(Radius1), BorderWidth(0), Angle(0)	Defines as an object Object ID a circular or elliptical polygon, depending upon the drawing style Drawing Style No. , the position points, PosX , PosY , the anchor Anchor (0...9), the external radius Radius1 (in pixels), the internal radius Radius2 , the border width Border Width (0...100) and the angle Angle (0...360). To use the command, a drawing style needs to have been defined in advance. Beispiel siehe S. 126
Arc of a circle	#GEA Object-id, Drawstyle-nr, PosX, PosY, Anchor, Radius1, Radius2(Radius1), StartAngle(0), StopAngle(360), BorderWidth(0), Angle(0)	Defines as an object Object ID a curved polygon, depending upon the drawing style Drawing Style No. , the position points, PosX , PosY , the anchor Anchor (0...9), the external radius Radius1 (in pixel)s, the internal radius Radius2 , the starting angle Starting Angle (0...360), the stop angle Stop Angle (0...360), the border width Border Width (0...100) and the angle Angle (0...360). To use the command, a drawing style needs to have been defined in advance. Beispiel siehe S. 126

Designation	Command code	Description
Straight cut	#GES Object-id, Drawstyle-nr, PosX, PosY, Acnhor, Radius 1, Radius2(Radius1), StartAngle(0), StopAngle(360), Angle (0)	Defines as an object Object ID a cut circle, depending upon the drawing style Drawing Style No. , the position points, PosX , PosY , the anchor Anchor (0...9), the length radius Radius1 (in pixels), the height radius Radius2 , the starting angle Starting Angle (0...360), the stop angle Stop Angle (0...360), the border width Border Width (0...100) and the angle Angle (0...360). To use the command, a drawing style needs to have been defined in advance. Beispiel siehe S. 126
Section	#GEP Object-id, Drawstyle-nr, PosX, PosY, Anchor, Radius1, Radius2(Radius1), StartAngle(0), StopAngle(360), Angle (0)	Defines as an object Object ID a section of a polygon, depending upon the drawing style Drawing Style No. , the position points, PosX , PosY , the anchor Anchor (0...9), the external radius Radius1 (in pixels), the internal radius Radius2 , the starting angle Starting Angle (0...360), the stop angle Stop Angle (0...360), the border width Border Width (0...100) and the angle Angle (0...360). To use the command, a drawing style needs to have been defined in advance. Beispiel siehe S. 126

SEGMENT TYPES

General information on the segments can be found [here](#).

Designation	Parameter	Description
Horizontal line	?H, x	Defines the position x for a horizontal line point. Beispiel siehe S. 127
Vertical line	?V, y	Defines the position y for a vertical line point. Beispiel siehe S. 127
Freehand line	?L, x, y	Defines the position x, y for the next line point. Beispiel siehe S. 127
Arc of a circle	?Ct, r, x, y	Defines the position x, y for the next point of the arc, as well as its radius r (in pixels). Beispiel siehe S. 128
Elliptical arc	?Et, rx, ry, Angle, x, y	Defines the position x, y for the next point of the ellipse, as well as its radius rx, ry (in pixels) and Angle . Beispiel siehe S. 128
Quadratic Bézier curve	?Q, c1x, c1y, x, y	Defines the positions c1x, c1y , as well as x, y and for the quadratic Bézier curve. Beispiel siehe S. 128
Slight quadratic Bézier curve	?R, x, y	Defines the position x, y for an addition to the quadratic Bézier curve. Mirrors c1x and c1y of the previous segment, i.e. this command is not suitable for only one segment. Beispiel siehe S. 128
Cubic Bézier curve	?S, c1x, c1y, c2x, c2y, x, y	Defines the positions c1x, c1y and c2x, c2y , as well as x, y , for the cubic Bézier curve. Beispiel siehe S. 129
Slight cubic Bézier curve	?T, c2x, c2y, x, y	Defines the positions c2x, c2y and x, y for an addition to the cubic Bézier curve. Mirrors c1x and c1y of the previous segment, i.e. this command is not suitable for a single segment. Beispiel siehe S. 129
Close path	?Z	Defines the path end, i.e. the next point is the starting point of the first segment. Beispiel siehe S. 129
Jump (new sub-path)	?M x, y	Defines a new starting point for the subsequent segment. Beispiel siehe S. 129

STRINGS AND CHARACTER STRING COMMANDS

Parameters that are written in **GREY** in the command tables are considered optional details, and partially have default values. The default values are given in brackets behind the corresponding parameters. Parameters written in **BLACK** on the other hand, must be assigned values. Commands that may contribute towards changing parameters can only be used if the corresponding parameters have already previously been defined. Some commands allow for entering several object IDs. Should these objects be in numerical sequence, the range may be specified with the “-” sign, e.g. 1-5, instead of 1,2,3,4,5.

Designation	Command code	Description
Place character string	#SSP Object-id, Textstyle-nr, PosX, PosY, Anchor, 'String'	Defines as an object Object ID a ' String ' and places it, depending upon the text style Text Style No. , the position PosX , PosY and the anchor Anchor . Beispiel siehe S. 115
Change character string	#SSC Object-id, String	Changes the string allocated in the object Object ID into a new string ' String '.
Place formatted character string	#SFP Object-id, Textstyle-nr, PosX, PosY, Anchor, 'Formatstring'; Value1...	Defines as an object Object ID a ' Format String ' and places it, depending upon the text style Text Style No. , the position PosX , PosY and the anchor Anchor . The content of the string is, among other things, determined by the successive values Value . Beispiel siehe S. 115
Change formatted character string	#SFC Object-id, Value1...	Changes the value Value of the formatted string of the object Object ID .
Place calculation string (auto update)	#SAP Object-id, Textstyle-nr, PosX, PosY, Anchor, 'Formatstring'; Value1(Calculation), Value2	Defines as an object Object ID a 'Format String' and places it, depending upon the text style Text Style No. , the position PosX , PosY and the anchor Anchor . The content of the string is, among other things, determined by the successive calculated values Value . In the event of the calculation of the first value being amended Value1 , the display is renewed. Beispiel siehe S. 115
Change auto update of the calculation string.	#SAC Object-id, (ChangeCalculation)	Updates the update calculation ChangeCalculation for the automatic display in the object Object ID . The calculation of the values of the calculation string is, in that respect, not changed. The changed calculation always has the Integer data type. Beispiel siehe S. 115

Designation	Command code	Description
Place date/time string	#SDP Object-id, Textstyle-nr, PosX, PosY, Anchor, DateFormat (Date), Date32 (actual time)	Defines as an object Object ID a string and places it, depending upon the text style Text Style No. , the position PosX, PosY and the anchor Anchor . The content of the string is determined by the choice of date format DateFormat(#WDF) , the current time and the current date Date32 . The time is updated automatically. The last optional parameter Date32 can be specified unless the current time is supposed to be displayed.
Change date/time string	#SDC Object-id, Date32(actual time)	Changes the time or date specification Date32 of the time string Object ID .

EDIT BOX

The edit box is an editable box for strings. The latter is used, for example, in combination with the keyboard. The default string is the first visible display of the edit box, and exists once the corresponding function is accessed.

Designation	Command code	Description
Place edit box for strings	#SEP Object-id, Drawstyle-nr, PosX, PosY, Anchor Width, Height, Radius, Textstyle, OffsetX, OffsetY	Defines as an object Object ID an editable string box, and places it, depending upon the drawing style Text Style No. , the position PosX, PosY and the anchor Anchor . The width Width , height Height , rounding of the corners Radius , text style Text Style distance from the lateral edge OffsetX and offset in the Y direction OffsetY likewise need to be specified for the creation. Beispiel siehe S. 115
Send default string to edit box	#SED Object-id, Strings...	Defines, as an object Object ID , a default string String , and transmits it to the edit box.
Send code/string to edit box	#SEC Object-id, Codes/Strings...	Defines, as an object Object ID , codes or strings String , and transmits them to the edit box.
Link keyboard to edit box	#SEK Keyboard-id, Object-id...	Links a keyboard Keyboard ID with one or more edit boxes Object ID . As a result, it is possible to edit multiple edit boxes with one keyboard Beispiel siehe S. 115

Designation	Command code	Description
Enable edit box for keyboard	#SEA Object-id	Activates an edit box Object ID for the linked keyboard. That means that one of the edit boxes allocated to the keyboard can be activated for processing. Always only one edit box is active. Object ID= 0 disables all edit boxes. Beispiel siehe S. 115

TOUCH OBJECTS / TOUCH FUNCTIOS

Two types of operation are available for touch areas:

Touch button (**B**) = Pushing, they jump into the non-pressed state as soon as the actuation is finished.

Touch switch(**S**) = Switching on, the state is changed once

Parameters that are written in **GREY** in the command tables are considered optional details, and partially have default values. The default values are given in brackets behind the corresponding parameters. Parameters written in **BLACK** on the other hand, must be assigned values. Commands that may contribute towards changing parameters can only be used if the corresponding parameters have already previously been defined. Some commands allow for entering several object IDs. Should these objects be in numerical sequence, the range may be specified with the “-” sign, e.g. 1-5, instead of 1,2,3,4,5.

DEFINITION OF TOUCH OBJECTS

Designition	Command code	Description
Rectangular touch button	#TBR Object-id, Buttonstyle-nr, 'Text'(normal), 'Text'(down), PosX, PosY, Anchor(5), Width(Buttonstyle), Height (Buttonstyle) #TSR	The touchbutton Object-id with button style Buttonstyle-nr , both strings for pressed 'Text' (normal) and unpressed Text (down) state is drawn. The width Width (Pixel) and height Height (Pixel) out of the button style is used, but you can set it individually, too. You have to define a button style before using this command. Beispiel siehe S. 122
Elliptical touch button	#TBE Object-id, Buttonstyle-nr, 'Text'(normal), 'Text'(down), PosX, PosY, Anchor (5), Width(Buttonstyle), Height (Buttonstyle) #TSE	The elliptical touch button Object-id with button style Buttonstyle-nr , both strings for pressed 'Text' (normal) and unpressed Text (down) state is drawn. The width Width (Pixel) and height Height (Pixel) out of the button style is used, but you can set it individually, too. You have to define a button style before using this command. Beispiel siehe S. 122
Touch button as an image	#TBP Object-id, Buttonstyle-nr, 'Text'(normal), 'Text'(down), PosX, PosY, Anchor (5), SizeX(Buttonstyle), SizeY (Butonstyle) #TSP	An image is used touch object Object-id . Properties are set in the button style Buttonstyle-nr . The string for unpressed 'Text' (normal) and pressed Text (down) , the position PosX , PosX need to be handed over. The anchor Anchor , width SizeX (Pixel) and height SizeY (Pixel) can be set up through the button style.können auch aus dem Buttonstyle übernommen werden. ZYou have to define a button style before using this command (#CBP). Beispiel siehe S. 122

Designation	Command code	Description
Convert Object to a touch switch / button	#TBO Object-id, Buttonstyle-nr, 'Text'(normal), 'Text'(down) #TSO	converts any object into a touchable object element Object-id . All the additional information required for creating a touch area is taken from the button style Buttonstyle-nr . The text for the unpressed 'Text'(normal) and pressed state Text(down) are handed over, too. You have to define a button style before using this command.

TOUCH FUNCTIONS

Designation	Command code	Description
Change touch status	#TCS Touchstate, Object-id ...	Changes the state Touchstate (0= pressed; 1= unpressed; 2= deactivated) of one ore more touch objects Object-id
Change touch labeling	#TCL Object-id, 'Text'(normal), 'Text'(down)	Changes the text Text(normal/down) of a touch object Object-id .
Disable/Enable Touch	#TCE State, Object-id ...	Activates (State = 1) or deactivates State = 0) one or more touch objects Object-id .
Touch responses	#TCR Signal, Filter, Object-id ...	Determination of the behavior of one or more touch subjects Object-id . Signal parameter is used to define which actions can be called 1= unpressed; 2= pressed; 3= pressed and unpressed; 4 = drag; 7 = evrything The filter Filter offers the possibility to block the transmission depending on the macro definition: 0= only send if there is no macro defined; 1 =send always
Assign a touch response to the object	#TID Mask, Object-id ...	Assignes one or more objects Object-id a touch action Mask (1= internally; 2= move; 4= resize, 8= rotate). Mask=1 is used for special touch objects, like bargraphs or indicational instruments. Mask= 2 the object is movable on the screen for the user, Mask= 4 resizing object, Mask= 8 rotates the objects around its' anchor
Check status touch switch	#TQS Object-id ...	Sends the status of the object Object-id . A more precise description of the system response can be found in the chapter Responsens. (#HAR)(#TQS)
Create radio-group	#TRA Group-id, Object-id...	Creates a new object Group-id and includes some touchbuttons Object-id , to create a radio group.

Designation	Command code	Description
Check the active switch of the radio group	#TQR Group-id ...	Sends the status of one or more radio groups Group-id . A more precise description of the system response can be found in the chapter Responsens. (#HAR) (#TQR)

BAR GRAPHS AND INSTRUMENTS

Parameters that are written in **GREY** in the command tables are considered optional details, and partially have default values. The default values are given in brackets behind the corresponding parameters. Parameters written in **BLACK** on the other hand, must be assigned values. Commands that may contribute towards changing parameters can only be used if the corresponding parameters have already previously been defined. Some commands allow for entering several object IDs. Should these objects be in numerical sequence, the range may be specified with the “-” sign, e.g. 1-5, instead of 1,2,3,4,5.

Designation	Command code	Description
Bar graph -rectangle	#IBR Object-id, Drawstyle-Front, Drawstyle-Back, PosX, PosY, Anchor, Width, Height, Radius(0), Startvalue(0), Endvalue(100), Course(1), Angle(0)	Defines a rectangular bar graph as an object Object ID , depending upon the drawing style of the foreground Drawing Style No. Front , the drawing style of the background Drawing Style Back , the position PosX, PosY , the anchor Anchor(0...9) , the width Width(Pixel) of the bar, the bar's height Height(Pixel) , the radius Radius for the corners, the Start Value , the End Value , the direction Course(0=right→ left; 1=left→ right) and the angle Angle(0...360) . Beispiel siehe S. 112
Bar graph - triangle	#IBT Object-id, Drawstyle-Front, Drawstyle-Back, PosX, PosY, Anchor, Width, Height, Tip(0), Startvalue(0), Endvalue(100), Course(1), Angle(0)	Defines a triangular bar graph as an object Object ID , depending upon the drawing style of the foreground Drawstyle Front , the drawing style of the background Drawstyle Back , the position PosX, PosY , the anchor Anchor(0...9) , the width of the bar graphs Width(in pixels) , the height of the bar graphs Height(in pixels) , the position of the tip Tip(0=Bot; 1=Top; 2=Mid) , of the start value Start Value , the end value End Value , the direction of movement Course(0=Large→small; 1=Small→large) and the angle Angle(0...360) . Beispiel siehe S. 112

Designation	Command code	Description
Bar graph - arc	#IBA Object-id, Drawstyle-Front, Drawstyle-Back, PosX, PosY, Anchor, Radius, Borderwidth, Startangle, Stopangle, Startvalue(0), Endvalue(100), Direction(1)	Defines a curved bar graph as an object Object ID , depending upon the drawing style of the foreground Drawstyle Front , the drawing style of the background Drawstyle Back , the position PosX, PosY , the anchor Anchor(0...9) , the radius to the curvature of the bar graph Radius , the height of the bar graph as a border width of the defined circle Border Width (in pixels), the starting angle Start Angle(0...360) , the end angle Stop Angle(0...360) , the starting value Start Value , the end value End Value and the direction of movement Direction(0=Anti-clockwise; 1=Clockwise) Beispiel siehe S. 112
Place instrument picture	#IPP Object-id, "Instrumentname", PosX, PosY, Anchor, Width(0), Height(0), Startvalue(0), Endvalue(100), Angle(0)	Defines as an object Object ID a rectangle, depending upon the drawing style, Drawing Style No. , the position PosX, PosY , the anchor Anchor(0...9) , the width, Width (in pixels), the height, Height (in pixels), the radius for the corners, Radius (in pixels), the border width, Border Width , (0...100) and the angle, Angle (0...360). Beispiel siehe S. 113
Define rotational instrument	#IGM Group-id, Indicator-id, Startangle, DeltaAngle, Startvalue(0), Endvalue(100)	Defines an object group Group-ID as a rotational instrument. For use, the rotating object Indicator ID , starting angle Start Angle and angle of rotation Delta Angle need to be established. Starting value Start Value and end value End Value determine the range of values. Beispiel siehe S. 112
Define slider	#IGS Group-id, Path-id, Slide-id, Turn(0), Startvalue(0), Endvalue(100)	Defines an object group Group-ID as a slider. For use, the path of the slider Path ID and sliding object Slide ID need to be established. Torsion in the case of the revolution of the path Turn is an optional detail. Starting value Start Value and end value End Value determine the range of value Beispiel siehe S. 113

Designation	Command code	Description
Set value	#IVS Object-id, Current, Time(0), ActionCurve(0)	Setzt das Instrument Object-id auf einen Wert Current . Die Animation der Werteinstellung wird durch die Dauer Time (hs) und die Aktionskurve ActionCurve (1... 10) bestimmt.
Automatically change value	#IVA Object-id, BarCalculation, Time(0), ActionCurve(0)	Sets the instrument Object ID to a value BarCalculation . The animation of the value setting is determined by the duration Time (hrs) and the action curve Action Curve (1...10). Beispiel siehe S. 113
Update calculation	#IVC Object-id, ChangeCalculation(bar calculation)	Initiates in the instrument or bar graphs Object ID a recalculation Change Calculation . The calculation is always of the "Integer" data type.

OBJECTS

Allgemeine Informationen zu den Objekten befinden sich [hier](#).

Parameters that are written in **GREY** in the command tables are considered optional details, and partially have default values. The default values are given in brackets behind the corresponding parameters. Parameters written in **BLACK** on the other hand, must be assigned values. Commands that may contribute towards changing parameters can only be used if the corresponding parameters have already previously been defined. Some commands allow for entering several object IDs. Should these objects be in numerical sequence, the range may be specified with the "-" sign, e.g. 1-5, instead of 1,2,3,4,5.

DEFINITION OF OBJECTS

Designation	Command code	Description
Objects visible	#OVV Object-id, Object-id...	Visibility of objects Object-id . The Object-id = 0 , means that the command is used for all defined objects You can also input a range :("ID 1 - ID 10"). The order of processing depends on the specification of the two object IDs.
Object invisible	#OVI Object-id, Object-id...	Invisibility of objects Object-id . The Object-id = 0 , means that the command is used for all defined objects You can also input a range :("ID 1 - ID 10"). The order of processing depends on the specification of the two object IDs.
Set free anchor (0)	#OAS Anchor0X, Anchor0Y, Object-id, Object-id...	The free anchor Anchor = 0 of one ore more objects Object-id is set through the position Anchor0X, Anchor0Y .
Set free anchor (0) relatively	#OAO Anchor0X, Anchor0Y, Object-id, Object-id...	The free anchor Anchor = 0 of one or more objects Object-id is set through the position Anchor0X, Anchor0Y relatively to the objects. You can also input a range :("ID 1 - ID 10"). The order of processing depends on the specification of the two object IDs.
Set active anchor	#OAA Anchor, Object-id, Object-id...	Sets the anchor Anchor(0-9) of the objects. You can also input a range :("ID 1 - ID 10"). The order of processing depends on the specification of the two object IDs.
Group objects	#OGA Group-id, Object-id, Object-id...	Defines a group Group-id , consisting of different Object-id . You can also input a range :("ID 1 - ID 10"). The order of processing depends on the specification of the two object IDs. Informationen zu Gruppen befinden sich hier .

Designation	Command code	Description
Draw object frame	#OFP Drawstyle-nr, addL/R, addT/B, Object-id, Object-id...	Draws a frame around the object Object-id depending on the style Drawstyle-nr and additional dots around the object left/right addL/R and top/bottom addT/B . The Object-id = 0 , means that the command is used for all defined objects You can also input a range : ("ID1 - ID10"). The order of processing depends on the specification of the two object IDs.
Objekt delete	#ODI Object-id, Object-id...	Deletes one or more objects Object-id . Styles won't be deleted as they aren't objects..The Object-id = 0 , means that the command is used for all defined objects You can also input a range : ("ID1 - ID10"). The order of processing depends on the specification of the two object IDs.

CHANGE OF OBJECTS

Designation	Command code	Description
Change position absolut	#OPA PosX, PosY, Object-id, Object-id...	Change position PosX , PosY of one ore more objects Object-id . The Object-id = 0 , means that the command is used for all defined objects You can also input a range : ("ID1 - ID10"). The order of processing depends on the specification of the two object IDs.
Change position relativ	#OPR PosX, PosY, Object-id, Object-id...	Change relatively the position PosX , PosY of one ore more objects Object-id . The Object-id = 0 , means that the command is used for all defined objects You can also input a range : ("ID1 - ID10"). The order of processing depends on the specification of the two object IDs.
Change size absolut	#OSA Width, Height, Object-id, Object-id...	Changes width Width and height Height of one ore more objects Object-id . The Object-id = 0 , means that the command is used for all defined objects You can also input a range : ("ID1 - ID10"). The order of processing depends on the specification of the two object IDs.

Designation	Command code	Description
Change size relativ	#OSR Width, Height, Object-id, Object-id...	Changes width Width and height Height with addition or subtraction of one or more objects Object-id . The Object-id = 0 , means that the command is used for all defined objects You can also input a range : ("ID1 - ID10"). The order of processing depends on the specification of the two object IDs.
Change shear absolut	#OHA ShearX, ShearY, Object-id, Object-id...	Changes shearing ShearX, ShearY (degrees) of one or more objects Object-id . The Object-id = 0 , means that the command is used for all defined objects You can also input a range : ("ID1 - ID10"). The order of processing depends on the specification of the two object IDs.
Change shear relativ	#OHR ShearX, ShearY, Object-id, Object-id...	Changes shearing relativ ShearX, ShearY (degrees) of one or more objects Object-id . The Object-id = 0 , means that the command is used for all defined objects You can also input a range : ("ID1 - ID10"). The order of processing depends on the specification of the two object IDs.
Change rotation absolut	#ORA Angle, Object-id, Object-id...	Changes the angle Angle of one or more objects Object-id . The Object-id = 0 , means that the command is used for all defined objects You can also input a range : ("ID1 - ID10"). The order of processing depends on the specification of the two object IDs.
Change rotation relative	#ORR Angle, Object-id, Object-id...	Changes the angle relatively Angle of one or more objects Object-id . The Object-id = 0 , means that the command is used for all defined objects You can also input a range : ("ID1 - ID10"). The order of processing depends on the specification of the two object IDs.
Change transparency absolut	#OOA Opacity, Object-id, Object-id...	Changes the transparency Opacity of one or more objects Object-id . The Object-id = 0 , means that the command is used for all defined objects You can also input a range : ("ID1 - ID10"). The order of processing depends on the specification of the two object IDs.

Designation	Command code	Description
Change transparency relative	#OOR Opacity, Object-id, Object-id...	Changes the transparency relatively Opacity of one ore more objects Object-id . The Object-id = 0 , means that the command is used for all defined objects You can also input a range :("ID1 - ID10"). The order of processing depends on the specification of the two object IDs.
Change Draw-/Text-/Buttonstyle	#OCS Style-nr, Object-id, Object-id...	Changes the used style Style-nr (Drawstyle-nr, Textstyle-nr oder Buttonstyle-nr) of one ore more objects Object-id . The Object-id = 0 , means that the command is used for all defined objects You can also input a range :("ID1 - ID10"). The order of processing depends on the specification of the two object IDs.
Change color	#OCC AddR, AddG, AddB, Object-id, Object-id...	Change color RGB (e.g: \$FF0000 red) of one ore more objects Object-id through adding color parts AddR (-100...100), green AddG (-100...100) and blue AddB (-100...100). The Object-id = 0 , means that the command is used for all defined objects You can also input a range :("ID1 - ID10"). The order of processing depends on the specification of the two object IDs.
Change layer absolut	#OLA Nr, Object-id, Object-id...	Changes the object layer Nr of one ore more objects Object-id . The specified objects are assigned one after the other to the selected object plane, i.e. the last object is located on the desired object level and the other objects under it. If there is no "space" below the selected object level, the other objects are placed over it. Level 1 is the lowest level. You can also input a range : ("ID1 - ID10"). The order of processing depends on the specification of the two object IDs. Example: #OLA 1, 1, 2, 3 Object 3 is on layer 1. Object 2 on layer 2 and object 1 on layer 3.
Change layer absolut	#OLR Difference, Object-id, Object-id...	Changes the layer raltive to ech object Object-id . Positive numbers set the object to a higher, negative numbersto a lower layer. You can also input a range :("ID1 - ID10"). The order of processing depends on the specification of the two object IDs.

VARIABLES AND REGISTERS

Parameters that are written in **GREY** in the command tables are considered optional details, and partially have default values. The default values are given in brackets behind the corresponding parameters. Parameters written in **BLACK** on the other hand, must be assigned values. Commands that may contribute towards changing parameters can only be used if the corresponding parameters have already previously been defined. Some commands allow for entering several object IDs. Should these objects be in numerical sequence, the range may be specified with the "-" sign, e.g. 1-5, instead of 1,2,3,4,5.

Designation	Command code	Description
Load string file	#VFL 'Stringfilename'	Loads the string file ' Stringfilename '. You can load in maximum 8 String files with 1000 different strings in the maximum. Unter ' Stringfile ' sind Details über deren Verwendung zu finden
Delete string file	#VFD 'Stringfilename'(Alle Stringdateien löschen)	Deletes the selected or all strings of file ' Stringfilename '.
Count strings of string files	#VFC	Sends the amount of strings given through the string files. A more precise description of the system response can be found in the chapter Responsens. (#HAR)(#VFC)
Set string register	#VSS String-id, 'String', String(id + 1), String(id + 2)	Saves a string ' String ' in string register String-id . Additional strings are stored in the following registers. The length is 255 characters for each string register.
Set string register position	#VSP String-id, pos, 'String'	Saves a string ' String ' in string register String-id starting at position pos .
String register Date/Time	#VSD String-id, DateFormat(#WDF), Date32(datetime())	Uses the date format DateFormat to store time and date Date32 in string register String-id .
Stringregister Formatstring	#VSF String-id, Formatstring (printf), Value1, Value2...	Saves a formatted string ' Formatstring ' in string register String-id with the help of Value . You can find details about ' formatted strings ' here..
Copy object sting to string register	#VSO String-id, Object-id, Objekt(id+1), Objekt(id+2)	Writes a string of a object Object-id to string register String-id .
Read string register (ASCII)	#VSA String-id, String-id	Sends a string register String-id as ASCII. You can define a range of registers to send with '-'. E.g.g S1-S4, so register 1,2,3,4 are send. A more precise description of the system response can be found in the chapter Responsens. (#HAR)(#VSA)
Read string register (Unicode)	#VSU String-id, String-id	Sends a string register String-id as unicode. You can define a range of registers to send with '-'. E.g.g S1-S4, so register 1,2,3,4 are send. A more precise description of the system response can be found in the chapter Responsens. (#HAR)(#VSU)

Designation	Command code	Description
Set register (Integer)	#VRI Register-id, Integer, Integer(id +1)	Saves an integer value or calculation output Integer to register Register-id . Further values are stored in the following registers
Set register (Float)	#VRF Register-id, Float, Float(id +1)	Saves a float value or calculation output float to register Register-id . Further values are stored in the following registers
Read register Int/Float	#VRG Register-id, Register-id, Register-id	Sends a register Register-id value (integer/float). You can define a range of registers to send with '-'. E.g.g S1-S4, so register 1,2,3,4 are send. A more precise description of the system response can be found in the chapter Responsens. (#HAR) (#VRG)

MACROS

General information on macros can be found here.

Parameters that are written in **GREY** in the command tables are considered optional details, and partially have default values. The default values are given in brackets behind the corresponding parameters. Parameters written in **BLACK** on the other hand, must be assigned values. Commands that may contribute towards changing parameters can only be used if the corresponding parameters have already previously been defined. Some commands allow for entering several object IDs. Should these objects be in numerical sequence, the range may be specified with the "-" sign, e.g. 1-5, instead of 1,2,3,4,5.

EXECUTING MACROS

Designation	Command code	Description
Execute macro	#MRN "Makroname"	The " Macro Name " macro (file name) is executed.
Execute macro with condition	#MRC Condition, "Makroname" true; "Makroname" false(Kein Makro)	The " Macro Name " macro (true) is executed if the condition Condition is fulfilled. Otherwise, ' Macro Name '(false) is executed.
Execute port macro	#MRP Port	The port macro for the port Port (0-15) is executed.
Execute bit macro	#MRB Bit, Edge	The bit macro for the bit Bit (0-127) with the flank Edge (0= Falling; 1= Increasing) is executed.
Execute touch macro	#MRT Object-id, TouchState	The touch macro, which is defined by the touch function Touch State (1= Not Pressed; 2= Pressed; 4= Drag) in the touch object Object ID , is executed.
End macro file prematurely	#MFE Condition(wahr)	Ends the macro prematurely if the condition Condition is fulfilled.
Skip macro file lines	#MFS Condition(wahr), Lines(1)	Skips lines Lines in the macro if the condition Condition is fulfilled.
Set macro file marker	#MFM Marker-nr(0)	Sets a marking in the macro file Marker No. (0-9).
Jump from macro file to marker	#MFJ Condition, Marker-nr(0)	Jumps to the previously defined marking Marker No. (0-9) if the condition Condition is fulfilled.
Delete macro definitions	#MCD Mask	Delete all macro definitions. Through Mask , it is established which group of macros is deleted (1=Second; 2= Process; 4= Port; 8= Bit; 16= Analogue; 32= Touch; 64= Operation). The addition of the individual flag in the Mask results in the combined deletion of the respective macro groups. Thus, when entering Mask=3, second and process macros are deleted.

DEFINITION OF MACRO PROCESSES AND TOUCH MACROS

Designation	Command code	Description
Macro process	#MPD Prozess-nr, Time, "Makroname"; , Startnr(Keine), Endnr(Startnr), Type(1)	Defines a process macro with the process number Process No. (1-10). The " Macro Name " macro is accessed at time intervals Time(hrs). Multiple macros can, optionally, be executed. For this purpose, the "Macro Name" needs to end with at least one figure. The start Start Number and end End Number macros are handed over as optional parameters, and equipped with an Animation Typen Type (1-6). Should, for instance, Macro Name= Photo, StartNo.= 1, Time= 100 and End No.= 6 be used, then "Photo1"→"Photo2"→...→Photo6 will be accessed at intervals of a second.
Conditional macro	#MPC Prozess-nr, Conditiontime, Condition, "Makroname"; , Startnr(Keine), Endnr(Startnr), Type(1)	Defines a process macro with the process number Process No. (1-10). It is queried at the interval ConditionTime (hrs) whether the condition Condition is fulfilled. Should the Condition =TRUE, then the macro "Macro Name" is executed. The option exists to access multiple macros. For that purpose, the start and end macros are, as it were, give a Start No. and End No. , and equipped with a type of animation Type (1-6), see #MPD .
Automatically changing macro	#MPA Prozess-nr, Calculationtime, Change, "Makroname"; , Startnr(Keine), Endnr(Startnr), Type(1)	Defines a process macro with the process number Process No. (1-10). The " Macro Name " macro is only accessed if there changes in value in the Change calculation . The calculation is always of the "Integer" data type. The time Calculation Time (hrs) determines the interval of the query of the calculation result. Should the current result have changed in comparison to the previous result, the "Macro Name" macro is executed. The option exists to access multiple macros. For that purpose, the start and end macros are, as it were, give a Start No. and End No. , and equipped with a type of animation Type(1-6), see #MPD .
Change process time	#MPT Prozess-nr, Time	Changes the time Time (hrs) after which a macro is accessed in the process macro Process No. In order to be able to use this command, it is necessary to define a process macro in advance.

Designation	Command code	Description
Define port macro	#MHP Port, "Makroname"(delete old macro)	Should the status of the I/O pins of the port Port (0-15) be altered, the macro is accessed " Macro Name ". Should the command be executed without a " Macro Name ", the current macro definition is deleted.
Define bit macro	#MHB Bit, Edge, "Makroname"(delete old macro)	Defines the macro " Macro Name " for the port pin Pin (0-127) and the flank Edge (0= Falling; 1= Increasing). Should the command be executed without a " Macro Name ", the current macro definition is deleted.
Define analogue macro	#MHA Channel, AnalogType, "Makroname" (delete old macro)	Defines in the channel Channel (0-3) the " Macro Name " macro The Type of the analogue macro AnalogueType needs to be taken into consideration in the process. Should the command be executed without a " Macro Name ", the current macro definition is deleted.
Define RTC second macro	#MDS , "Makroname" (delete old macro)	Accesses the macro " Macro Name " every second. Should the command be executed without a " Macro Name ", the current macro definition is deleted.
Define operation end macro	#MDA Object-id, "Makroname" (delete old macro)	Defines an end macro in the object Object ID . The "Macro Name" macro is only executed once the operation of the object has come to an end Object ID. Should the command be executed without a "Macro Name", the current macro definition is deleted.
Define touch macro	#MDT Object-id/Group-id, "Makroname down" (delete old macro); "Makroname up" (Altes Makro löschen), "Makroname drag" (Altes Makro löschen)	Defines a touch function in the object Object ID or in the object group Group ID . In that respect, " Macro Name " macros are specified for the pressed (down), unpressed (up) and maintained (drag) states. The corresponding object Object ID needs to be defined for the latter as a touch object. Should the command be executed without a " Macro Name ", the current macro definition is deleted.

TYPES OF ANALOGUE MACROS

The hysteresis of the analogue channel set is observed. There is a description [here](#) of how to set the limits and the hysteresis..

Designation	Parameter	Description
Change	0	The macro is accessed with any changes in value.
Reduction	1	The macro is accessed when there are changes in value.
Increase	2	The macro is accessed when there are increases in value.
Fail to reach lower limit	3	The macro is accessed when failing to reach the lower limit.
Failing to reach lower limit	4	The macro is accessed when exceeding the lower limit
Failing to reach upper limit	5	The macro is accessed when failing to reach the upper limit.
Exceeding upper limit	6	The macro is accessed when exceeding the upper limit
Leaving the border window	7	The macro is accessed when leaving the window predefined by the two limits.
Entering the border window	8	The macro is accessed when entering the window predetermined by the two limits.

TIME AND DATE

Parameters that are written in **GREY** in the command tables are considered optional details, and partially have default values. The default values are given in brackets behind the corresponding parameters. Parameters written in **BLACK** on the other hand, must be assigned values. Commands that may contribute towards changing parameters can only be used if the corresponding parameters have already previously been defined. Some commands allow for entering several object IDs. Should these objects be in numerical sequence, the range may be specified with the "-" sign, e.g. 1-5, instead of 1,2,3,4,5.

Designation	Command code	Description
Set time and date	#WTD Hour, Min(Alte Werte), Sec(Alte Werte), Day(Alte Werte), Month(Alte Werte), Year(Alte Werte)	Sets the time, hour Hour , minute Min and second Sec and date Day , month Month and year Year . The RTC is buffer with a coin battery 364.
Send time in binary format	#WSB Date32(Aktuelle Zeit)	Sends the actual time or the time given through Date32 . A more precise description of the system response can be found in the chapter Responsens. (#HAR)(#WSB)
Set format string for time	#WDF DateFormat	Sets the format of time and date. DateFormat als formatierter String (Example) angegeben werden. Details about time string format are listed here
Send time ASCII	#WSA DateFormat(#WDF), Date32(Aktuelle Zeit)	Sends the actual time or the time given through Date32 in the date format DateFormat as ASCII. Date format commands are shown here . A more precise description of the system response can be found in the chapter Responsens. (#HAR)(#WSA)
Send time unicode	#WSU DateFormat(#WDF), Date32(Aktuelle Zeit)	Sends the actual time or the time given through Date32 in the date format DateFormat as Unicode. Date format commands are shown here . A more precise description of the system response can be found in the chapter Responsens. (#HAR)(#WSU)
Define month names	#WDM 'Jan'(January); 'Feb'(February); 'Mar'(March); 'Apr'(April); 'May'(May); 'Jun'(June); 'Jul'(July); 'Aug'(August); 'Sep'(September); 'Okt'(October); 'Nov'(November); 'Dec'(December)	Defines the names for the months ' Jan ' - ' Dec '
Define month names	#WDW 'Mon'(Monday), 'Tue'(Tuesday), 'Wed'(Wednesday), 'Thu'(Thursday), 'Fri'(Friday), 'Sat'(Saturday), 'Sun'(Sunday)	Defines the names for the days ' Mon ' - ' Sun '.
Objectgroup as clock	#WGC Group-id, IndicatorH-id, IndicatorM-id, IndicatorS-id	Defines an object group Group-id as clock. To use the hour- IndicatorH-id , minute- IndicatorM-id or optionally the second IndicatorS-id indicator, objects of the groups must be assigned to it. Beispiel siehe S. 123

ACTION

Allgemeine Informationen zu Aktionen befinden sich [hier](#).

Parameters that are written in **GREY** in the command tables are considered optional details, and partially have default values. The default values are given in brackets behind the corresponding parameters. Parameters written in **BLACK** on the other hand, must be assigned values. Commands that may contribute towards changing parameters can only be used if the corresponding parameters have already previously been defined. Some commands allow for entering several object IDs. Should these objects be in numerical sequence, the range may be specified with the “-” sign, e.g. 1-5, instead of 1,2,3,4,5.

OPERATIONAL CURVES AND PATHS

Designation	Command code	Description
Define operation curve	#ACD ActionCurve-Nr, X1, Y1, X2, Y2	The action curve describes the chronological course of an operation, e.g. accelerating and decelerating. What is defined is an operational curve Operational Curve-No. (1... 10) through the positions X1, 2 (0... 100) and Y1, 2 (-200...300). For information on default curves and more precise explanations, see Pre-defined operational curves .
Define operation path	#APD ActionPath-nr, StartX, StartY, Segment1, Segment2,...	Defines an operational path action path (1... 10) through the position Xstart, Ystart and the successive segments . The operational path describes the way in which the operation is supposed to be performed.

DEFINE ACTION

Designation	Command code	Description
Action define	#ADC Start/End	Start/End (Finish= 0; Start= 1) Commands which chronologically follow #ADC1 are only executed if the definition of the operation is terminated by #ADC0 . As a result, multiple objects or operations that are generated or are supposed to begin simultaneously can be defined.

ACTION

Designation	Command code	Description
Define absolute action	#AOA Object-id, Action, Action2, ...	Defines an operation action for an object Object ID absolutely. For an explanation of the operations possible, see definition an action .

Designation	Command code	Description
Define relative action	#AOR Object-id, Action, Action2, ...	Defines an operation action for an object Object ID relatively. For an explanation of the operations possible, see definition an action .
Define type of action	#AOT Object-id, ActionType, TotalTime (100), DelayStart(0), DelayEnd(0)	Defines a type of action Type of Action for the object Object ID assigned, depending upon the total duration TotalTime (hs), the start delay DelayStart(hrs) and premature termination DelayEnd (hrs). An operation for the object Object ID needs to have been determined in advance for this command. For an explanation of the various types of operation, see type of operation
Cancel action	#AOS Object-id, Stop(0), Next(0)	Defines the end of an operation Stop (0= Now; 1= Start of an operation; 2= End of an operation) and subsequent step Next (0= Stopping normally; 1= Jump; 2= Delete object) for the object assigned Object ID . An operation for the object Object ID needs to have been determined in advance for this command.

DEFINE ACTIONS

Designation	Parameter	Description
Position curve	101-110 PosX, PosY	Defines the position PosX , PosY . The object is moved in a straight line to the point specified. Beispiel siehe S. 107
Position curve path	151-160 Actionpath-nr, Offset	The object follows the operational path Action Path No. , or is placed on the latter. The starting value Offset (0...100) determines the starting point on the operational path on a percentage basis. Beispiel siehe S. 107
Scale curve	201-210 ScaleX, ScaleY	Defines the size ScaleX , ScaleY as a percentage of the original size of the object. Beispiel siehe S. 107
Scale curve path	251-260 Actionpath-nr, Offset	The object is scaled over the operational path ActionPath No. The starting value Offset (0...100) determines the starting size on the operational path on a percentage basis. Beispiel siehe S. 107
Rotation curve	301-310 Angle	Defines the rotational angle Angle . Negative angle for rotation in a clockwise direction Beispiel siehe S. 108
Rotation curve path	351-360 Actionpath-nr, Offset	The object is rotated over the operational path Action Path No. The starting value Offset (0...100) determines the starting angle on the operational path on a percentage basis. Beispiel siehe S. 108
Shear curve	401-410 ShearX Shear Y	Defines a shearing ShearX , ShearY in degrees. Beispiel siehe S. 108
Shear curve path	451-460 Actionpath-nr, Offset	The object is sheared over the operational path Action Path No. The starting value Offset (0...100) determines the starting shearing on the operational path on a percentage basis.
Opacity curve	501-510 Opacity	Defines the transparency Opacity (0..100). Beispiel siehe S. 109
Colour offset curve	601-610 Red, Green, Blue	Defines a colour addition of the colour components red Red (-100...100), green Green (-100...100) and blue Blue (-100...100). Beispiel siehe S. 109

ACTION TYPE

Example on contemplating the types of operation

#AOT id, X, 100

The parameter “X” corresponds to the parameters of the types of operation in the following table.

Designation	Parameter	Description
Appearing	1	Defines an appearing behaviour for the operation selected. The object is generated at its generation point (400,240), depending upon the definition of the operation. That means that it will fly in from the position specified (1000,600), taking into account the size specified (25%), and be scaled to its original size.
Disappearing	2	Defines a disappearing behaviour for the operation selected. The course proceeds in the opposite direction to the appearance, in other words the object is moved from the position in which it is generated to the position specified with a corresponding change in its size. The object is subsequently deleted.
Invisible	3	Defines a fading out behaviour for the operation selected. The course is the same as that of the disappearing behaviour, however the object is not deleted after the operation, but becomes invisible. That means that it does not need to be re-defined for later uses
Change	4	Defines a one-off change in the parameters for the operation selected. The course is the same as that of the disappearing behaviour, however the object is not deleted after the operation.
Cyclical	5	Defines a cyclic behaviour for the operation selected. The course corresponds to the changing behaviour, however the latter is constantly repeated
Oscillating (ping-pong)	6	Defines an oscillating behaviour for the operation selected. The course resembles that of the cyclic behaviour, however with the difference that the object is not constantly moved from the point of its generation to the position specified, but always oscillates between the latter with the dimensioning specified.

PRE-DEFINED ACTION CURVES

The course of the operation can be defined in the case of the operational curves. The chronological course of 0 to 100% can be found on the X axis. The Y axis specifies the corresponding allocated value. The latter concerns a cubic spline with two supporting points. The EA uniSketch Windows program offers help in generating one's own curve.

Action curve	Curve points	Visualisation
1: Linear	$X1 = 10; Y1 = 10; X2 = 90; Y2 = 90$	<p>The graph displays a straight blue line on a coordinate system where both the x-axis and y-axis range from 0 to 100 with major grid lines every 10 units. The line starts at the origin (0,0) and extends diagonally to the top-right corner (100,100).</p>
2: Accelerating → linear	$X1 = 40; Y1 = 0; X2 = 60; Y2 = 40$	<p>The graph shows a blue curve on a coordinate system with axes from 0 to 100. The curve starts at (0,0) and remains very close to the x-axis until approximately x=20, then curves upwards with an increasing slope, passing through approximately (40, 10), (60, 40), and finally reaching (100,100).</p>
3: Linear → reducing speed	$X1 = 40; Y1 = 60; X2 = 60; Y2 = 100$	<p>The graph displays a blue curve on a coordinate system with axes from 0 to 100. The curve starts at (0,0) and follows a linear path until approximately x=40, where it begins to curve downwards, becoming flatter as it approaches the point (100,100).</p>

Action curve	Curve points	Visualisation
4: Accelerating → linear → reducing speed	$X1 = 40; Y1 = 0; X2 = 60; Y2 = 100$	
5: Undershooting → linear	$X1 = 30; Y1 = 0; X2 = 30; Y2 = -60$	
6: Linear → overshooting	$X1 = 70; Y1 = 160; X2 = 70; Y2 = 100$	

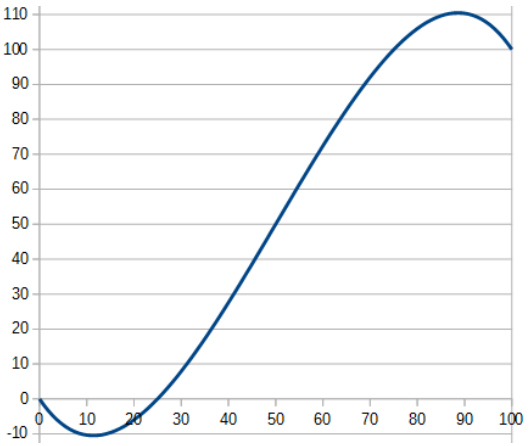
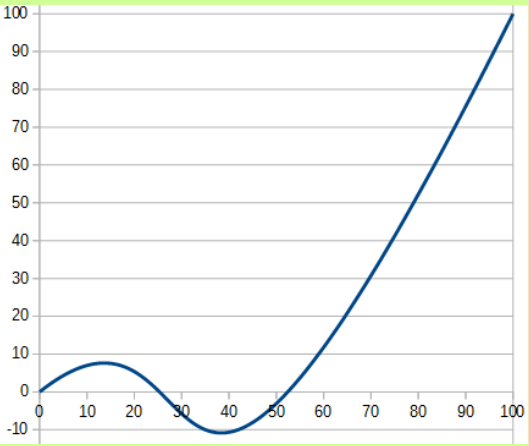
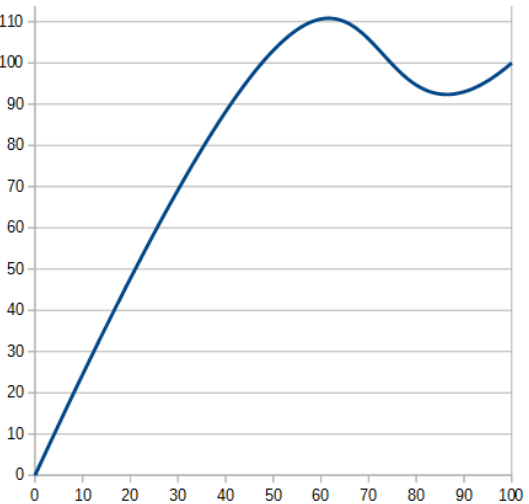
Action curve	Curve points	Visualisation
7: Undershooting → linear → overshooting	X1 = 30; Y1 = -60; X2 = 70; Y2 = 160	 <p>The graph shows a blue curve on a coordinate system with x-axis from 0 to 100 and y-axis from -10 to 110. The curve starts at (0,0), reaches a minimum of approximately -5 at x=15, then rises to cross the x-axis at x=25, continues to rise to a peak of approximately 110 at x=85, and finally ends at approximately 100 at x=100.</p>
8: Oscillating → linea	X1 = 40; Y1 = 40; X2 = 20; Y2 = -100	 <p>The graph shows a blue curve on a coordinate system with x-axis from 0 to 100 and y-axis from -10 to 100. The curve starts at (0,0), rises to a peak of approximately 8 at x=15, dips to a trough of approximately -5 at x=35, and then rises linearly to reach the target value of 100 at x=100.</p>
9: Linear → oscillating	X1 = 80; Y1 = 200; X2 = 60; Y2 = 60	 <p>The graph shows a blue curve on a coordinate system with x-axis from 0 to 100 and y-axis from 0 to 110. The curve starts at (0,0) and rises linearly to reach the target value of 100 at x=60. After x=60, the curve oscillates, reaching a peak of approximately 110 at x=65, dipping to approximately 90 at x=85, and ending at approximately 100 at x=100.</p>

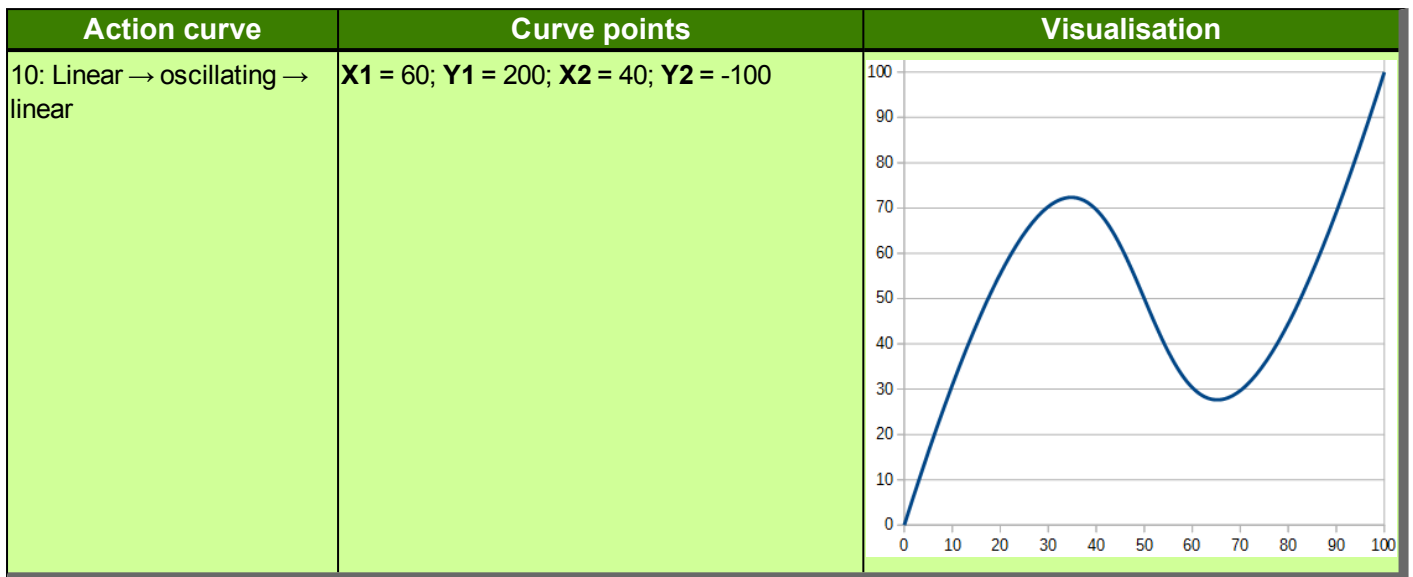

KEYBOARD

To generate special keys, such as *Shift*, *Backspace* or *CAPSLOCK*, corresponding parameters need to be set in the "Button String". So that the parameters find their application, a *Backslash* '\' needs to be placed in front of them.

The "Button String" command describes the sequence of the keys within a line. In order to insert more lines, the latter need to be separated by entering '|' or ';' at the end of the line.

Parameters that are written in **GREY** in the command tables are considered optional details, and partially have default values. The default values are given in brackets behind the corresponding parameters. Parameters written in **BLACK** on the other hand, must be assigned values. Commands that may contribute towards changing parameters can only be used if the corresponding parameters have already previously been defined. Some commands allow for entering several object IDs. Should these objects be in numerical sequence, the range may be specified with the "-" sign, e.g. 1-5, instead of 1,2,3,4,5.

Parameter	Description
\1: (code 1)	Show Keyboard No. 1.
\2: (code 2)	Show Keyboard No. 2.
\3: (code 3)	Show Keyboard No. 3.
\4: (code 4)	Show Keyboard No. 4.
\5: (code 5)	ShiftKey switches over to Keyboard No. 2. Once a key has been entered, there is an automatic return to Keyboard No. 1.
\6: (code 6)	Switch over to CapsLockKey between Keyboard No. 1 and Keyboard No. 2.
\7: (code 7)	Delete deletes the characters to the right of the cursor.
\8: (code 8)	BACKSPACE deletes the characters to the left of the cursor.
\A: (code 10)	Move to the beginning of the next line; <i>reserved for future use</i>
\B: (code 11)	Insert / Overwrite switches between inserting text and overwriting text.
\C: (code 12)	CLEAR deletes the entire entry.
\D: (code 13)	Enter / Return confirms the entry and sets the entry as a new default string (#SED).
\E: (code 14)	Left arrow key
\F: (code 15)	Rightarrow key
\G: (code 16)	Up arrow key; <i>reserved for future use</i>
\H: (code 17)	DownUp arrow key; <i>reserved for future use</i>
\I: (code 18)	Pos1 jumps to the beginning of the entry.
\J (code 19)	Ende jumps to the end of the entry.
\L: (code 21)	Escape breaks off the entry and returns to the default string(#SED).
\N: (code 23)	Placeholder for an unused and not yet defined key.
\O..\V: (code 24 .. 31)	8 x function keys

Designation	Command code	Description
Define keys	#KDB Group-id, Nr, "ButtonStringLine1", "ButtonStringLine2"...	Defines as an object group Group ID the key sequence of the keyboard " Button String Line ", depending upon the keyboard number No. and the sequence of the keys. Further key sequences may be specified. Should the same key be entered several times in a row, then the width of the key generated changes in proportion. The latter shall also apply to spaces. Beispiel siehe S. 114
Define alternative labelling	#KDL Group-id, Code," ButtonText"	Changes the labelling " Button Text " in the object group Group ID with the special Code keys Beispiel siehe S. 114
Define styles	#KDC Group-id, Gap, ButtonStyle1 normal, ButtonStyle 1 special, Button Style2 normal, ButtonStyle2 special...	Defines for the object group Group ID the spacing between keys Gap , as well as the button style for normal ButtonStyle normal and special ButtonStyle special .keys A maximum of five button style pairs can be entered. The numbers of the button style specify the key length for which the style is effective. Beispiel siehe S. 114
Place keyboard	#KPK Group-id, PosX, PosY, Anchor, Width, Height	Positions the object group Group ID , depending upon the position, PosX , PosY , the anchor Anchor and the width Width . Entering the height Height is optional. Beispiel siehe S. 114

PERIPHERALS - INTERFACE

The module has various interfaces:

- 4 [analogue inputs](#) (12-bit precision)
- 1 [PWM](#) output (16-bit precision)
- [Video input](#) (PAL/SECAM Analogue)
- [Audio output](#) (8-ohm loudspeaker, max. 1 W)
- 16 digital [I/O](#), extendable to up to 128 (max. 20 mA)
- 3 serial interfaces [RS232](#), [SPI](#), [I²C](#)

Parameters that are written in **GREY** in the command tables are considered optional details, and partially have default values. The default values are given in brackets behind the corresponding parameters. Parameters written in **BLACK** on the other hand, must be assigned values. Commands that may contribute towards changing parameters can only be used if the corresponding parameters have already previously been defined. Some commands allow for entering several object IDs. Should these objects be in numerical sequence, the range may be specified with the “-” sign, e.g. 1-5, instead of 1,2,3,4,5.

ANALOGUE

Designation	Command code	Description
Calibrate analogue converter	#HAC	Executes the calibration of the analogue converter.
Analogue input - hysteresis	#HAH Channel, Hysteresis (1)	Defines the hysteresis of the analogue input Channel (0-3). Not all changes in value are displayed by specifying hysteresis Hysteresis, but only changes in value as from the size specified. If the hysteresis is not specified, all changes in value are displayed, i.e. Hysteresis = 1.
Read analogue input	#HAL Channel, Limit, Limit2	Defines an upper and lower limit Limit , Limit 2 for the analogue input Channel (0-3).
Read analogue input	#HAR Channel(0), Number(4)	Scans the analogue input Channel (0-3). The number Number (1-4) specifies the number of inputs to be read. Example: Channel = 1, Number = 2 leads to the analogue inputs 1 and 2 being scanned, and displayed via the serial interface. A more precise description of the system response can be found in the chapter Responsens. (#HAR) (#HAR)

PULSE WIDTH MODULATION (PWM)

Designation	Command code	Description
PWM output frequency	#HFO Frequency32Bit , OnTime(no change), TotalTime(no change)	Defines the frequency Frequency (2Hz-1MHz) of the PWM output. Internal splitters lead to not every frequency being precisely adjustable. The ratio of on time to off time is determined by the two parameters OnTime/TotalValue . Beispiel siehe S. 111
Duty cycle - PWM output	#HFD OnTime, TotalTime(no change)	Changes the ratio of on time to off time OnTime/TotalValue .

PORT

Designation	Command code	Description
Port setting	#HPC Port, I/O, ...	Setting for the entire port(0-15). In this context, I/O (0-0xFF) defines the respective port bit as an input (1) or output (0). Further specifying I/O defines the next higher value port. Beispiel siehe S. 111
Set outputs	#HPW Port, PortState, ...	Bring output of the component Port into the PortState state (0-255). Further details of PortState describe the next port component. Beispiel siehe S. 111
Read inputs	#HPR Port(0), Number(2)	Scans the port component Port (0-15). Multiple port components can be read with the number Number (1-16). As the standard, two port components exist. A more precise description of the system response can be found in the chapter Responsens. (#HAR) (#HPR)
Information on the port module	#HPI	Return of the connected port components. A more precise description of the system response can be found in the chapter Responsens. (#HAR) (#HPI)
Port pin setting	#HBC Pin, Output/Input, ...	Determines whether the port pin Pin (0-127) is defined as an input or output Output/Input (0= Output; 1= Input). Further specifying Output/Input defines the next higher value Pin .
Set port pin output	#HBW Pin, BitState, ...	Describes the Bit State state (0, 1, 2= invert) of the output pin Pin (0-127). Further specifying Bit State defines the state of the next higher value Pin .

Designation	Command code	Description
Read port pin input	#HBR Pin(0), Number(16)	Scans the port pin Pin (0-127). Multiple port components can be scanned with the number Number (1-128). A more precise description of the system response can be found in the chapter Responsens. (#HAR) (#HBR)

VIDEO AND AUDIO

Designation	Command code	Description
Play sound	#HTP "Soundname"	Plays back the sound file with the name Sound Name . Only *.esd files can be played back. The easiest way to create these files is using the EA uniSketch Win-dEA uniSketch.
Stop sound	#HTS	Stops the playback of the sound file.
Video input window	#HVB Left(0), Top(0), Width(720), Height (576)	Window setting of the video input with left Left and top Top offset, as well as width Width and height Height .

RS232 MASTER INTERFACE

Designation	Command code	Description
Send ASCII	#HRA "string"	Sends a text ' string ' via the RS232 Master Interface as ASCII code.
Send Unicode	#HRU "string"	Sends a text ' string ' via the RS232 Master Interface as Unicode.
Send binary code	#HRS len32Bit, Data	Sends binary data data having the length len via the RS232 Master Interface. The length needs to be under 1 kB.
Send file	#HRF <Filename>	Sends a file < Filename > via the RS232 Master Interface.
Data received	#HRR len32Bit (1024)	Scans the length len of the data received via RS232. The maximum length permitted is 1 kB. If the length is greater than the available data, only the latter are transmitted. A more precise description of the system response can be found in the chapter Responsens. (#HAR) (#HRR)

Designation	Command code	Description																		
RS232 parameter	#HRP Baudrate32Bit	Baud rate setting Baud rate of the master RS232 interface with 8-N-1. Baud rates: <table border="1" data-bbox="997 353 1492 851"> <thead> <tr> <th>Baudrates</th> <th>Error rate in %</th> </tr> </thead> <tbody> <tr> <td>9600</td> <td>+0,04</td> </tr> <tr> <td>19200</td> <td>-0,08</td> </tr> <tr> <td>38400</td> <td>+0,16</td> </tr> <tr> <td>57600</td> <td>-0,08</td> </tr> <tr> <td>115200</td> <td>+0,64</td> </tr> <tr> <td>230400</td> <td>-0,80</td> </tr> <tr> <td>460800</td> <td>+2,08</td> </tr> <tr> <td>921600</td> <td>-3,68</td> </tr> </tbody> </table>	Baudrates	Error rate in %	9600	+0,04	19200	-0,08	38400	+0,16	57600	-0,08	115200	+0,64	230400	-0,80	460800	+2,08	921600	-3,68
Baudrates	Error rate in %																			
9600	+0,04																			
19200	-0,08																			
38400	+0,16																			
57600	-0,08																			
115200	+0,64																			
230400	-0,80																			
460800	+2,08																			
921600	-3,68																			

SPI MASTER INTERFACE

Designation	Command code	Description
Send ASCII	#HSA "string"	Sends a text ' string ' via the SPIMaster Interface as ASCII code.
Send Unicode	#HSU "string"	Sends a text ' string ' via the SPI Master Interface as Unicode.
Send binary code	#HSS len, Data	Sends binary data data having the length len via the SPI Master Interface. The length needs to be under 1 kB.
Send file	#HSF <Filename>	Sends a file < Filename > via the SPI Master Interface.
Data received	#HSR len32Bit	Scans the length len of the data received via RS232. The maximum length permitted is 1 kB. If the length is greater than the available data, only the latter are transmitted. A more precise description of the system response can be found in the chapter Responsens. (#HAR)(#HRR)
CS pin setting	#HSC State	Setup of the CS line: State (0=low (manually); 1=high (manually); 2=automatic)).

Designation	Command code	Description
SPI parameter	#HSP Frequency32Bit (in Hz), SPI Mode, DataOrder	Defines the parameters of frequency Frequency (15.6kHz-1MHz), mode SPI Mode (0-3) and data sequence Dataorder (0=MSB (Most Significant Bit)) of the SPI. The clock frequency is set to the Frequency, in regard to which internal splitters lead to the actual frequency always being the same or slower. Information on the SPI specification can be found here .

I²C

Designation	Command code	Description
Send ASCII	#HIA "string"	Sends a text ' string ' via the I ² C Master Interface as ASCII code.
Send Unicode	#HIU "string"	Sends a text ' string ' via the I ² C Master Interface as Unicode.
Send binary code	#HIS len32Bit, Data	Sends binary data data having the length len via the I ² C Master Interface. The length needs to be under 1 kB.
Send file	#HIF <Filename>	Sends a file < Filename > via the SPI Master Interface.
Data received	#HIR len32Bit	Scans the length len of the data received via RS232. The maximum length permitted is 1 kB. If the length is greater than the available data, only the latter are transmitted. A more precise description of the system response can be found in the chapter Responsens. (#HAR)#HRR
I ² C Parameter	#HIP Adress8Bit, Frequency32Bit	Defines the parameters of address Address and frequency Frequency(3.9kHz-1MHz) for the I ² C transmission. Information on the I ² C specification can be found here .

SYSTEM COMMANDS

Parameters that are written in **GREY** in the command tables are considered optional details, and partially have default values. The default values are given in brackets behind the corresponding parameters. Parameters written in **BLACK** on the other hand, must be assigned values. Commands that may contribute towards changing parameters can only be used if the corresponding parameters have already previously been defined. Some commands allow for entering several object IDs. Should these objects be in numerical sequence, the range may be specified with the “-” sign, e.g. 1-5, instead of 1,2,3,4,5.

Bezeichnung	Befehlscode	Beschreibung
Define project path	#XPS </Absolute path>	Defines the project path. Information on the path details can be found here .
Read project path	#XPG	Writes the current project path into the transmission buffer. A more precise description of the system response can be found in the chapter Responsens. (#HAR) (#XPG) .
Send version	#XIV	Writes the version string into the transmission buffer. A more precise description of the system response can be found in the chapter Responsens. (#HAR) (#XIV) .
Display info	#XID	Writes the display parameters, such as the width and height, into the transmission buffer. A more precise description of the system response can be found in the chapter Responsens. (#HAR) (#XID)
SD Card info	#XIS	Writes information on the SD card into the transmission buffer. A more precise description of the system response can be found in the chapter Responsens. (#HAR) (#XIS)
RAM info	##XIR	Writes information on the internal RAM into the transmission buffer.. A more precise description of the system response can be found in the chapter Responsens. (#HAR) (#XIR)
Display orientation	#XCO Angle	Changes the angle Angle(0, 90, 180, 270) for aligning the display.
Define virtual display resolution	#XCV Width(Displaywidth), Height(Displayheight), Touchwidth(Width), Touchheight(Height)	Defines the virtual display resolution through the width Width , height Height , touch width Touchwidth and touch height Touchheight . It is therefore possible for the size of programs to be adjusted to small and large displays automatically.
Define display brightness	#XCB Brightness, Time, Flash	Defines the brightness Brightness (0-100) of the display, making reference to the modification time Time (hrs). The value can be saved permanently. Flash 0= Do not save; 1= Save.

Bezeichnung	Befehlscode	Beschreibung
RS232 slave parameter	#XCR Baudrate, RS485 Adress(no change), Flash(0)	Defines the parameters for the RS232 slave: Baud rate (default = 115200) and RS485 Address (default = 7). The value can be saved in the flash memory Flash (0= Do not save; 1= Save). The format for the data transmission is 8-N-1. Dhe available baud rates are listed here .
SPI slave parameter	#XCS SPI-Mode, DataOrder(no change), Flash(0)	Setting the SPI modes (0-3) (default = 3) and bit sequence DataOrder (0= MSB First; 1= LSB first) (default= 0). he value can be saved permanently. Flash 0= Do not save; 1= Save. Informations on the SPI-Mode can be found here .
I ² C slave adress	#XCI Adress8Bit, Flash(0)	Set I ² C slave address 8-bit address (default 0xDE). The value can be saved permanently. Flash 0= Do not save; 1= Save..
ASCII string to sending buffer	#XSA 'String'	Transmits the character string ' String ' to the transmission buffer as an ASCII string. This command is intended for displaying the Stringregister .
Unicode string to sending buffer	#XSU 'String'	Transmits the character string ' String ' to the transmission buffer as an Unicode string. This command is intended for displaying the Stringregister .
Hard copy to file	#XHF <File>, PictureFormat(1), x(0), y(0), Anchor (7), width (display width), height (display height)	ave screenshot in the PictureFormat format, and the dimensions x, y, anchor, width, height under the File path and nameGeneral information on the picture format can be found here .
Hard copy to serial interface	#XHS PictureFormat(1), x1(0), y1(0),Anchor (7), width (display width - 1), height (display height -1)	Save screenshot in the PictureFormat format, and place the dimensions x, y, width, height in the transmission buffer. General information on the picture format can be found here .
Hardcopy of video image to file	#XVF <File>, , PictureFormat	Save still image of the video window in the PictureFormat format under the File path and name.Save file. General information on the picture format can be found here .
Hardcopy of video image to serial interface	#XVS PictureFormat	Place still image of the video window in the PictureFormat format into the sending buffer.IGeneral information on the picture format can be found here .

Bezeichnung	Befehlscode	Beschreibung								
Interrupt program sequence	#XXW Wait	Stops the program sequence for the duration of the waiting period Wait(hrs). This command is suitable for debugging purposes. The module works does not process any further commands during this period.								
Touch adjustment (only resistive)	#XXT	Starts the adjustment of the resistive touch. The user needs to touch two predefined points on the screen.								
Firmware reboot (HW-Reset)	#XFB Option	The command executes a complete restart of the module. The parameter Option selects the boot mode:: <table border="0"> <tr> <td>1 Testmode</td> <td>Display parameters and information of the module on the display.</td> </tr> <tr> <td>2 Disable PowerOnMacro</td> <td>Deactivates the start of the PowerOn macro (start emc).</td> </tr> <tr> <td>3 Disable Default</td> <td>Deactivates all standard macros. No default settings are loaded.</td> </tr> <tr> <td>4 Bootmenu</td> <td>All projects to be found on the SD card are listed, and can be started.</td> </tr> </table>	1 Testmode	Display parameters and information of the module on the display.	2 Disable PowerOnMacro	Deactivates the start of the PowerOn macro (start emc).	3 Disable Default	Deactivates all standard macros. No default settings are loaded.	4 Bootmenu	All projects to be found on the SD card are listed, and can be started.
1 Testmode	Display parameters and information of the module on the display.									
2 Disable PowerOnMacro	Deactivates the start of the PowerOn macro (start emc).									
3 Disable Default	Deactivates all standard macros. No default settings are loaded.									
4 Bootmenu	All projects to be found on the SD card are listed, and can be started.									

BOOT MENU AND TOUCH ADJUSTMENT THROUGH GESTURES

Both the resistive touch adjustment **#XXT**) and the boot menu **#XFB** can be accessed via two different gestures at the time of the restart.

For that purpose, directly at the start of the display (max. 1 second later), the latter needs to be pressed with a finger until the confirmation is obtained. After a further second, a message is displayed about whether a touch adjustment is supposed to take place or the boot menu is supposed to be accessed.

Should the touch adjustment take place, the finger needs to be briefly lifted, and then pressed on the display again, until the request for adjustment comes. This is the pressing of two points on the display.

Should, on the other hand, the boot menu start, the finger needs to be briefly lifted and subsequently pressed on the display twice at brief intervals.

Should neither of the two things occur, the finger may either remain on the display or be removed from the display.

The boot menu can be seen in the figure below.



The boot menu is divided into three areas.

On the left are the various projects that can be started by dialling.

On the lower right-hand side all macros can be deactivated, the test mode started or the accessing of the boot menu interrupted.

On the right-hand side at the top, the option of a one-off or permanent (saved) accessing of the corresponding selection is selected by pressing.

FILE ACCESS

Parameters that are written in **GREY** in the command tables are considered optional details, and partially have default values. The default values are given in brackets behind the corresponding parameters. Parameters written in **BLACK** on the other hand, must be assigned values. Commands that may contribute towards changing parameters can only be used if the corresponding parameters have already previously been defined. Some commands allow for entering several object IDs. Should these objects be in numerical sequence, the range may be specified with the “-” sign, e.g. 1-5, instead of 1,2,3,4,5.

SD-CARD

The options for specifying the path are listed [here](#).
General information on the SD card can be found [here](#).

Designation	Command	Description
Set working path	#FDS <Path>	Defines the working path Path . When relative paths are specified, this folder is taken as the basis.
Reading back working path	#FDG	Read working path. A more precise description of the system response can be found in the chapter Responsens. (#HAR) (#FDG)
List directory completely	#FDR <Path> (Arbeitspfad)	Listing the files and folders that exist in the path Path . A more precise description of the system response can be found in the chapter Responsens. (#HAR) (#FDR)
List directory completely in the ASCII format	#FDA <Path> (Arbeitspfad)	Listing the files and folders that exist in the path Path . They are displayed in ASCII format. A more precise description of the system response can be found in the chapter Responsens. (#HAR) (#FDA)
List directory folders	#FDL <Path> (Arbeitspfad)	Listing the folders that exist in the Path . A more precise description of the system response can be found in the chapter Responsens. (#HAR) (#FDL)
Create directory	#FDC <Path>	Create new directory in the working directory Path .
Delete directory	#FDD <Path>, Content(0)	Delete content Content (0= Content only; 1= Folder and content) in the working directory Path .
Open/create file for writing	#FWO <Path + Filename>, Pos (0)	Open file with the name File Name for writing, optionally specifying the path Path at the position Pos . If the file does not exist, it is created.
Write content into file	#FWD Num, Data	Describes the opened and writeable file with the number Num of binary values Data .
Write (ASCII) content into file	#FWA "String"	The ascii string String is written into the open file.

Designation	Command	Description
Write (Unicode) content into file	#FWU "String"	The Unicode string String is written into the open file..
Close writeable file	#FWC	Closes the file that is presently open and writeable.
Open file for reading	#FRO <Path + Filename>, Pos (0)	Open file with the name File Name for reading, optionally specifying the path Path at the position Pos .
Read content of file	#FRD Anz (gesamtes File)	Reads the content of the open and readable file. A more precise description of the system response can be found in the chapter Responsens. (#HAR)(#FRD)
Close file for reading	#FRC	Closes the file that is presently open and readable.
Delete file	#FFD <Path + Filename>	Delete file
Info on file/directory	#FFI <Path (Arbeitsverzeichnis)>	transmits information on the current direction/file Path . A more precise description of the system response can be found in the chapter Responsens. (#HAR)(#FFI)
Change file/directory name	#FFR <Path>, <NewName>, Replace(0)	Changes the name of the file or directory at the location Path with the new designation NewName . Should another file exist with the same name, the behaviour is defined by Replace (0= Only change if the file does not already exist; 1= Always change → Other file is deleted).
Copy file/directory	#FFC <PathOld>, <PathNew>, Replace(0)	Copies the file or directory from the original location PathOld to the new location PathNew . If a file with the same name exists, the behaviour is defined by Replace (0= Copy if file does not already exist; 1= Overwrite).
Move file/directory	#FFM <PathOld>, <PathNew>, Replace(0)	Shifts the file or directory from the original location PathOld to the new location PathNew . If a file with the same name exists, the behaviour is defined by Replace (0= Shift if file does not already exist; 1= Overwrite).
File/directory Time stamp	#FFT <Path>, time, date	The time stamp is comprised of the time and date together. .For an explanation on file time, e see p. 102.

Designation	Command	Description
File/directory Change properties	#FFA <Path>, Fileattribute	Sets a new attribute for the Path file specified. The File Attribute parameter is designed as follows: Write-protected 0x01 Hidden 0x02 System 0x04 Archive 0x20 The flag attributes can be combined through simple bit ORing.
Saving a uniTFT file	#FSO <Path>, File-Data	Saves an object file of the uniTFT's (e.g. *.epg) in the specified path Path .
Load file names into string register	#FNF <Path> (Arbeitsverzeichnis)	Saves the number in Register R1 and the name of the files in S1, S2, ... from the destination folder Path . S. number Should, for example, the two directories "Project1" and "Project2" be present in the destination folder, as well as the file "start.emc", the number "1" is saved in Register R1, and the "start" string in the String Register S1.
Load directory names into string register	#FND <Path> (Arbeitsverzeichnis)	Saves the number in Register R1 and the names of the folders in S1, S2, ... from the destination folder Path . S. number Should, for example, the two directories "Project1" and "Project2" be present in the destination folder, as well as the file "start.emc", the number "2" is saved in the register R1, the "Project1" string in the String Register S1 and the "Project2" string in the String Register S2.

FILE TIME

The file time is comprised of the date and time together. In the FAT file system, the time specification has a resolution of 2 s, calculated as from 00:00:00 hours on 01/01/1980.

Bit	15	14	13	12	11	10	9	8	7	6	5	4	3	2	1	0
Date	JYear, counting from 1980 (0..127)						Month(1..12)			Day(1..31)						
Time	Hour(0..23)					Minute (0..59)					Second/2 (0..29)					

Brief example for converting the time:

Date = ((Year-1980)<<9) + (Month<<5) + Day;

Time =(Hour<<11) + (Minute<<5) + (Second>>1);

RESPONSES

General information on macros can be found here..

Parameters that are written in **GREY** in the command tables are considered optional details, and partially have default values. The default values are given in brackets behind the corresponding parameters. Parameters written in **BLACK** on the other hand, must be assigned values. Commands that may contribute towards changing parameters can only be used if the corresponding parameters have already previously been defined. Some commands allow for entering several object IDs. Should these objects be in numerical sequence, the range may be specified with the "-" sign, e.g. 1-5, instead of 1,2,3,4,5.

Designation	Command code	Description
Send version	#XIV String, 0	Returns the current version as a string . (←XIVEA uniTFT V1.0)
Display info	#XID Width 16Bit, Height 16Bit, Colordepth 8Bit, Touch 8Bit, Videowidth 16Bit, Videoheight 16Bit	Returns the width Width , height Height , colour depth Colour depth (16-bit/24-bit), touch control function, Touch (0 = No touch control; 3 = resistive; 7 = capacitive; 15 = PC mouse) and the dimensions of the video image through the latter's width, Video Width and height, Video Height . Should the value 1 (top/bottom) or 2 (left/right) be returned when using Touch, then the other respective directional value is missing.
RAM info - byte	#XIR Gesamt RAM 32Bit, Frei RAM 32Bit	Return of the overall and available memory on the SD card in KB.
SD Card info in KB	#XIS Gesamt SD 32Bit, Frei SD 32Bit	Rückgabe des Gesamt- und freien Speichers auf der SD-Karte in KB.
Time in binary code	#WSB Hour 16Bit, Min 16Bit, Sec 16Bit, Day 16Bit, Month 16Bit, Year 16Bit, Week-day 16Bit	Returns the time and date in hours Hours , minutes, mins , and seconds, Secs , day Day , month Month , year Year and week-day Weekday (0=Sunday).
Time - ASCII	#WSA String, 0=Ende	Returns the time and date as a string in ASCII code. (e.g. "#WSA08:30:36\n Tuesday, 3 May 2016")
Time in Unicode	#WSU UnicodeString, 0=Ende	Returns the time and date as a string in Unicode code. (e.g. "#WSU08:30:36\n Tuesday, 3 May 2016")
Retain project path	#XPG String, 0	Returns the project path as a string .
Hard copy to serial interface	#XHS Bitmap Header, Data	Sends a screenshot to the serial interface.
Retain working directory	#FDG String, 0, 0=Ende	Displays the working directory as a string .

Designation	Command code	Description
Read directory	#FDR NameString , 0, Filesize 32Bit, File-attribute8Bit, Modified Time 16Bit, Modified Date16Bit, ..., ..., 0=ENDE	Reads the content of the directory with name Name String , size File Size and properties, File Attributes . The file attributes can be combined through bit ordering. Write-protected 0x01 Hidden 0x02 System 0x04 Archive 0x20
Read directory (ASCII)	#FDA SizeString, Datestring, Timestring, Namestring, 0x0D, 0x0A, ..., ..., 0=ENDE	Reads the content of the directory as ASCII code with size Size String , date Date String , time Time String and name Name String .
List directories	#FDL Namestring, 0, Namestring, ..., 0=ENDE	Lists the directories with the name Name String .
Info on directories	#FFI NameString , 0, Filesize 32Bit, File-attribute8Bit, Modified Time 16Bit, Modified Date16Bit, ..., ..., 0=ENDE	Displays information on the directory with name, Name String , size, File Size and properties, File Attributes . The file attributes can be combined through bit ORing. Write-protected 0x01 Hidden 0x02 System 0x04 Archive 0x20
Read file content	#FRD Len 32Bit, Data	Transmits the content of the file opened for reading, Data , complete with the length, Len .
Number of port modules	#HPI Subscriber16Bit	Information about which port module is connected. Subscriber is bit-coded. Bit0 = Address 0 .. Bit7 = Address 7...
Read Port(Byte)	#HPR Portnr 8Bit, Number 8Bit, Value 8Bit	The port status Value is transmitted. Portnr /port number specifies the port as from which data is being read, number the number of ports to be read.
Read Port(Bit)	#HBR Bitnr 8Bit, Number 8Bit, Value 8Bit	The pin status Value is transmitted. Bit Number specifies the port pin as from which data is read, number the number of pins to be read.
Read analogue input	#HAR Channel 8Bit, Number 8Bit, Value 16Bit	The analogue value, Value , is transmitted. Channel specifies the analogue channel as from which data is read, number the number of channels to be read.
Master RS232 data	#HRR Len 32Bit, Data	Return of the data received via the Master-RS232, Data , with the length Len .

Designation	Command code	Description
Master SPI data	#HSR Len 32Bit, Data	Return of the data received via the Master-SPI , Data , with the length Len .
Master I ² C data	#HIR Len 32Bit, Data	Return of the data received via the Master-I ² C, Data , with the length Len .
String file - number	#VFC Number 16Bit	Displays the number, Number , of the strings contained in the string file.
String register - ASCII	#VSA Number 16Bit, StrLen 16Bit, String	Displays the string, String of the string register, with the number, Number and the string length, StrLen , as an ASCII string..
String register in Unicode	#VSU Number 16Bit, StrLen 16Bit, UnicodeString	Displays the string, String of the string register, with the number, Number and the string length, StrLen , as an Unicode-string...
Read register	#VRG Number 16Bit, Type 16Bit, Value 32Bit	Returns the content, Value , of the register number . In this context, Type determines whether the value is an "I" = integer or "F"=Float.
Request touch control button status	#TQS Object-id 16Bit, Status 16Bit	Displays the Status (1=Up; 2=Down) of the touch control switch, Object ID .
Request the status of the active switch of the radio group	#TQR Group-id 16Bit, Object-id 16Bit	Displays the Object ID of the active touch control switch of the radio group, Group ID ..
Display touch code for key-board	#TGK Object-id16Bit, Code16Bit	Displays the Code of the touch control button of the keyboard, Object ID .
Display touch value instrument	#TQI Object-id16Bit, Value16Bit	Displays the Value , of the instrument Object ID .

EXAMPLES OF COMMANDS

In the following, most of the graphical commands are illustrated by brief examples.

OPERATION AND ANIMATION

Position curve, scale curve

Operational path with change of position

Draw a straight line in order to visualise the operational path

#GPL 1, 2, 100,100, 700,200

Insert a circle with a filling

#GET 2, 1, 100, 100, 5, 60

Move operatoin via Path 1

#AOA 2, 101, 700, 200

Define type of operation and time of operation

#AOT 2, 5, 500

For the complete set of commands of the sample image [see p. 131](#).

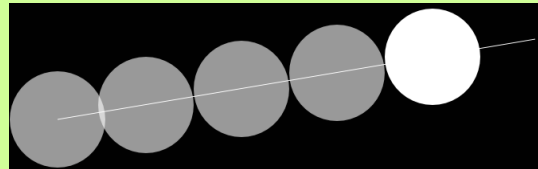

Elliptical operational path with change of position

Insert an ellipse polypath in order to visualise the operational path

#GPP 1, 2, 400, 80 ?E0, 300, 150, 0, 400, 380 ?E0, 300, 150, 0, 400, 80

Insert a circle with a filling

#GET 2, 1, 400, 80, 5, 60

Define ellipse and line operational path. The path corresponds to Object 1

#APD 1, 400, 80 ?E0, 300, 150, 0, 400, 380 ?E0, 300, 150, 0, 400, 80

Move operation via Path 1

#AOA 2, 151, 1, 0

Define type of operation and time of operation

#AOT 2, 1, 400

For the complete set of commands of the sample image [see p. 133](#).

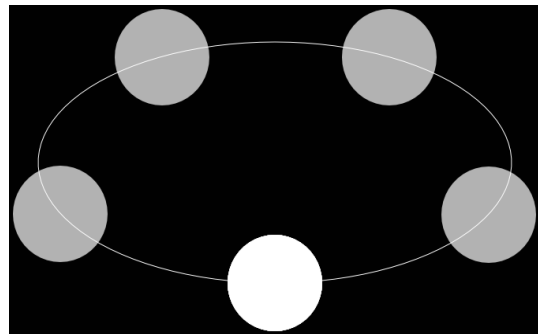

Changing the size

Insert a circle with a filling

#GET 1, 1, 200, 200, 5, 50

Double the size of the operation

#AOA 1, 201, 200, 200

Define type of operation and time of operation

#AOT 1, 5, 500

For the complete set of commands of the sample image [see p. 131](#).

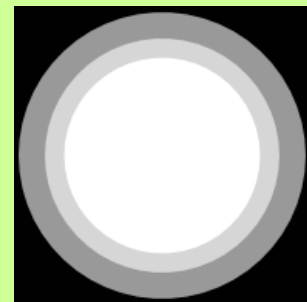

Changing the size and position

Insert a polypath ellipse in order to visualise the operational path

#GPP 1, 2, 400, 80 ?E0, 300, 150, 0, 400, 380 ?E0, 300, 150, 0, 400, 80

Insert a circle with a filling

#GET 2, 1, 400, 80, 5, 60

Define ellipse operational path. The path corresponds to Object 1

#APD 1, 400, 80 ?E0, 300, 150, 0, 400, 380 ?E0, 300, 150, 0, 400, 80

Change in size of operational path

#APD 2, 100, 100 ?L, 30, 30 ?L, 100, 100

Operational movement and change in size

#AOA 2, 151, 1, 0, 251, 2, 0

Define type of operation and time of operation

#AOT 2, 1, 400

For the complete set of commands of the sample image [see p. 132](#).

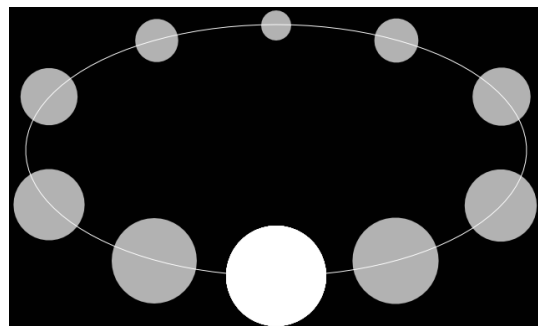

Rotation Curve, Shear Curve

Rotation

Define rectangle as being horizontal

#GRR 1, 1, 50,100,4, 300,40,5

Operational rotation through 90° anti-clockwise

#AOA 1, 301, 90

Define type of operation and time of operation

#AOT 1, 4, 500



For the complete set of commands of the sample image [see p. 132](#).

Changing the rotation and position

Insert an ellipse polypath in order to visualise the operational path

#GPP 1, 2, 400, 80 ?E0, 300, 150, 0, 400, 380 ?E0, 300, 150, 0, 400, 80

Insert a circle with a filling

#GRR 2, 1, 400, 80, 5, 20,100,2

Define ellipse operational path. The path corresponds to Object 1

#APD 1, 400, 80 ?E0, 300, 150, 0, 400, 380 ?E0, 300, 150, 0, 400, 80

Change in size of operational path

#APD 2, 100, 100 ?L, 30, 30 ?L, 100, 100

Move operation along the path, revolving

#AOA 2, 151, 1, 0, 351,1,0

Define type of operation and time of operation

#AOT 2, 1, 400

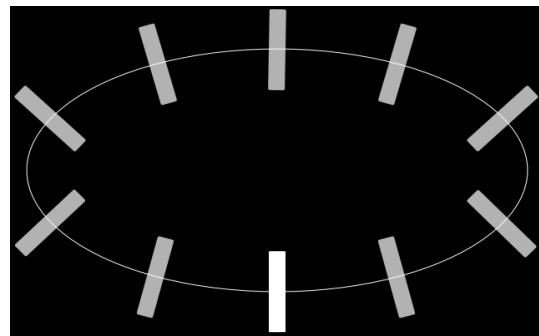

For the complete set of commands of the sample image [see p. 134](#).

Distort

Define square

#GRR 1, 1, 100,100,5, 80,80,5

Operation: Shearing of object by 40° on both axes

#AOA 1, 401, 40,40

Define type of operation and time of operation

#AOT 1, 4, 500



For the complete set of commands of the sample image [see p. 134](#).

Opacity curve, colour offset curve

Opacity

Define square

#GRR 1, 1, 100,100,5, 80,80,5

Operation: change the alpha channel

#AOA 1, 501, 20

Define type of operation and time of operation

#AOT 1, 4, 500

For the complete set of commands of the sample image [see p. 130](#).



Colour transformation

Define square

#GRR 1, 1, 100,100,5, 80,80,5

Colour transformation operation Remove red and green portion

#AOA 1, 501, -100,-100

Define type of operation and time of operation

#AOT 1, 4, 500

For the complete set of commands of the sample image [see p. 130](#).



BILD / VEKTORGRAFIKEN

Bilder / Vektorgrafiken

Plazierung eines (Vektor-)Bildes

Tiger platzieren, Größe proportional skalieren

#PPP 1, "tiger"; 400, 240, 5, 150



Plazierung einer Animation mit Typänderung

Erde platzieren, Größe proportional skalieren

#PPP 1, "Erde"; 400, 240, 5, 150

Zyklische Animation in eine Ping-Pong-Animation (pendelnd) ändern

#PPA 1,3

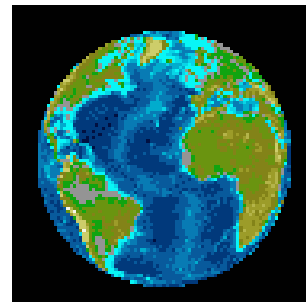

Video

Plazierung eines Videobildes

Video platzieren, Größe proportional skalieren

#PVP 1, 400, 240, 5, 300



EIN- UND AUSGÄNGE

PWM

PWM Ausgang

PWM Frequenz 1 kHz, 100 µs high, 900 µs low

#HFO 1000,10, 100

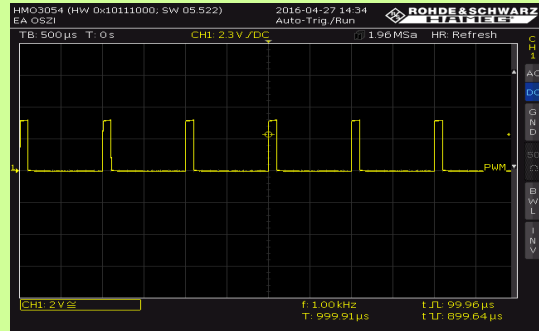

I/O Port

Port Control

Port 0 abwechselnd als Ein und Ausgang, Port 1, 2 Aus, 6 Eingänge

#HPC 0, \$AA, \$03

Port 0 (Bit 0-7)	Port 1 (Bit 8-15)
<input checked="" type="checkbox"/> <input type="checkbox"/> <input checked="" type="checkbox"/> <input type="checkbox"/> <input checked="" type="checkbox"/> <input type="checkbox"/> <input checked="" type="checkbox"/> <input type="checkbox"/> <input checked="" type="checkbox"/>	<input type="checkbox"/> <input checked="" type="checkbox"/> <input checked="" type="checkbox"/> <input checked="" type="checkbox"/> <input checked="" type="checkbox"/> <input checked="" type="checkbox"/> <input checked="" type="checkbox"/> <input checked="" type="checkbox"/>

Port Ausgänge

Port 0 abwechselnd als Ein und Ausgang, Port 1, 2 Aus, 6 Eingänge

#HPC 0, \$AA, \$03

Verfügbare Ausgänge Abwechselnd An und Ausschalten

#HPW 0, \$44, \$A8

Port 0 (Bit 0-7)	Port 1 (Bit 8-15)
<input checked="" type="checkbox"/> <input type="checkbox"/> <input type="checkbox"/> <input type="checkbox"/> <input type="checkbox"/> <input type="checkbox"/> <input type="checkbox"/> <input type="checkbox"/>	<input type="checkbox"/> <input checked="" type="checkbox"/> <input checked="" type="checkbox"/> <input checked="" type="checkbox"/> <input checked="" type="checkbox"/> <input checked="" type="checkbox"/> <input checked="" type="checkbox"/> <input checked="" type="checkbox"/>

INSTRUMENTS

#IBR, IBT, IBA, IGM, IGS, IPP, IVA,

Bar graph with rounded corners

Bar graph with green gradient as a foreground, inclusive of the white frame. Background plain blue.

#IBR 1, 1, 2, 150, 70, 4, 300, 50, 15
Set bar graph to the value 70.

#IVS 1, 70

For the complete set of commands of the sample image [see p. 136](#).

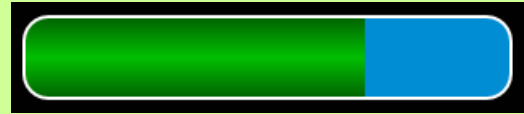

Triangular bar graph

Bar graph with green gradient as a foreground, inclusive of the white frame. Background plain blue.
As an indication, the three possible positions of the point have been highlighted.

#IBT 1, 1, 2, 150, 70, 4, 300, 100
Set bar graph to the value 70.

#IVS 1, 70

For the complete set of commands of the sample image [see p. 135](#).

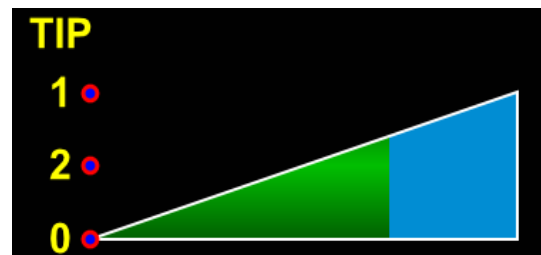

Arc - bar graph

Bar graph with green gradient clockwise as a foreground, inclusive of the white frame. Background plain blue.

#IBA 1, 1, 2, 150, 70, 4, 300, 45, 45, 135
Set bar graph to the value 70.

#IVS 1, 70

For the complete set of commands of the sample image [see p. 137](#).

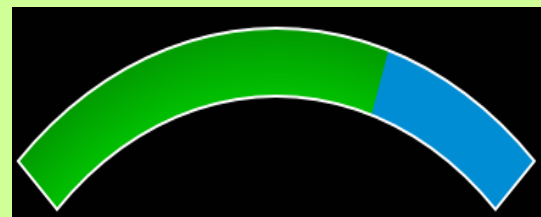

Object group as a rotational instrument

Defines Object Group 2 as a rotational instrument.

#IGM 2, 180, -180, -90, 90

For the complete set of commands of the sample image [see p. 137](#).

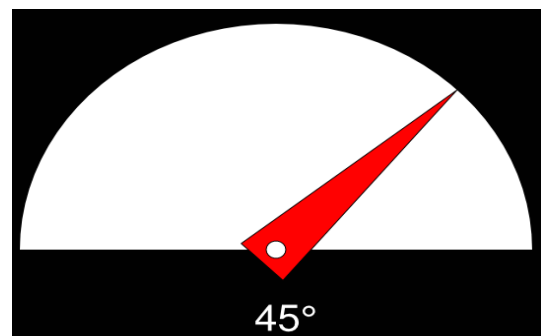

#IBR, IBT, IBA, IGM, IGS, IPP, IVA,

Object group as a slider

Defines Object Group 3 as a slider

#IGS 3, 1, 2, 0, 0, 100

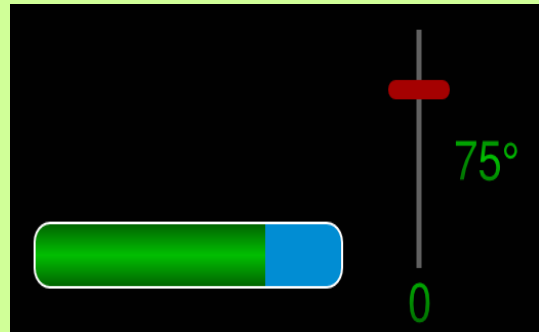

For the complete set of commands of the sample image [see p. 138](#).

Wattmeter as an instrument

Place instrument file; original image size, start value =0, end value =500

#IPP 1, "Wattmer"; 400,200,5,0,0,0,500

Set bar graph to 70% (0.7x500)

#IVS 1, 350



For the complete set of commands of the sample image [see p. 136](#).

Bar graph value update

Rectangular bar, with start and end value, adjusted to seconds

#IBR 1, 1, 2, 150, 70, 4, 300, 50, 15,0,59

Change bar automatically with the second

#IVA 1,(second())



For the complete set of commands of the sample image [see p. 136](#).

KEYBOARD

#KDB, KDL, KDC, KPK

Object group as a keyboard field

Define Object Group 5 as a keyboard field
Generating the keyboard field for Keyboard1

#KDB 5, 1, "^1234567890ß\8\C"; "\6qwertzuiopü+\D\D"; "\5asdfghjklöä#\N"; "<yxcvbnm,.-"; ""

Generating the keyboard field for Keyboard2

#KDB 5, 2, "!"\$%&/'()=?\8\C"; "\6QWERTZUIOPÜ*\D\D"; "\5ASDFGHJKLÖÄ#\N"; ">YXCVBNM;_"; ""



For the complete set of commands of the sample image [see p. 139](#).

Change key labelling of the special keys

Change labelling of the special keys in Object Group 5

#KDL 5, 5 "Shift"; 6 "Caps"; 8 "Back"; 12 "Clear"; 13 "Return"



For the complete set of commands of the sample image [see p. 139](#).

Define button style for keys

Define button style for normal and special keys of Length 1

#KDC 5, 1, 2

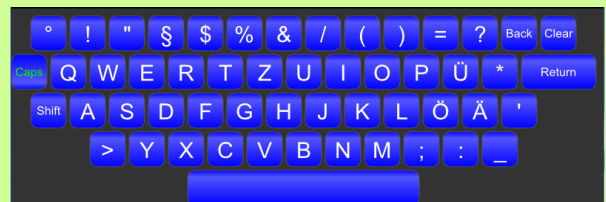

For the complete set of commands of the sample image [see p. 139](#).

Place object group as a keyboard

Places Object Group 5 as a keyboard

#KPK 5, 0, 0, 7, 800



For the complete set of commands of the sample image [see p. 139](#).

STRING ZEICHENKETTENBEFEHLE

#SSP, SFP, SAP

Zeichenkette platzieren

Platzierung einer einfachen Zeichenkette

[#SSP](#) 1, 1, 50, 50, 17, "Hello World"



Formatierte Zeichenkette platzieren

Platzierung einer formatierten Zeichenkette

[#SFP](#) 1, 1, 50, 50, 17, "Int: %d, Float: %.3f, Hex: 0x%02X"; 3, 3.14, 13



Formatierte sich selbst erneuernde Zeichenkette platzieren

Sobald sich der Analogeingang 0 ändert wird diese Zeichenkette neu dargestellt

[#SAP](#) 1, 1, 50, 50, 17, "Analog In 0: %.2f V"; (3.3/4095*analog(0))



Update-Kalkulation ändern

Sobald sich der Analogeingang 0 ändert wird diese Zeichenkette neu dargestellt

[#SAP](#) 1, 1, 50, 50, 17, "Analog In 0: %.2f V"; (3.3/4095*analog(0))

Ab jetzt wird die Zeichenkette im Sekundentakt erneuert, wobei weiterhin der Analogwert angezeigt wird

[#SAC](#) 1, (second())

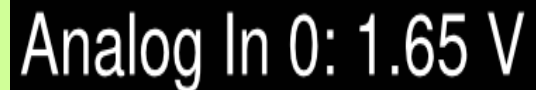

Date and Time

Placing a formatted date

[#SDP](#) 1, 1, 50, 50, 17, "%W the %D. %3N %Y, %1h:%m"



For the complete set of commands of the sample image [see p. 140](#).

EDITBOX

#SEP, SEK, SEA

Platzierung Editbox

Platzierung von drei Editboxen

#SEP 6, 20, 400, 280, 8, 300, 50, 6, 21, -5, -3

#SEP 7, 20, 400, 340, 8, 300, 50, 6, 22, 5, -3

#SEP 8, 20, 400, 400, 8, 300, 50, 6, 23, 5, -3



For the complete set of commands of the sample image [see p. 140](#).

Zuweisung von drei Editboxen auf eine Tastatur

Editboxen 6-8 der Tastatur 9 zuweisen

#SEK 9, 6-8

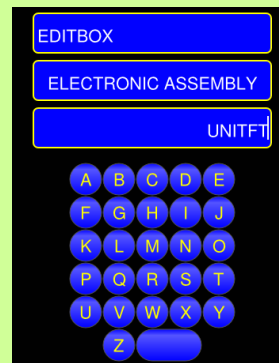

For the complete set of commands of the sample image [see p. 140](#).

Aktivierung Editbox

Aktiviert Editbox 8, die oberste der drei Editboxen

#SEA 8

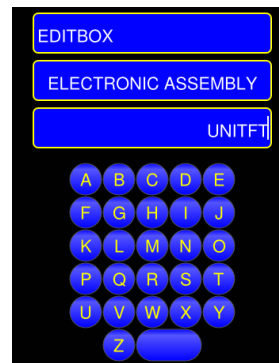

For the complete set of commands of the sample image [see p. 140](#).

STYLE SHEETS

Farbverlauf und Linienmuster

Farbverlauf
Erstellung eines Gradientenverlaufs mit 3 Stützpunkten RGB,
wobei Grün leicht durch den Alphakanal abgedunkelt wird.
[#CCR](#) 1, 0,\$FF0000,100, 50,\$00FF00,70, 100,\$0000FF,100

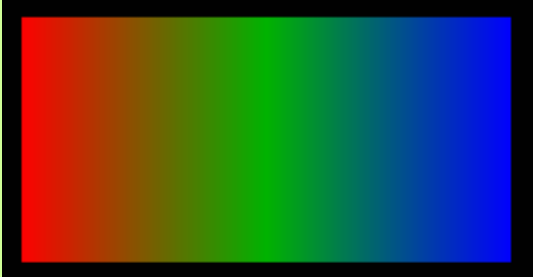

For the complete set of commands of the sample image [see p. 141](#).

Linienmuster
Erstellung eines Linienmusters (Dash pattern),
[#CDP](#) 1, 0, 20,10, 5,10

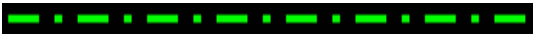

For the complete set of commands of the sample image [see p. 141](#).

Füllungen

Einfarbige Füllung

Füllfarbe definieren, der Alphakanal ist optional,

[#CFC](#) 1, \$00FF00

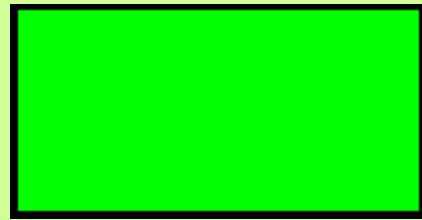

For the complete set of commands of the sample image [see p. 142](#).

Lineare Farbverlaufsfüllung

Gradientenverlauf als linearen Verlauf nutzen - um 45° geneigt

[#CFL](#) 1, 1, 45

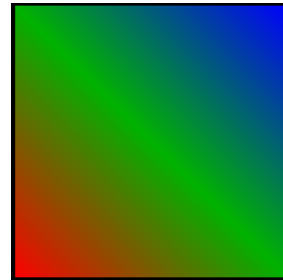

For the complete set of commands of the sample image [see p. 142](#).

Radiale Farbverlaufsfüllung

Gradientenverlauf als radialen Verlauf nutzen. Anker 5 als Fokuspunkt nutzen

[#CFR](#) 1, 1, 5000,5

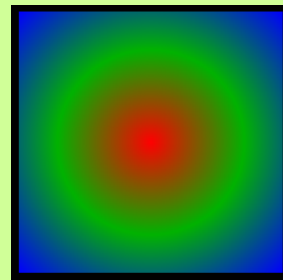

For the complete set of commands of the sample image [see p. 142](#).

Konische Farbverlaufsfüllung

Gradientenverlauf als konischen Verlauf nutzen.

Anker 5 als Fokuspunkt nutzen. Die Drehrichtung ist im Uhrzeigersinn

[#CFK](#) 1, 1, 5000,5

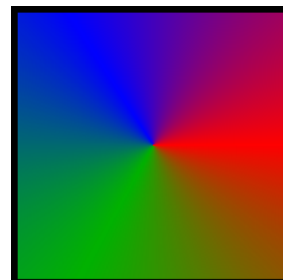

For the complete set of commands of the sample image [see p. 142](#).

Füllungen

Musterfüllung

Füllung mit sich selbst wiederholendem Muster

`#CFP 1, "marmor02"`

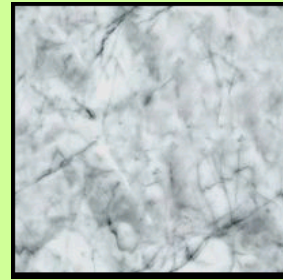

For the complete set of commands of the sample image [see p. 142](#).

Linienstyle

Linienfarbe und -dicke

Keine Füllung definieren

`#CFD 1`

grüne Linie mit 5 Pixel dicke

`#CLS 1, $00FF00, 100, 5`

Rechteck zeichnen

`#GRR 1, 1, 50, 50, 7, 200, 100`



For the complete set of commands of the sample image [see p. 143](#).

Linienverbindung

Linienverbindung mit abgerundeten Ecken (Round = 1)

`#CLE 1, 1`

Linienverbindung mit spitzen Ecken (Miter = 0)

`#CLE 2, 0`



For the complete set of commands of the sample image [see p. 143](#).

Textstyle

Textstyle

Erstellung eines Textstyles mit dem internen Font "Sans"

`#CTF 1, <!:Sans.evf>, 60, 1, 1`

Hello World

For the complete set of commands of the sample image [see p. 143](#).

Buttonstyle

Touchbutton als Bild

Zwei Bilder als Touchbuttonstyle definieren

#CBP 1, "Padlock_closed"; "Padlock_opend"

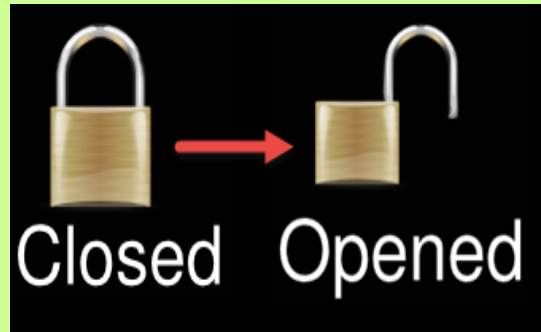

For the complete set of commands of the sample image [see p. 144](#).

Touchbuttonstyle für geometrische Objekte

Touchbuttonstyle mit 200 Breite, 50 Höhe und Eckenradius 50

#CBD 1, 5,6, 200,50,10

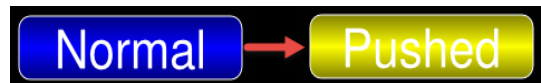

For the complete set of commands of the sample image [see p. 144](#).

Touchbutton Proportion bei Drücken ändern

Touchbutton soll seine Größe auf 70% im
gedrückten Zustand ändern

#CBO 1, 0,0, 70



For the complete set of commands of the sample image [see p. 144](#).

TERMINAL COMMANDS

Terminal window

(Re-)define terminal window

Small terminal window with 40 characters and 20 lines

`#YDW 1,30,30,7,40,20`

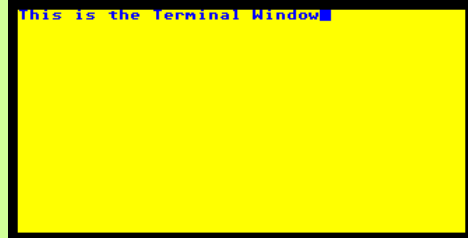

For the complete set of commands of the sample image [see p. 145](#).

Terminal window foreground/background colour

Small terminal window with 40 characters and 20 lines

Font colour blue, window colour yellow, non-transparent

`#YDC $0000FF,100,$FFFF00,100`

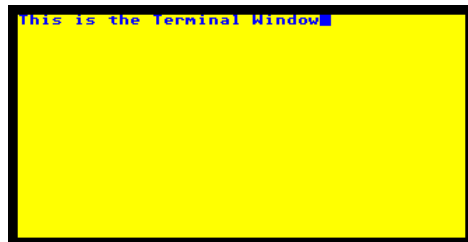

For the complete set of commands of the sample image [see p. 145](#).

TOUCH CONTROL OBJECTS/TOUCH CONTROL FUNCTIONS

Touch control zones

Rectangular touch button

Set touch control switch to position 400,240.

External dimensions are defined by the button style

#TSR 1, 1, "Normal"; "Pushed"; 400,240



For the complete set of commands of the sample image [see p. 146](#).

Elliptical touch button

Set touch control switch to position 400,240.

External dimensions are defined by the button style

#TSE 1, 1, "Normal"; "Pushed"; 400,240



For the complete set of commands of the sample image [see p. 146](#).

Touch button as an image

Use two images as a touch button

#TSP 1, 1, "Closed"; "Opened"; 400,240,7

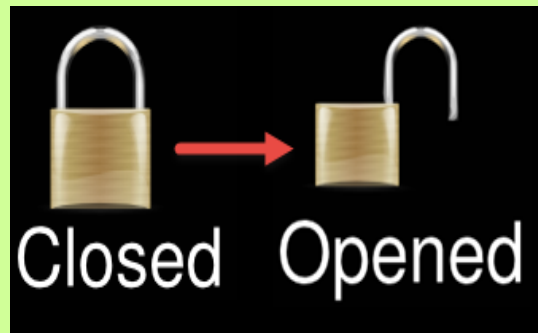

TIME

#WGC

Object group as a clock

Define Object Group 10 as a clock

Objects 6, 7 and 8 form the clock hands

#WGC 10, 6, 7, 8



For the complete set of commands of the sample image [see p. 147](#).

DRAWING/GRAPHIC PRIMITIVES

Rounded rectangle with border

Rounded rectangle with border

Rounded rectangle with border, a type of picture frame

[#GRR](#) 1,1,400,240,5,200,100,20,15

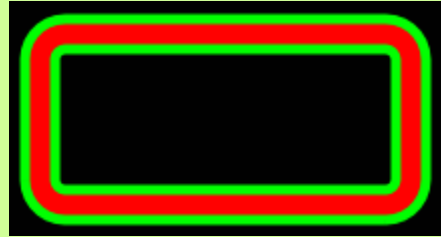

For the complete set of commands of the sample image [see p. 148](#).

Polyline - Santa Claus house

Draw a Santa Claus house with the aid of a polypath

[#GPL](#) 1,1,20,20,20,100,70,100,70,20,20,20,70,100,45,130,20,100,70,20



For the complete set of commands of the sample image [see p. 148](#).

Filled-in polyline - trapezium

Draw a filled-in trapezium with the aid of a polypath

[#GPF](#) 1,1,20,20,60,80,160,80,120,20

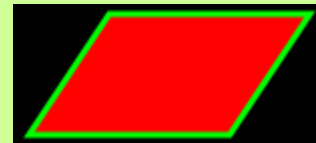

For the complete set of commands of the sample image [see p. 148](#).

Extend a polyline - Santa Claus house

Extend the Santa Claus house by the 3 dimensions

[#GPA](#) 1,1,20,20,20,100,70,100,70,20,20,20,70,100,45,130,20,100,70,20

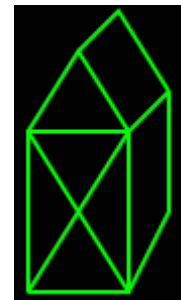

For the complete set of commands of the sample image [see p. 148](#).

Graphic drawing objects**Polypath - Draw a car**

Draw a car with path segments

#GPP 1,1, 50,200, ?v-50, ?h150, ?c0,70,130,0, ?h200, ?c0,70,130,0, ?h90,
?v100, ?h-85, ?l-40,65, ?h-220, ?q-40,0,-145,-75, ?h-130, ?z

Course of the relative polypath:

The line is drawn vertically, 50 pixels downwards from the starting point. A horizontal alignment then follows towards the right. The wheels are drawn between the three horizontal segments using segments of a circle. The wheels are drawn in such a way that their width amounts to 130 pixels. A vertical alignment by 100 pixels upwards follows, as well as a vertical line by 85 pixels to the left. For the rear windscreen, a line segment is used, which sets the end point to 40 pixels to the left and 65 pixels above the last position, and connects it by means of a line. A horizontal line to the left, having a length of 220 pixels, then follows. For the front windscreen, a quadratic Bezier segment is used. A horizontal line to the left with 130 pixels, as well as the end of the path, follows the-reafter.

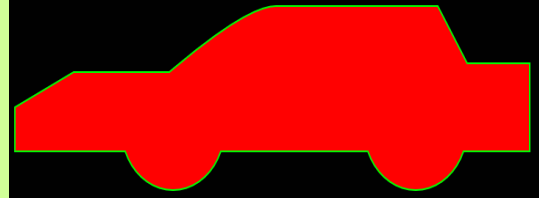

For the complete set of commands of the sample image [see p. 148](#).

Hexagon

A hexagon rotated through 90°

#GGP 1, 1 400,240,5, 100,6,0, 90

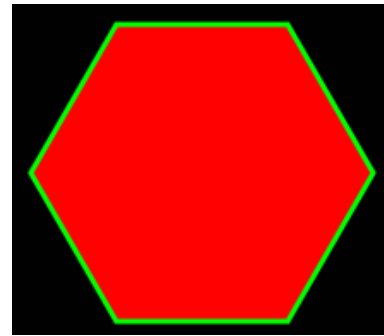

For the complete set of commands of the sample image [see p. 149](#).

Five-point star

Draw a filled-in star

#GGS 1, 1 400,240,5, 100,50, 5



For the complete set of commands of the sample image [see p. 149](#).

Graphic drawing objects

Tyres

A circle with a hole

#GET 1, 1 400,240,5, 100,100, 30

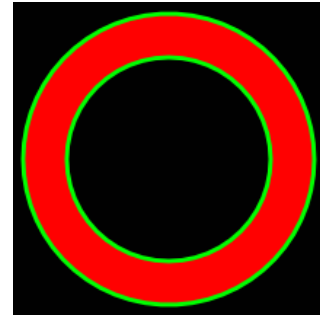

For the complete set of commands of the sample image [see p. 149](#).

Graphic drawing objects

Arc of a circle

Draw a letter "C" as an arc of a circle

#GEA 1, 1 400,240,5, 100,100, 45,-45, 30



For the complete set of commands of the sample image [see p. 149](#).

Cut segments of a circle

Draw two cut segments of a circle

#GES 1, 1, 400, 200, 5, 100, 100, 90, 0

#GES 2, 1, 450, 200, 5, 100, 100, 180, 60

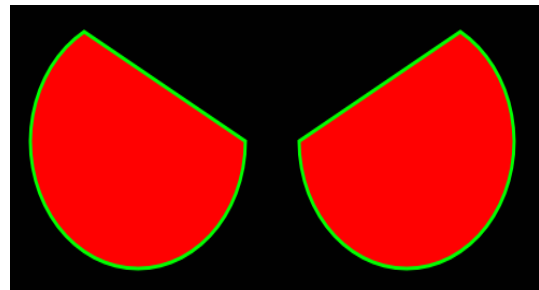

For the complete set of commands of the sample image [see p. 150](#).

Piece of cake

Draw a piece of cake

#GEP 1, 1 400,240,5, 100,100, 135,225

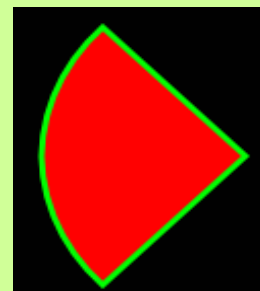

For the complete set of commands of the sample image [see p. 150](#).

SEGEMENTTYPEN

Segmente H(orizontal), V(ertikal), L(inear)

Polypfad Horizontal

Horizontale Linie als Polypfad erzeugen

#GPP 1, 1, 10, 50, ?H 300



For the complete set of commands of the sample image [see p. 151](#).

Polypfad Vertikal

Vertikale Linie als Polypfad erzeugen

#GPP 1, 1, 50, 50, ?V 150



For the complete set of commands of the sample image [see p. 151](#).

Polypfad Linie

Linie als Polypfad erzeugen

#GPP 1, 1, 50, 50, ?L 250, 100

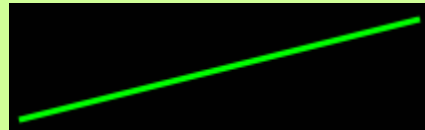

For the complete set of commands of the sample image [see p. 151](#).

Segmente C(ircle), E(llipse)

Polypfad Kreissegment

Kreissegment gegen den Uhrzeigersinn mit dem Radius 120. Der Radius muss mindestens Abstand/2 betragen

#GPP 1, 5, 200,200,?C0,120,400,200

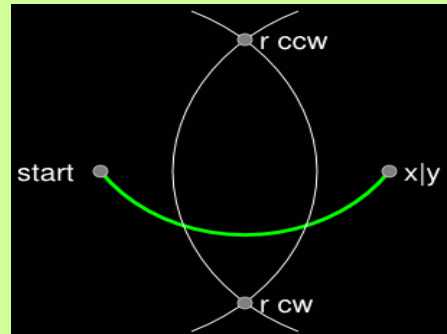

For the complete set of commands of the sample image [see p. 152](#).

Polypfad Ellipse

Ellipse durch die beiden Punkte

#GPP 1, 5, 200,300,?E,110,150,0,400,300

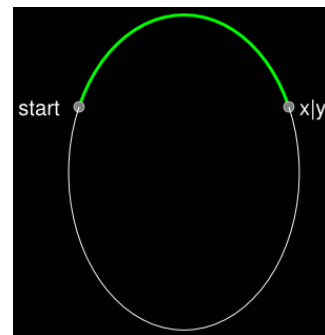

For the complete set of commands of the sample image [see p. 152](#).

Segmente Q(uadratische Bézier Kurve), R

Polypfad quadratische Bézierkurve

Eine quadratische Bézierkurve platzieren. Der Stützpunkt bestimmt die gezeichnete Kurve

#GPP 1, 5, 200,300,?Q 250, 200,400,300

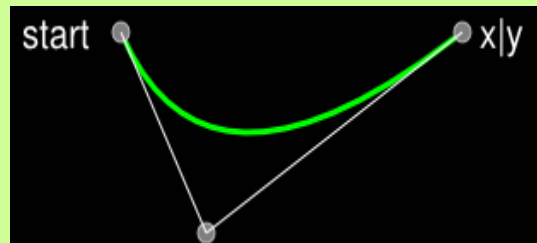

For the complete set of commands of the sample image [see p. 153](#).

Polypfad quadratische Bézierkurve mit Hilfspunkt

Eine quadratische Bézierkurve platzieren. Der Stützpunkt wird durch das vorher gezeichnete Segment vorgegeben (Punktspiegelung) Dadurch werden die einzelnen Segmente immer tangential Zusammengefügt und bilden eine geglätteten Übergang.

#GPP 1, 5, 200,300,?Q 210,200,300,300, ?R 460,300

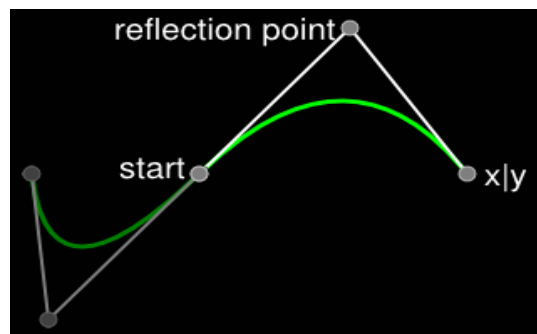

For the complete set of commands of the sample image [see p. 154](#).

Segmente T, S(pline)

Polypfad Spline

Spline zeichnen

#GPP 1, 5, 100,50,?S150,100,250,100,300,50

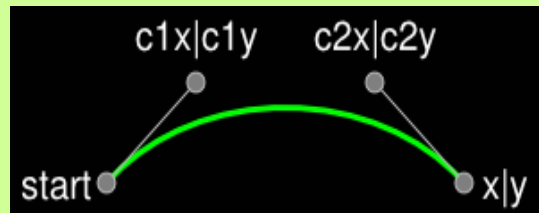

For the complete set of commands of the sample image [see p. 155.](#)

Polypfad geglättete kubische Bézierkurve

Die geglättete kubische Bézierkurve übernimmt von dem vorhergegangenen Pfad den letzten Stützpunkt und spiegelt diesen am Startpunkt der eigenen Kurve. Es ergibt sich so ein tangentialer also glatter Übergang zwischen beiden Segmenten.

#GPP 1, 5, 200,200, ?s-10,80,60,40,80,0, ?t70,-35,100,0

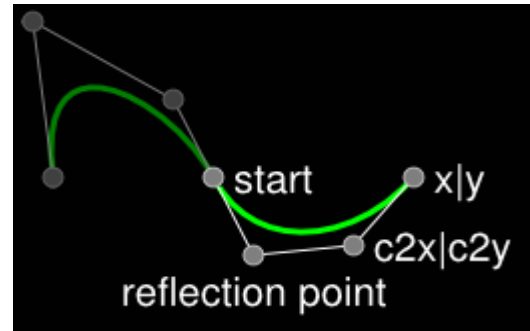

For the complete set of commands of the sample image [see p. 156.](#)

Segmente Z, M

Polypfad schließen

Nach Zeichnen der Ellipse wird der Polypfad geschlossen

#GPP 1, 5, 200,200, ?e1,100,70,0,200,0, ?Z

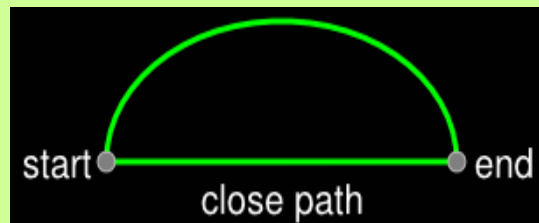

For the complete set of commands of the sample image [see p. 157.](#)

Polypfad Sprung

Platzierung eines Kreises in einem Rechteck, als ein Polypfadobjekt. Vor allem mit Füllung interessant

#GPP 1, 5, 200,200, ?h100, ?v100, ?h-100, ?Z, ?M250, 210, ?c1,40,0,80, ?c1,40,0,-80

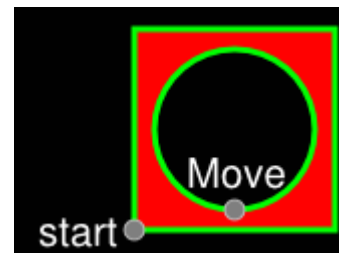



For the complete set of commands of the sample image [see p. 157.](#)

COMMANDS FOR THE EXAMPLES

The complete commands which are necessary for the creation of the sample images are shown below.

OPERATION AND ANIMATION

Opacity curve, colour offset curve
Opacity
Define square
#GRR 1, 1, 100,100,5, 80,80,5
Operation: change the alpha channel
#AOA 1, 501, 20
Define type of operation and time of operation
#AOT 1, 4, 500
Define white filling
#CFC 4, \$FFFFFF, 60
Create rectangles
#GRR 2, 4, 200,100,5, 80,80,5
#GRR 3, 1, 300,100,5, 80,80,5

Colour transformation
#CFC 4, \$7F7FFF, 60
Define square
#GRR 1, 1, 100,100,5, 80,80,5
Colour transformation operation Remove red and green portion
#AOA 1, 501, -100,-100
Define type of operation and time of operation
#AOT 1, 4, 500
Define remaining squares
#GRR 2, 4, 200,100,5, 80,80,5
#GRR 3, 1, 300,100,5, 80,80,5

Position Curve, Scale Curve

Operation path with change of position

Draw a straight line in order to visualise the operation path

```
#GPL 1, 2, 100, 100, 700, 200
      Insert a circle with a filling
#GET 2, 1, 100, 100, 5, 60
      Move operation via Path 1
#AOA 2, 101, 700, 200
      Define type of operation and time of operation
#AOT 2, 5, 500
      Set integer register
#VRI 0, 3, 1, 10
      Define white filling
#CFC 4, $FFFFFF, 60
      Define circles with filling, as well as their type of operation and time of
      operation
#GET R0, 4, 100, 100, 5, 60
#AOA R0, 101, 700, 200
#AOT (R0++), 5, 600, 100
#GET R0, 4, 100, 100, 5, 60
#AOA R0, 101, 700, 200
#AOT (R0++), 5, 700, 200
#GET R0, 4, 100, 100, 5, 60
#AOA R0, 101, 700, 200
#AOT (R0++), 5, 800, 300
#GET R0, 4, 100, 100, 5, 60
#AOA R0, 101, 700, 200
#AOT (R0++), 5, 900, 400
```

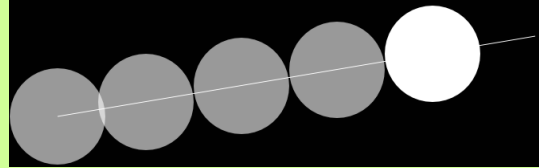

Changing the size

Insert a circle with a filling

```
#GET 1, 1, 200, 200, 5, 50
      Double the size of the operation
#AOA 1, 201, 200, 200
      Define type of operation and time of operation
#AOT 1, 5, 500, 0
      Define white filling
#CFC 4, $FFFFFF, 60
      Set integer register
#VRI 0, 3, 500, 1, 300
      Generate circles and define their type of operation, as well as time of
      operation
#GET R0, 4, 200, 200, 5, 50
#AOA R0, 201, 200, 200
#AOT (R0++), 5, (R1+R2*R3), (R2++*R3)
#GET R0, 4, 200, 200, 5, 50
#AOA R0, 201, 200, 200
#AOT (R0++), 5, (R1+R2*R3), (R2++*R3)
#GET R0, 4, 200, 200, 5, 50
#AOA R0, 201, 200, 200
#AOT (R0++), 5, (R1+R2*R3), (R2++*R3)
#GET R0, 4, 200, 200, 5, 50
#AOA R0, 201, 200, 200
#AOT (R0++), 5, (R1+R2*R3), (R2++*R3)
```

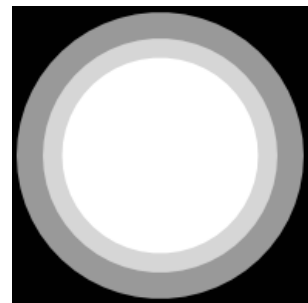

Position Curve, Scale Curve

Changing the size and position

Add an ellipse polypath in order to visualise the operation path

#GPP 1, 2, 400, 80 ?E0, 300, 150, 0, 400, 380 ?E0, 300, 150, 0, 400, 80

Insert a circle with a filling

#GET 2, 1, 400, 80, 5, 60

Define operational path of ellipse The path corresponds to Object 1

#APD 1, 400, 80 ?E0, 300, 150, 0, 400, 380 ?E0, 300, 150, 0, 400, 80

Operation path: Change size

#APD 2, 100, 100 ?L, 30, 30 ?L, 100, 100

Operation: Moving and changing the size

#AOA 2, 151, 1, 0, 251, 2, 0

Define type of operation and time of operation

#AOT 2, 1, 400

Set integer register

#VRI 0, 3, 1, 10

Define white filling

#CFC 4, \$FFFFFF, 70

Set macro file mark

#MFM

Create dots/circles

#GET R0, 4, 400, 80, 5, 60

Operation: Moving and changing the size

#AOA R0, 151, 1, (R1*R2), 251, 2, (R1++*R2)

Define type of operation and time of operation

#AOT R0, 1, 400

Jump back to the macro file mark

#MFJ (R0++<20)

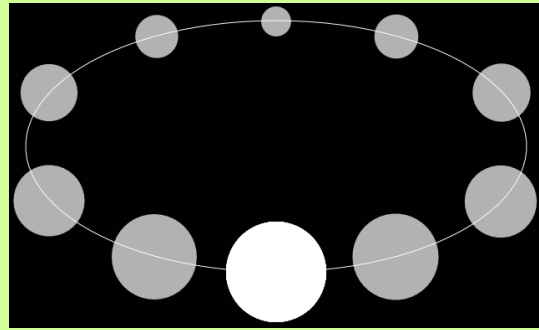

Rotation

Define rectangle as being horizontal

#GRR 1, 1, 50, 100, 4, 300, 40, 5

Operation: Rotate by 90° anti-clockwise.

#AOA 1, 301, 90

Define type of operation and time of operation

#AOT 1, 4, 500

Set integer register

#VRI 0, 2, 1, 100

Define white filling

#CFC 4, \$FFFFFF, 70

Set macro file mark

#MFM

Create rectangles

#GRR R0, 4, 50, 100, 4, 300, 40, 5

Operation: Rotate by 90° anti-clockwise.

#AOA R0, 301, 90

Define type of operation and time of operation

#AOT R0, 1, 400

Jump back to the macro file mark

#MFJ (R0++<20)



Position Curve, Scale Curve

Elliptical operation path with change of position

Insert an ellipse polypath in order to visualise the operation path

#GPP 1, 2, 400, 80 ?E0, 300, 150, 0, 400, 380 ?E0, 300, 150, 0, 400, 80

Insert a circle with a filling

#GET 2, 1, 400, 80, 5, 60

Define ellipse and line operation path. The path corresponds to Object 1

#APD 1, 400, 80 ?E0, 300, 150, 0, 400, 380 ?E0, 300, 150, 0, 400, 80

Operation: Move object via Path 1

#AOA 2, 151, 1, 0

Define type of operation and time of operation

#AOT 2, 1, 400

Define white filling

#CFC 4, \$FFFFFF, 70

Set integer register

#VRI 0, 3, 1, 20

Define circles with type of operation and time of operation

#GET R0, 4, 400, 80, 5, 60

#AOA R0, 151, 1, (R1++*R2)

#AOT (R0++), 1, 100

#GET R0, 4, 400, 80, 5, 60

#AOA R0, 151, 1, (R1++*R2)

#AOT (R0++), 1, 100

#GET R0, 4, 400, 80, 5, 60

#AOA R0, 151, 1, (R1++*R2)

#AOT (R0++), 1, 100

#GET R0, 4, 400, 80, 5, 60

#AOA R0, 151, 1, (R1++*R2)

#AOT (R0++), 1, 100

#GET R0, 4, 400, 80, 5, 60

#AOA R0, 151, 1, (R1++*R2)

#AOT (R0++), 1, 100

#GET R0, 4, 400, 80, 5, 60

#AOA R0, 151, 1, (R1++*R2)

#AOT (R0++), 1, 100

#GET R0, 4, 400, 80, 5, 60

#AOA R0, 151, 1, (R1++*R2)

#AOT (R0++), 1, 100

#GET R0, 4, 400, 80, 5, 60

#AOA R0, 151, 1, (R1++*R2)

#AOT (R0++), 1, 100

#GET R0, 4, 400, 80, 5, 60

#AOA R0, 151, 1, (R1++*R2)

#AOT (R0++), 1, 100

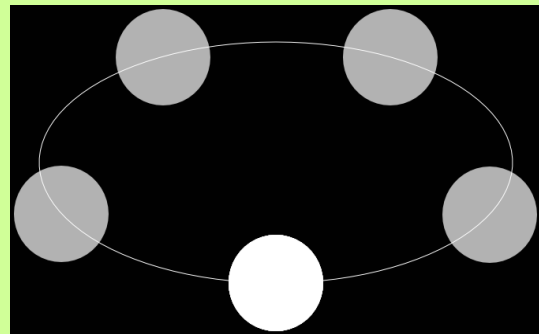

Position Curve, Scale Curve

Changing the rotation and position

Insert an ellipse polypath in order to visualise the operation path

#GPP 1, 2, 400, 80 ?E0, 300, 150, 0, 400, 380 ?E0, 300, 150, 0, 400, 80

Insert a circle with a filling

#GRR 2, 1, 400, 80, 5, 20, 100, 2

Define operational path of ellipse. The path corresponds to Object 1

#APD 1, 400, 80 ?E0, 300, 150, 0, 400, 380 ?E0, 300, 150, 0, 400, 80

Move operation along the path, revolving

#AOA 2, 151, 1, 0, 351, 1, 0

Define type of operation and time of operation

#AOT 2, 1, 400

Set integer register

#VRI 0, 3, 1, 10

Define white filling

#CFC 4, \$FFFFFF, 70

Set macro file marker

#MFM

Create rectangles

#GRR R0, 4, 400, 80, 5, 20, 100, 2

Move operation along the path, revolving

#AOA R0, 151, 1, (R1*R2), 351, 2, (R1++*R2)

Define type of operation and time of operation

#AOT R0, 1, 400

Jump back to the macro file marker

#MFJ (R0++<20)

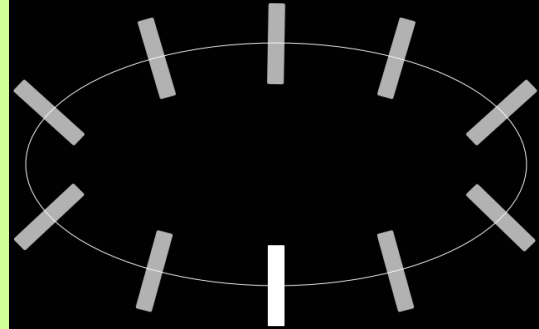

Distort

Define square

#GRR 1, 1, 100, 100, 5, 80, 80, 5

Shearing operation 40° on both axes

#AOA 1, 401, 40, 40

Define type of operation and time of operation

#AOT 1, 4, 500

Set integer register

#VRI 0, 2, 1, 200

Define white filling

#CFC 4, \$FFFFFF, 70

Set macro file marker

#MFM

Create rectangles

#GRR R0, 4, 100, 100, 5, 80, 80, 5

Shearing operation 40° on both axes

#AOA R0, 401, 40, 40

Define type of operation and time of operation

#AOT R0, 4, (500+R1*R2), (R1++*R2)

Jump back to the macro file marker

#MFJ (R0++<3)



INSTRUMENTS

#IBT, IBR, IVA, IPP, IBA, IGM, IGS

```

Triangular bar graph
  Define green colour gradient
#CCR 1, 0, $005f00, 100, 50, $00Bf00, 100, 100, $005f00, 100
  Refrain from defining an outline
#CLD 1
  Define monochrome blue filling
#CFC 2, $008dd3, 100
  Define line style for outline
#CLS 2, $ffff, 100, 2
  Define colour gradient as linear with 90° torsion
#CFL 1, 1, 90,
  Bar graph with green gradient as a foreground. Background plain blue.
  As an indication, the three possible positions of the point have been high-
  lighted
#IBT 1, 1, 2, 150, 70, 4, 300, 100
  Set bar graph to the value 70.
#IVS 1, 70
  Define line style for points
#CLS 5,$FF0000,100,3
  Define blue filling for points
#CFC 5,$0000FF,100
  Define yellow filling for font
#CFC 6,$FFFF00,100
  Refrain from defining an outline for font
#CLD 6
  Define text style
#CTF 2,</Projekt/Font/Arialbd.evf>,40,1,6
  Set integer register
#VRI 0,1
  String Register setzen
#VSS 1,"1"
  Set string register
#VSS 4,"2"
  Set string register
#VSS 7,"0"
  Set marker for macro file
#MFM
  Create points
#GET (10+R0),5,(objX(1,R0)),(objY(1,R0)),5,5
  Generate numbering
#SSP (100+R0),2,(objX(1,R0)-15),(objY(1,R0)),6,T0
  Set integer register
#VRI 0, (R0+3)
  Command serves to jump to the marker of the macrofile again
#MFJ (R0<9)
  Set numbering
#SSP (100+R0),2,(objX(1,1)),(objY(1,1)+20),9,"TIP"
  
```

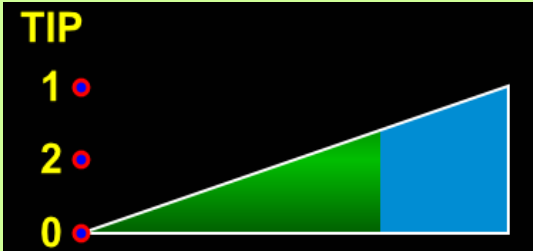

#IBT, IBR, IVA, IPP, IBA, IGM, IGS

Bar graph with rounded corners

Define green colour gradient

#CCR 1, 0, \$005f00, 100, 50, \$00Bf00, 100, 100, \$005f00, 100

Refrain from defining an outline

#CLD 1

Define monochrome blue filling

#CFC 2, \$008dd3, 100

Define line style for outline

#CLS 2, \$ffffff, 100, 2

Define colour gradient as linear with 90° torsion

#CFL 1, 1, 90,

Rectangular bar, with start and end value, adjusted to seconds

#IBR 1, 1, 2, 150, 70, 4, 300, 50, 15

Change bar automatically with the second

#IVS 1,70



Bar graph value update

Define green colour gradient

#CCR 1, 0, \$005f00, 100, 50, \$00Bf00, 100, 100, \$005f00, 100

Refrain from defining an outline

#CLD 1

Define monochrome blue filling

#CFC 2, \$008dd3, 100

Define line style for outline

#CLS 2, \$ffffff, 100, 2

Define colour gradient as linear with 90° torsion

#CFL 1, 1, 90,

Rectangular bar, with start and end value, adjusted to seconds

#IBR 1, 1, 2, 150, 70, 4, 300, 50, 15,0,59

Change bar automatically with the second

#IVA 1,(second())

Define monochrome white filling for label

#CFC 3, \$FFFFFF,100

Refrain from defining an outline for the font

#CLD 3

Change text style

#CTC 1,3

Place the calculated string in the centre of the object

#SAP 2,1, (objX(1,5)), (objY(1,5)),5, "%d"; (second())



Wattmeter as an instrument

Specify project path absolutely

#XPS </Projekt>

Place instrument file; original image size, start value =0, end value =500

#IPP 1, "Wattmeter"; 400,200,5,0,0,0,500

Set bar graph to 70% (0.7x500)

#IVS 1, 350



#IBT, IBR, IVA, IPP, IBA, IGM, IGS

Arc - bar graph

Define green colour gradient

#CCR 1, 60, \$005f00, 100, 70, \$00Bf00, 100, 100, \$005f00, 100

Refrain from defining an outline

#CLD 1

Define monochrome blue filling

#CFC 2, \$008dd3, 100

Define line style for outline

#CLS 2, \$ffffff, 100, 2

Define colour gradient as being radial

#CFR 1, 1

Bar graph with green gradient clockwise as a foreground. Background plain blue.

#IBA 1, 1, 2, 150, 70, 4, 300, 45, 45, 135

Set bar graph to the value 70.

#IVS 1, 70

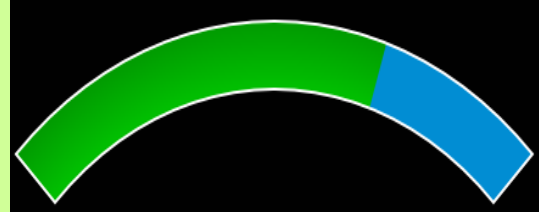

Object group as a rotational instrument

Define line style and filling of hands

#CLS 2, \$000000

#CFC 2, \$FF0000

Define line style and filling of point and disc

#CLS 3, \$000000

#CFC 3, \$FFFFFF

Generate disk and hands

#GES 1, 3, 300, 116, 8, 270, 270, 0, 180

#GPF 2, 2, 0, 0, 30, 280, 60, 0

Turn hands, set and place free anchor

#ORA 90, 2

#OAO 30, 20, 2

#OPA 300, 116, 2

Generate white point

#GET 3, 3, 270, 116, 5, 10

Generate group and define it as a rotational instrument

#OGA 5, 1, 2, 3, 4

#IGM 5, 2, 180, -180, -90, 90

Assign touch function

#TID 1, 5

Place calculated string

#SAP 4, 1, 310, 10, 9, "%d°"; (objIV(5))

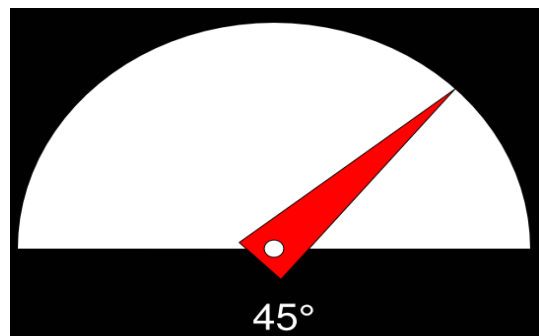

#IBT, IBR, IVA, IPP, IBA, IGM, IGS

Object group as a slider

```

Define green colour gradient
#CCR 1, 0, $005f00, 100, 50, $00Bf00, 100, 100, $005f00, 100
Refrain from defining a line style and colour gradient distorted by 90°
#CLD 1
#CFL 1, 1, 90
Define blue filling and white line style for bar graph
#CFC 2, $008dd3, 100
#CLS 2, $ffffff, 100, 2
Define line style for slider path
#CLS 3, $606060, 100, 5
Refrain from defining a line style and red filling for slider
#CLD 4
#CFC 4, $A50000, 100
Place slider with path line
#GPL 1, 3, 425, 60, 425, 245
#GRR 2, 4, 425, 60, 5, 60, 15, 15, 0
Generate group and define it as a slider.
#OGA 3, 1, 2
#IGS 3, 1, 2, 0, 0, 100
Place bar graph
#IBR 4, 1, 2, 50, 70, 4, 300, 50, 15
Assign touch function
#TID 1, 3
Place calculated and fixed string
#SAP 5, 1, 490, 145, 5, "%d°"; (objIV(3))
#SSP 6, 1, 425, 35, 5, "0"
Automatic change in value in the bar graph
#IVA 4, (objIV(3))
  
```

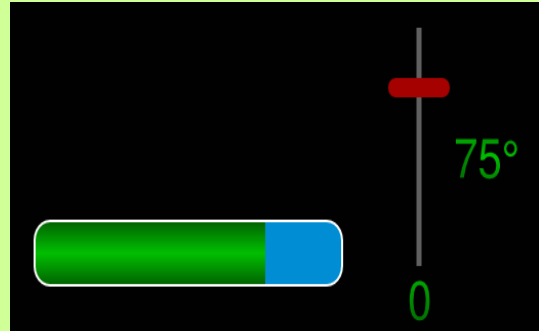

KEYBOARD

#KDB, KDL, KDC, KPK

Place object group as a keyboard

Define line styles, colour gradient and fillings for keys

#CLD 11
#CFC 11, \$FFFFFF, 100
#CLD 12
#CFC 12, \$00FF00, 100
#CCR 1, 0, \$0000FF, 100, 80, \$5555FF, 100, 100, \$0000FF, 100
#CFL 15, 1, 90
#CLS 15, \$555555, 100, 1
#CFL 16, 1, 270
#CLS 16, \$555555, 100, 1

Define text styles

#CTF 11, <l:Sans.evf>;34, 1, 11
#CTF 12, <l:Sans.evf>;34, 1, 12
#CTF 13, <l:Sans.evf>;18, 1, 11
#CTF 14, <l:Sans.evf>;18, 1, 12

Define text styles for touch buttons

#CBT 1, 11, 12, 0, -5
#CBT 2, 13, 14, 0, -2

Define drawing style and change in proportion of the touch button

#CBD 1, 15, 16, 100, 50, 10
#CBD 2, 15, 16, 100, 50, 10
#CBO 1, 0, 0, 140
#CBO 2, 0, 0, 100

Define keyboard style

#KDC 5, 5, 1, 2

Define keyboard fields

#KDB 5, 1, "^1234567890ß\8\C"; "\6qwertzuiopü+|\D\D"; "\5asdfghjklöä#\N"; "<yxcvbnm,-.;" " "
#KDB 5, 2, "!"\$%&/()=?\8\C"; "\6QWERTZUIOPÜ*\D\D"; "\5ASDFGHJKLÖÄ#\N"; ">YXCVBNM;:_;" " "

Change labelling of the special keys

#KDL 5, 5 "Shift"; 6 "Caps"; 8 "Back"; 12 "Clear"; 13 "Return"

Place keyboard

#KPK 5, 0, 0, 7, 800

Fill in frames of the object group/keyboard

#CLD 42
#CFC 42, \$FFFFFF, 20
#OFP 42, 10, 10, 5

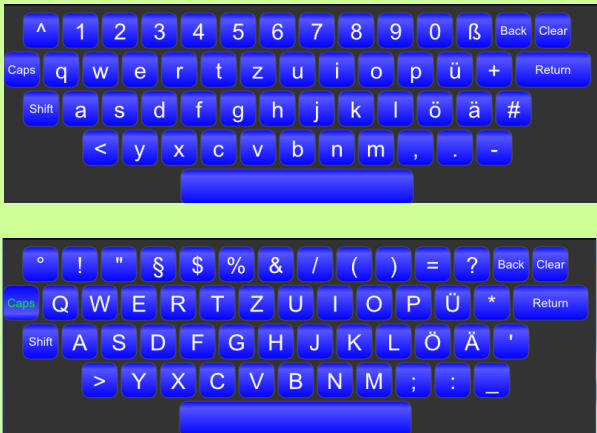

CHARACTER STRING COMMANDS IN A STRING

#SDP, SEP, SEK, SEA

Date and time

Placing a formatted date

#SDP 1, 1, 50, 50, 17, "%W the %D. %3N %Y, %1h:%m"

Changing the formatted date

#SDC 1, (datetime(11, 37, 0, 21, 4, 2016))

Thursday the 21. Apr 2016, 11:37

Edit box in combination with a keyboard

Define text style for the keyboard

#CLD 1

#CFC 1, \$FFFF00, 100

#CTF 1, <l:Sans.evf>;30, 1 11

Define filling for the keyboard for the pressed-down and not pressed down state

#CCR 1, 0, \$0000FF, 100, 80, \$5555FF, 100, 100, \$0000FF, 100

#CFL 3, 1, 90

#CLS 3, \$555555, 100, 1

#CFL 4, 1, 270

#CLS 4, \$555555, 100, 1

Define touch button style

#CBT 2, 1, 1, 0, 0

#CBD 2, 3, 4, 100, 50, 25

#CBO 2, 0, 0, 150

Define and place keyboard

#KDC 9, 2, 2

#KDB 9, 1, "ABCDE";"FGHIJ";"KLMNO";"PQRST";"UVWXY";"Z "

#KPK 9, 400, 10, 8, 0, 250

Define border, filling and text style of the edit box

#CLS 20, \$FFFF00, 100, 2

#CFC 20, \$0000FF, 100

#CLD 21,

#CFC 21, \$FFFFFF, 100

#CTF 21, <l:Sans.evf>;30, 2, 21

#CTF 22, <l:Sans.evf>;30, 1, 21

#CTF 23, <l:Sans.evf>;30, 0, 21

Place edit boxes

#SEP 6, 20, 400, 280, 8, 300, 50, 6, 21, -5, -3

#SEP 7, 20, 400, 340, 8, 300, 50, 6, 22, 0, -3

#SEP 8, 20, 400, 400, 8, 300, 50, 6, 23, 5, -3

Combine edit boxes and keyboard in one group

#OGA 91, 6-9

Allocate edit boxes to the keyboard and enable Edit Box 8

#SEK 9, 6-8

#SEA 8

Allocate touch function for selecting the edit boxes by touch control

#TID 1, 6-8

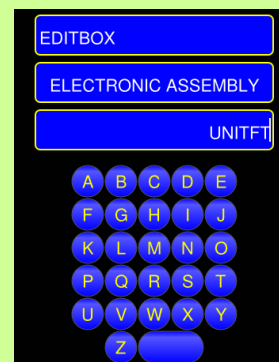

STYLE SHEETS

Colour gradient and dash pattern(s)

Colour gradient
Define colour gradient
#CCR 1, 0,\$FF0000,100, 50,\$00FF00,70, 100,\$0000FF,100
Define colour gradient as being linear
#CFL 1, 1,
Refrain from defining any line style
#CLD 1
Create square
#GRR 1,1, 50,50,7,200,100



Dash pattern(s)
Define a dash pattern
#CDP 1, 0, 20,10, 5,10
Define line style
#CLS 1, \$00FF00,100, 5,0 1
Refrain from defining a filling
#CFD 1
Draw a polyline
#GPL 1,1, 50,50,400,50



Fillings

Monochrome filling

Define a background colour, wherein the alpha channel is optional

#CFC 1, \$00FF00

Refrain from defining any line style

#CLD 1

Create square

#GRR 1,1, 50,50,7,200,100

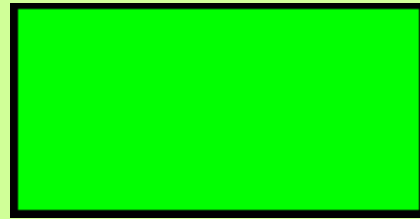

Linear colour gradient filling

Define colour gradient

#CCR 1, 0,\$FF0000,100, 50,\$00FF00,70, 100,\$0000FF,100

Define colour gradient as being linear and inclined at an angle of 45°

#CFL 1, 1, 45

Refrain from defining any line style

#CLD 1

Create square

#GRR 1,1, 50,50,7,200,200

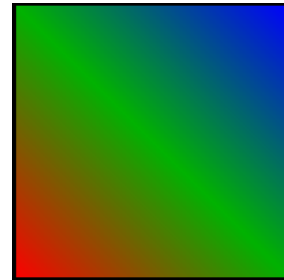

Radial colour gradient filling

Define colour gradient

#CCR 1, 0,\$FF0000,100, 50,\$00FF00,70, 100,\$0000FF,100

Define colour gradient as being radial

#CFR 1, 1, 5000,5

Refrain from defining any line style

#CLD 1

Create square

#GRR 1,1, 50,50,7,200,200

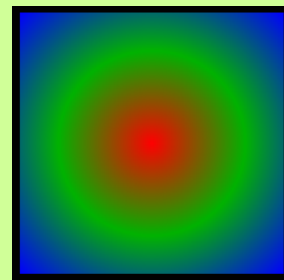

Conical colour gradient filling

Define colour gradient

#CCR 1, 0,\$FF0000,100, 33,\$00FF00,70, 66,\$0000FF,100, 100, \$FF0000,100

Define colour gradient as being conical

#CFK 1, 1, 5000,5

Refrain from defining any line style

#CLD 1

Create square

#GRR 1,1, 50,50,7,200,200

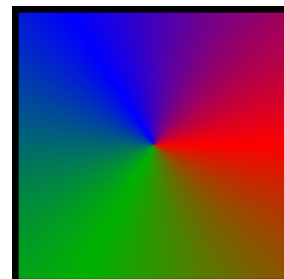

Pattern filling

Filling with a recurrent pattern

#CFP 1, "marmor02"

Refrain from defining any line style

#CLD 1

Create square

#GRR 1,1, 50,50,7,200,200

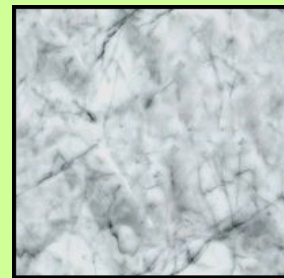

Linen style

Line colour and thickness

Green line with a thickness of 5 pixels

```
#CLS 1, $00FF00, 100, 5
```



Line joint style

Refrain from defining any line style

```
#CLD 1
```

Define filling font

```
#CFC 1, $FFFFFF, 100
```

Define text style

```
#CTF 1, <!:Sans.evf>, 58, 0, 1, 0, 1, 0
```

Refrain from defining an outline

```
#CFD 4
```

Define green line style as being angular

```
#CLS 4 $00FF00, 100 10, 0
```

Refrain from defining an outline

```
#CFD 5
```

Define green line style as being round

```
#CLS 5 $00FF00, 100 10, 1
```

Set integer register

```
#VRI 0, 50, 50, 20, 50
```

Draw a polypath and place string

```
#GPL 1, 4, R0, R3, (R0+R1), (R3+R2) rd, R0, (R3+2*R2)
```

```
#SSP 2, 1, (R0+R1+20), (R3+R2), 4, "Miter"
```

Set integer register

```
#VRI 3, (R3+3*R2)
```

Draw a polypath and place string

```
#GPL 3, 5, R0, R3, (R0+R1), (R3+R2), R0, (R3+2*R2)
```

```
#SSP 4, 1, (R0+R1+20), (R3+R2), 4, "Round"
```



Text style

Text style

Creating a text style with the internal font "Sans"

```
#CTF 1, <!:Sans.evf>, 60, 1, 1
```

Place string

```
#SSP 1, 1, 200, 50, 7, "Hello World"
```

Hello World

Button style

Touch button as an image

Define two images as a touch button

#CBP 1, "Padlock_closed"; "Padlock_opend"

Define text style for touch button

#CBT 1, 1, 1, -10, -70

Define images for touch button

#TSP 1, 1, "Closed"; "Opened"; 400, 240, 7

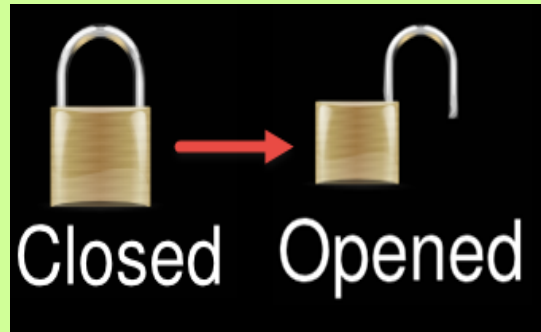

Change touch button proportion upon pressing it

Change text orientation

#CTA 1, 1

Generate colour gradients for touch button

#CCR 5, 0, \$00007F, 100, 50, \$0000FF, 100, 100, \$00007F, 100

#CCR 6, 0, \$7F7F00, 100, 50, \$FFFF00, 100, 100, \$7F7F00, 100

Create line styles for touch button

#CLS 5, \$FFFFFF, 100, 1

#CLS 6, \$FFFFFF, 100, 1

Rotate colour gradients by 90°

#CFL 5, 5, 90

#CFL 6, 6, 90

Define touch button style

#CBD 1, 5, 6, 200, 50, 10

Define text style for touch button

#CBT 1, 1, 1

Change proportion in the pressed state

#CBO 1, 0, 0, 70

Define squarish touch button

#TSR 1, 1, "Normal"; "Pushed"; 400, 240, 5



TERMINAL COMMANDS

Terminal window

(Re-)define terminal window

Font colour blue, window colour yellow, non-transparent

#YDC \$0000FF,100,\$FFFF00,100



Small terminal window with 40 characters and 20 lines

#YDW 1,30,30,7,40,20



This is the Terminal Window

TOUCH CONTROL OBJECTS/TOUCH CONTROL FUNCTIONS

Touch control zones	
Rectangular touch button	
	Change text orientation
#CTA	1,1
	Define touch button colour gradients for normal and pressed down states
#CCR	5, 0,\$00007F,100, 50,\$0000FF,100, 100,\$00007F,100
#CCR	6, 0,\$7F7F00,100, 50,\$FFFF00,100, 100,\$7F7F00,100
	Define touch button line style for normal and pressed down states
#CLS	5, \$FFFFFF,100,1
#CLS	6, \$FFFFFF,100,1
	Define touch button colour gradients as being linear with 90° torsion
#CFL	5,5,90
#CFL	6,6,90
	Define touch button style
#CBD	1, 5,6, 200,50,10
	Define touch button text style
#CBT	1, 1,1
	Define touch button change in proportion for pressed down state
#CBO	1,0,0,0
	Set elliptical touch button to position 400,240.
#TBR	1, 1, "Normal"; "Pushed"; 400,240
	
Elliptical touch button	
	Change text orientation
#CTA	1,1
	Define touch button colour gradients for normal and pressed down states
#CCR	5, 0,\$00007F,100, 50,\$0000FF,100, 100,\$00007F,100
#CCR	6, 0,\$7F7F00,100, 50,\$FFFF00,100, 100,\$7F7F00,100
	Define touch button line style for normal and pressed down states
#CLS	5, \$FFFFFF,100,1
#CLS	6, \$FFFFFF,100,1
	Define touch button colour gradients as being linear with 90° torsion
#CFL	5,5,90
#CFL	6,6,90
	Define touch button style
#CBD	1, 5,6, 200,50,10
	Define touch button text style
#CBT	1, 1,1
	Define touch button change in proportion for pressed down state
#CBO	1,0,0,0
	Set elliptical touch button to position 400,240.
#TSE	1, 1, "Normal"; "Pushed"; 400,240
	

TIME

#WGC

Object group as a clock

Refrain from defining a line style and white filling for hour hand
[#CLD](#) 11
[#CFC](#) 11, \$FFFFFF, 100
 Refrain from defining a line style and grey filling for minute hand
[#CLD](#) 12
[#CFC](#) 12, \$E0E0E0, 100
 Refrain from defining a line style and red filling for second hand
[#CLD](#) 13
[#CFC](#) 13, \$FF0000, 100
 Create colour gradient
[#CCR](#) 9, 0,\$0,100 100, \$A0A0A0, 100
 Define colour gradient and no line style for connecting point
[#CFR](#) 14, 9
[#CLD](#) 14
 Set integer register
[#VRI](#) 1,(scrW()/2),(scrH()/2)
 Place graphic of the dial
[#PPP](#) 5, "Clock3"; R1, R2, 5, 200
 Place the three hands and connecting point
[#GPF](#) 6, 11, 0, 0, 4, 75, 8, 0
[#GPF](#) 7, 12, 0, 0, 4, 95, 8, 0
[#GRR](#) 8, 13, 0, 0, 7, 2, 95
[#GET](#) 9, 14, R1, R2, 5, 7
 Define free anchors for hands
[#OAO](#) 4, 15, 6-7
[#OAO](#) 1, 20, 8
 Change the position of the hands absolutely
[#OPA](#) R1, R2, 6-8
 Create object group
[#OGA](#) 10, 5-9
 Define object group as a clock
[#WGC](#) 10, 6, 7, 8



DRAWING/GRAPHIC PRIMITIVES

Graphic drawing objects

Rounded rectangle with border

Define line style

#CLS 1, \$00FF00,100, 5

Define filling

#CFC 1, \$FF0000,100

Rounded rectangle with border, a type of picture frame

#GRR 1,1, 400,240,5, 200,100,20, 15

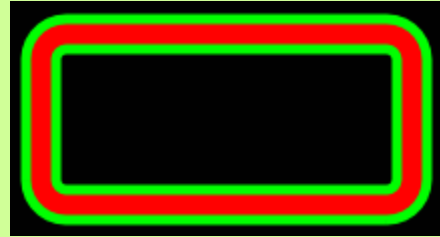

Polyline - Santa Claus house

Define line style

#CLS 1, \$00FF00,100, 2

Refrain from defining a filling

#CFD 1

Draw a Santa Claus house with the aid of a polypath

#GPL 1,1,20,20, 20,100, 70,100, 70,20, 20,20, 70,100, 45,130, 20,100, 70,20



Filled-in polyline - trapezium

Define line style

#CLS 1, \$00FF00,100, 3

Define filling

#CFC 1, \$FF0000,100

Draw a filled-in trapezium with the aid of a polypath

#GPF 1,1, 20,20, 60,80, 160,80, 120,20

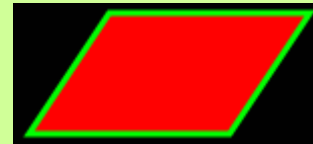

Extend a polyline - Santa Claus house

Define line style

#CLS 1, \$00FF00,100, 2

Refrain from defining a filling

#CFD 1

Draw a Santa Claus house with polypath from lines

#GPL 1,1, 20,20, 20,100, 70,100, 70,20, 20,20, 70,100, 45,140, 20,100, 70,20

Extend the Santa Claus house by the 3rd dimension

#GPA 1, 1,20,20, 20,100, 70,100, 70,20, 20,20, 70,100, 45,130, 20,100, 70,20

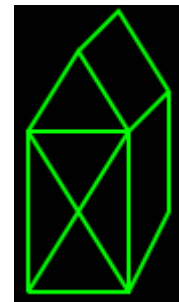

Polypath - Draw a car

Define line style

#CLS 1, \$00FF00,100, 2

Define filling

#CFC 1, \$FF0000,100

Draw a car using path segments

#GPP 1,1, 50,200, ?v-50, ?h150, ?c0,70,130,0, ?h200, ?c0,70,130,0, ?h90, ?v100, ?h-85, ?l-40,65, ?h-220, ?q-40,0,-145,-75, ?h-130, ?z

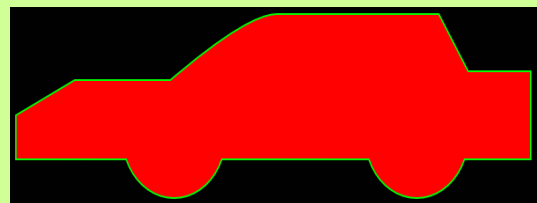

Graphic drawing objects

Hexagon

Define line style

#CLS 1, \$00FF00,100, 3

Define filling

#CFC 1, \$FF0000,100

A hexagon rotated by 90°

#GGP 1, 1 400,240,5, 100,6,0, 90

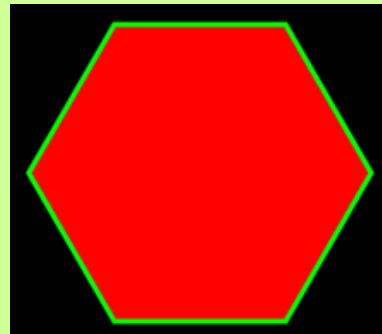

Five-point star

Define line style

#CLS 1, \$00FF00,100, 3

Define filling

#CFC 1, \$FF0000,100

Draw a filled-in star

#GGS 1, 1 400,240,5, 100,50, 5



Tyres

Define line style

#CLS 1, \$00FF00,100, 3

Define filling

#CFC 1, \$FF0000,100

Draw a circle with a hole

#GET 1, 1 400,240,5, 100,100, 30

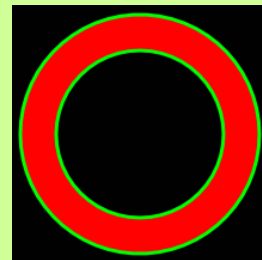

Arc of a circle

Define line style

#CLS 1, \$00FF00,100, 3

Define filling

#CFC 1, \$FF0000,100

Draw a letter "C" as an arc of a circle

#GEA 1, 1 400,240,5, 100,100, 45,-45, 30



Graphic drawing objects

Cut segments of a circle

Define line style

[#CLS](#) 1, \$00FF00, 100, 3

Define filling

[#CFC](#) 1, \$FF0000, 100

Draw two cut segments of a circle

[#GES](#) 1, 1, 400, 200, 5, 100, 100, 90, 0

[#GES](#) 2, 1, 450, 200, 5, 100, 100, 180, 60

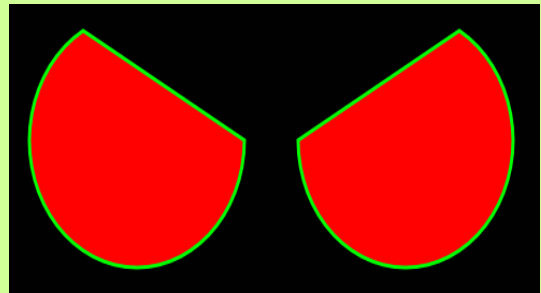

Piece of cake

Define line style

[#CLS](#) 1, \$00FF00, 100, 3

Define filling

[#CFC](#) 1, \$FF0000, 100

Draw a piece of cake

[#GEP](#) 1, 1 400, 240, 5, 100, 100, 135, 225

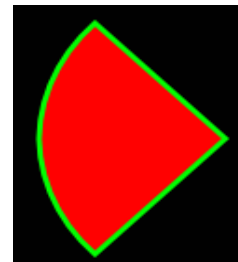

SEGEMENT TYPES

Segments H(orizontal), V(ertical), L(inear)

Horizontal polypath
Define line style
[#CLS](#) 1, \$00FF00,100, 3
Refrain from defining an outline
[#CFD](#) 1
Generate a horizontal line as a polypath
[#GPP](#) 1, 1, 10, 50, ?H 300



Vertical polypath
Define line style
[#CLS](#) 1, \$00FF00,100, 3
Refrain from defining a filling
[#CFD](#) 1
Generate a vertical line as a polypath
[#GPP](#) 1, 1, 50, 50, ?V 150

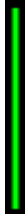

Line polypath
Define line style
[#CLS](#) 1, \$00FF00,100, 3
Refrain from defining an outline
[#CFD](#) 1
Generate a line as a polypath
[#GPP](#) 1, 1, 50,50, ?L 250,100



Segmente C(ircle), E(llipse)

Circle segment polypath

```

Define green line style
#CLS 5, $00FF00, 100, 3
Refrain from defining a filling
#CFD 5
Define grey line style
#CLS 6, $BFBFBF, 100, 1
Define a grey filling
#CFC 6, $7F7F7F, 100
Draw a polypath as a circle segment
#GPP 1, 5, 200, 200, ?C0, 120, 400, 200
Create dots/circles
#GET 2, 6, 200, 200, 5, 5
#GET 3, 6, 400, 200, 5, 5
#GET 6, 6, 300, 311, 5, 5
#GET 7, 6, 300, 89, 5, 5
Draw a grey arc
#GEA 4, 2, 200, 200, 0, 150, 150 -65, 65
#GEA 5, 2, 400, 200, 0, 150, 150, 115, -115
Change text size
#CTS 1, 28
Place strings
#SSP 8, 1, 180, 200, 6, "start"
#SSP 9, 1, 310, 311, 4, "r ccw"
#SSP 10, 1, 310, 89, 4, "r cw"
#SSP 11, 1, 410, 200, 4, "x|y"

```

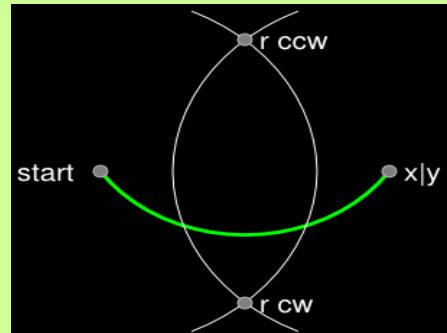

Ellipse polypath

```

Define green line style
#CLS 5, $00FF00, 100, 3
Refrain from defining a filling
#CFD 5
Define grey line style
#CLS 6, $BFBFBF, 100, 1
Define a grey filling
#CFC 6, $7F7F7F, 100
Set integer register
#VRI 0, 110, 150
Polypath ellipse green and grey
#GPP 1, 5, 200, 300, ?E1, R0, R1, 0, 400, 300
#GPP 4, 2, 200, 300, ?E2, R0, R1, 0, 400, 300
Set dots/circles
#GET 2, 6, 200, 300, 5, 5
#GET 3, 6, 400, 300, 5, 5
Change text size
#CTS 1, 28
Set strings
#SSP 8, 1, 180, 300, 6, "start"
#SSP 11, 1, 410, 300, 4, "x|y"

```

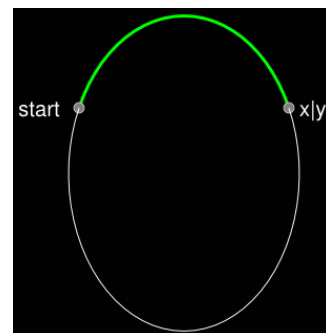

Segmente Q(uadratische Bézier Kurve), R

Polypfad quadratische Bézierkurve

Grünen Linienstyle definieren
#CLS 5, \$00FF00,100, 3
Keine Umrandung definieren
#CFD 5
Grauen Linienstyle definieren
#CLS 6, \$BFBFBF,100, 1
Graue Füllung definieren
#CFC 6, \$7F7F7F,100
Integer Register setzen
#VRI 0,250,200
Quadratische Bezierkurve zeichnen
#GPP 1, 5, 200,300,?QR0,R1,400,300
Punkte/Kreise setzen
#GET 2, 6, 200,300,5, 5
#GET 3, 6, 400,300,5, 5
#GET 4, 6, R0,R1,5, 5
Geraden zeichnen
#GPL 5, 2, 200,300, R0,R1
#GPL 6, 2, 400,300, R0,R1
Textgröße ändern
#CTS 1, 28
Strings setzen
#SSP 8, 1, 180,300,6, "start"
#SSP 11, 1, 410,300,4, "x|y"

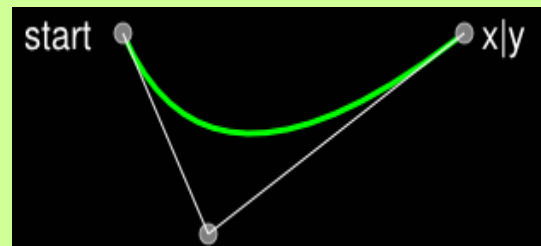

Segmente Q(uadratische Bézier Kurve), R

Polypfad quadratische Bézierkurve mit Hilfspunkt

```

Grünen Linienstyle definieren
#CLS 5, $00FF00,100, 3
Keine Füllung definieren
#CFD 5
Grauen Linienstyle definieren
#CLS 6, $BFBFBF,100, 1
Graue Füllung definieren
#CFC 6, $7F7F7F,100
Integer Register setzen
#VRI 0,210,200,300,300,460
Grünen Polypfad zeichnen
#GPP 1, 5, 200,R3,?QR0,R1,R2,R3, ?RR4,R3
Grauen Polypfad zeichnen
#GPL 2, 2,200,R3, R0,R1, R2,R3, (2*R2-R0),(2*R3-R1), R4,R3
Punkte/Kreise erzeugen
#GET 3, 6, 200,300,5, 5
#GET 4, 6, R0,R1,5, 5
#GET 6, 6, R2,R3,5, 5
#GET 7, 6, R2,R3,5, 5
#GET 8, 6, R4,300,5, 5
#GET 9, 6, (2*R2-R0),(2*R3-R1),5, 5
Schwarze Füllung mit 50% Deckkraft definieren
#CFC 4, $000000, 50
Rechteck erzeugen zum Abdunkeln
#GRR 5, 4, 195,(R1-5),7, (R2-R1+10), (R3-R1+10)
Textgröße ändern
#CTS 1, 28
Strings platzieren
#SSP 10, 1, (R2-10),(R3+5),6, "start"
#SSP 11, 1, (2*R2-R0-10),(2*R3-R1),6, "reflection point"
#SSP 12, 1, (R4+10),R3,4, "x|y"

```

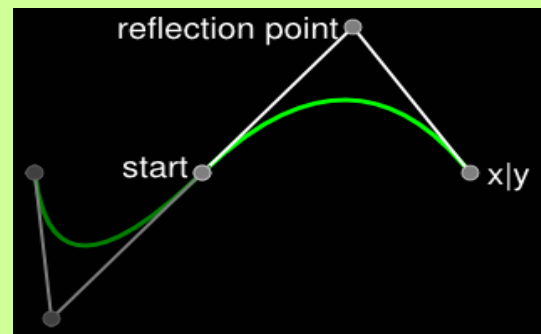

Segmente T, S(pline)

Polypfad Spline

```

Grünen Linienstyle definieren
#CLS 5, $00FF00,100, 3
Keine Füllung definieren
#CFD 5
Grauen Linienstyle definieren
#CLS 6, $BFBFBF,100, 1
Graue Füllung definieren
#CFC 6, $7F7F7F,100
Spline zeichnen
#GPP 1, 5, 100,50,?S150,100,250,100,300,50
Geraden Zeichnen
#GPL 2, 6, 100,50,150,100
#GPL 3, 6, 300,50,250,100
Punkte/Kreise erzeugen
#GET 4, 6, 150,100,5, 5
#GET 5, 6, 250,100,5, 5
#GET 6, 6, 100, 50,5, 5
#GET 7, 6, 300, 50,5, 5
Textgröße ändern
#CTS 1, 28
Strings platzieren
#SSP 8, 1, 90, 50,6, "start"
#SSP 9, 1, 150,110,8, "c1x|c1y"
#SSP 10, 1, 250,110,8, "c2x|c2y"
#SSP 11, 1, 310, 50,4, "x|y"

```

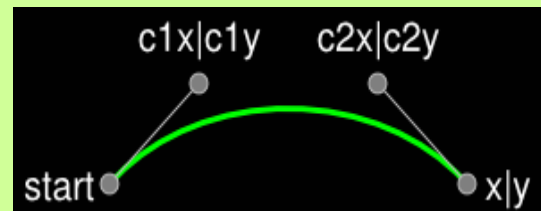

Segmente T, S(pline)

Polypfad geglättete kubische Bézierkurve

```

Grünen Linienstyle definieren
#CLS 5, $00FF00,100, 3
Keine Füllung definieren
#CFD 5
Grauen Linienstyle definieren
#CLS 6, $BFBFBF,100, 1
Graue Füllung definieren
#CFC 6, $7F7F7F,100
Integer Register setzen
#VRI 0, 200,200, -10,80, 60,40, 80,0, 70,-35, 100,0
Grünen Polypfad erzeugen
#GPP 1, 5, R0,R1,?sR2,R3,R4,R5,R6,R7, ?tR8,R9,R10,R11
Polypfad aus Geraden erzeugen
#GPL 9, 2, R0,R1, (R0+R2),(R1+R3), (R0+R4),(R1+R5), (R0+R6),
(R1+R7), (R0+2*R6-R4),(R1-R5), (R0+R6+R8),(R1+R7+R9),
(R0+R6+R10),(R1+R7+R11)
Punkte/Kreise erzeugen
#GET 2, 6, R0,R1,5, 5
#GET 3, 6, (R0+R2),(R1+R3),5, 5
#GET 4, 6, (R0+R4),(R1+R5),5, 5
#GET 5, 6, (R0+R6),(R1+R7),5, 5
#GET 6, 6, (R0+2*R6-R4),(R1-R5),5, 5
#GET 7, 6, (R0+R6+R8),(R1+R7+R9),5, 5
#GET 8, 6, (R0+R6+R10),(R1+R7+R11),5, 5
Schwarze Füllung mit 50% Deckkraft definieren
#CFC 4, $000000, 50
Rechteck erzeugen zum Abdunkeln
#GRR 20, 4, (R0-5+R2),(R1-5),7, (R6-R2+10),(R1+R3+5)
Textgröße ändern
#CTS 1, 28
Strings platzieren
#SSP 10, 1, (R0+R6+10),(R1+R7),4, "start"
#SSP 11, 1, (R0+2*R6-R4),(R1-R5-5),2, "reflection point"
#SSP 12, 1, (R0+R6+R8+10),(R1+R7+R9),4, "c2x|c2y"
#SSP 13, 1, (R0+R6+R10+10),(R1+R7+R11),4, "x|y"

```

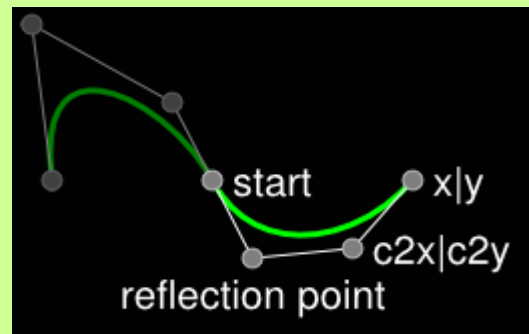

Segmente Z, M

Polyfad schließen

```

Grünen Linienstyle definieren
#CLS 5, $00FF00, 100, 3
Keine Füllung definieren
#CFD 5
Grauen Linienstyle definieren
#CLS 6, $BFBFBF, 100, 1
Graue Füllung definieren
#CFC 6, $7F7F7F, 100
Integer Register setzen
#VRI 0, 200, 200, 100, 70, 200, 0
Polyfad mit Pfadstop definieren
#GPP 1, 5, R0, R1, ?e1, R2, R3, 0, R4, R5, ?Z
Punkte/Kreise zeichnen
#GET 2, 6, R0, R1, 5, 5
#GET 3, 6, (R0+R4), (R0+R5), 5, 5
Textgröße ändern
#CTS 1, 28
Strings platzieren
#SSP 10, 1, (R0-10), (R1), 6, "start"
#SSP 11, 1, (R0+R4+10), (R0+R5), 4, "end"
#SSP 12, 1, (R0+R4/2), (R1-5), 2, "close path"
  
```

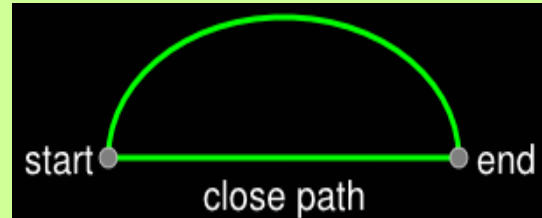

Polyfad Sprung

```

Grünen Linienstyle definieren
#CLS 5, $00FF00, 100, 3
Rote Füllung definieren
#CFD 5, $FF0000, 100
Grauen Linienstyle definieren
#CLS 6, $BFBFBF, 100, 1
Graue Füllung definieren
#CFC 6, $7F7F7F, 100
Integer Register setzen
#VRI 0, 200, 200, 100, 100, 10
Quadrat mit Kreis in der Mitte zeichnen
#GPP 1, 5, R0, R1, ?hR2, ?vR3, ?h(-R2), ?Z, ?M((R0+R2/2), (R1+R4), ?c1,
((R3-2*R4)/2), 0, (R3-2*R4), ?c1, ((R3-2*R4)/2), 0, (2*R4-R3)
Punkte/Kreise setzen
#GET 2, 6, R0, R1, 5, 5
#GET 3, 6, (R0+R2/2), (R1+R4), 5, 5
Textgröße ändern
#CTS 1, 28
Strings setzen
#SSP 4, 1, (R0-10), (R1), 6, "start"
#SSP 5, 1, (R0+R2/2), (R1+R4+5), 8, "Move"
  
```

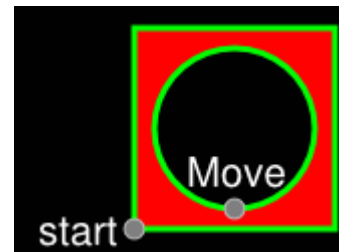

ELECTRICAL SPECIFICATION

Value	Condition	min.	typ.	max.	Unit
Operating temperature		-20		+70	°C
Storage temperature		-30		+80	°C
Storage humidity				90% RH	@ 60°C
Operating voltage		3.1	3.3	3.5	V
Supply current	Backlight 100%		750		mA
	Backlight 0%		350		mA
Input low voltage (except USB, I/O)		-0.3	0	0.3*VDD	V
Input high voltage (except USB, I/O)		VDD*0.7		VDD+0.3	V
Output low voltage (except USB, I/O)		-	-	0.4	V
Output high voltage (except USB, I/O)		VDD-0.5	-	-	V
Input low voltage I/O		-	-	0.2*VDD	V
Input high voltage I/O		0.8*VDD	-	-	V
Output low voltage I/O		-	-	0.6*VDD	V
Output high voltage I/O		VDD-0.7	-	-	V
Output current I/O		-	-	25	mA
		-	-	125	mA (total)
I ² C-bus pull-up				1	MΩ
Brightness	w./o. Touchpanel		700		cd/m ²
	with Capactive Touchpanel				
	with Resistive Touchpanel				

DIMENSIONS

