

Features

- Epitaxial Planar Die Construction
- Ideally Suited for Automated Assembly Processes
- Ideal for Medium Power Switching or Amplification Applications
- **Lead Free By Design/RoHS Compliant (Note 1)**
- **"Green" Device (Note 2)**

Mechanical Data

- Case: SOT89
- Case Material: Molded Plastic, "Green" Molding Compound. UL Flammability Classification Rating 94V-0
- Moisture Sensitivity: Level 1 per J-STD-020
- Terminals: Finish — Matte Tin annealed over Copper leadframe (Lead Free Plating). Solderable per MIL-STD-202, Method 208
- Weight: 0.055 grams (approximate)

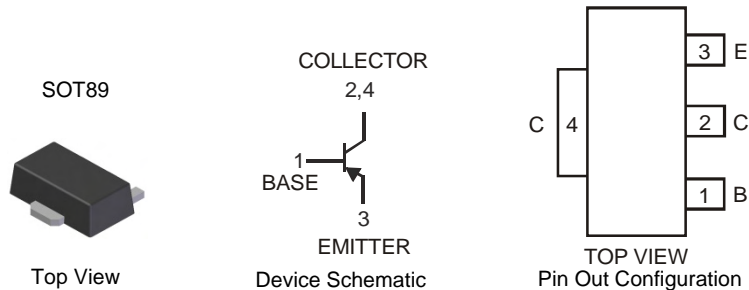

Ordering Information (Note 3)

Part Number	Case	Packaging
2DB1386Q-13	SOT89	2500/Tape & Reel
2DB1386R-13	SOT89	2500/Tape & Reel

- Notes:
1. No purposefully added lead.
 2. Diodes Inc.'s "Green" policy can be found on our website at <http://www.diodes.com>.
 3. For packaging details, go to our website at <http://www.diodes.com>.

Marking Information



KP3x = Product Type Marking Code,
 where: KP3Q = 2DB1386Q
 KP3R = 2DB1386R
 YWW = Date Code Marking
 Y = Last digit of year (ex: 7 = 2007)
 WW = Week code (01 – 53)

Maximum Ratings @ $T_A = 25^\circ\text{C}$ unless otherwise specified

Characteristic	Symbol	Value	Unit
Collector-Base Voltage	V_{CBO}	-30	V
Collector-Emitter Voltage	V_{CEO}	-20	V
Emitter-Base Voltage	V_{EBO}	-6	V
Peak Pulse Current	I_{CM}	-10	A
Continuous Collector Current	I_C	-5	A

Thermal Characteristics

Characteristic	Symbol	Value	Unit
Power Dissipation (Note 4) @ $T_A = 25^\circ\text{C}$	P_D	1	W
Thermal Resistance, Junction to Ambient Air (Note 4) @ $T_A = 25^\circ\text{C}$	$R_{\theta JA}$	125	$^\circ\text{C/W}$
Operating and Storage Temperature Range	T_J, T_{STG}	-55 to +150	$^\circ\text{C}$

Electrical Characteristics @ $T_A = 25^\circ\text{C}$ unless otherwise specified

Characteristic	Symbol	Min	Typ	Max	Unit	Conditions
OFF CHARACTERISTICS (Note 5)						
Collector-Base Breakdown Voltage	$V_{(BR)CBO}$	-30	—	—	V	$I_C = -50\mu\text{A}, I_E = 0$
Collector-Emitter Breakdown Voltage	$V_{(BR)CEO}$	-20	—	—	V	$I_C = -1\text{mA}, I_B = 0$
Emitter-Base Breakdown Voltage	$V_{(BR)EBO}$	-6	—	—	V	$I_E = -50\mu\text{A}, I_C = 0$
Collector Cut-Off Current	I_{CBO}	—	—	-0.5	μA	$V_{CB} = -20\text{V}, I_E = 0$
Emitter Cut-Off Current	I_{EBO}	—	—	-0.5	μA	$V_{EB} = -5\text{V}, I_C = 0$
ON CHARACTERISTICS (Note 5)						
Collector-Emitter Saturation Voltage	$V_{CE(SAT)}$	—	-0.25	-1.0	V	$I_C = -4\text{A}, I_B = -0.1\text{A}$
DC Current Gain	2DB1386Q	120	—	270	—	$I_C = -0.5\text{A}, V_{CE} = -2\text{V}$
	2DB1386R	180	—	390		
SMALL SIGNAL CHARACTERISTICS						
Output Capacitance	C_{obo}	—	55	—	pF	$V_{CB} = -20\text{V}, I_E = 0, f = 1\text{MHz}$
Current Gain-Bandwidth Product	f_T	—	100	—	MHz	$V_{CE} = -6\text{V}, I_E = 50\text{mA}, f = 30\text{MHz}$

- Notes: 4. Device mounted on FR-4 PCB; pad layout as shown on page 4 or in Diodes Inc. suggested pad layout document AP02001, which can be found on our website at <http://www.diodes.com>.
 5. Measured under pulsed conditions. Pulse width = 300 μs . Duty cycle $\leq 2\%$.

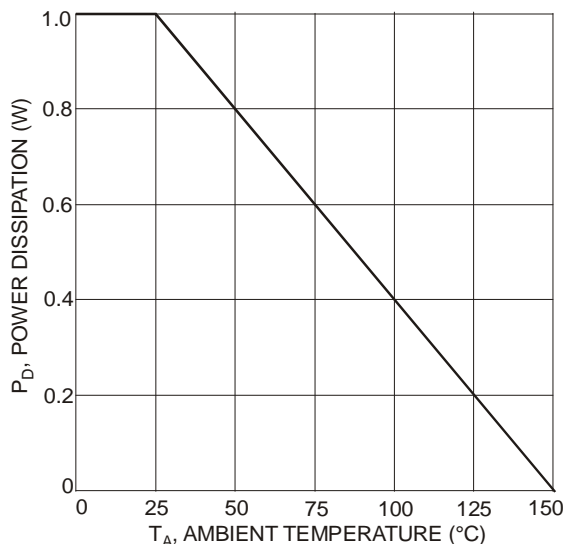

Fig. 1 Power Dissipation vs. Ambient Temperature (Note 4)

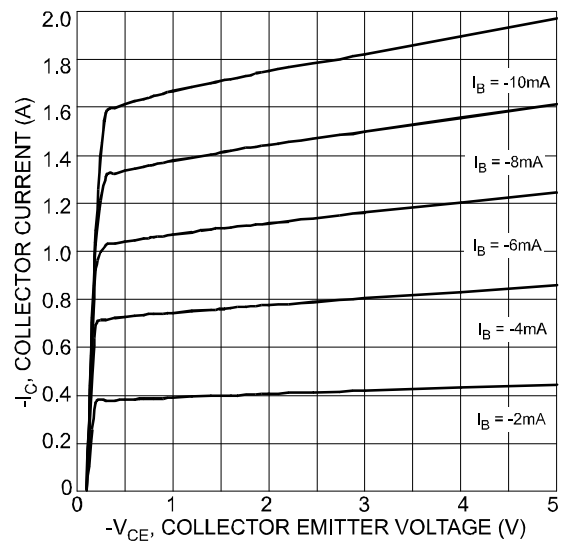

Fig. 2 Typical Collector Current vs. Collector-Emitter Voltage

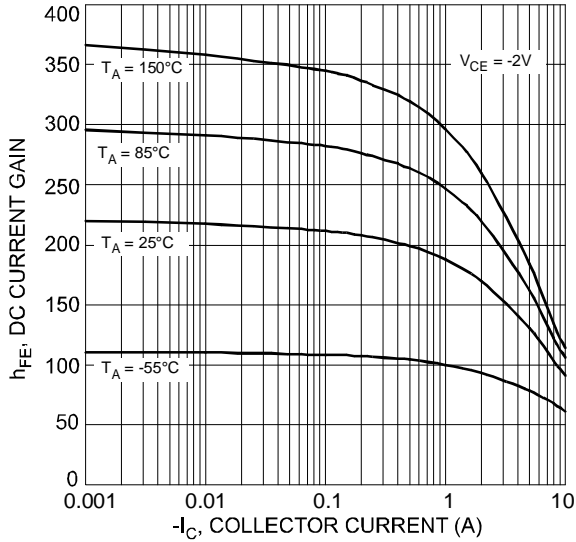

Fig. 3 Typical DC Current Gain vs. Collector Current (2DB1386Q)

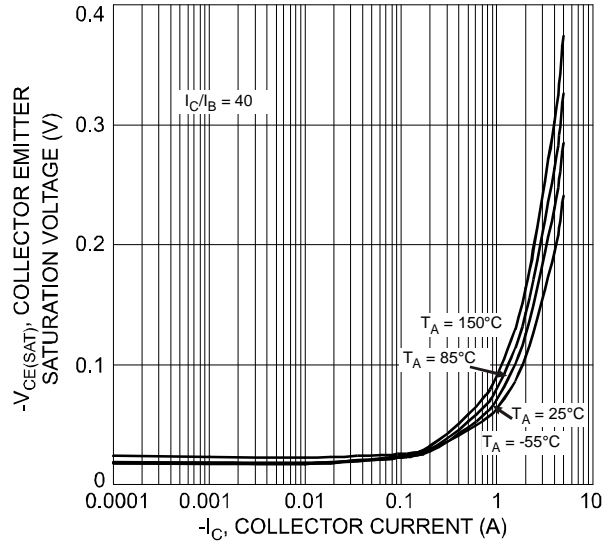

Fig. 4 Typical Collector-Emitter Saturation Voltage vs. Collector Current

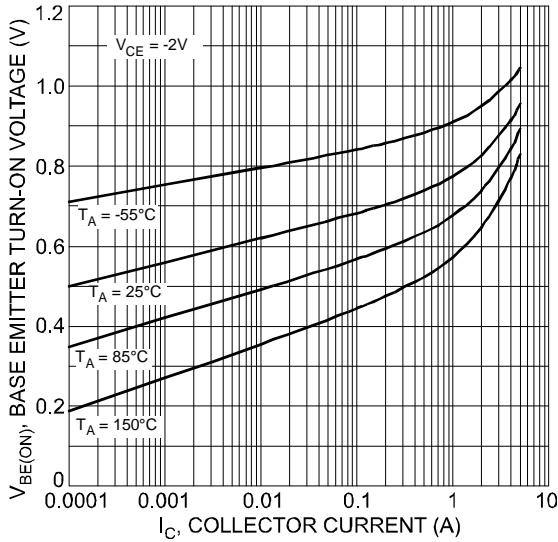

Fig. 5 Typical Base-Emitter Turn-On Voltage vs. Collector Current

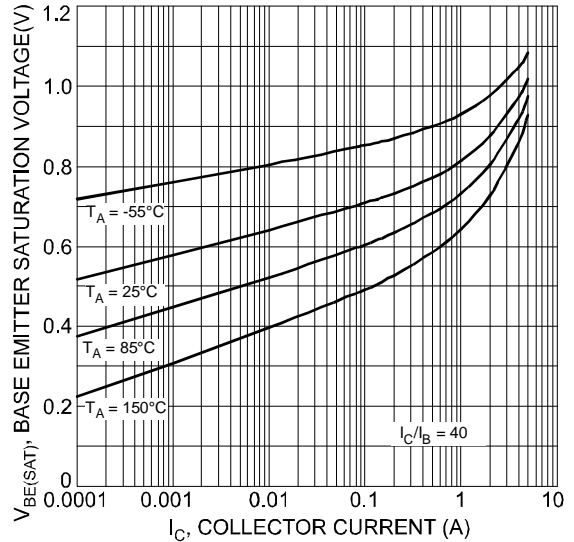

Fig. 6 Typical Base-Emitter Saturation Voltage vs. Collector Current

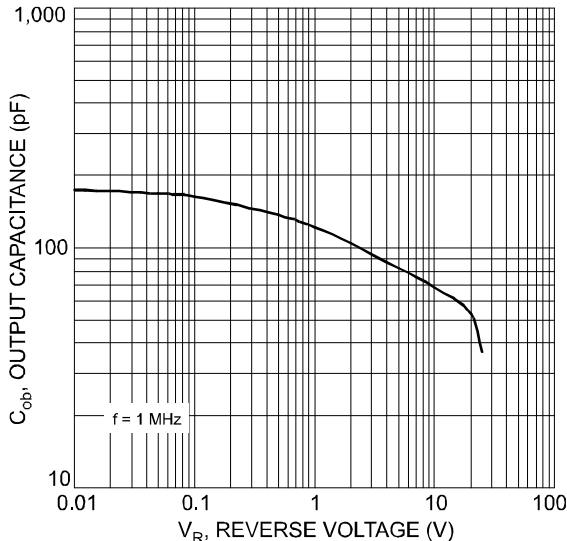

Fig. 7 Typical Output Capacitance Characteristics

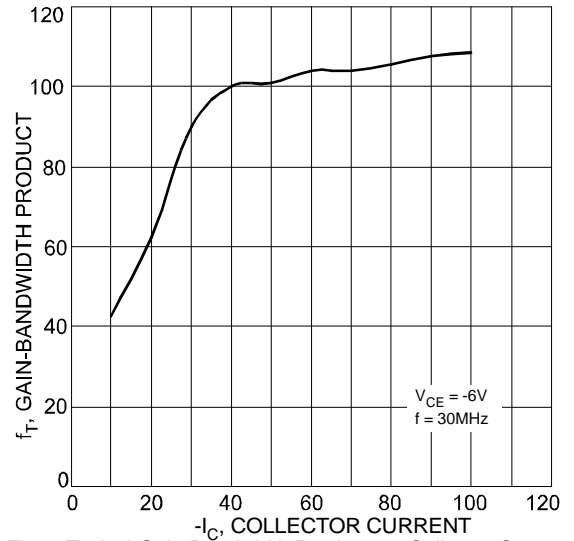
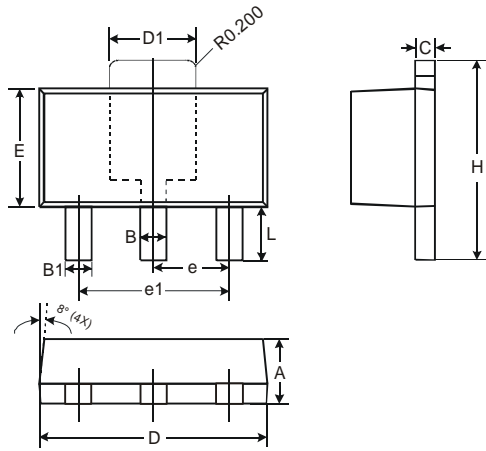

Fig. 8 Typical Gain-Bandwidth Product vs. Collector Current

Package Outline Dimensions



SOT89		
Dim	Min	Max
A	1.40	1.60
B	0.44	0.62
B1	0.35	0.54
C	0.35	0.43
D	4.40	4.60
D1	1.52	1.83
E	2.29	2.60
e	1.50 Typ	
e1	3.00 Typ	
H	3.94	4.25
L	0.89	1.20
All Dimensions in mm		

Suggested Pad Layout

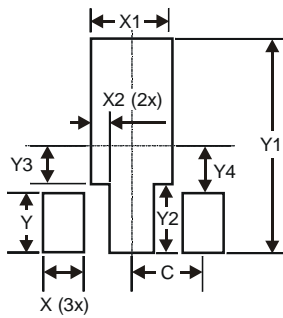

Dimensions	Value (in mm)
X	0.900
X1	1.733
X2	0.416
Y	1.300
Y1	4.600
Y2	1.475
Y3	0.950
Y4	1.125
C	1.500

IMPORTANT NOTICE

DIODES INCORPORATED MAKES NO WARRANTY OF ANY KIND, EXPRESS OR IMPLIED, WITH REGARDS TO THIS DOCUMENT, INCLUDING, BUT NOT LIMITED TO, THE IMPLIED WARRANTIES OF MERCHANTABILITY AND FITNESS FOR A PARTICULAR PURPOSE (AND THEIR EQUIVALENTS UNDER THE LAWS OF ANY JURISDICTION).

Diodes Incorporated and its subsidiaries reserve the right to make modifications, enhancements, improvements, corrections or other changes without further notice to this document and any product described herein. Diodes Incorporated does not assume any liability arising out of the application or use of this document or any product described herein; neither does Diodes Incorporated convey any license under its patent or trademark rights, nor the rights of others. Any Customer or user of this document or products described herein in such applications shall assume all risks of such use and will agree to hold Diodes Incorporated and all the companies whose products are represented on Diodes Incorporated website, harmless against all damages.

Diodes Incorporated does not warrant or accept any liability whatsoever in respect of any products purchased through unauthorized sales channel. Should Customers purchase or use Diodes Incorporated products for any unintended or unauthorized application, Customers shall indemnify and hold Diodes Incorporated and its representatives harmless against all claims, damages, expenses, and attorney fees arising out of, directly or indirectly, any claim of personal injury or death associated with such unintended or unauthorized application.

Products described herein may be covered by one or more United States, international or foreign patents pending. Product names and markings noted herein may also be covered by one or more United States, international or foreign trademarks.

LIFE SUPPORT

Diodes Incorporated products are specifically not authorized for use as critical components in life support devices or systems without the express written approval of the Chief Executive Officer of Diodes Incorporated. As used herein:

A. Life support devices or systems are devices or systems which:

1. are intended to implant into the body, or
2. support or sustain life and whose failure to perform when properly used in accordance with instructions for use provided in the labeling can be reasonably expected to result in significant injury to the user.

B. A critical component is any component in a life support device or system whose failure to perform can be reasonably expected to cause the failure of the life support device or to affect its safety or effectiveness.

Customers represent that they have all necessary expertise in the safety and regulatory ramifications of their life support devices or systems, and acknowledge and agree that they are solely responsible for all legal, regulatory and safety-related requirements concerning their products and any use of Diodes Incorporated products in such safety-critical, life support devices or systems, notwithstanding any devices- or systems-related information or support that may be provided by Diodes Incorporated. Further, Customers must fully indemnify Diodes Incorporated and its representatives against any damages arising out of the use of Diodes Incorporated products in such safety-critical, life support devices or systems.

Copyright © 2011, Diodes Incorporated

www.diodes.com