



Released

GRF5020

30.5 dBm Power-LNA™
Tuning Range: 0.1 – 6.0 GHz



Product Description

GRF5020 is a high linearity PA with ultra-low noise figure (NF). The primary tune for this device covers 1.7 to 2.7 GHz and it achieves outstanding P1dB, IP3 and NF over the band. The device can be tuned to deliver outstanding performance over 0.1 GHz. to 6.0 GHz with fractional bandwidths >30%. With a 10.0 Volt supply, the device can deliver broadband OP1dB values >30.0 dBm.

In addition to use as a PA or linear driver, GRF5020 is well suited to demanding first, second or third stage LNA applications requiring high linearity, ruggedness and low NF.

Consult with the GRF applications engineering team for custom tuning/evaluation board data and device s-parameters.

Features

Reference: 8.0V/95mA/2.5GHz

- Gain: 18.0 dB
- NF: 0.85 dB
- OP1dB: 29.0 dBm
- OIP3: 43.0 dBm

Reference: 5.0V/65mA/2.5GHz

- Gain: 17.3 dB
- NF: 0.80 dB
- OP1dB: 24.5 dBm
- OIP3: 37.2 dBm
- Flexible Bias Voltage and Current
- Process: GaAs pHEMT

Applications

- Multi-stage LNA
- Linear Driver Amplifier for High PAR Waveforms
- Distributed Antenna Systems
- Microwave Backhaul

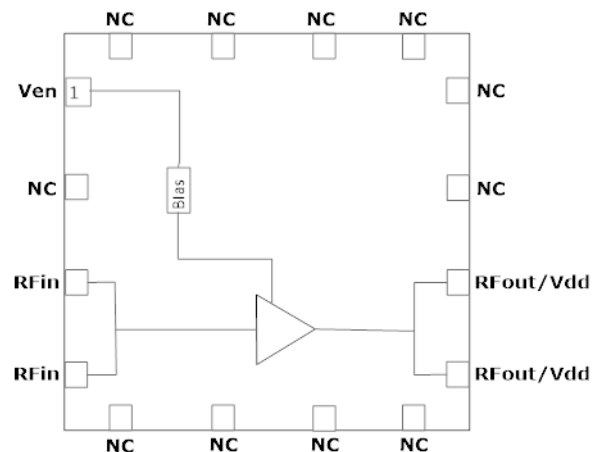

3.0 x 3.0 mm QFN-16



Released

GRF5020

30.5 dBm Power-LNA™
Tuning Range: 0.1 – 6.0 GHz

Absolute Ratings:

Parameter	Symbol	Min.	Max.	Unit
Drain Voltage	V _{DD}		12.0	V
Transient Average RF Input Power CW: (Load VSWR < 2:1; Duration: <1 hour)	P _{IN MAX}		22.0	dBm
Average RF Output Power: (Load VSWR < 2:1; V _D > 8.0 volts; Duration: Continuous)	P _{OUT MAX}		26.0	dBm
Average RF Output Power: (Load VSWR < 2:1; V _D ≤ 8.0 volts; Duration: Continuous)	P _{OUT MAX}		NA	dBm
Operating Temperature (Package Heat Sink)	T _{AMB}	-40	105	°C
Maximum Channel Temperature (MTTF > 10 ⁶ Hours)	T _{MAX}		170	°C
Maximum Dissipated Power	P _{DISS MAX}		1.9	W
Electrostatic Discharge:				
Charged Device Model: (TBD)	CDM	1500		V
Human Body Model:	HBM	250		V
Storage:				
Storage Temperature	T _{STG}	-65	150	°C
Moisture Sensitivity Level	MSL		1	–



Caution! ESD Sensitive Device



Exceeding Absolute Maximum Rating conditions may cause permanent damage to the device.

Note: For package dimensions and manufacturing information, see the Guerrilla-RF.com website for the following document located on the GRF5020 landing page: Manufacturing Note—MN-001 Product Tape and Reel, Solderability and Package Outline Specification.

[Link to manufacturing note](#)

Pin Out (Top View)

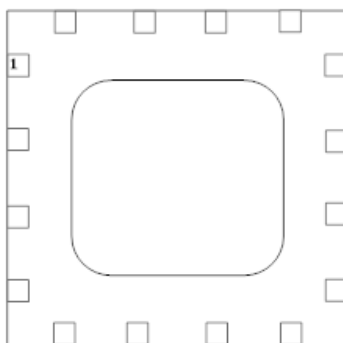

Pin Assignments:

Pin	Name	Description	Note
1	V _{ENABLE}	Enable Voltage Input	V _{ENABLE} and series resistor set I _{DDQ} . V _{ENABLE} < =0.2 volts disables device. On-die pull-down resistor will turn the part off if this node is allowed to float.
2	NC	No Connect or Ground	No internal connection to die
3	RF_In	RF Input	Pins 3-4 tied together on system board
4	RF_In	RF Input	Pins 3-4 tied together on system board
5	NC	No Connect or Ground	No internal connection to die
6	NC	No Connect or Ground	No internal connection to die
7	NC	No Connect or Ground	No internal connection to die
8	NC	No Connect or Ground	No internal connection to die
9	RF_Out/V _{DD}	PA Output/Bias	Pins 9-10 tied together on system board. Supply V _{dd} here.
10	RF_Out/V _{DD}	PA Output/Bias	Pins 9-10 tied together on system board. Supply V _{dd} here.
11	NC	No Connect or Ground	No internal connection to die
12	NC	No Connect or Ground	No internal connection to die
13	NC	No Connect or Ground	No internal connection to die
14	NC	No Connect or Ground	No internal connection to die
15	NC	No Connect or Ground	No internal connection to die
16	NC	No Connect or Ground	No internal connection to die
PKG BASE	GND	Ground	Provides DC and RF ground for LNA, as well as thermal heat sink. Recommend multiple 8 mil vias beneath the package for optimal RF and thermal performance. Refer to evaluation board top layer graphic on schematic page.



Released

GRF5020

30.5 dBm Power-LNA™
Tuning Range: 0.1 – 6.0 GHz

Nominal Operating Parameters:

Parameter	Symbol	Specification			Unit	Condition
		Min.	Typ.	Max.		
Target Performance (1.7-3.8 GHz Tune)						Bias: 8.0 V and 95 mA unless otherwise noted. (+25C)
Test Frequency	F _{TEST}		2.5		GHz	
Gain	S(2,1)	16.0	17.5		dB	
Noise Figure (Evaluation Board)	NF		0.85	1.05	dB	
Output 1dB Compression Point	OP1dB	27.5	29.0		dBm	
Output Third Order Intercept Point	OIP3		43.0		dBm	Tones: 2499 and 2501 MHz at 8.0 dBm per tone
Switching Rise Time	T _{RISE}		200		ns	
Switching Fall Time	T _{FALL}		200		ns	
Quiescent Supply Current	I _{DDQ}		95		mA	
Enable Current	I _{ENABLE}		2.0		mA	
Disabled Mode						V _{DD} : 8.0 volts; V _{ENABLE} : 0.0 volts
Supply Current (Leakage)	I _{DD}		300	600	uA	
Thermal Data						
Thermal Resistance: (IR Scan Method)	Θ _{jc}		43		°C/W	
Channel Temperature @ +85C Reference (package heat sink)	T _{CHANNEL}		118		°C	V _{DD} : 8.0 volts; I _{DDQ} : 95 mA P _{DISS} : 0.76 W; No RF



Released

GRF5020

30.5 dBm Power-LNA™
Tuning Range: 0.1 – 6.0 GHz

GRF5020 Evaluation Board Data vs. Supply Voltage (1.7 to 2.7GHz Tune)

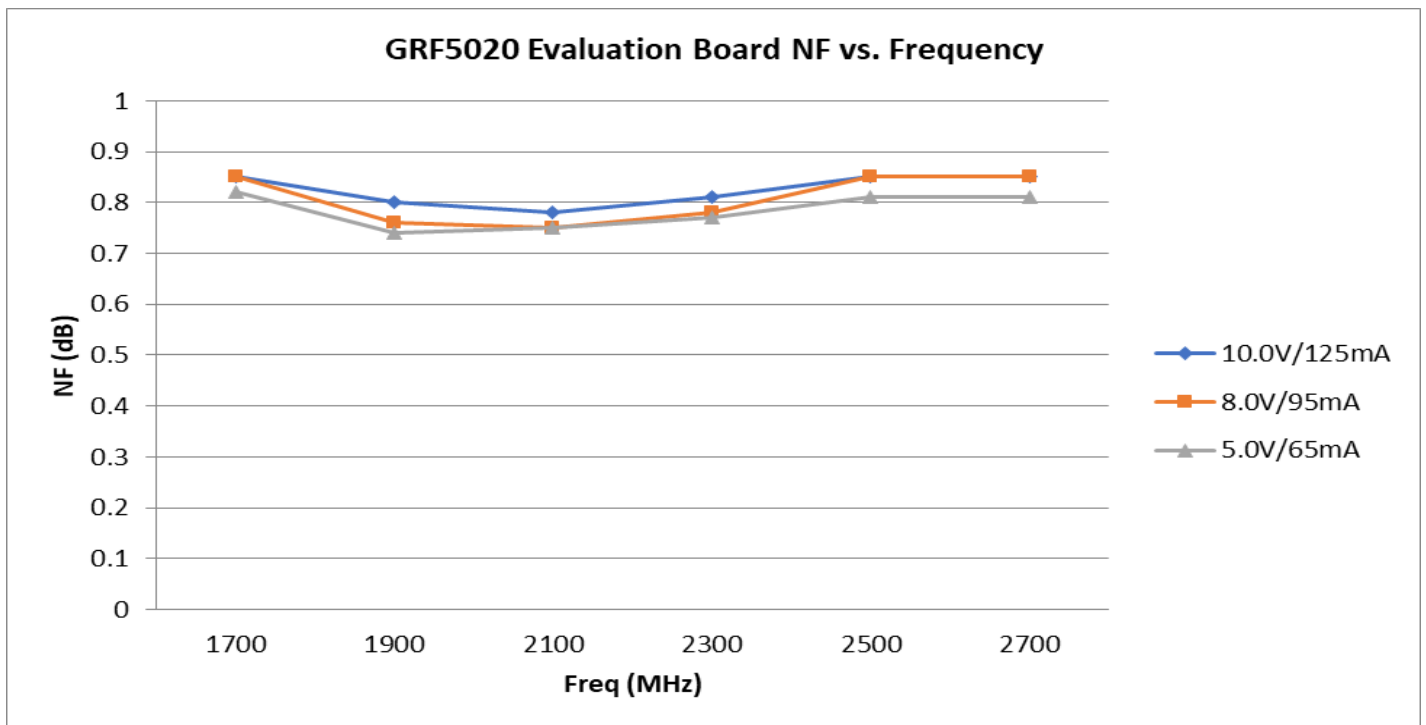
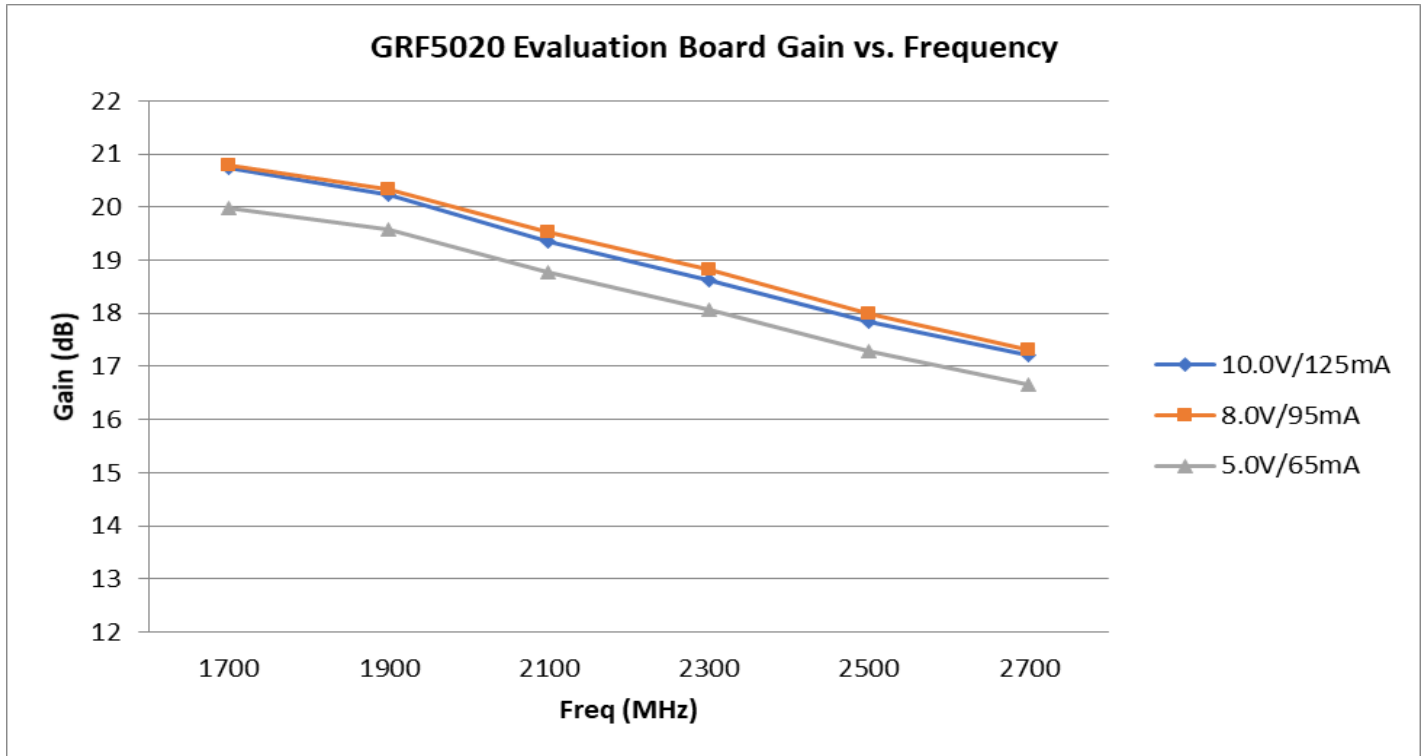



Released

GRF5020

30.5 dBm Power-LNA™
Tuning Range: 0.1 – 6.0 GHz

GRF5020 Evaluation Board Data vs. Supply Voltage (1.7 to 2.7GHz Tune)

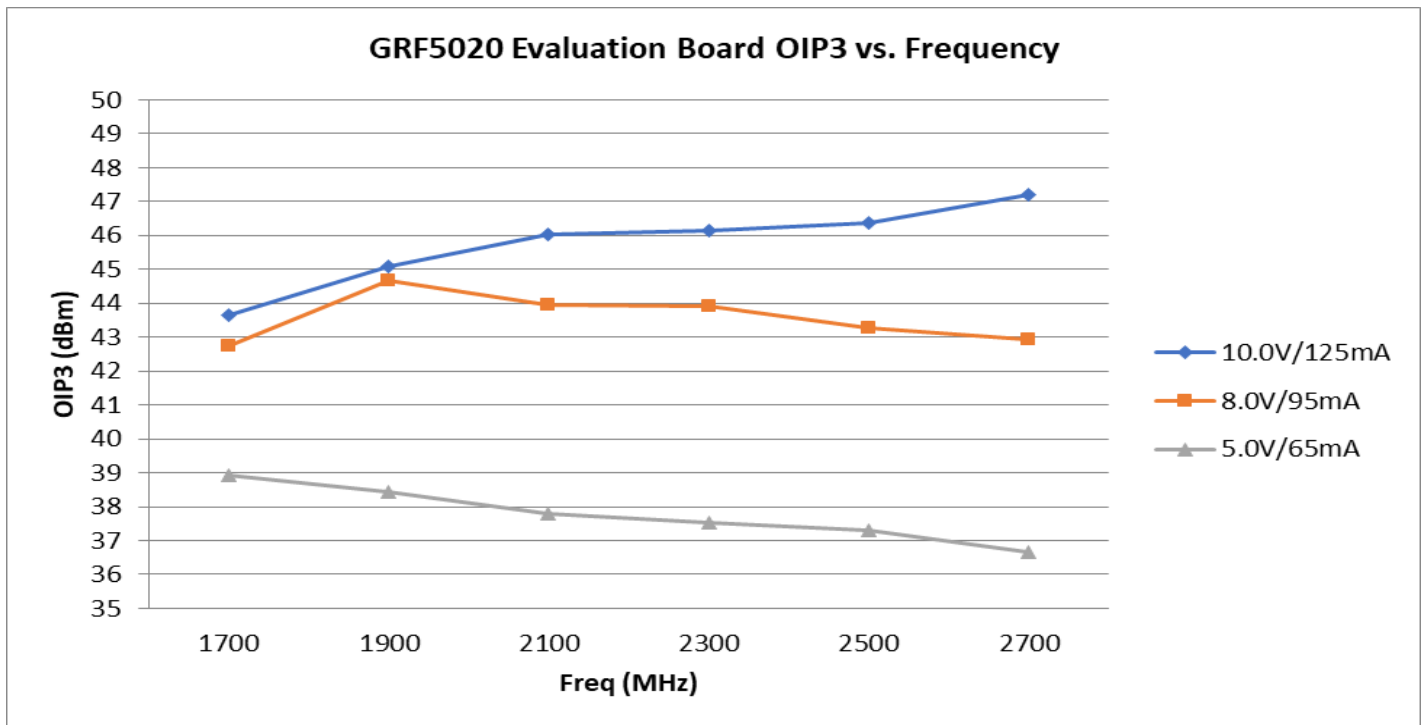
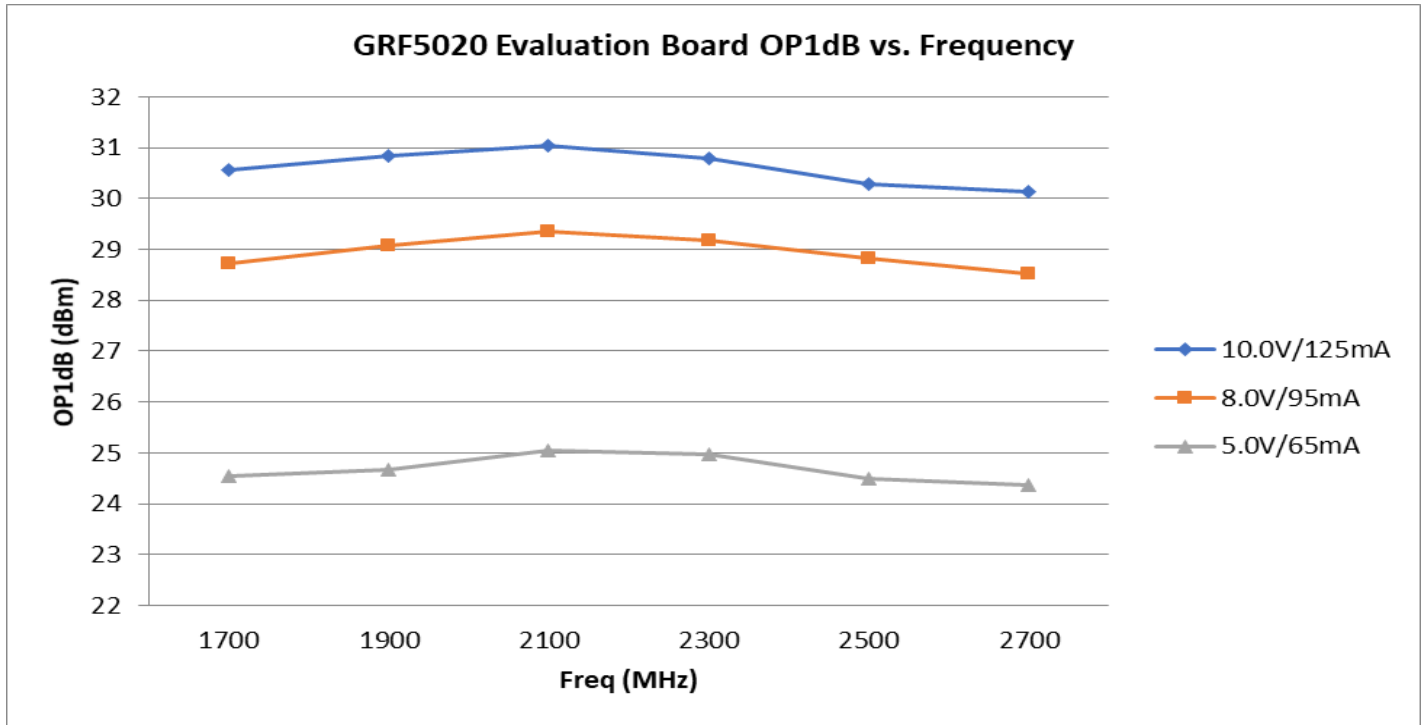



Released

GRF5020

30.5 dBm Power-LNA™
Tuning Range: 0.1 – 6.0 GHz

GRF5020 Evaluation Board Data vs. Temperature; Bias: 8.0 volts (1.7 to 2.7GHz Tune)

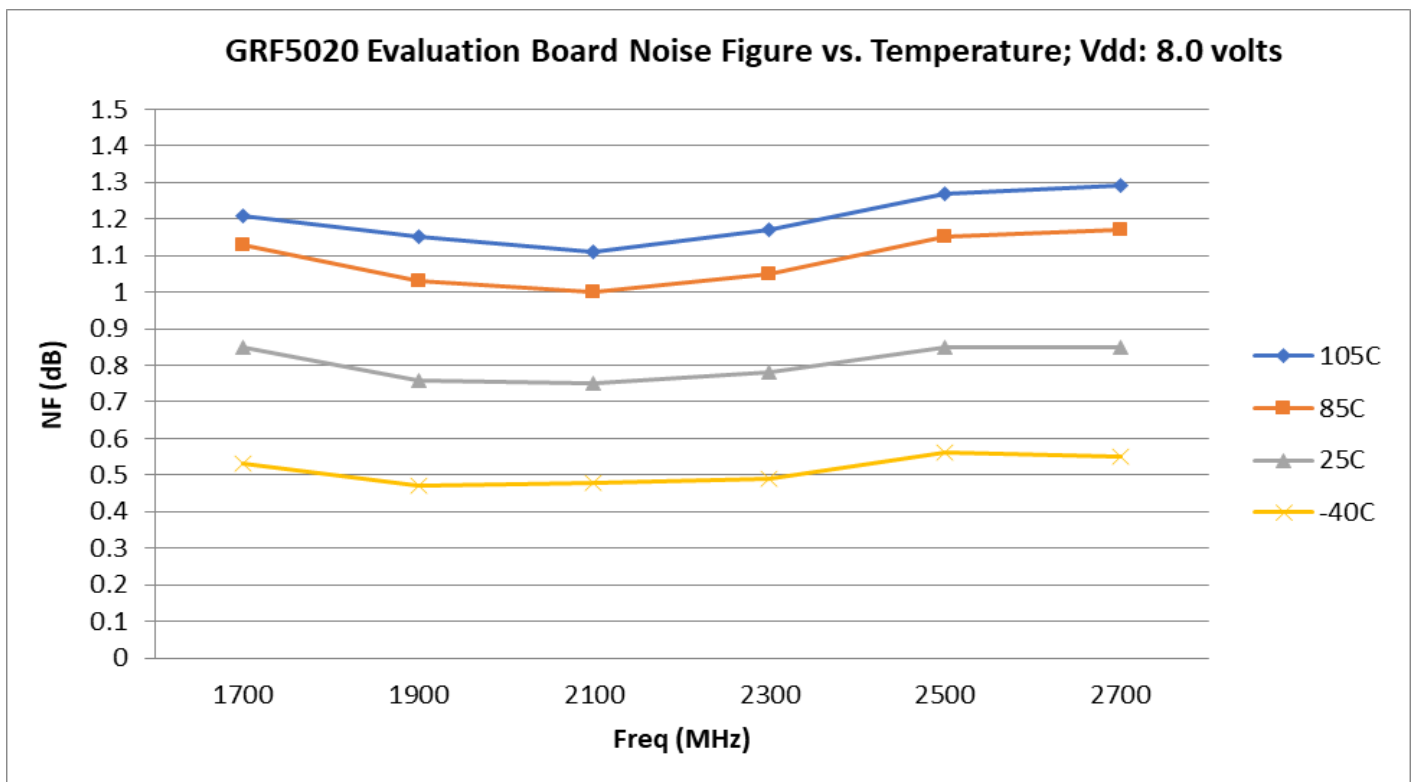
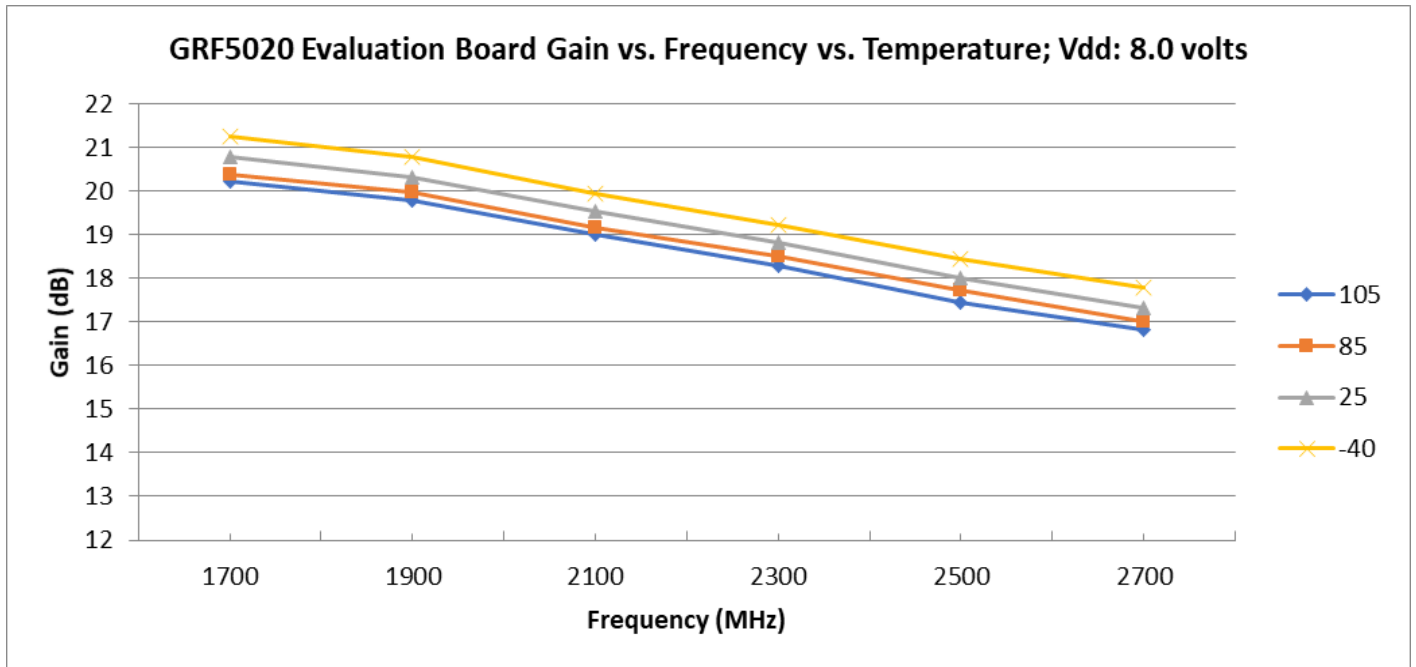



Released

GRF5020

30.5 dBm Power-LNA™
Tuning Range: 0.1 – 6.0 GHz

GRF5020 Evaluation Board Data vs. Temperature; Bias: 8.0 volts (1.7 to 2.7GHz Tune)

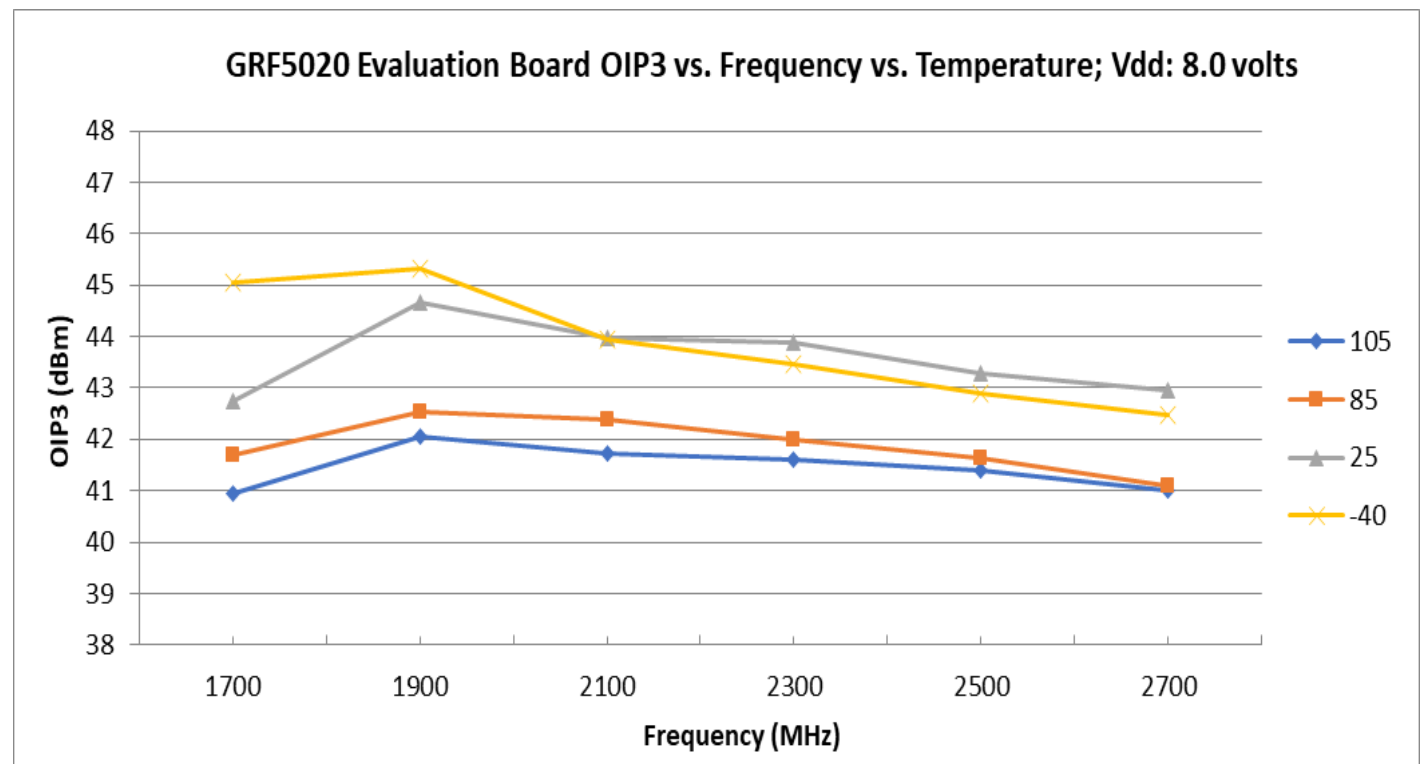
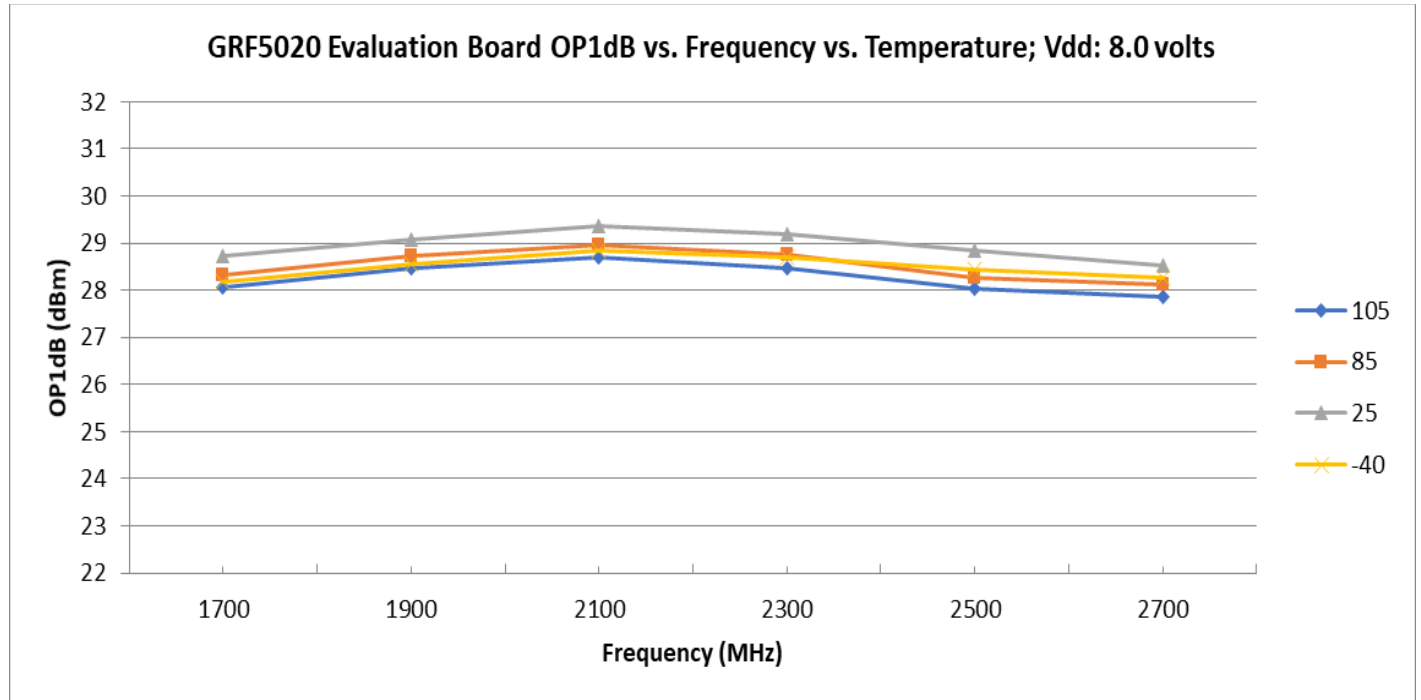



Released

GRF5020

30.5 dBm Power-LNA™
Tuning Range: 0.1 – 6.0 GHz

GRF5020 Evaluation Board Data vs. Temperature; (1.7 to 2.7GHz Tune)

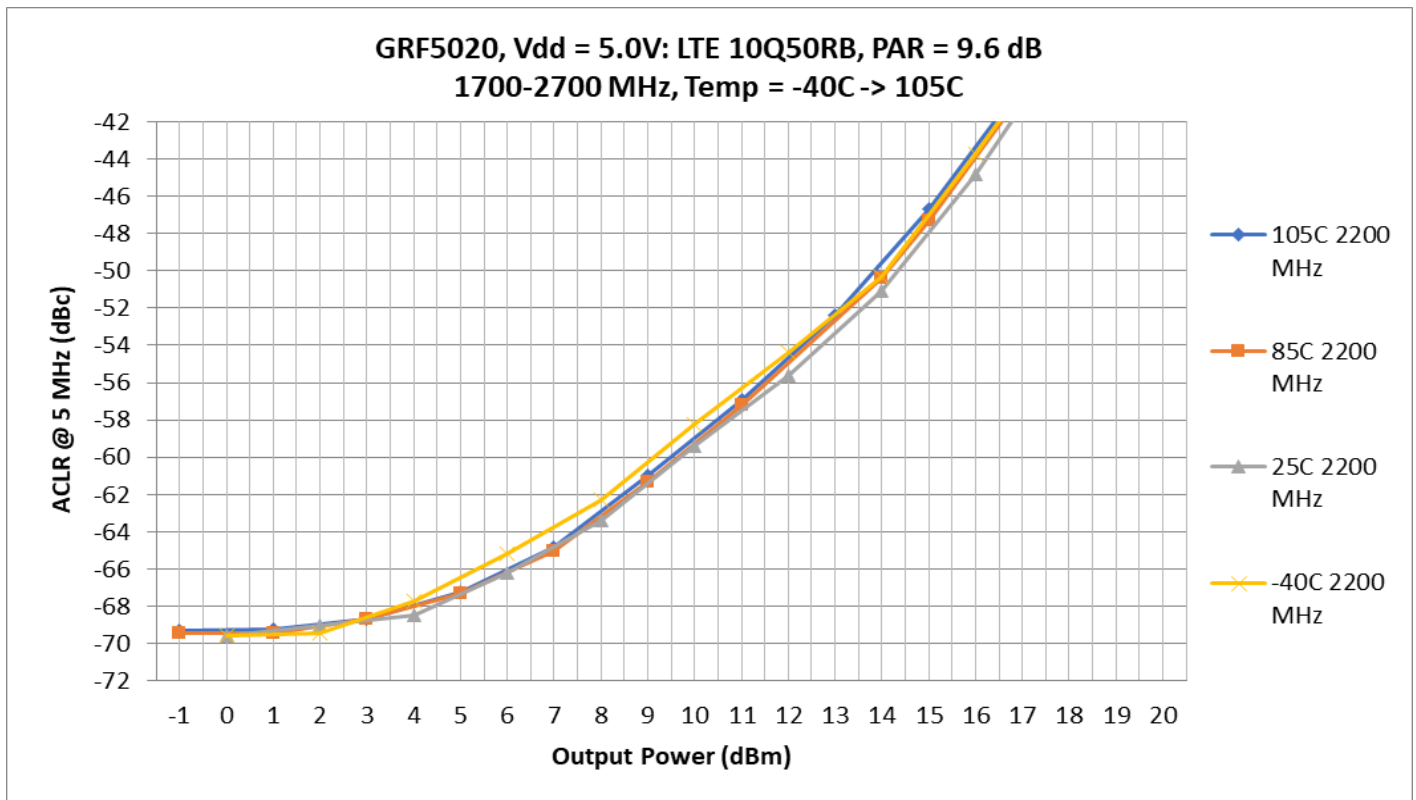
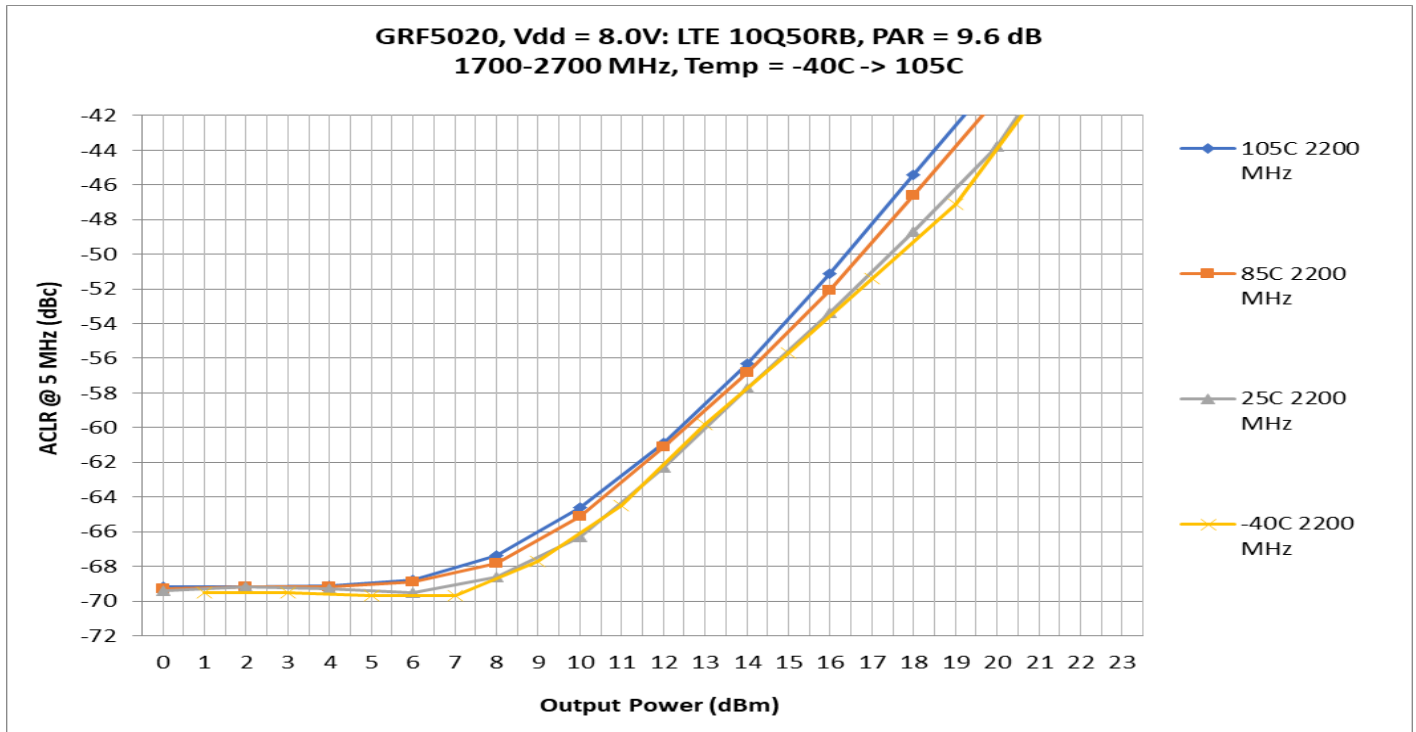

Guerrilla RF Proprietary Information. Guerrilla RF™ and the composite logo of Guerrilla RF™ are trademarks of Guerrilla RF, Inc. ©2014 Guerrilla RF, Inc. All rights reserved.



Released

GRF5020

30.5 dBm Power-LNA™
Tuning Range: 0.1 – 6.0 GHz

GRF5020 Evaluation Board S-Params; 5V/95 mA: (1.7 to 2.7 GHz Tune)

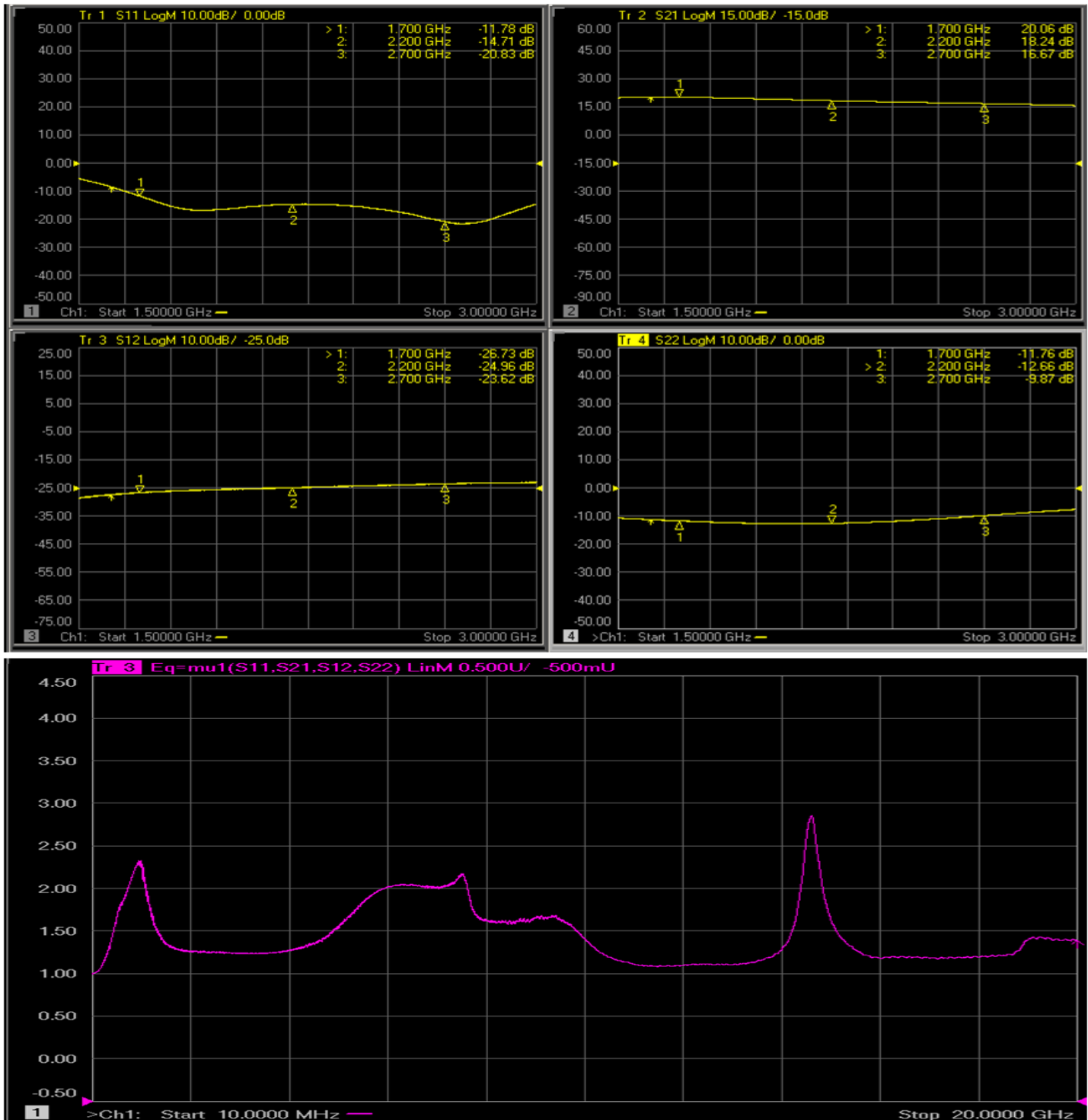

Note: Mu factor ≥ 1.0 implies unconditional stability.

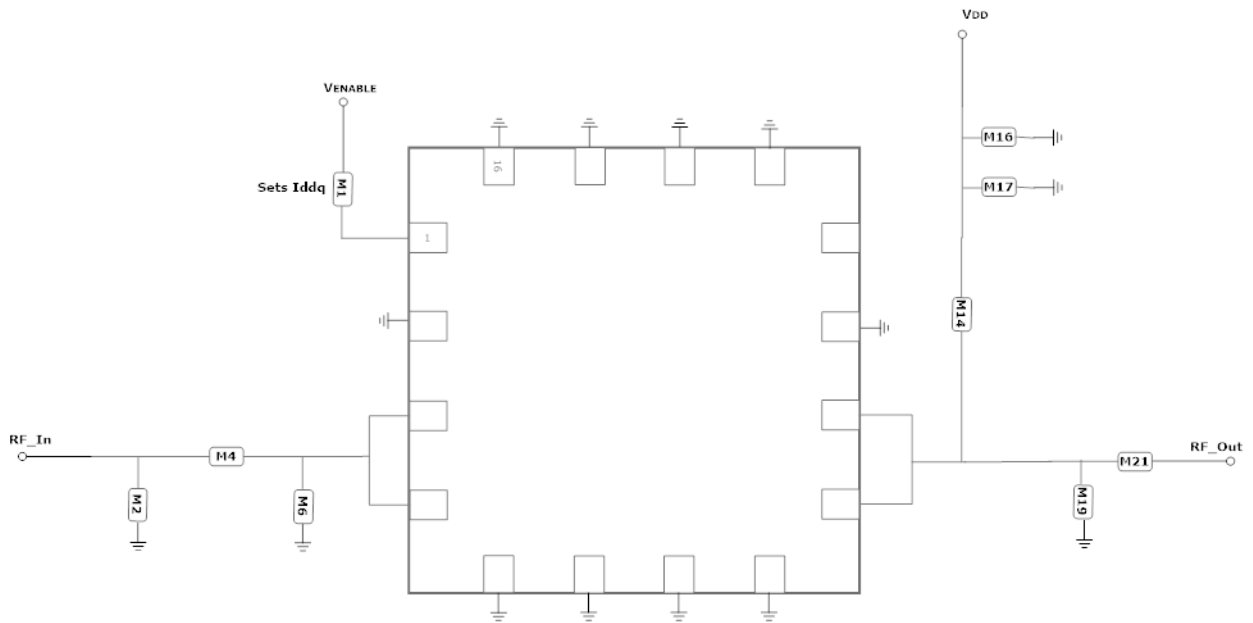

GRF5020 Application Schematic: (1.7 to 2.7 GHz)

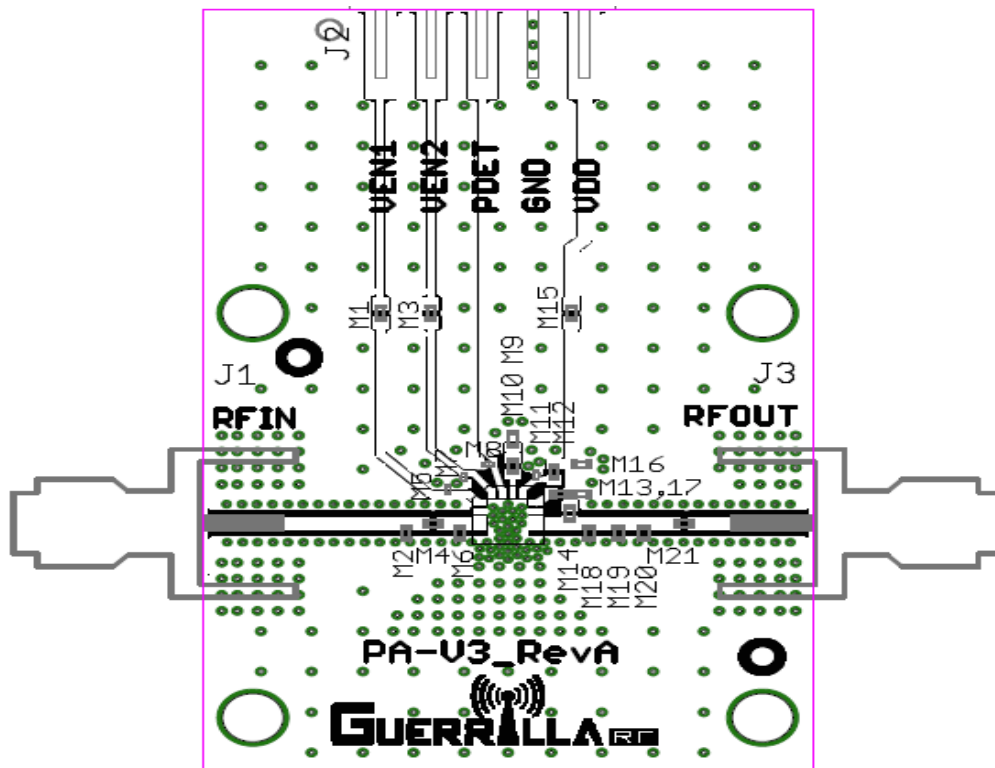

GRF50XX Evaluation Board Assembly Drawing



Released

GRF5020

30.5 dBm Power-LNA™
Tuning Range: 0.1 – 6.0 GHz

GRF5020 Evaluation Board BOM: (1.7–2.7GHz)

Component	Type	Manufacturer	Family	Value	Package Size	Substitution
M1 (See curves)	Resistor	Various	5%	Sets Iddq	0402	ok
M2	Inductor: High Q	Coilcraft	HP	3.3 nH	0402	ok
M4	Capacitor: High Q	Murata	GJM	2.0 pF	0402	ok
M6	Capacitor: High Q	Murata	GJM	1.8 pF	0402	ok
M13	Capacitor	Murata	GRM	100 pF	0402	ok
M14	Inductor: High Q	Coilcraft	HP	15 nH	0402	ok
M16	Capacitor	Murata	GRM	0.1 uF	0402	ok
M19	DNP	—	—	—	—	—
M21	Capacitor	Murata	GJM	18 pF	0402	ok
Evaluation Board	PA-V3_RevA					

Note: Standard evaluation board bias: Vdd: 8.0V; Venable: 5.0V; M1:



Released

GRF5020

30.5 dBm Power-LNA™
Tuning Range: 0.1 – 6.0 GHz

GRF5020 Bias Resistor (M1) Selection Curves:

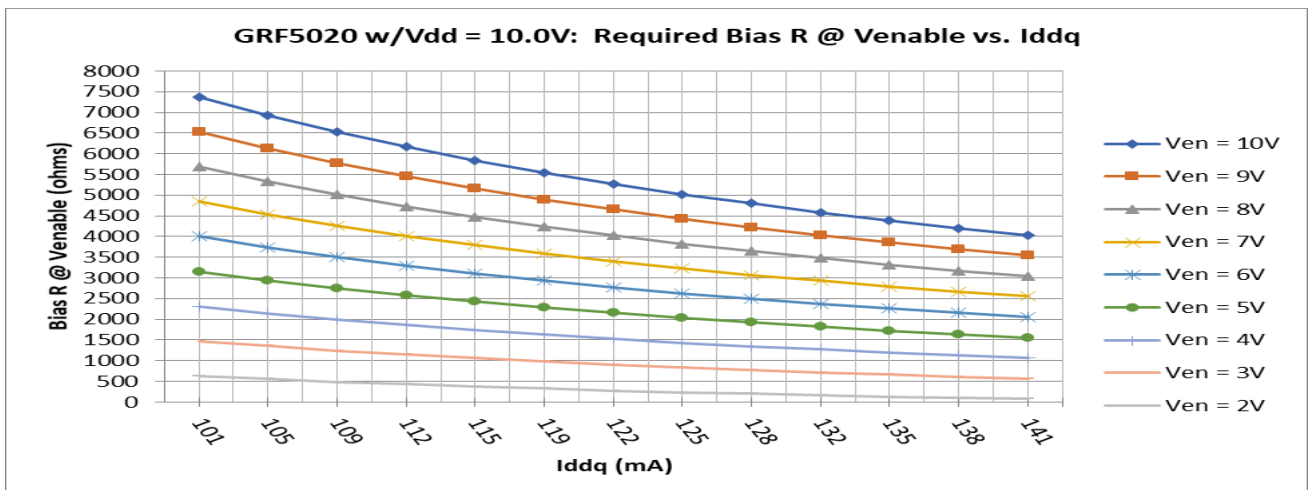
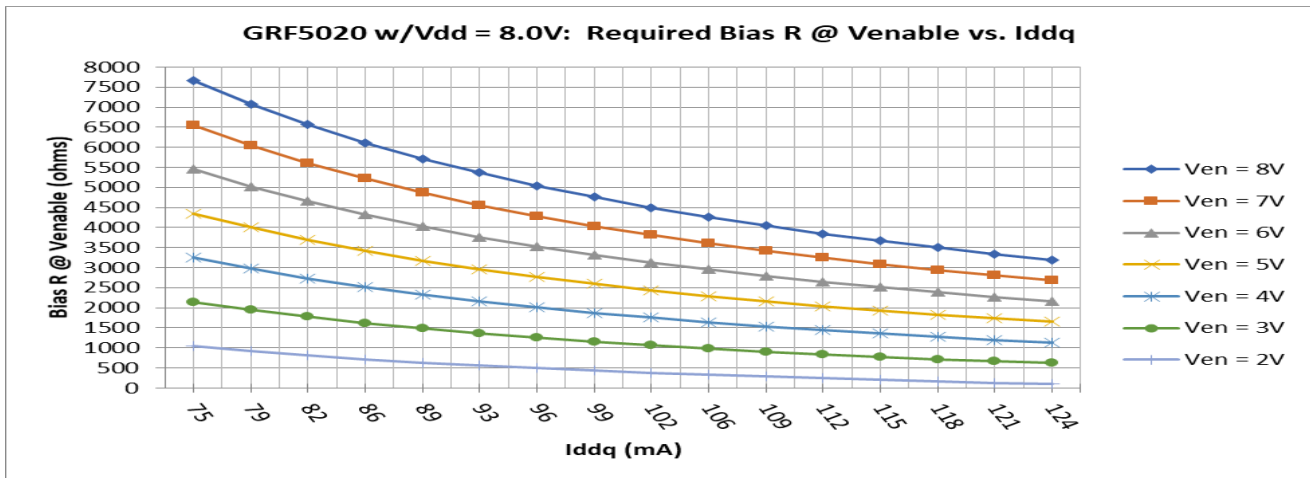
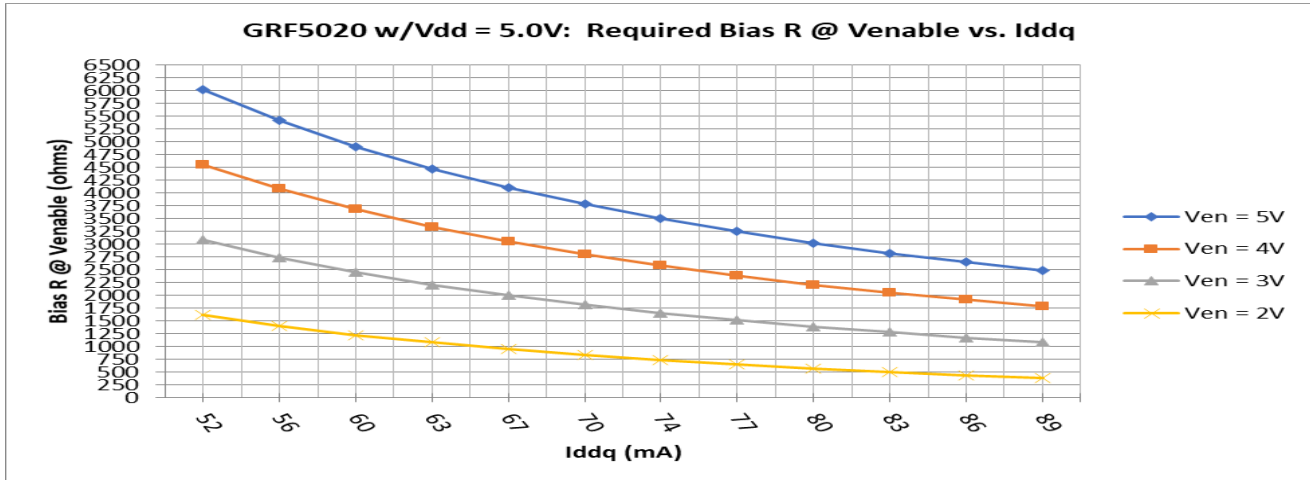

Guerrilla RF Proprietary Information. Guerrilla RF™ and the composite logo of Guerrilla RF™ are trademarks of Guerrilla RF, Inc. ©2014 Guerrilla RF, Inc. All rights reserved.



Released

GRF5020

30.5 dBm Power-LNA™
Tuning Range: 0.1 – 6.0 GHz

Data Sheet Release Status:	Notes
Advance	S-parameter and NF data based on EM simulations for the fully packaged device using foundry supplied transistor s-parameters. Linearity estimates based on device size, bias condition and experience with related devices.
Preliminary	All data based on evaluation board measurements in the Guerrilla RF Applications Lab.
Released	All data based on device qualification data. Typically, this data is nearly identical to the data found in the preliminary version. Max and min values for key RF parameters are included.

Information in this datasheet is specific to the Guerrilla RF, Inc. ("Guerrilla RF") product identified.

This datasheet, including the information contained in it, is provided by Guerrilla RF as a service to its customers and may be used for informational purposes only by the customer. Guerrilla RF assumes no responsibility for errors or omissions on this datasheet or the information contained herein. Information provided is believed to be accurate and reliable, however, no responsibility is assumed by Guerrilla RF for its use, nor for any infringement of patents, or other rights of third parties, resulting from its use. Guerrilla RF assumes no liability for any datasheet, datasheet information, materials, products, product information, or other information provided hereunder, including the sale, distribution, reproduction or use of Guerrilla RF products, information or materials.

No license, whether express, implied, by estoppel, by implication or otherwise is granted by this datasheet for any intellectual property of Guerrilla RF, or any third party, including without limitation, patents, patent rights, copyrights, trademarks and trade secrets. All rights are reserved by Guerrilla RF.

All information herein, products, product information, datasheets, and datasheet information are subject to change and availability without notice. Guerrilla RF reserves the right to change component circuitry, recommended application circuitry and specifications at any time without prior notice. Guerrilla RF may further change its datasheet, product information, documentation, products, services, specifications or product descriptions at any time, without notice. Guerrilla RF makes no commitment to update any materials or information and shall have no responsibility whatsoever for conflicts, incompatibilities, or other difficulties arising from any future changes.

GUERRILLA RF INFORMATION, PRODUCTS, PRODUCT INFORMATION, DATASHEETS AND DATASHEET INFORMATION ARE PROVIDED "AS IS" AND WITHOUT WARRANTY OF ANY KIND, WHETHER EXPRESS, IMPLIED, STATUTORY, OR OTHERWISE, INCLUDING FITNESS FOR A PARTICULAR PURPOSE OR USE, MERCHANTABILITY, PERFORMANCE, QUALITY OR NON-INFRINGEMENT OF ANY INTELLECTUAL PROPERTY RIGHT; ALL SUCH WARRANTIES ARE HEREBY EXPRESSLY DISCLAIMED. GUERRILLA RF DOES NOT WARRANT THE ACCURACY OR COMPLETENESS OF THE INFORMATION, TEXT, GRAPHICS OR OTHER ITEMS CONTAINED WITHIN THESE MATERIALS. GUERRILLA RF SHALL NOT BE LIABLE FOR ANY DAMAGES, INCLUDING BUT NOT LIMITED TO ANY SPECIAL, INDIRECT, INCIDENTAL, STATUTORY, OR CONSEQUENTIAL DAMAGES, INCLUDING WITHOUT LIMITATION, LOST REVENUES OR LOST PROFITS THAT MAY RESULT FROM THE USE OF THE MATERIALS OR INFORMATION, WHETHER OR NOT THE RECIPIENT OF MATERIALS HAS BEEN ADVISED OF THE POSSIBILITY OF SUCH DAMAGE.

Customers are solely responsible for their use of Guerrilla RF products in the Customer's products and applications or in ways which deviate from Guerrilla RF's published specifications, either intentionally or as a result of design defects, errors, or operation of products outside of published parameters or design specifications. Customers should include design and operating safeguards to minimize these and other risks. Guerrilla RF assumes no liability or responsibility for applications assistance, customer product design, or damage to any equipment resulting from the use of Guerrilla RF products outside of stated published specifications or parameters.