



Temperature Logger *i*Button with 8KB Data-Log Memory

DS1922L/DS1922T

General Description

The DS1922L/DS1922T temperature logger *i*Buttons® are rugged, self-sufficient systems that measure temperature and record the result in a protected memory section. The recording is done at a user-defined rate. A total of 8192 8-bit readings or 4096 16-bit readings, taken at equidistant intervals ranging from 1s to 273hr, can be stored. Additionally, 512 bytes of SRAM store application-specific information and 64 bytes store calibration data. A mission to collect data can be programmed to begin immediately, after a user-defined delay, or after a temperature alarm. Access to the memory and control functions can be password protected. The DS1922L/DS1922T are configured and communicate with a host-computing device through the serial 1-Wire® protocol, which requires only a single data lead and a ground return. Each DS1922L/DS1922T is factory lasered with a guaranteed unique 64-bit registration number that allows for absolute traceability. The durable stainless-steel package is highly resistant to environmental hazards such as dirt, moisture, and shock. Accessories permit the DS1922L/DS1922T to be mounted on almost any object, including containers, pallets, and bags.

Applications

High-Temperature Logging (Process Monitoring, Industrial Temperature Monitoring)

Temperature Logging in Cold Chain, Food Safety, Bio Science, and Pharmaceutical and Medical Products

Features

- ◆ Automatically Wakes Up, Measures Temperature, and Stores Values in 8KB of Data-Log Memory in 8-Bit or 16-Bit Format
- ◆ Digital Thermometer Measures Temperature with 8-Bit (0.5°C) or 11-Bit (0.0625°C) Resolution
- ◆ Accuracy of ±0.5°C from -10°C to +65°C (DS1922L), ± 0.5°C from +20°C to +75°C (DS1922T), with Software Corrections
- ◆ Water Resistant or Waterproof if Placed Inside DS9107 *i*Button Capsule (Exceeds Water Resistant 3 ATM Requirements)
- ◆ Sampling Rate from 1s Up to 273hr
- ◆ Programmable High and Low Trip Points for Temperature Alarms
- ◆ Programmable Recording Start Delay After Elapsed Time or Upon a Temperature Alarm Trip Point
- ◆ Quick Access to Alarmed Devices Through 1-Wire Conditional Search Function
- ◆ 512 Bytes of General-Purpose Memory Plus 64 Bytes of Calibration Memory

- ◆ Two-Level Password Protection of All Memory and Configuration Registers
- ◆ Communicates to Host with a Single Digital Signal Up to 15.4kbps at Standard Speed or Up to 125kbps in Overdrive Mode Using 1-Wire Protocol
- ◆ Operating Temperature Range: DS1922L: -40°C to +85°C; DS1922T: 0°C to +125°C

Common *i*Button Features

- ◆ Digital Identification and Information by Momentary Contact
- ◆ Unique Factory-Lasered 64-Bit Registration Number Ensures Error-Free Device Selection and Absolute Traceability Because No Two Parts Are Alike
- ◆ Built-In Multidrop Controller for 1-Wire Net
- ◆ Chip-Based Data Carrier Compactly Stores Information
- ◆ Data Can Be Accessed While Affixed to Object
- ◆ Button Shape is Self-Aligning with Cup-Shaped Probes
- ◆ Durable Stainless-Steel Case Engraved with Registration Number Withstands Harsh Environments
- ◆ Easily Affixed with Self-Stick Adhesive Backing, Latched by Its Flange, or Locked with a Ring Pressed Onto Its Rim
- ◆ Presence Detector Acknowledges When Reader First Applies Voltage
- ◆ Meets UL 913, 5th Ed., Rev. 1997-02-24; Inherently Safe Apparatus: Approved Under Entity Concept for Use in Class I, Division 1, Group A, B, C, and D Locations

Ordering Information

PART	TEMP RANGE	PIN-PACKAGE
DS1922L-F5#	-40°C to +85°C	F5 <i>i</i> Button
DS1922T-F5#	0°C to +125°C	F5 <i>i</i> Button

#Denotes a RoHS-compliant device that may include lead(Pb) that is exempt under the RoHS requirements.

Examples of Accessories

PART	ACCESSORY
DS9096P	Self-Stick Adhesive Pad
DS9101	Multipurpose Clip
DS9093RA	Mounting Lock Ring
DS9093A	Snap-in FOB
DS9092	<i>i</i> Button Probe

Pin Configuration appears at end of data sheet.

*i*Button and 1-Wire are registered trademarks of Maxim Integrated Products, Inc.



Maxim Integrated Products 1

For pricing, delivery, and ordering information, please contact Maxim Direct at 1-888-629-4642, or visit Maxim's website at www.maxim-ic.com.

Temperature Logger *i*Button with 8KB Data-Log Memory

ABSOLUTE MAXIMUM RATINGS

IO Voltage Range to GND	-0.3V to +6V	Junction Temperature	+150°C
IO Sink Current.....	20mA	Storage Temperature Range*	
Operating Temperature Range		DS1922L.....	-40°C to +85°C*
DS1922L	-40°C to +85°C	DS1922T	0°C to +125°C*
DS1922T	0°C to +125°C		

*Storage or operation above +50°C significantly reduces battery life.

Stresses beyond those listed under “Absolute Maximum Ratings” may cause permanent damage to the device. These are stress ratings only, and functional operation of the device at these or any other conditions beyond those indicated in the operational sections of the specifications is not implied. Exposure to absolute maximum rating conditions for extended periods may affect device reliability.

ELECTRICAL CHARACTERISTICS

(V_{PUP} = +3.0V to +5.25V.)

PARAMETER	SYMBOL	CONDITIONS	MIN	TYP	MAX	UNITS
Operating Temperature	T _A	DS1922L (Note 1)	-40		+85	°C
		DS1922T (Note 1)	0		+125	
IO PIN: GENERAL DATA						
1-Wire Pullup Resistance	R _{PUP}	(Notes 2, 3)			2.2	kΩ
Input Capacitance	C _{IO}	(Note 4)		100	800	pF
Input Load Current	I _L	IO pin at V _{PUP}		6	10	μA
High-to-Low Switching Threshold	V _{TL}	(Notes 5, 6)	0.4		3.2	V
Input Low Voltage	V _{IL}	(Notes 2, 7)			0.3	V
Low-to-High Switching Threshold	V _{TH}	(Notes 5, 8)	0.7		3.4	V
Switching Hysteresis	V _{HY}	(Note 9)	0.09		N/A	V
Output Low Voltage	V _{OL}	At 4mA (Note 10)			0.4	V
Recovery Time (Note 2)	t _{REC}	Standard speed, R _{PUP} = 2.2kΩ	5			μs
		Overdrive speed, R _{PUP} = 2.2kΩ	2			
		Overdrive speed, directly prior to reset pulse; R _{PUP} = 2.2kΩ	5			
Rising-Edge Hold-Off Time	t _{REH}	(Note 11)	0.6		2.0	μs
Time-Slot Duration (Note 2)	t _{SLOT}	Standard speed	65			μs
		Overdrive speed, V _{PUP} > 4.5V	8			
		Overdrive speed (Note 12)	9.5			
IO PIN: 1-Wire RESET, PRESENCE-DETECT CYCLE						
Reset Low Time (Note 2)	t _{RSTL}	Standard speed, V _{PUP} > 4.5V	480		720	μs
		Standard speed (Note 12)	690		720	
		Overdrive speed, V _{PUP} > 4.5V	48		80	
		Overdrive speed (Note 12)	70		80	
Presence-Detect High Time	t _{PDH}	Standard speed, V _{PUP} > 4.5V	15		60	μs
		Standard speed (Note 12)	15		63.5	
		Overdrive speed (Note 12)	2		7	
Presence-Detect Fall Time (Note 13)	t _{FPD}	Standard speed, V _{PUP} > 4.5V	1.5		5	μs
		Standard speed	1.5		8	
		Overdrive speed	0.15		1	

Temperature Logger *i*Button with 8KB Data-Log Memory

DS1922L/DS1922T

ELECTRICAL CHARACTERISTICS (continued)

($V_{PUP} = +3.0V$ to $+5.25V$.)

PARAMETER	SYMBOL	CONDITIONS	MIN	TYP	MAX	UNITS
Presence-Detect Low Time	t_{PDL}	Standard speed, $V_{PUP} > 4.5V$	60		240	μs
		Standard speed (Note 12)	60		287	
		Overdrive speed, $V_{PUP} > 4.5V$ (Note 12)	7		24	
		Overdrive speed (Note 12)	7		28	
Presence-Detect Sample Time (Note 2)	t_{MSP}	Standard speed, $V_{PUP} > 4.5V$	65		75	μs
		Standard speed	71.5		75	
		Overdrive speed	8		9	
IO PIN: 1-Wire WRITE						
Write-Zero Low Time (Notes 2, 14)	t_{WOL}	Standard speed	60		120	μs
		Overdrive Speed, $V_{PUP} > 4.5V$ (Note 12)	6		12	
		Overdrive speed (Note 12)	7.5		12	
Write-One Low Time (Notes 2, 14)	t_{W1L}	Standard speed	5		15	μs
		Overdrive speed	1		1.95	
IO PIN: 1-Wire READ						
Read Low Time (Notes 2, 15)	t_{RL}	Standard speed	5		15 - δ	μs
		Overdrive speed	1		1.95 - δ	
Read Sample Time (Notes 2, 15)	t_{MSR}	Standard speed	$t_{RL} + \delta$		15	μs
		Overdrive speed	$t_{RL} + \delta$		1.95	
REAL-TIME CLOCK						
Accuracy			See RTC Accuracy graphs			min/month
Frequency Deviation	ΔF	-40°C to +85°C	-300		+60	PPM
		0°C to +125°C	-600		+60	
TEMPERATURE CONVERTER						
Conversion Time (Note 16)	t_{CONV}	8-bit mode	30		75	ms
		16-bit mode (11 bits)	240		600	
Thermal Response Time Constant (Note 17)	τ_{RESP}	<i>i</i> Button package	130			s
Conversion Error Without Software Correction	$\Delta\theta$	(Notes 18, 19)	See Temperature Accuracy graphs			°C
Conversion Error with Software Correction	$\Delta\theta$	(Notes 19, 20)	See Temperature Accuracy graphs			°C

Note 1: Guaranteed by design, not production tested to -40°C or +125°C.

Note 2: System requirement.

Note 3: Maximum allowable pullup resistance is a function of the number of 1-Wire devices in the system and 1-Wire recovery times. The specified value here applies to systems with only one device and with the minimum 1-Wire recovery times. For more heavily loaded systems, an active pullup such as that found in the DS2480B may be required.

Note 4: Capacitance on the data pin could be 800pF when V_{PUP} is first applied. If a 2.2k Ω resistor is used to pull up the data line, 2.5 μs after V_{PUP} has been applied, the parasite capacitance does not affect normal communications.

Note 5: V_{TL} and V_{TH} are functions of the internal supply voltage, which is a function of V_{PUP} and the 1-Wire recovery times. The V_{TH} and V_{TL} maximum specifications are valid at $V_{PUP} = 5.25V$. In any case, $V_{TL} < V_{TH} < V_{PUP}$.

Note 6: Voltage below which, during a falling edge on IO, a logic 0 is detected.

Temperature Logger *i*Button with 8KB Data-Log Memory

ELECTRICAL CHARACTERISTICS (continued)

($V_{PUP} = +3.0V$ to $+5.25V$.)

- Note 7:** The voltage on IO must be less than or equal to V_{ILMAX} whenever the master drives the line low.
- Note 8:** Voltage above which, during a rising edge on IO, a logic 1 is detected.
- Note 9:** After V_{TH} is crossed during a rising edge on IO, the voltage on IO must drop by V_{HY} to be detected as logic 0.
- Note 10:** The I-V characteristic is linear for voltages less than 1V.
- Note 11:** The earliest recognition of a negative edge is possible at t_{REH} after V_{TH} has been previously reached.
- Note 12:** Numbers in **bold** are **not** in compliance with the published *i*Button standards. See the *Comparison Table*.
- Note 13:** Interval during the negative edge on IO at the beginning of a presence-detect pulse between the time at which the voltage is 90% of V_{PUP} and the time at which the voltage is 10% of V_{PUP} .
- Note 14:** ϵ in Figure 13 represents the time required for the pullup circuitry to pull the voltage on IO up from V_{IL} to V_{TH} . The actual maximum duration for the master to pull the line low is $t_{W1LMAX} + t_F - \epsilon$ and $t_{W0LMAX} + t_F - \epsilon$, respectively.
- Note 15:** δ in Figure 13 represents the time required for the pullup circuitry to pull the voltage on IO up from V_{IL} to the input-high threshold of the bus master. The actual maximum duration for the master to pull the line low is $t_{RLMAX} + t_F$.
- Note 16:** To conserve battery power, use 8-bit temperature logging whenever possible.
- Note 17:** This number was derived from a test conducted by Cemagref in Antony, France, in July 2000: www.cemagref.fr/English/index.htm Test Report No. E42.
- Note 18:** Includes $+0.1/-0.2^\circ C$ calibration chamber measurement uncertainty.
- Note 19: Warning:** Not for use as the sole method of measuring or tracking temperature in products and articles that could affect the health or safety of persons, plants, animals, or other living organisms, including but not limited to foods, beverages, pharmaceuticals, medications, blood and blood products, organs, flammable, and combustible products. User shall assure that redundant (or other primary) methods of testing and determining the handling methods, quality, and fitness of the articles and products should be implemented. Temperature tracking with this product, where the health or safety of the aforementioned persons or things could be adversely affected, is only recommended when supplemental or redundant information sources are used. Data-logger products are 100% tested and calibrated at time of manufacture by Maxim to ensure that they meet all data sheet parameters, including temperature accuracy. User shall be responsible for proper use and storage of this product. As with any sensor-based product, user shall also be responsible for occasionally rechecking the temperature accuracy of the product to ensure it is still operating properly.
- Note 20:** Assumes using calibration memory with calibration equations for error compensation. Includes $+0.1/-0.2^\circ C$ calibration chamber measurement uncertainty. Guaranteed by design.

COMPARISON TABLE

PARAMETER	LEGACY VALUES				DS1922L/DS1922T VALUES			
	STANDARD SPEED (μs)		OVERDRIVE SPEED (μs)		STANDARD SPEED (μs)		OVERDRIVE SPEED (μs)	
	MIN	MAX	MIN	MAX	MIN	MAX	MIN	MAX
t_{SLOT} (including t_{REC})	61	(undefined)	7	(undefined)	65	(undefined)	9.5	(undefined)
t_{RSTL}	480	(undefined)	48	80	690	720	70	80
t_{PDH}	15	60	2	6	15	63.5	2	7
t_{PDL}	60	240	8	24	60	287	7	28
t_{WOL}	60	120	6	16	60	120	7.5	12

*Intentional change; longer recovery time requirement due to modified 1-Wire front-end.

Note: Numbers in **bold** are **not** in compliance with the published *i*Button standards.

*i*Button CAN PHYSICAL SPECIFICATION

SIZE	See the <i>Package Information</i> section.
WEIGHT	Ca. 3.3 grams
SAFETY	Meets UL 913, 5th Ed., Rev. 1997-02-24; Intrinsically Safe Apparatus, approval under Entity Concept for use in Class I, Division 1, Group A, B, C, and D Locations.

Temperature Logger *i*Button with 8KB Data-Log Memory

DS1922L Minimum Product Lifetime vs. Temperature, Slow Sampling

DS1922L/DS1922T

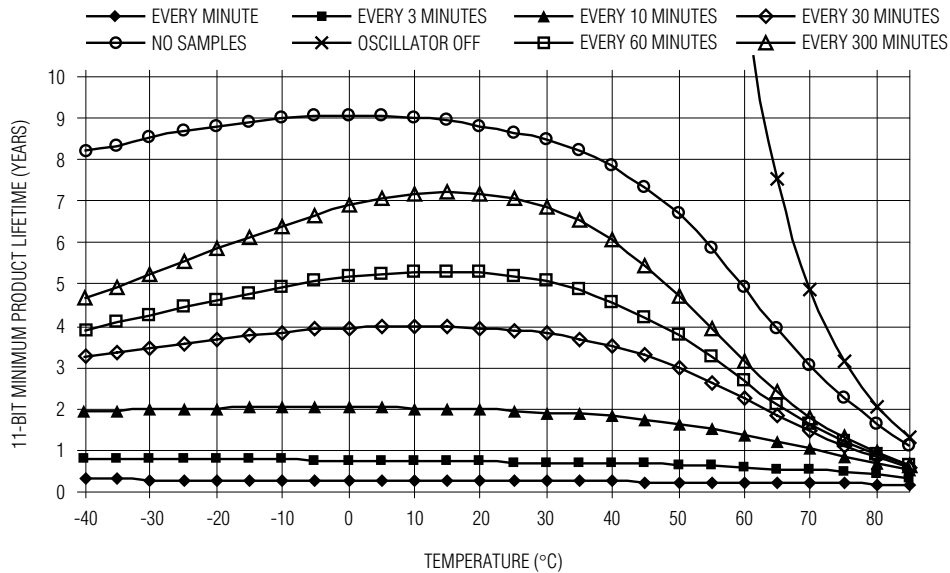
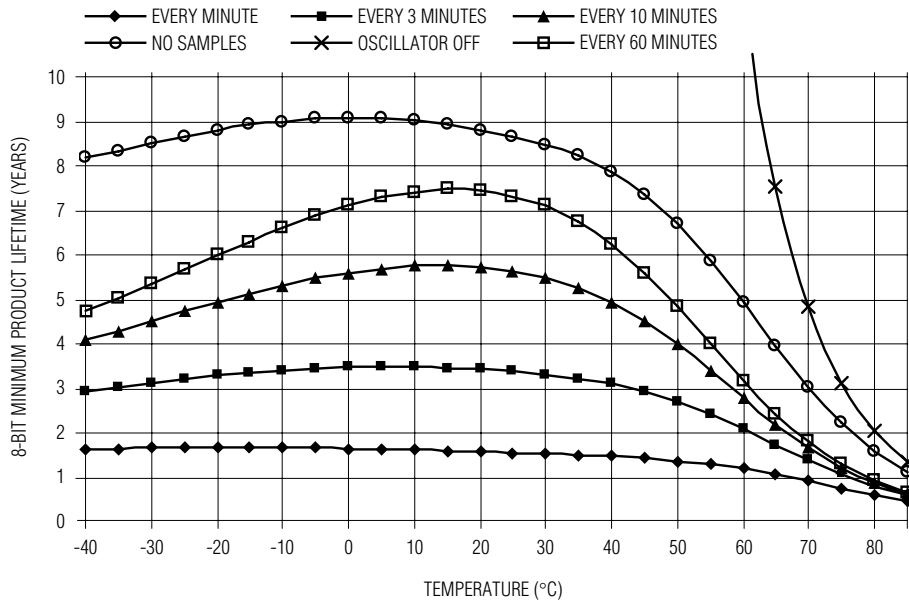

Temperature Logger *i*Button with 8KB Data-Log Memory

DS1922L Minimum Product Lifetime vs. Temperature, Fast Sampling

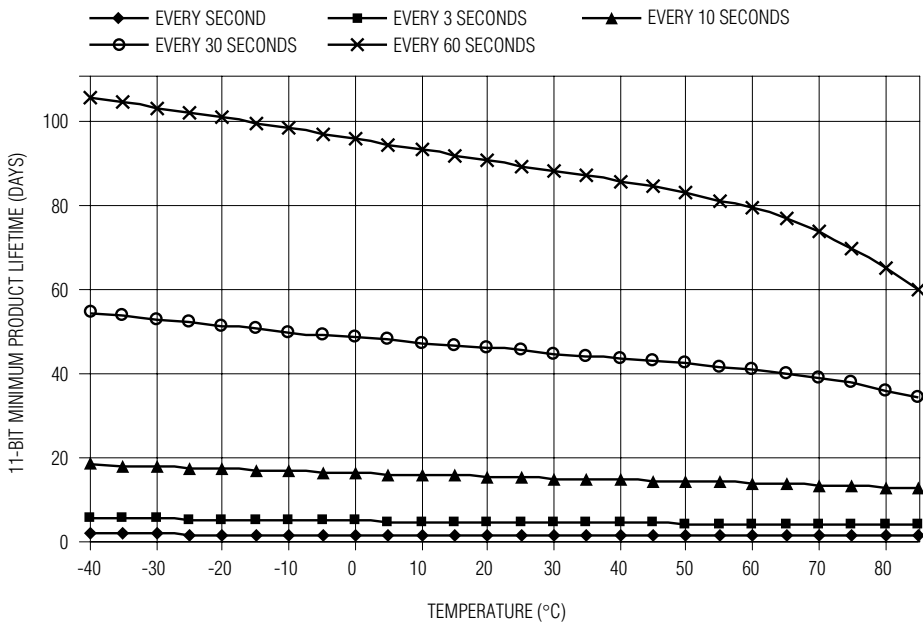
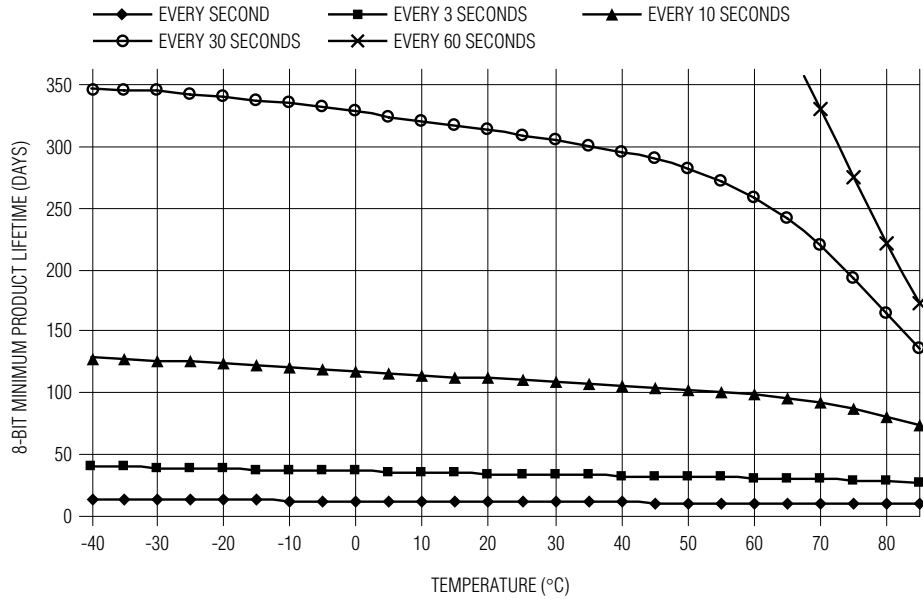

Temperature Logger iButton with 8KB Data-Log Memory

DS1922T Minimum Product Lifetime vs. Temperature, Slow Sampling

DS1922L/DS1922T

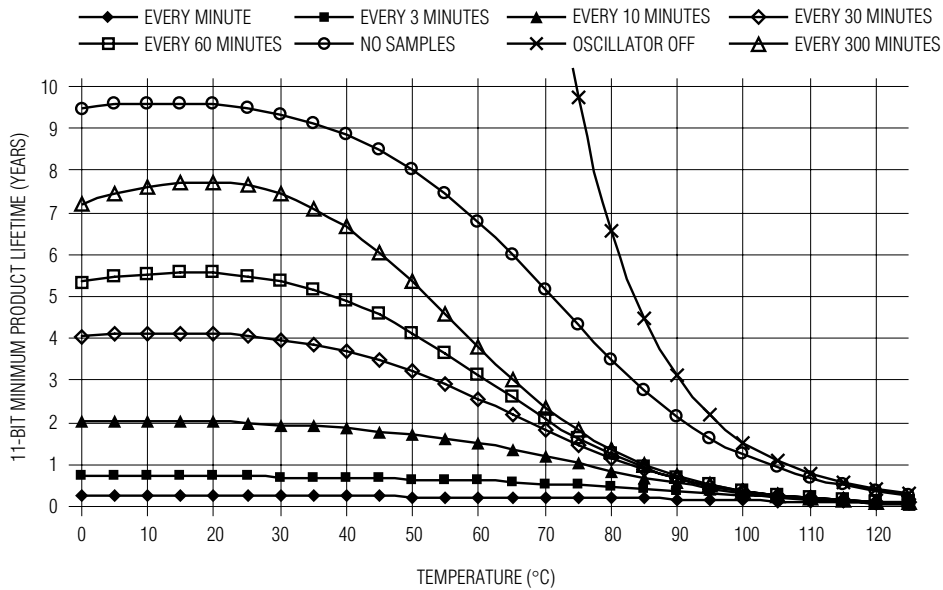
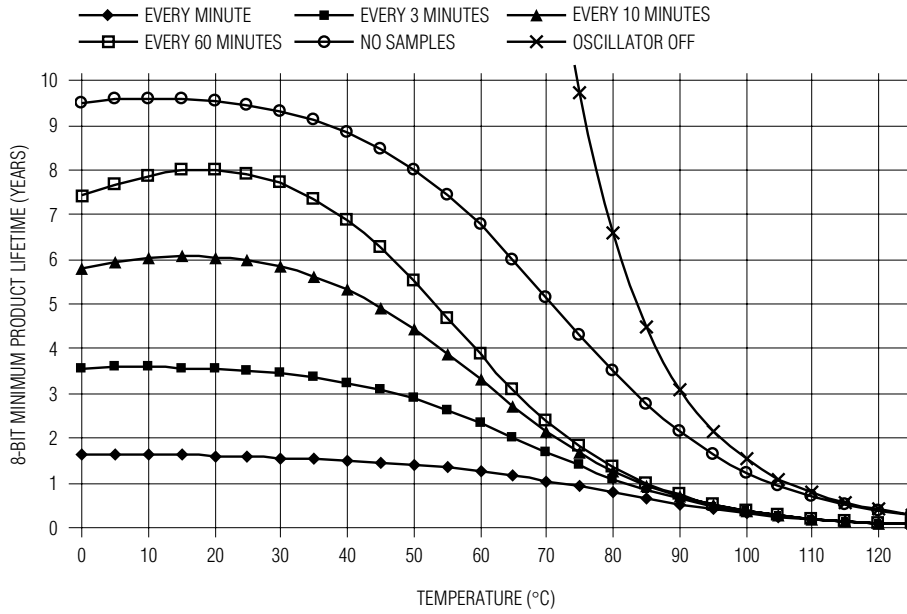

Temperature Logger *i*Button with 8KB Data-Log Memory

DS1922T Minimum Product Lifetime vs. Temperature, Fast Sampling

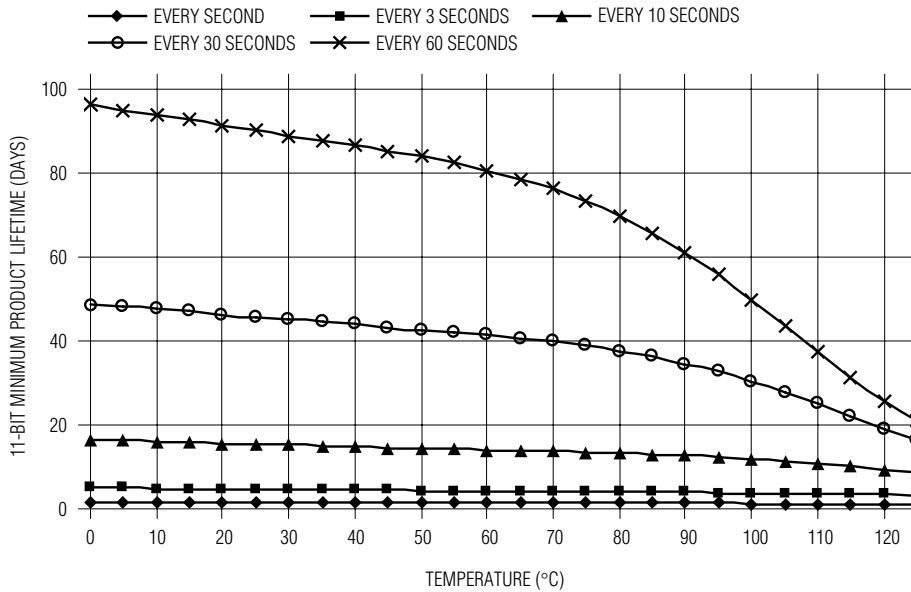
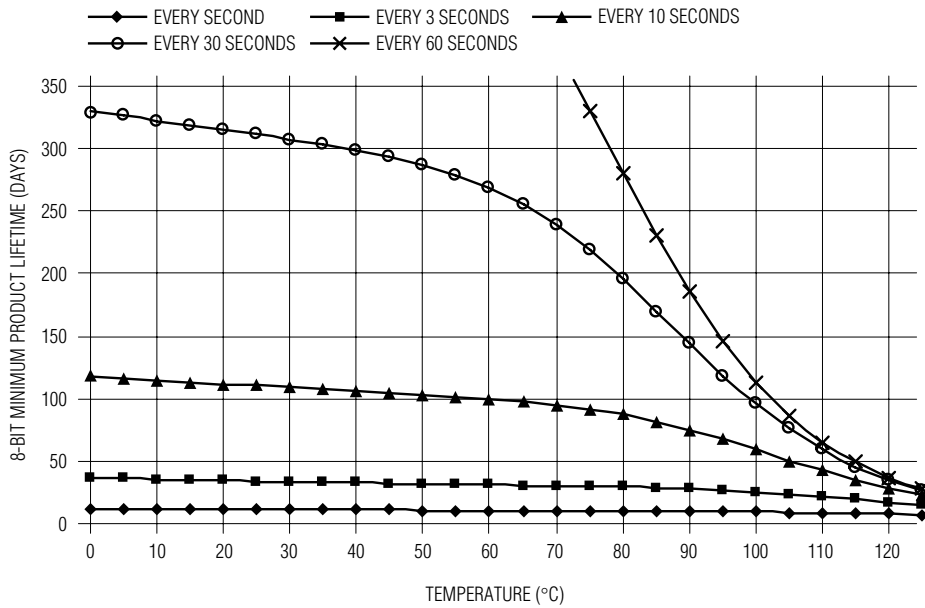

Temperature Logger *i*Button with 8KB Data-Log Memory

DS1922L Minimum Product Lifetime vs. Sample Rate

DS1922L/DS1922T

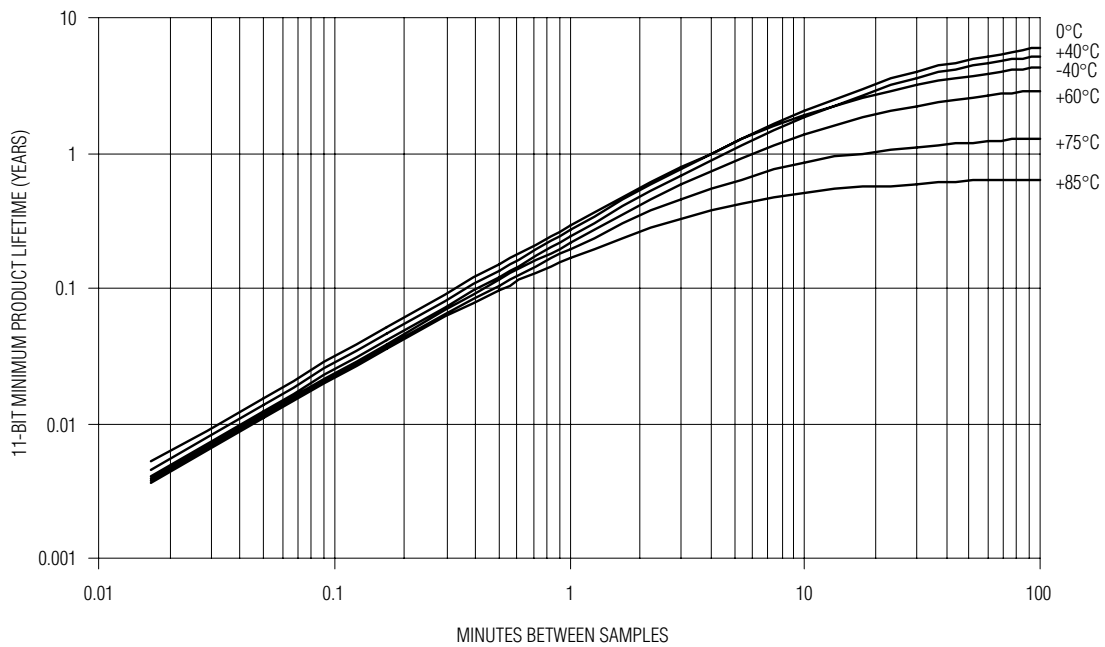
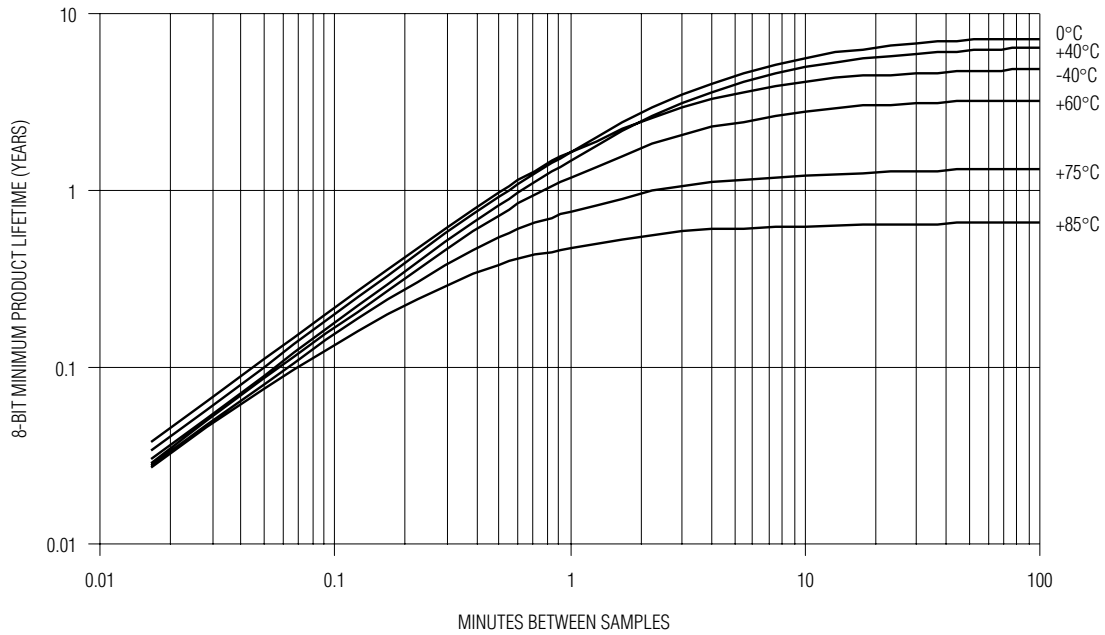

Temperature Logger *i*Button with 8KB Data-Log Memory

DS1922T Minimum Product Lifetime vs. Sample Rate

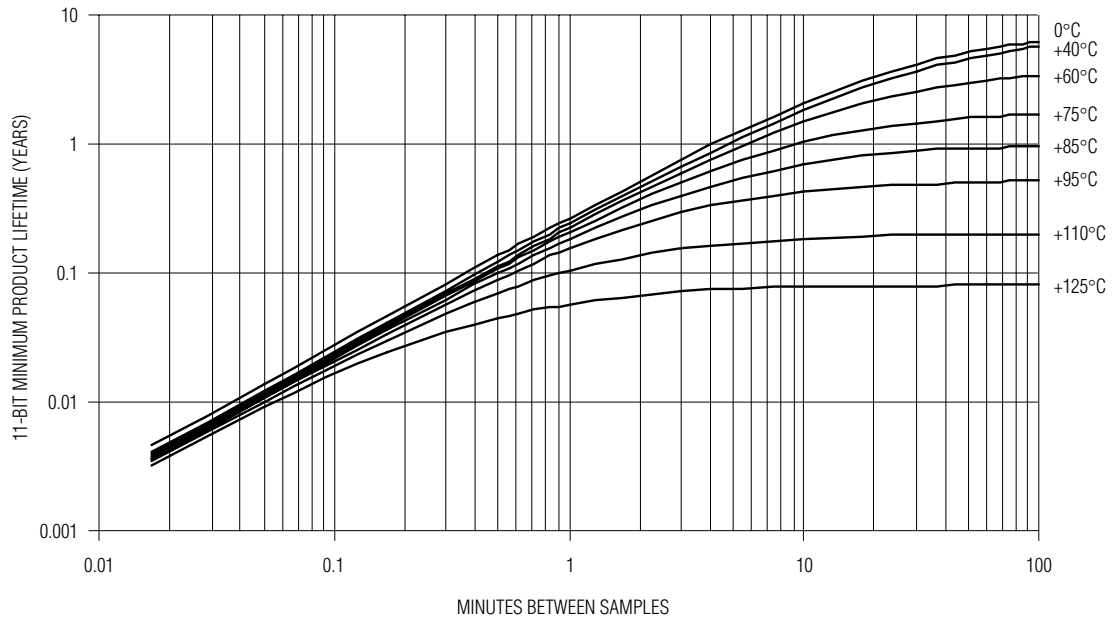
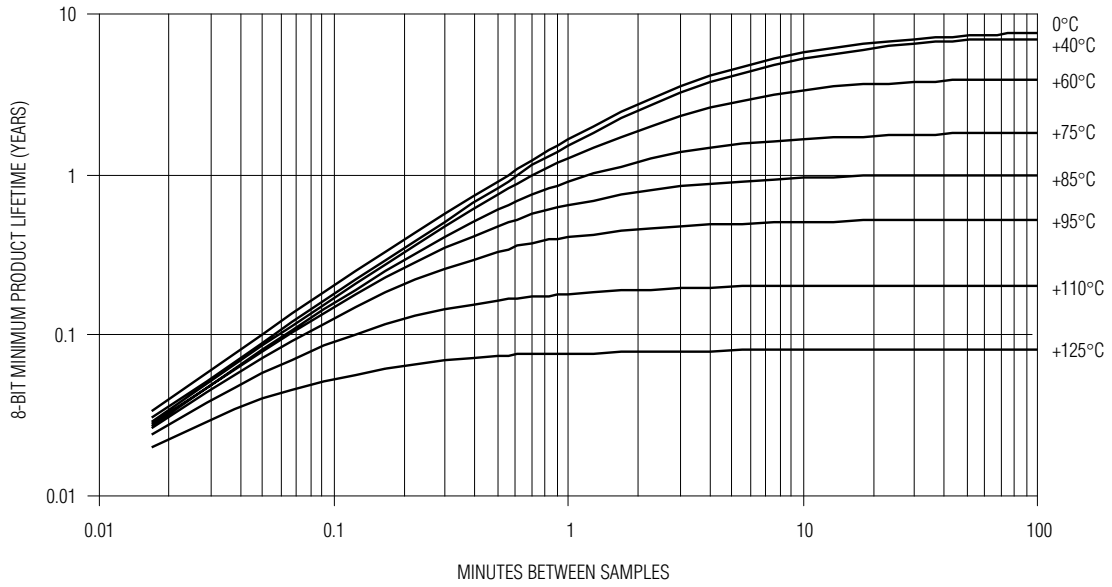

Temperature Logger iButton with 8KB Data-Log Memory

DS1922L Temperature Accuracy

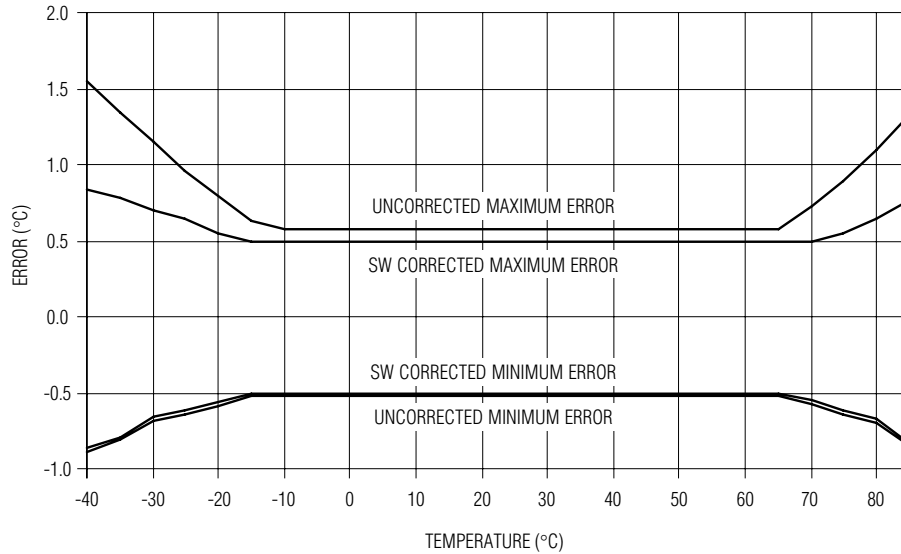

NOTE: THE GRAPHS ARE BASED ON 11-BIT DATA.

DS1922T Temperature Accuracy

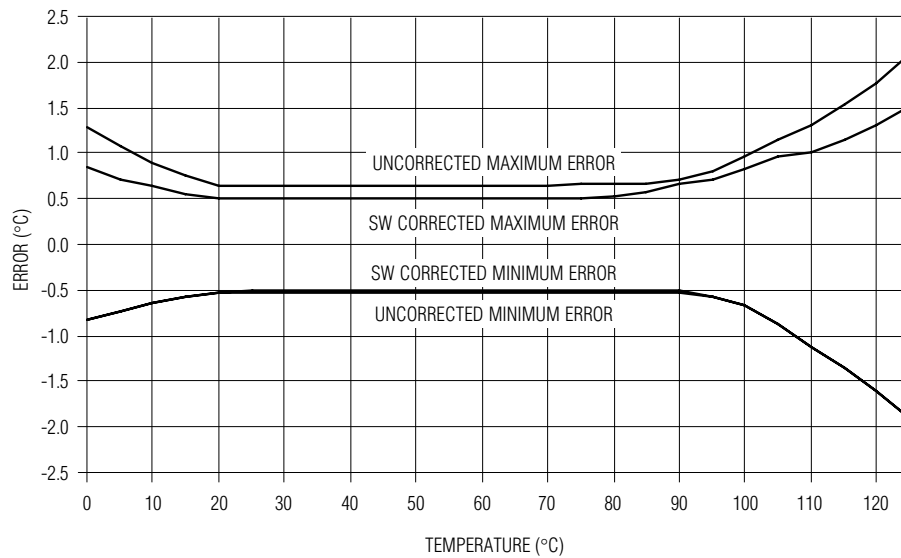

NOTE: THE GRAPHS ARE BASED ON 11-BIT DATA.

DS1922L/DS1922T

Temperature Logger *i*Button with 8KB Data-Log Memory

DS1922L RTC Accuracy (Typical)

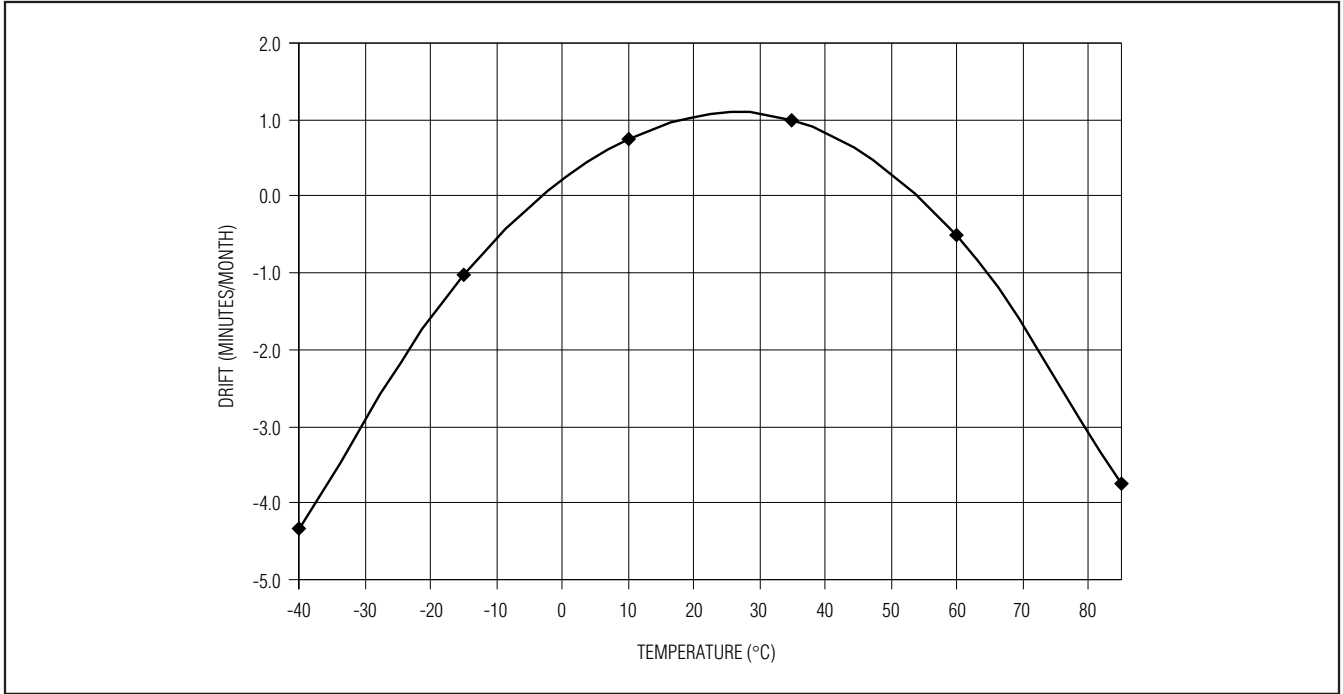

DS1922T RTC Accuracy (Typical)

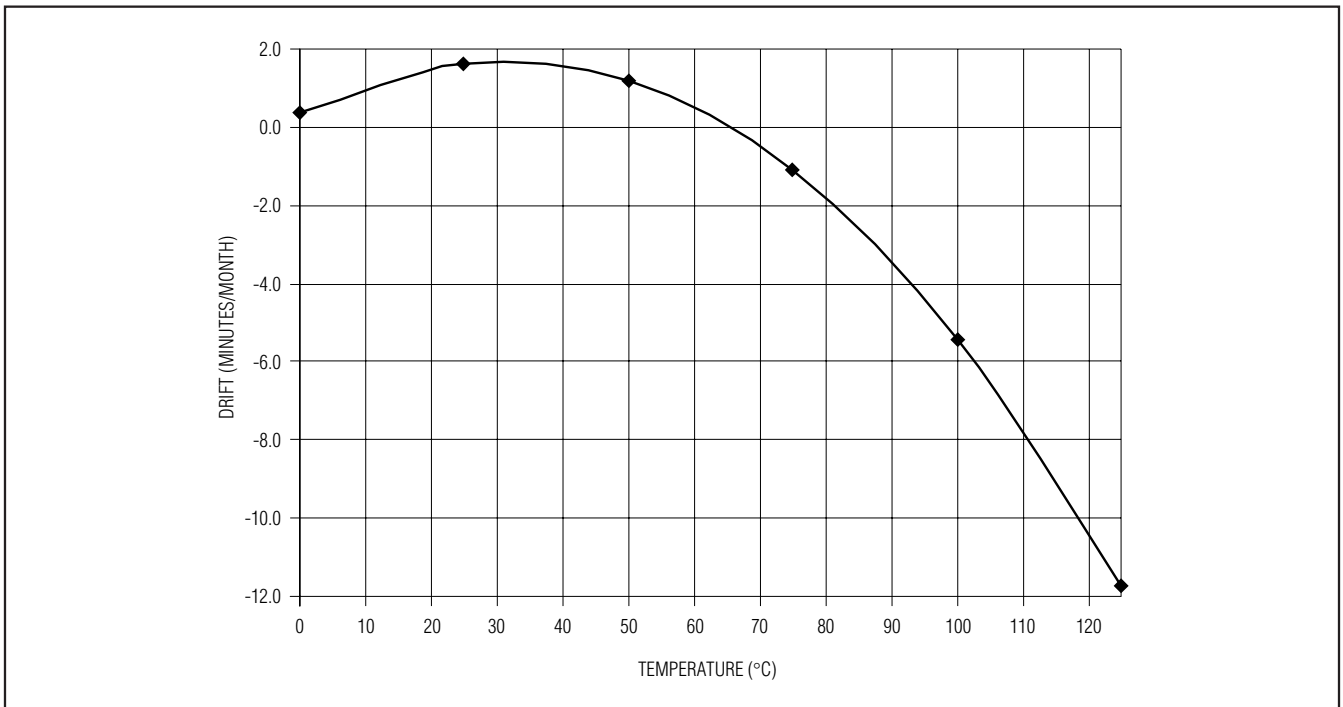

Temperature Logger *i*Button with 8KB Data-Log Memory

DS1922L/DS1922T

Detailed Description

The DS1922L is an ideal device to monitor for extended periods of time the temperature of any object it is attached to or shipped with, such as fresh produce, medical drugs and supplies, and for use in refrigerators and freezers. With its shifted temperature range, the DS1922T is suited to monitor processes that require temperatures close to the boiling point of water, such as pasteurization of food items. Note that the initial sealing level of the DS1922L/DS1922T achieves the equivalent of IP56. Aging and use conditions can degrade the integrity of the seal over time, so for applications with significant exposure to liquids, sprays, or other similar environments, it is recommended to place the DS1922L/DS1922T in the DS9107 *i*Button capsule. The DS9107 provides a watertight enclosure that has been rated to IP68 (refer to Application Note 4126: *Understanding the IP (Ingress Protection) Ratings of iButton Data Loggers and Capsules*). Software for setup and data retrieval through the 1-Wire interface is available for free download from the *i*Button website (www.ibutton.com). This software also includes drivers for the serial and USB port of a PC and routines to access the general-purpose memory for storing application-specific or equipment-specific data files.

All *i*Button data loggers are calibrated/validated against NIST traceable reference devices. Maxim offers a web application to generate validation certificates for the DS1922L, DS1922T, DS1922E, and DS1923 (temperature portion only) data loggers. Input is the *i*Button's ROM code (or list of codes) and the output is a validation certificate in PDF format. For more information, refer to Application Note 4629: *i*Button® Data-Logger Calibration and NIST Certificate FAQs.

Overview

The block diagram in Figure 1 shows the relationships between the major control and memory sections of the DS1922L/DS1922T. The devices have six main data components: 64-bit lasered ROM; 256-bit scratchpad; 512-byte general-purpose SRAM; two 256-bit register pages of timekeeping, control, status, and counter registers, and passwords; 64 bytes of calibration memory; and 8192 bytes of data-logging memory. Except for the ROM and the scratchpad, all other memory is arranged in a single linear address space. The data-logging memory, counter registers, and several other registers are read only for the user. Both register pages are write protected while the device is programmed for a mission. The password registers, one for a read password and another one for a read/write password, can only be written, never read.

Figure 2 shows the hierarchical structure of the 1-Wire protocol. The bus master must first provide one of the eight ROM function commands: Read ROM, Match ROM, Search ROM, Conditional Search ROM, Skip ROM, Overdrive-Skip ROM, Overdrive-Match ROM, or Resume. Upon completion of an Overdrive ROM command executed at standard speed, the device enters overdrive mode, where all subsequent communication occurs at a higher speed. The protocol required for these ROM function commands is described in Figure 11. After a ROM function command is successfully executed, the memory and control functions become accessible and the master can provide any one of the eight available commands. The protocol for these memory and control function commands is described in Figure 9. **All data is read and written least significant bit first.**

Parasite Power

The block diagram (Figure 1) shows the parasite-powered circuitry. This circuitry “steals” power whenever the IO input is high. IO provides sufficient power as long as the specified timing and voltage requirements are met. The advantages of parasite power are twofold: 1) By parasiting off this input, battery power is not consumed for 1-Wire ROM function commands, and 2) if the battery is exhausted for any reason, the ROM may still be read normally. The remaining circuitry of the DS1922 is solely operated by battery energy.

64-Bit Lasered ROM

Each DS1922L/DS1922T contains a unique ROM code that is 64 bits long. The first 8 bits are a 1-Wire family code. The next 48 bits are a unique serial number. The last 8 bits are a cyclic redundancy check (CRC) of the first 56 bits (see Figure 3 for details). The 1-Wire CRC is generated using a polynomial generator consisting of a shift register and XOR gates as shown in Figure 4. The polynomial is $X^8 + X^5 + X^4 + 1$. Additional information about the 1-Wire CRC is available in Application Note 27: *Understanding and Using Cyclic Redundancy Checks with Maxim iButton Products*.

The shift register bits are initialized to 0. Then, starting with the least significant bit of the family code, one bit at a time is shifted in. After the 8th bit of the family code has been entered, the serial number is entered. After the last bit of the serial number has been entered, the shift register contains the CRC value. Shifting in the 8 bits of CRC returns the shift register to all 0s.

Temperature Logger *i*Button with 8KB Data-Log Memory

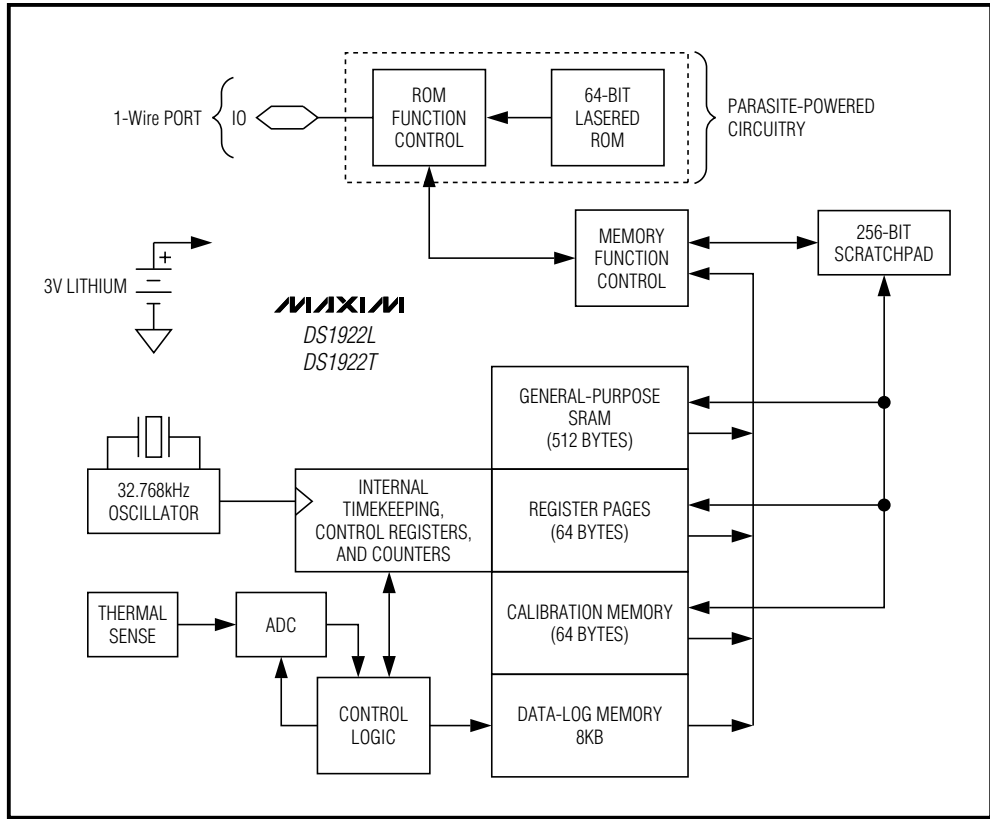

Figure 1. Block Diagram

Temperature Logger *i*Button with 8KB Data-Log Memory

DS1922L/DS1922T

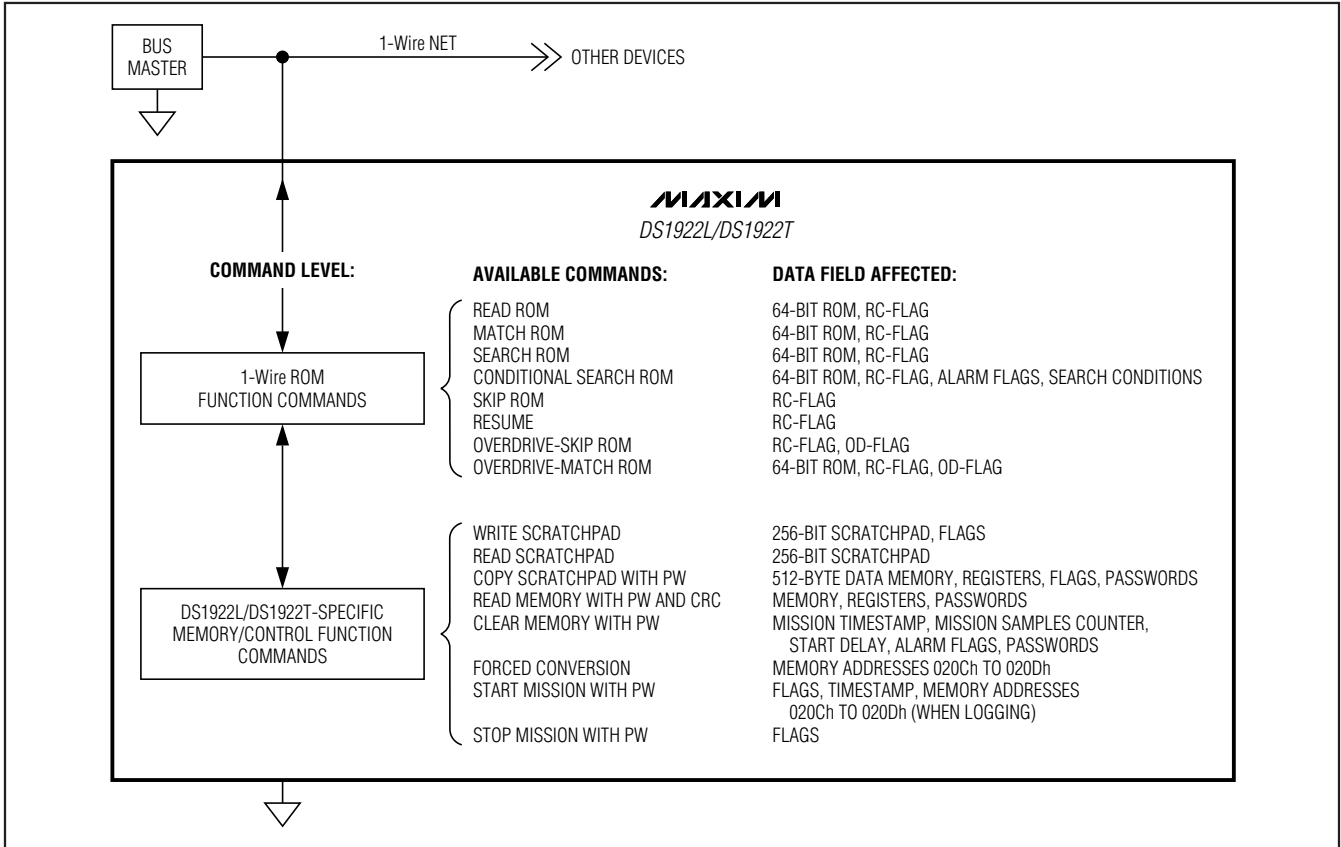

Figure 2. Hierarchical Structure for 1-Wire Protocol

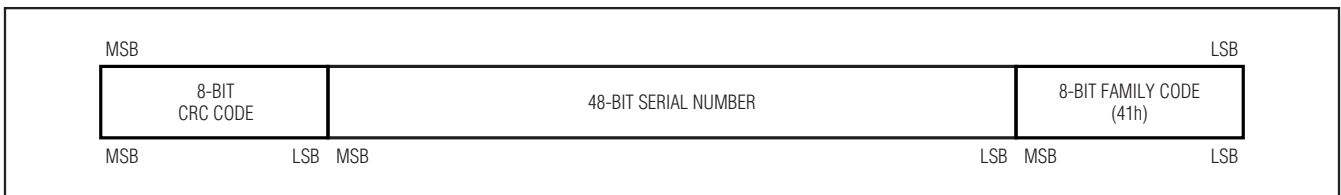

Figure 3. 64-Bit Lasered ROM

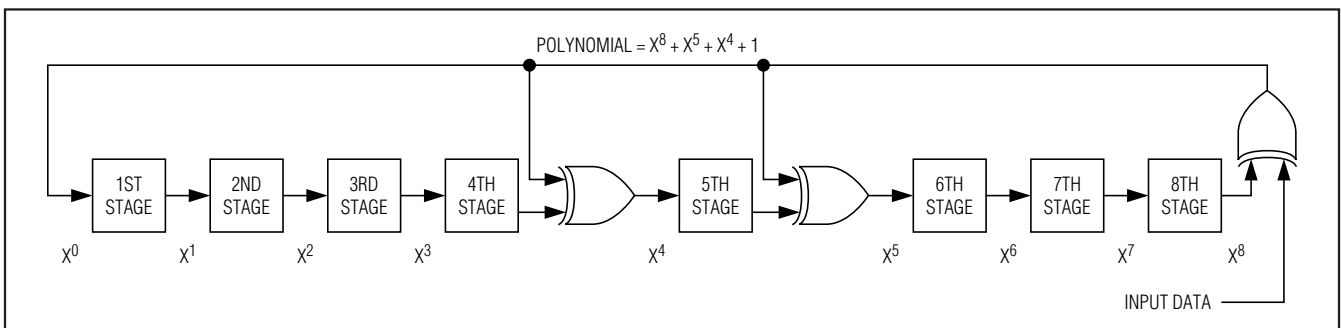

Figure 4. 1-Wire CRC Generator

Temperature Logger *i*Button with 8KB Data-Log Memory

Memory

Figure 5 shows the DS1922L/DS1922T memory map. Pages 0 to 15 contain 512 bytes of general-purpose SRAM. The various registers to set up and control the device fill pages 16 and 17, called register pages 1 and 2 (see Figure 6 for details). Pages 18 and 19 provide storage space for calibration data. They can alternatively be used as an extension of the general-purpose memory. The data-log logging memory starts at address 1000h (page 128) and extends over 256 pages. The memory pages 20 to 127 are reserved for future extensions. The scratchpad is an additional page that acts as a buffer when writing to the SRAM memory or the register pages. The data memory can be written at any time. The calibration memory holds data from the device calibration that can be used to further improve the accuracy of 11-bit temperature readings. See the

Software Correction Algorithm for Temperature section for details. The last byte of the calibration memory page stores an 8-bit CRC of the preceding 31 bytes. Page 19 is an exact copy of the data in page 18. While calibration memory can be overwritten by the user, this is not recommended. See the *Security by Password* section for ways to protect the memory. The access type for the register pages is register-specific and depends on whether the device is programmed for a mission. Figure 6 shows the details. The data-log memory is read only for the user. It is written solely under supervision of the on-chip control logic. Due to the special behavior of the write access logic (write scratchpad, copy scratchpad), it is recommended to only write full pages at a time. This also applies to the register pages and the calibration memory. See the *Address Registers and Transfer Status* section for details.

ADDRESS		
	32-BYTE INTERMEDIATE STORAGE SCRATCHPAD	
0000h TO 001Fh	32-BYTE GENERAL-PURPOSE SRAM (R/W)	PAGE 0
0020h TO 01FFh	GENERAL-PURPOSE SRAM (R/W)	PAGES 1 TO 15
0200h TO 021Fh	32-BYTE REGISTER PAGE 1	PAGE 16
0220h TO 023Fh	32-BYTE REGISTER PAGE 2	PAGE 17
0240h TO 025Fh	CALIBRATION MEMORY PAGE 1 (R/W)	PAGE 18
0260h TO 027Fh	CALIBRATION MEMORY PAGE 2 (R/W)	PAGE 19
0280h TO 0FFFh	(RESERVED FOR FUTURE EXTENSIONS)	PAGES 20 TO 127
1000h TO 2FFFh	DATA-LOG MEMORY (READ ONLY)	PAGES 128 TO 383

Figure 5. Memory Map

Temperature Logger *i*Button with 8KB Data-Log Memory

DS1922L/DS1922T

ADDRESS	BIT 7	BIT 6	BIT 5	BIT 4	BIT 3	BIT 2	BIT 1	BIT 0	FUNCTION	ACCESS*	
0200h	0	10 Seconds			Single Seconds				Real-Time Clock Registers	R/W	R
0201h	0	10 Minutes			Single Minutes						
0202h	0	12/24	20 Hour AM/PM	10 Hour	Single Hours						
0203h	0	0	10 Date		Single Date						
0204h	CENT	0	0	10 Months	Single Months						
0205h	10 Years				Single Years						
0206h	Low Byte								Sample Rate	R/W	R
0207h	0	0	High Byte								
0208h	Low Threshold								Temperature Alarms	R/W	R
0209h	High Threshold										
020Ah	(No Function with the DS1922L/DS1922T)								—	R/W	R
020Bh	(No Function with the DS1922L/DS1922T)										
020Ch	Low Byte			0	0	0	0	0	Latest Temperature	R	R
020Dh	High Byte										
020Eh	(No Function with the DS1922L/DS1922T)								—	R	R
020Fh	(No Function with the DS1922L/DS1922T)										
0210h	0	0	0	0	0	0	ETHA	ETLA	Temperature Alarm Enable	R/W	R
0211h	1	1	1	1	1	1	0	0	—	R/W	R
0212h	0	0	0	0	0	0	EHSS	EOSC	RTC Control	R/W	R
0213h	1	1	SUTA	RO	(X)	TLFS	0	ETL	Mission Control	R/W	R
0214h	BOR	1	1	1	0	0	THF	TLF	Alarm Status	R	R
0215h	1	1	0	WFTA	MEMCLR	0	MIP	0	General Status	R	R
0216h	Low Byte								Start Delay Counter	R/W	R
0217h	Center Byte										
0218h	High Byte										

**The left entry in the ACCESS column is valid between missions. The right entry shows the applicable access type while a mission is in progress.*

Figure 6. Register Pages Map

Temperature Logger *i*Button with 8KB Data-Log Memory

ADDRESS	BIT 7	BIT 6	BIT 5	BIT 4	BIT 3	BIT 2	BIT 1	BIT 0	FUNCTION	ACCESS*	
0219h	0	10 Seconds			Single Seconds				Mission Timestamp	R	R
021Ah	0	10 Minutes			Single Minutes						
021Bh	0	12/24	20 Hour AM/PM	10 Hour	Single Hours						
021Ch	0	0	10 Date		Single Date						
021Dh	CENT	0	0	10 Months	Single Months						
021Eh	10 Years			Single Years							
021Fh	(No Function; Reads 00h)								—	R	R
0220h	Low Byte								Mission Samples Counter	R	R
0221h	Center Byte										
0222h	High Byte										
0223h	Low Byte								Device Samples Counter	R	R
0224h	Center Byte										
0225h	High Byte										
0226h	Configuration Code								Flavor	R	R
0227h	EPW								PW Control	R/W	R
0228h	First Byte								Read Access Password	W	—
...	...										
022Fh	Eighth Byte										
0230h	First Byte								Full Access Password	W	—
...	...										
0237h	Eighth Byte										
0238h	(No Function; All These Bytes Read 00h)								—	R	R
...											
023Fh											

*The left entry in the ACCESS column is valid between missions. The right entry shows the applicable access type while a mission is in progress.

Figure 6. Register Pages Map (continued)

Temperature Logger iButton with 8KB Data-Log Memory

DS1922L/DS1922T

Detailed Register Descriptions

Timekeeping and Calendar

The RTC and calendar information is accessed by reading/writing the appropriate bytes in the register page, address 0200h to 0205h. For readings to be valid, all RTC registers must be read sequentially starting at address 0200h. Some of the RTC bits are set to 0. These bits always read 0 regardless of how they are written. The number representation of the RTC registers is binary-coded decimal (BCD) format.

The DS1922L/DS1922T's RTC can run in either 12hr or 24hr mode. Bit 6 of the Hours register (address 0202h) is defined as the 12hr- or 24hr-mode select bit. When high, the 12hr mode is selected. In the 12hr mode, bit 5 is the AM/PM bit with logic 1 being PM. In the 24hr mode, bit 5 is the 20hr bit (20hr to 23hr). The CENT bit, bit 7 of the Months register, can be written by the user. This bit changes its state when the years counter transitions from 99 to 00.

The calendar logic is designed to automatically compensate for leap years. For every year value that is

either 00 or a multiple of 4, the device adds a 29th of February. This works correctly up to (but not including) the year 2100.

Sample Rate

The content of the Sample Rate register (addresses 0206h, 0207h) specifies the time elapse (in seconds if EHSS = 1, or minutes if EHSS = 0) between two temperature-logging events. The sample rate can be any value from 1 to 16,383, coded as an unsigned 14-bit binary number. If EHSS = 1, the shortest time between logging events is 1s and the longest (sample rate = 3FFFh) is 4.55hr. If EHSS = 0, the shortest is 1min and the longest time is 273.05hr (sample rate = 3FFFh). The EHSS bit is located in the RTC Control register at address 0212h. It is important that the user sets the EHSS bit accordingly while setting the Sample Rate register. **Writing a sample rate of 0000h results in a sample rate = 0001h, causing the DS1922L/DS1922T to log the temperature either every minute or every second depending upon the state of the EHSS bit.**

RTC Registers Bitmap

ADDRESS	BIT 7	BIT 6	BIT 5	BIT 4	BIT 3	BIT 2	BIT 1	BIT 0
0200h	0	10 Seconds			Single Seconds			
0201h	0	10 Minutes			Single Minutes			
0202h	0	12/24	20 Hour AM/PM	10 Hour	Single Hours			
0203h	0	0	10 Date		Single Date			
0204h	CENT	0	0	10 Months	Single Months			
0205h	10 Years				Single Years			

Note: During a mission, there is only read access to these registers. Bit cells marked "0" always read 0 and cannot be written to 1.

Sample Rate Register Bitmap

ADDRESS	BIT 7	BIT 6	BIT 5	BIT 4	BIT 3	BIT 2	BIT 1	BIT 0
0206h	Sample Rate Low							
0207h	0	0	Sample Rate High					

Note: During a mission, there is only read access to these registers. Bit cells marked "0" always read 0 and cannot be written to 1.

Temperature Logger *i*Button with 8KB Data-Log Memory

Temperature Conversion

The DS1922L's temperature range begins at -40°C and ends at +85°C. The temperature range for the DS1922T begins at 0 and ends at +125°C. Temperature values are represented as an 8-bit or 16-bit unsigned binary number with a resolution of 0.5°C in 8-bit mode and 0.0625°C in 16-bit mode.

The higher temperature byte TRH is always valid. In 16-bit mode, only the three highest bits of the lower byte TRL are valid. The five lower bits all read 0. TRL is undefined if the device is in 8-bit temperature mode. An out-of-range temperature reading is indicated as 00h or 0000h when too cold and FFh or FFE0h when too hot.

With TRH and TRL representing the decimal equivalent of a temperature reading, the temperature value is calculated as:

$$\vartheta(^{\circ}\text{C}) = \text{TRH}/2 - 41 + \text{TRL}/512 \quad (\text{16-bit mode, TLFS} = 1, \text{ see address } 0213\text{h})$$

$$\vartheta(^{\circ}\text{C}) = \text{TRH}/2 - 41 \quad (\text{8-bit mode, TLFS} = 0, \text{ see address } 0213\text{h})$$

This equation is valid for converting temperature readings stored in the data-log memory as well as for data read from the Latest Temperature Conversion Result register. The “-41” applies to the DS1922L. For the DS1922T, use “-1” instead of “-41.”

To specify the temperature alarm thresholds, the previous equations are resolved to:

$$\text{TALM} = 2 \times \vartheta(^{\circ}\text{C}) + 82$$

The “+82” applies to the DS1922L. For the DS1922T, use “+2.” Because the temperature alarm threshold is only one byte, the resolution or temperature increment is limited to 0.5°C. The TALM value must be converted into hexadecimal format before it can be written to one of the Temperature Alarm Threshold registers (Low Alarm address 0208h; High Alarm address 0209h). Independent of the conversion mode (8-bit or 16-bit), only the most significant byte of a temperature conversion is used to determine whether an alarm is generated.

Latest Temperature Conversion Result Register Bitmap

ADDRESS	BIT 7	BIT 6	BIT 5	BIT 4	BIT 3	BIT 2	BIT 1	BIT 0	BYTE
020Ch	T2	T1	T0	0	0	0	0	0	TRL
020Dh	T10	T9	T8	T7	T6	T5	T4	T3	TRH

Table 1. Temperature Conversion Examples

MODE	TRH		TRL		$\vartheta(^{\circ}\text{C})$	
	HEX	DECIMAL	HEX	DECIMAL	DS1922L	DS1922T
8-Bit	54h	84	—	—	1.0	41.0
8-Bit	17h	23	—	—	-29.5	10.5
16-Bit	54h	84	00h	0	1.000	41.000
16-Bit	17h	23	60h	96	-29.3125	10.6875

Table 2. Temperature Alarm Threshold Examples

$\vartheta(^{\circ}\text{C})$	TALM (DS1922T)	
	HEX	DECIMAL
65.5	85h	133
30.0	3Eh	62

$\vartheta(^{\circ}\text{C})$	TALM (DS1922L)	
	HEX	DECIMAL
25.5	85h	133
-10.0	3Eh	62

Temperature Logger iButton with 8KB Data-Log Memory

Temperature Sensor Control Register Bitmap

ADDRESS	BIT 7	BIT 6	BIT 5	BIT 4	BIT 3	BIT 2	BIT 1	BIT 0
0210h	0	0	0	0	0	0	ETHA	ETLA

Note: During a mission, there is only read access to this register. Bits 2 to 7 have no function. They always read 0 and cannot be written to 1.

RTC Control Register Bitmap

ADDRESS	BIT 7	BIT 6	BIT 5	BIT 4	BIT 3	BIT 2	BIT 1	BIT 0
0212h	0	0	0	0	0	0	EHSS	EOSC

Note: During a mission, there is only read access to this register. Bits 2 to 7 have no function. They always read 0 and cannot be written to 1.

Temperature Sensor Alarm

The DS1922L/DS1922T have two Temperature Alarm Threshold registers (address 0208h, 0209h) to store values that determine whether a critical temperature has been reached. A temperature alarm is generated if the device measures an alarming temperature and the alarm signaling is enabled. The bits ETLA and ETHA that enable the temperature alarm are located in the Temperature Sensor Control register. The temperature alarm flags TLF and THF are found in the Alarm Status register at address 0214h.

Bit 1: Enable Temperature High Alarm (ETHA). This bit controls whether, during a mission, the temperature high alarm flag (THF) can be set, if a temperature conversion results in a value equal to or higher than the value in the Temperature High Alarm Threshold register. If ETHA is 1, temperature high alarms are enabled. If ETHA is 0, temperature high alarms are not generated.

Bit 0: Enable Temperature Low Alarm (ETLA). This bit controls whether, during a mission, the temperature low alarm flag (TLF) can be set, if a temperature conversion results in a value equal to or lower than the value in the Temperature Low Alarm Threshold register. If ETLA is 1, temperature low alarms are enabled. If ETLA is 0, temperature low alarms are not generated.

RTC Control

To minimize the power consumption of the DS1922L/DS1922T, the RTC oscillator should be turned off when these devices are not in use. The oscillator on/off bit is located in the RTC Control register. This register also includes the EHSS bit, which determines whether the sample rate is specified in seconds or minutes.

Bit 1: Enable High-Speed Sample (EHSS). This bit controls the speed of the sample rate counter. When set to logic 0, the sample rate is specified in minutes. When set to logic 1, the sample rate is specified in seconds.

Bit 0: Enable Oscillator (EOSC). This bit controls the crystal oscillator of the RTC. When set to logic 1, the oscillator starts. When written to logic 0, the oscillator stops and the device is in a low-power data-retention mode. This bit must be 1 for normal operation. A Forced Conversion or Start Mission command automatically starts the RTC by changing the EOSC bit to logic 1.

Temperature Logger *i*Button with 8KB Data-Log Memory

Mission Control Register Bitmap

ADDRESS	BIT 7	BIT 6	BIT 5	BIT 4	BIT 3	BIT 2	BIT 1	BIT 0
0213h	1	1	SUTA	RO	(X)	TLFS	0	ETL

Note: During a mission, there is only read access to this register. Bits 6 and 7 have no function. They always read 1 and cannot be written to 0. Bits 1 and 3 control functions that are not available with the DS1922L/DS1922T. Bit 1 must be set to 0. Under this condition the setting of bit 3 becomes a “don’t care.”

Mission Control

The DS1922L/DS1922T are set up for operation by writing appropriate data to the special function registers, which are located in the two register pages. The settings in the Mission Control register determine which format (8 or 16 bits) applies and whether old data can be overwritten by new data once the data-log memory is full. An additional control bit can be set to tell the DS1922L/DS1922T to wait with logging data until a temperature alarm is encountered.

Bit 5: Start Mission Upon Temperature Alarm (SUTA). This bit specifies whether a mission begins immediately (includes delayed start) or if a temperature alarm is required to start the mission. If this bit is 1, the device performs an 8-bit temperature conversion at the selected sample rate and begins with data logging only if an alarming temperature (high alarm or low alarm) was found. The first logged temperature is when the alarm occurred. However, the mission sample counter does not increment. This functionality is guaranteed by design and not production tested.

Bit 4: Rollover Control (RO). This bit controls whether, during a mission, the data-log memory is overwritten with new data or whether data logging is stopped once the data-log memory is full. Setting this bit to 1 enables the rollover and data logging continues at the beginning, overwriting previously collected data. If this bit is 0, the logging and conversions stop once the data-log memory is full. However, the RTC continues to run and the MIP bit remains set until the Stop Mission command is performed.

Bit 2: Temperature Logging Format Selection (TLFS). This bit specifies the format used to store temperature readings in the data-log memory. If this bit is 0, the data is stored in 8-bit format. If this bit is 1, the 16-bit format is used (higher resolution). With 16-bit format, the most significant byte is stored at the lower address.

Bit 0: Enable Temperature Logging (ETL). To set up the device for a temperature-logging mission, this bit must be set to logic 1. The recorded temperature values start at address 1000h.

Temperature Logger iButton with 8KB Data-Log Memory

DS1922L/DS1922T

Alarm Status Register Bitmap

ADDRESS	BIT 7	BIT 6	BIT 5	BIT 4	BIT 3	BIT 2	BIT 1	BIT 0
0214h	BOR	1	1	1	0	0	THF	TLF

Note: There is only read access to this register. Bits 4 to 6 have no function. They always read 1. Bits 2 and 3 have no function with the DS1922L/DS1922T. They always read 0. The alarm status bits are cleared simultaneously when the Clear Memory Function is invoked. See the Memory and Control Function Commands section for details.

General Status Register Bitmap

ADDRESS	BIT 7	BIT 6	BIT 5	BIT 4	BIT 3	BIT 2	BIT 1	BIT 0
0215h	1	1	0	WFTA	MEMCLR	0	MIP	0

Note: There is only read access to this register. Bits 0, 2, 5, 6, and 7 have no function.

Alarm Status

The fastest way to determine whether a programmed temperature threshold was exceeded during a mission is by reading the Alarm Status register. In a networked environment that contains multiple DS1922L/DS1922T iButtons, the devices that encountered an alarm can quickly be identified by means of the Conditional Search command (see the *1-Wire ROM Function Commands* section). The temperature alarm only occurs if enabled (see the *Temperature Sensor Alarm* section). The BOR alarm is always enabled.

Bit 7: Battery-On Reset Alarm (BOR). If this bit reads 1, the device has performed a power-on reset. This indicates that the device has experienced a shock big enough to interrupt the internal battery power supply. The device can still appear functional, but it has lost its factory calibration. Any data found in the data-log memory should be disregarded.

Bit 1: Temperature High Alarm Flag (THF). If this bit reads 1, there was at least one temperature conversion during a mission revealing a temperature equal to or higher than the value in the Temperature High Alarm register. A forced conversion can affect the THF bit. This bit can also be set with the initial alarm in the SUTA = 1 mode.

Bit 0: Temperature Low Alarm Flag (TLF). If this bit reads 1, there was at least one temperature conversion during a mission revealing a temperature equal to or lower than the value in the Temperature Low Alarm register. A forced conversion can affect the TLF bit. This bit can also be set with the initial alarm in the SUTA = 1 mode.

General Status

The information in the General Status register tells the host computer whether a mission-related command was executed successfully. Individual status bits indicate whether the DS1922L/DS1922T are performing a mission, waiting for a temperature alarm to trigger the logging of data, or whether the data from the latest mission has been cleared.

Bit 4: Waiting for Temperature Alarm (WFTA). If this bit reads 1, the Mission Start Upon Temperature Alarm was selected and the Start Mission command was successfully executed, but the device has not yet experienced the temperature alarm. This bit is cleared after a temperature alarm event, but is not affected by the Clear Memory command. Once set, WFTA remains set if a mission is stopped before a temperature alarm occurs. To clear WFTA manually before starting a new mission, set the high temperature alarm (address 0209h) to -40°C and perform a forced conversion.

Bit 3: Memory Cleared (MEMCLR). If this bit reads 1, the Mission Timestamp, Mission Samples Counter, and all the alarm flags of the Alarm Status register have been cleared in preparation of a new mission. Executing the Clear Memory command clears these memory sections. The MEMCLR bit returns to 0 as soon as a new mission is started by using the Start Mission command. The memory must be cleared for a mission to start.

Bit 1: Mission in Progress (MIP). If this bit reads 1, the device has been set up for a mission and this mission is still in progress. The MIP bit returns from logic 1 to logic 0 when a mission is ended. See the *Start Mission with Password* and *Stop Mission with Password* sections.

Temperature Logger *i*Button with 8KB Data-Log Memory

Mission Start Delay Counter Register Bitmap

ADDRESS	BIT 7	BIT 6	BIT 5	BIT 4	BIT 3	BIT 2	BIT 1	BIT 0
0216h	Delay Low Byte							
0217h	Delay Center Byte							
0218h	Delay High Byte							

Note: During a mission, there is only read access to this register.

Mission Timestamp Register Bitmap

ADDRESS	BIT 7	BIT 6	BIT 5	BIT 4	BIT 3	BIT 2	BIT 1	BIT 0
0219h	0	10 Seconds			Single Seconds			
021Ah	0	10 Minutes			Single Minutes			
021Bh	0	12/24	20 Hours AM/PM	10 Hours	Single Hours			
021Ch	0	0	10 Date		Single Date			
021Dh	CENT	0	0	10 Months	Single Months			
021Eh	10 Years				Single Years			

Note: There is only read access to this register.

Mission Samples Counter Register Bitmap

ADDRESS	BIT 7	BIT 6	BIT 5	BIT 4	BIT 3	BIT 2	BIT 1	BIT 0
0220h	Low Byte							
0221h	Center Byte							
0222h	High Byte							

Note: There is only read access to this register.

Mission Start Delay

The content of the Mission Start Delay Counter register tells how many minutes must expire from the time a mission was started until the first measurement of the mission takes place (SUTA = 0) or until the device starts testing the temperature for a temperature alarm (SUTA = 1). The Mission Start Delay is stored as an unsigned 24-bit integer number. The maximum delay is 16,777,215min, equivalent to 11,650 days or roughly 31 years. If the start delay is nonzero and the SUTA bit is set to 1, first the delay must expire before the device starts testing for temperature alarms to begin logging data.

For a typical mission, the Mission Start Delay is 0. If a mission is too long for a single DS1922L/DS1922T to store all readings at the selected sample rate, one can use several devices and set the Mission Start Delay for the second device to start recording as soon as the memory of the first device is full, and so on. The RO bit in the Mission Control register (address 0213h) must be set to 0 to prevent overwriting of collected data once the data-log memory is full.

Mission Timestamp

The Mission Timestamp register indicates the date and time of the first temperature sample of the mission. There is only read access to the Mission Timestamp register.

Mission Progress Indicator

Depending on settings in the Mission Control register (address 0213h), the DS1922L/DS1922T log temperature in 8-bit or 16-bit format. The Mission Samples Counter together with the starting address and the logging format (8 or 16 bits) provide the information to identify valid blocks of data that have been gathered during the current (MIP = 1) or latest mission (MIP = 0). See the *Data-Log Memory Usage* section for an illustration.

The number read from the Mission Samples Counter indicates how often the DS1922L/DS1922T woke up during a mission to measure temperature. The number format is 24-bit unsigned integer. The Mission Samples Counter is reset through the Clear Memory command.

Temperature Logger iButton with 8KB Data-Log Memory

Device Samples Counter Register Bitmap

ADDRESS	BIT 7	BIT 6	BIT 5	BIT 4	BIT 3	BIT 2	BIT 1	BIT 0
0223h	Low Byte							
0224h	Center Byte							
0225h	High Byte							

Note: There is only read access to this register.

Device Configuration Register Bitmap

ADDRESS	BIT 7	BIT 6	BIT 5	BIT 4	BIT 3	BIT 2	BIT 1	BIT 0	PART
0226h	0	0	0	0	0	0	0	0	DS2422
	0	0	1	0	0	0	0	0	DS1923
	0	1	0	0	0	0	0	0	DS1922L
	0	1	1	0	0	0	0	0	DS1922T
	1	0	0	0	0	0	0	0	DS1922E

Note: There is only read access to this register.

Password Control Register Bitmap

ADDRESS	BIT 7	BIT 6	BIT 5	BIT 4	BIT 3	BIT 2	BIT 1	BIT 0
0227h	EPW							

Note: During a mission, there is only read access to this register.

Other Indicators

The Device Samples Counter register is similar to the Mission Samples Counter register. During a mission this counter increments whenever the DS1922L/DS1922T wake up to measure and log data and when these devices are testing for a temperature alarm in SUTA mode. Between missions, the counter increments whenever the Forced Conversion command is executed. This way the Device Samples Counter register functions like a gas gauge for the battery that powers the iButton.

The Device Samples Counter register is reset to zero when the iButton is assembled. The number format is 24-bit unsigned integer. The maximum number that can be represented in this format is 16,777,215. Due to the calibration and tests at the factory, new devices can have a count value of up to 35,000. The typical value is well below 10,000.

The code in the Device Configuration register allows the master to distinguish between the DS2422 chip and different versions of the DS1922 iButtons. The *Device Configuration Register Bitmap* shows the codes assigned to the various devices.

Security by Password

The DS1922L/DS1922T are designed to use two passwords that control read access and full access. Reading from or writing to the scratchpad as well as the Forced Conversion command does not require a password. The password must be transmitted immediately after the command code of the memory or control function. If password checking is enabled, the password transmitted is compared to the passwords stored in the device. The data pattern stored in the Password Control register determines whether password checking is enabled.

To enable password checking, the EPW bits need to form a binary pattern of 10101010 (AAh). The default pattern of EPW is different from AAh. If the EPW pattern is different from AAh, any pattern is accepted as long as it has a length of exactly 64 bits. Once enabled, changing the passwords and disabling password checking requires the knowledge of the current full-access password.

Temperature Logger *i*Button with 8KB Data-Log Memory

Read Access Password Register Bitmap

ADDRESS	BIT 7	BIT 6	BIT 5	BIT 4	BIT 3	BIT 2	BIT 1	BIT 0
0228h	RP7	RP6	RP5	RP4	RP3	RP2	RP1	RP0
0229h	RP15	RP14	RP13	RP12	RP11	RP10	RP9	RP8
...	...							
022Eh	RP55	RP54	RP53	RP52	RP51	RP50	RP49	RP48
022Fh	RP63	RP62	RP61	RP60	RP59	RP58	RP57	RP56

Note: There is only write access to this register. Attempting to read the password reports all zeros. The password cannot be changed while a mission is in progress.

Full Access Password Register Bitmap

ADDRESS	BIT 7	BIT 6	BIT 5	BIT 4	BIT 3	BIT 2	BIT 1	BIT 0
0230h	FP7	FP6	FP5	FP4	FP3	FP2	FP1	FP0
0231h	FP15	FP14	FP13	FP12	FP11	FP10	FP9	FP8
...	...							
0236h	FP55	FP54	FP53	FP52	FP51	FP50	FP49	FP48
0237h	FP63	FP62	FP61	FP60	FP59	FP58	FP57	FP56

Note: There is only write access to this register. Attempting to read the password reports all zeros. The password cannot be changed while a mission is in progress.

Before enabling password checking, passwords for read-only access as well as for full access (read/write/control) must be written to the password registers. Setting up a password or enabling/disabling the password checking is done in the same way as writing data to a memory location; only the address is different. Since they are located in the same memory page, both passwords can be redefined at the same time.

The Read Access Password must be transmitted exactly in the sequence RP0, RP1...RP62, RP63. This password only applies to the Read Memory with CRC function. The DS1922L/DS1922T deliver the requested data only if the password transmitted by the master was correct or if password checking is not enabled.

The full-access password must be transmitted exactly in the sequence FP0, FP1...FP62, FP63. It affects the functions Read Memory with CRC, Copy Scratchpad, Clear Memory, Start Mission, and Stop Mission. The DS1922L/DS1922T execute the command only if the password transmitted by the master was correct or if password checking is not enabled.

Due to the special behavior of the write-access logic, the Password Control register and both passwords must be written at the same time. When setting up new passwords, always verify (read back) the scratchpad before sending the Copy Scratchpad command. After a new password is successfully copied from the scratchpad to its memory location, erase the scratchpad by filling it with new data (Write Scratchpad command). Otherwise, a copy of the passwords remains in the scratchpad for public read access.

Temperature Logger iButton with 8KB Data-Log Memory

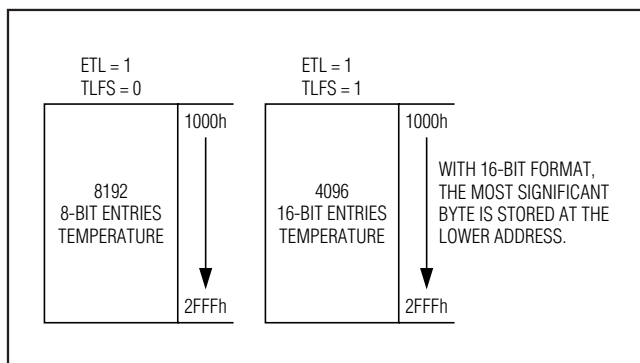

Figure 7. Temperature Logging

Data-Log Memory Usage

Once set up for a mission, the DS1922L/DS1922T log the temperature measurements at equidistant time points entry after entry in their data-log memory. The data-log memory can store 8192 entries in 8-bit format or 4096 entries in 16-bit format (Figure 7). In 16-bit format, the higher 8 bits of an entry are stored at the lower address. Knowing the starting time point (Mission Timestamp) and the interval between temperature measurements, one can reconstruct the time and date of each measurement.

There are two alternatives to the way the DS1922L/DS1922T behave after the data-log memory is filled with data. The user can program the device to either stop any further recording (disable rollover) or overwrite the previously recorded data (enable rollover), one entry at a time, starting again at the beginning of the respective memory section. The contents of the Mission Samples Counter in conjunction with the sample rate and the Mission Timestamp allow reconstructing the time points of all values stored in the data-log memory. This gives the exact history over time for the most recent measurements taken. Earlier measurements cannot be reconstructed.

Missioning

The typical task of the DS1922L/DS1922T iButtons is recording temperature. Before the devices can perform this function, they need to be set up properly. This procedure is called missioning.

First, the DS1922L/DS1922T must have their RTC set to a valid time and date. This reference time can be the local time, or, when used inside of a mobile unit, UTC (also called GMT, Greenwich Mean Time), or any other time standard that was agreed upon. The RTC oscillator must be running (EOSC = 1). The memory assigned to store the Mission Timestamp, Mission Samples

Counter, and alarm flags must be cleared using the Memory Clear command. To enable the device for a mission, the ETL bit must be set to 1. These are general settings that must be made in any case, regardless of the type of object to be monitored and the duration of the mission.

If alarm signaling is desired, the temperature alarm low and high thresholds must be defined. See the *Temperature Conversion* section for how to convert a temperature value into the binary code to be written to the threshold registers. In addition, the temperature alarm must be enabled for the low and/or high threshold. This makes the device respond to a Conditional Search command (see the *1-Wire ROM Function Commands* section), provided that an alarming condition has been encountered.

The setting of the RO bit (rollover enable) and sample rate depends on the duration of the mission and the monitoring requirements. If the most recently logged data is important, the rollover should be enabled (RO = 1). Otherwise, one should estimate the duration of the mission in minutes and divide the number by 8192 (8-bit format) or 4096 (16-bit format) to calculate the value of the sample rate (number of minutes between conversions). For example, if the estimated duration of a mission is 10 days (= 14400min), the 8192-byte capacity of the data-log memory would be sufficient to store a new 8-bit value every 1.8min (110s). If the DS1922L/DS1922T's data-log memories are not large enough to store all readings, one can use several devices and set the Mission Start Delay to values that make the second device start logging as soon as the memory of the first device is full, and so on. The RO bit must be set to 0 to disable rollover that would otherwise overwrite the logged data.

After the RO bit and the Mission Start Delay are set, the sample rate must be written to the Sample Rate register. The sample rate can be any value from 1 to 16,383, coded as an unsigned 14-bit binary number. The fastest sample rate is one sample per second (EHSS = 1, sample rate = 0001h) and the slowest is one sample every 273.05hr (EHSS = 0, sample rate = 3FFFh). To get one sample every 6min, for example, the sample rate value must be set to 6 (EHSS = 0) or 360 decimal (equivalent to 0168h at EHSS = 1).

If there is a risk of unauthorized access to the DS1922L/DS1922T or manipulation of data, one should define passwords for read access and full access. Before the passwords become effective, their use must be enabled. See the *Security by Password* section for more details.

Temperature Logger *i*Button with 8KB Data-Log Memory

The last step to begin a mission is to issue the Start Mission command. As soon as they have received this command, the DS1922L/DS1922T set the MIP flag and clear the MEMCLR flag. With the immediate/delayed start mode (SUTA = 0), and after as many minutes as specified by the Mission Start Delay are over, the device wakes up, copies the current date and time to the Mission Timestamp register, and logs the first entry of the mission. This increments both the Mission Samples Counter and Device Samples Counter. All subsequent log entries are made as specified by the value in the Sample Rate register and the EHSS bit.

If the start upon temperature alarm mode is chosen (SUTA = 1) and temperature logging is enabled (ETL = 1), the DS1922L/DS1922T first wait until the start delay is over. Then the device wakes up in intervals as specified by the sample rate and EHSS bit and measures the temperature. This increments the Device Samples Counter register only. The first sample of the mission is logged when the temperature alarm occurred. However, the Mission Samples Counter does not increment. One sample period later the Mission Timestamp register is set. From then on, both the Mission Samples Counter and Device Samples Counter registers increment at the same time. All subsequent log entries are made as specified by the value in the Sample Rate register and the EHSS bit.

The general-purpose memory operates independently of the other memory sections and is not write protected during a mission. All the DS1922L/DS1922T's memory

can be read at any time, e.g., to watch the progress of a mission. Attempts to read the passwords read 00h bytes instead of the data that is stored in the password registers.

Memory Access

Address Registers and Transfer Status

Because of the serial data transfer, the DS1922L/DS1922T employ three address registers called TA1, TA2, and E/S (Figure 8). Registers TA1 and TA2 must be loaded with the target address to which the data is written or from which data is sent to the master upon a Read command. Register E/S acts like a byte counter and Transfer Status register. It is used to verify data integrity with Write commands. Therefore, the master only has read access to this register. The lower 5 bits of the E/S register indicate the address of the last byte that has been written to the scratchpad. This address is called ending offset. **The DS1922L/DS1922T require that the ending offset is always 1Fh for a Copy Scratchpad command to function.** Bit 5 of the E/S register, called PF or partial byte flag, is set if the number of data bits sent by the master is not an integer multiple of 8. Bit 6 is always a 0. Note that the lowest 5 bits of the target address also determine the address within the scratchpad, where intermediate storage of data begins. This address is called byte offset. If the target address for a Write command is 13Ch, for example, the scratchpad stores incoming data beginning at the byte offset 1Ch and is full after only 4 bytes. The

BIT NUMBER	7	6	5	4	3	2	1	0
TARGET ADDRESS (TA1)	T7	T6	T5	T4	T3	T2	T1	T0
TARGET ADDRESS (TA2)	T15	T14	T13	T12	T11	T10	T9	T8
ENDING ADDRESS WITH DATA STATUS (E/S) (READ ONLY)	AA	0	PF	E4	E3	E2	E1	E0

Figure 8. Address Registers

Temperature Logger iButton with 8KB Data-Log Memory

corresponding ending offset in this example is 1Fh. For best economy of speed and efficiency, the target address for writing should point to the beginning of a page, i.e., the byte offset is 0. Thus, the full 32-byte capacity of the scratchpad is available, resulting also in the ending offset of 1Fh. The ending offset together with the PF flag are a means to support the master checking the data integrity after a Write command. The highest valued bit of the E/S register, called authorization accepted (AA), indicates that a valid Copy command for the scratchpad has been received and executed. Writing data to the scratchpad clears this flag.

Writing with Verification

To write data to the DS1922L/DS1922T, the scratchpad must be used as intermediate storage. First, the master issues the Write Scratchpad command to specify the desired target address, followed by the data to be written to the scratchpad. In the next step, the master sends the Read Scratchpad command to read the scratchpad and to verify data integrity. As preamble to the scratchpad data, the DS1922L/DS1922T send the requested target address TA1 and TA2 and the contents of the E/S register. If the PF flag is set, data did not arrive correctly in the scratchpad. The master does not need to continue reading; it can start a new trial to write data to the scratchpad. Similarly, a set AA flag indicates that the Write command was not recognized by the device. If everything went correctly, both flags are cleared and the ending offset indicates the address of the last byte written to the scratchpad. Now the master can continue verifying every data bit. After the master has verified the data, it must send the Copy Scratchpad command. This command must be followed exactly by the data of the three address registers TA1, TA2, and E/S, as the master has read them verifying the scratchpad. As soon as the DS1922L/DS1922T have received these bytes, they copy the data to the requested location beginning at the target address.

Memory and Control Function Commands

Figure 9 shows the protocols necessary for accessing the memory and the special function registers of the DS1922L/DS1922T. An example on how to use these and other functions to set up the DS1922L/DS1922T for a mission is included in the *Mission Example: Prepare and Start a New Mission* section. The communication between the master and the DS1922L/DS1922T takes place either at standard speed (default, OD = 0) or at overdrive speed (OD = 1). If not explicitly set into the overdrive mode the DS1922L/DS1922T assume standard speed. Internal memory access during a mission has priority over external access through the 1-Wire interface. This affects several commands in this section. See the *Memory Access Conflicts* section for details and solutions.

Write Scratchpad [0Fh]

After issuing the Write Scratchpad command, the master must first provide the 2-byte target address, followed by the data to be written to the scratchpad. The data is written to the scratchpad starting at the byte offset T[4:0]. The master must send as many bytes as are needed to reach the ending offset of 1Fh. If a data byte is incomplete, its content is ignored and the partial byte flag PF is set.

When executing the Write Scratchpad command, the CRC generator inside the DS1922L/DS1922T calculates a CRC of the entire data stream, starting at the command code and ending at the last data byte sent by the master (Figure 15). This CRC is generated using the CRC-16 polynomial by first clearing the CRC generator and then shifting in the command code (0Fh) of the Write Scratchpad command, the target addresses TA1 and TA2 as supplied by the master, and all the data bytes. If the ending offset is 11111b, the master can send 16 read time slots and receive the inverted CRC-16 generated by the DS1922L/DS1922T.

Note that both register pages are write protected during a mission. Although the Write Scratchpad command works normally at any time, the subsequent copy scratchpad to a register page fails during a mission.

Temperature Logger *i*Button with 8KB Data-Log Memory

Read Scratchpad [AAh]

This command is used to verify scratchpad data and target address. After issuing the Read Scratchpad command, the master begins reading. The first 2 bytes are the target address. The next byte is the ending offset/data status byte (E/S) followed by the scratchpad data beginning at the byte offset T[4:0], as shown in Figure 8. The master can continue reading data until the end of the scratchpad after which it receives an inverted CRC-16 of the command code, target addresses TA1 and TA2, the E/S byte, and the scratchpad data starting at the target address. After the CRC is read, the bus master reads logic 1s from the DS1922L/DS1922T until a reset pulse is issued.

Copy Scratchpad with Password [99h]

This command is used to copy data from the scratchpad to the writable memory sections. After issuing the Copy Scratchpad command, the master must provide a 3-byte authorization pattern, which can be obtained by reading the scratchpad for verification. This pattern must exactly match the data contained in the three address registers (TA1, TA2, E/S, in that order). Next, the master must transmit the 64-bit full-access password. If passwords are enabled and the transmitted password is different from the stored full-access password, the Copy Scratchpad with Password command fails. The device stops communicating and waits for a reset pulse. If the password was correct or if passwords were not enabled, the device tests the 3-byte authorization code. If the authorization code pattern matches, the AA flag is set and the copy begins. A pattern of alternating 1s and 0s is transmitted after the data has been copied until the master issues a reset pulse. While the copy is in progress, any attempt to reset the part is ignored. Copy typically takes 2 μ s per byte.

The data to be copied is determined by the three address registers. The scratchpad data from the beginning offset through the ending offset are copied, starting at the target address. The AA flag remains at logic 1 until it is cleared by the next Write Scratchpad command. With suitable password, the copy scratchpad always functions for the 16 pages of data memory and the 2 pages of calibration memory. While a mission is in

progress, write attempts to the register pages are not successful. The AA bit remaining at 0 indicates this.

Read Memory with Password and CRC [69h]

The Read Memory with CRC command is the general function to read from the device. This command generates and transmits a 16-bit CRC following the last data byte of a memory page.

After having sent the command code of the Read Memory with CRC command, the bus master sends a 2-byte address that indicates a starting byte location. Next, the master must transmit one of the 64-bit passwords. If passwords are enabled and the transmitted password does not match one of the stored passwords, the Read Memory with Password and CRC command fails. The device stops communicating and waits for a reset pulse. If the password was correct or if passwords were not enabled, the master reads data from the DS1922L/DS1922T beginning from the starting address and continuing until the end of a 32-byte page is reached. At that point the bus master sends 16 additional read-data time slots and receives the inverted 16-bit CRC. With subsequent read-data time slots the master receives data starting at the beginning of the next memory page followed again by the CRC for that page. This sequence continues until the bus master resets the device. When trying to read the passwords or memory areas that are marked as “reserved,” the DS1922L/DS1922T transmit 00h or FFh bytes, respectively. The CRC at the end of a 32-byte memory page is based on the data as it was transmitted.

With the initial pass through the read memory with CRC flow, the 16-bit CRC value is the result of shifting the command byte into the cleared CRC generator followed by the two address bytes and the contents of the data memory. Subsequent passes through the read memory with CRC flow generate a 16-bit CRC that is the result of clearing the CRC generator and then shifting in the contents of the data memory page. After the 16-bit CRC of the last page is read, the bus master receives logic 1s from the DS1922L/DS1922T until a reset pulse is issued. The Read Memory with CRC command sequence can be ended at any point by issuing a reset pulse.

Temperature Logger iButton with 8KB Data-Log Memory

DS1922L/DS1922T

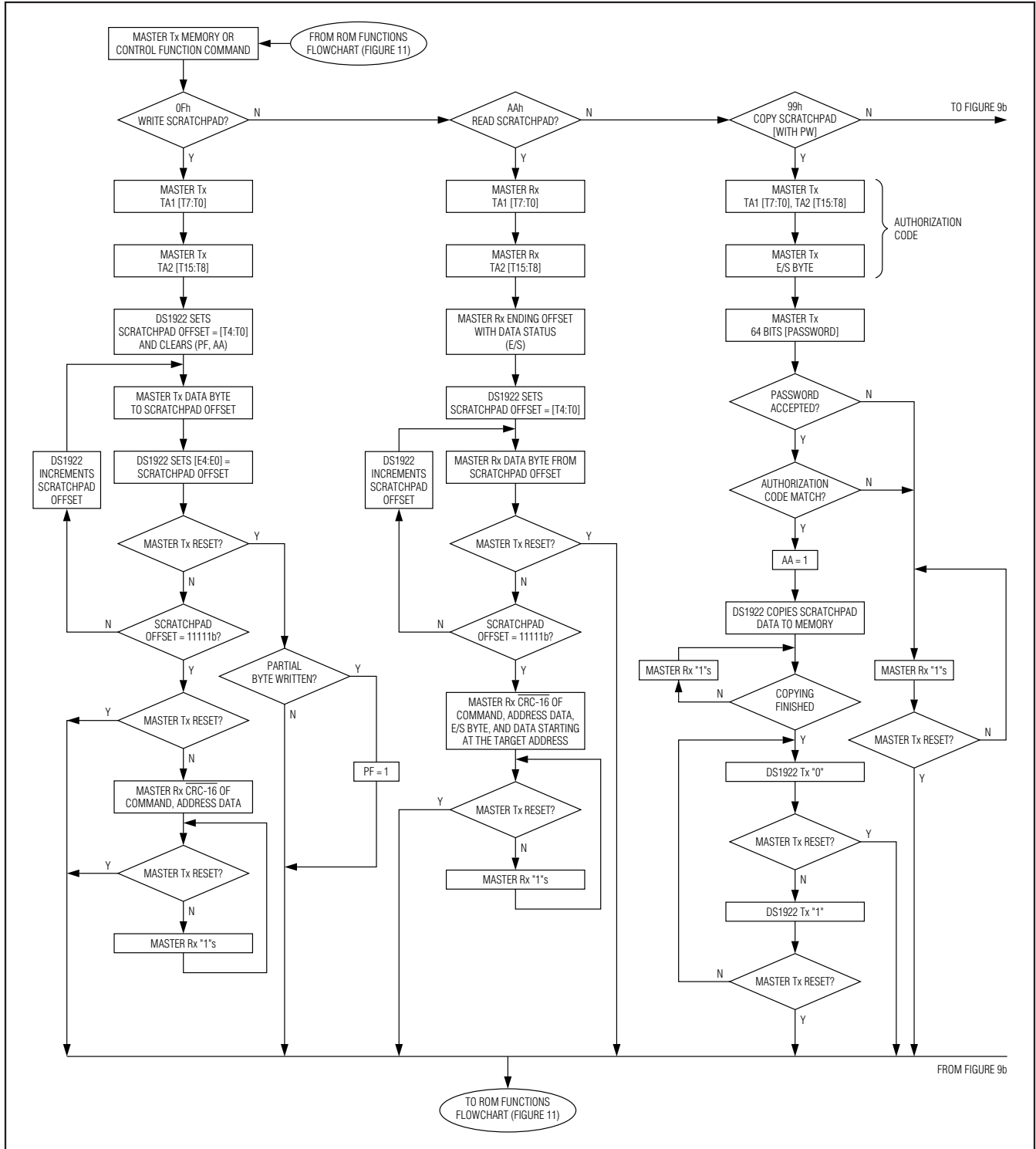

Figure 9a. Memory/Control Function Flowchart

Temperature Logger *i*Button with 8KB Data-Log Memory

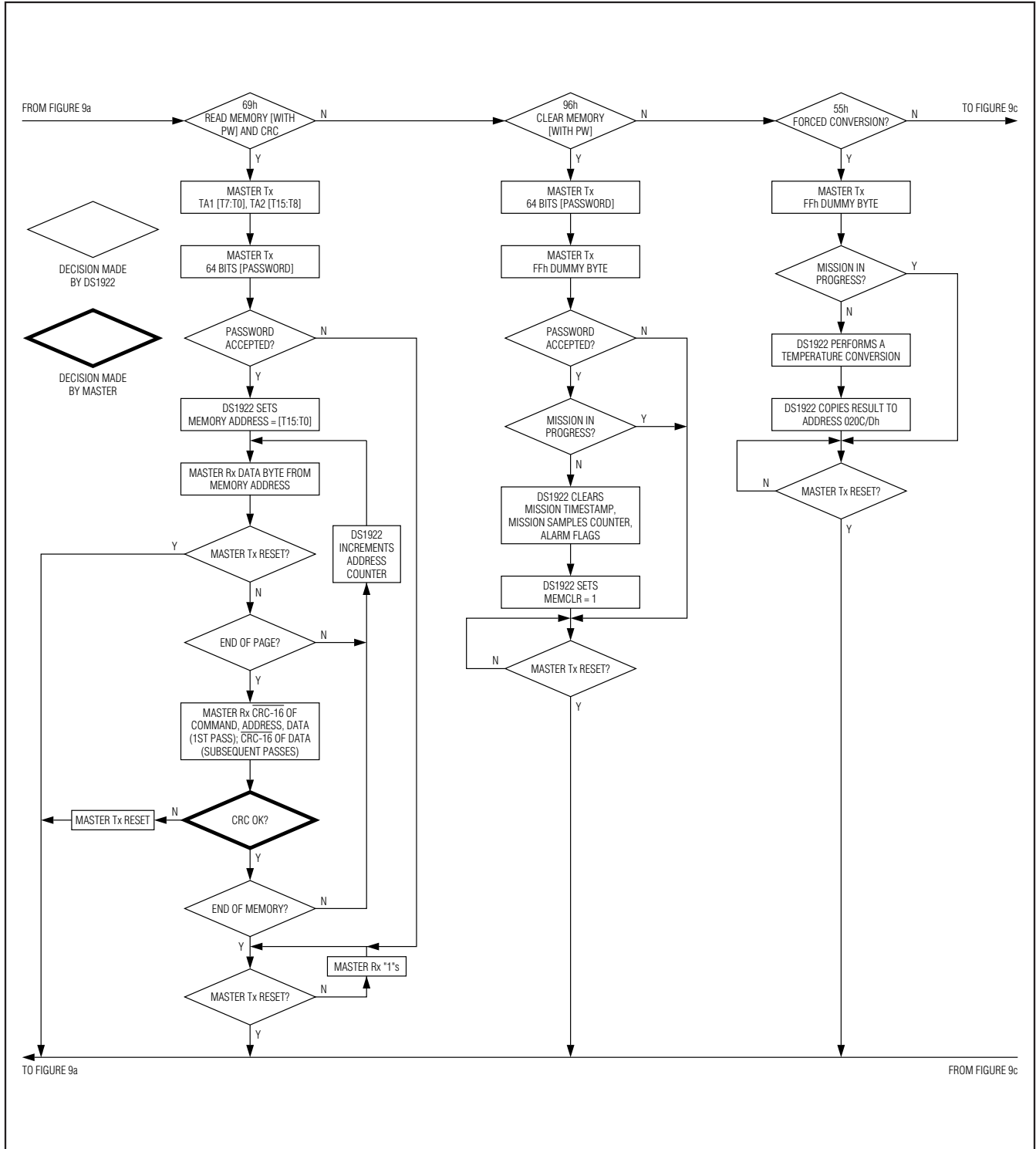

Figure 9b. Memory/Control Function Flowchart (continued)

Temperature Logger iButton with 8KB Data-Log Memory

DS1922L/DS1922T

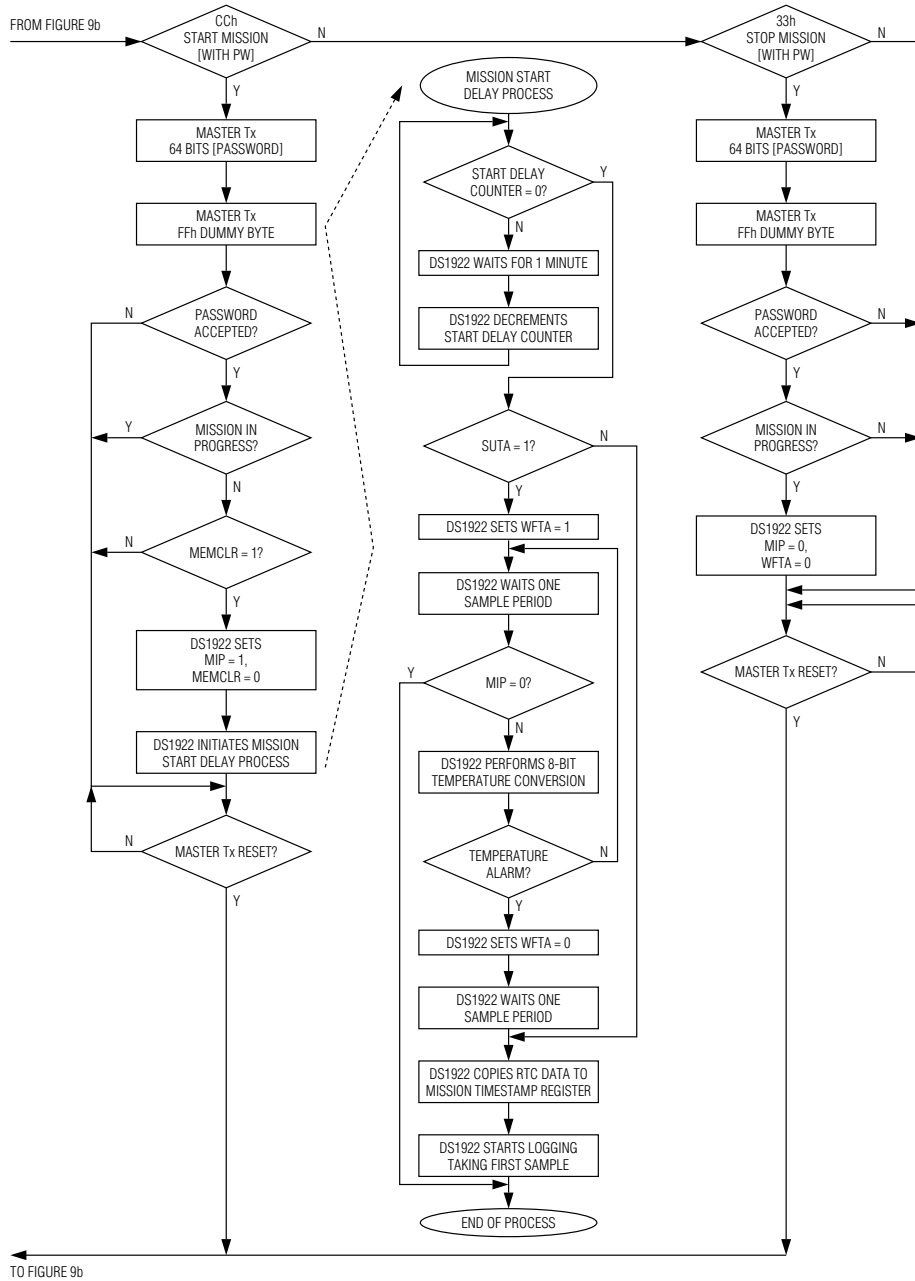

Figure 9c. Memory/Control Function Flowchart (continued)

Temperature Logger *i*Button with 8KB Data-Log Memory

Clear Memory with Password [96h]

The Clear Memory with Password command is used to prepare the device for another mission. This command is only executed if no mission is in progress. After the command code the master must transmit the 64-bit full-access password followed by an FFh dummy byte. If passwords are enabled and the transmitted password is different from the stored full-access password or a mission is in progress, the Clear Memory with Password command fails. The device stops communicating and waits for a reset pulse. If the password was correct or if passwords were not enabled, the device clears the Mission Timestamp register, Mission Samples Counter register, and all alarm flags of the Alarm Status register. After these cells are cleared, the MEMCLR bit of the General Status register reads 1 to indicate the successful execution of the Clear Memory with Password command. Clearing of the data-log memory is not necessary because the Mission Samples Counter indicates how many entries in the data-log memory are valid.

Forced Conversion [55h]

The Forced Conversion command can be used to measure the temperature without starting a mission. After the command code, the master must send one FFh byte to get the conversion started. The conversion result is found as a 16-bit value in the Latest Temperature Conversion Result register. This command is only executed if no mission is in progress (MIP = 0). It cannot be interrupted and takes maximum 600ms to complete. During this time memory access through the 1-Wire interface is blocked. The device behaves the same way as during a mission when the sampling interferes with a memory/control function command. See the *Memory Access Conflicts* section for details.

Start Mission with Password [CCh]

The DS1922L/DS1922T use a control function command to start a mission. A new mission can only be started if the previous mission has been ended and the memory has been cleared. After the command code, the master must transmit the 64-bit full-access password followed by an FFh dummy byte. If passwords are enabled and the transmitted password is different from the stored full-access password or a mission is in progress, the Start Mission with Password command fails. The device stops communicating and waits for a reset pulse. If the password was correct or if passwords were not enabled, the device starts a mission. If SUTA = 0, the sampling begins as soon as the Mission Start Delay is over. If SUTA = 1, the first sample is written to the data-log memory at the time the temperature alarm occurred. However, the Mission Samples Counter does **not** increment. One sample period later, the Mission Timestamp register is set and the regular sampling and logging begins. While the device is waiting for a temperature alarm to occur, the WFTA flag in the General Status register reads 1. During a mission there is only read access to the register pages.

Stop Mission with Password [33h]

The DS1922L/DS1922T use a control function command to stop a mission. Only a mission that is in progress can be stopped. After the command code, the master must transmit the 64-bit full-access password followed by a FFh dummy byte. If passwords are enabled and the transmitted password is different from the stored full-access password or a mission is not in progress, the Stop Mission with Password command fails. The device stops communicating and waits for a reset pulse. If the password was correct or if passwords were not enabled, the device clears the MIP bit in the General Status register and restores write access to the register pages. The WFTA bit is not cleared. See the description of the General Status register for a method to clear the WFTA bit.

Temperature Logger *i*Button with 8KB Data-Log Memory

DS1922L/DS1922T

Memory Access Conflicts

While a mission is in progress or while the device is waiting for a temperature alarm to start a mission, periodically a temperature sample is taken and logged. This “internal activity” has priority over 1-Wire communication. As a consequence, device-specific commands (excluding ROM function commands and 1-Wire reset) do not perform properly when internal and “external” activities interfere with each other. Not affected are the Start Mission, Forced Conversion, and Clear Memory commands, because they are not applicable while a

mission is in progress or while the device is waiting for a temperature alarm. Table 3 explains how the remaining five commands are affected by internal activity, how to detect this interference, and how to work around it.

The interference is more likely to be seen with a high-sample rate (one sample every second) and with high-resolution logging, which can last up to 600ms. With lower sample rates, interference may hardly be visible at all. In any case, when writing driver software it is important to know about the possibility of interference and to take measures to work around it.

Table 3. Memory Access Conflicts and Solutions

COMMAND	INDICATION OF INTERFERENCE	SOLUTION
Write Scratchpad	The CRC-16 at the end of the command flow reads FFFFh.	Wait 0.5s, 1-Wire reset, address the device, repeat Write Scratchpad with the same data, and check the validity of the CRC-16 at the end of the command flow. Alternatively, use Read Scratchpad to verify data integrity.
Read Scratchpad	The data read changes to FFh bytes or all bytes received are FFh, including the CRC at the end of the command flow.	Wait 0.5s, 1-Wire reset, address the device, repeat Read Scratchpad, and check the validity of the CRC-16 at the end of the command flow.
Copy Scratchpad	The device behaves as if the authorization code or password was not valid or as if the copy function would not end.	Wait 0.5s, 1-Wire reset, address the device, issue Read Scratchpad, and check the AA bit of the E/S byte. If the AA bit is set, Copy Scratchpad was successful.
Read Memory with CRC	The data read changes to all FFh bytes or all bytes received are FFh, including the CRC at the end of the command flow, despite a valid password.	Wait 0.5s, 1-Wire reset, address the device, repeat Read Memory with CRC, and check the validity of the CRC-16 at the end of the memory page.
Stop Mission	The General Status register at address 0215h reads FFh or the MIP bit is 1 while bits 0, 2, and 5 are 0.	Wait 0.5s, 1-Wire reset, address the device, and repeat Stop Mission. Perform a 1-Wire reset, address the device, read the General Status register at address 0215h, and check the MIP bit. If the MIP bit is 0, Stop Mission was successful.

Temperature Logger *i*Button with 8KB Data-Log Memory

1-Wire Bus System

The 1-Wire bus is a system that has a single bus master and one or more slaves. In all instances the DS1922L/DS1922T are slave devices. The bus master is typically a microcontroller. The discussion of this bus system is broken down into three topics: hardware configuration, transaction sequence, and 1-Wire signaling (signal types and timing). The 1-Wire protocol defines bus transactions in terms of the bus state during specific time slots that are initiated on the falling edge of sync pulses from the bus master.

Hardware Configuration

The 1-Wire bus has only a single line by definition; it is important that each device on the bus be able to drive it at the appropriate time. To facilitate this, each device attached to the 1-Wire bus must have open-drain or three-state outputs. The 1-Wire port of the DS1922L/DS1922T is open drain with an internal circuit equivalent to that shown in Figure 10.

A multidrop bus consists of a 1-Wire bus with multiple slaves attached. At standard speed the 1-Wire bus has a maximum data rate of 16.3kbps. The speed can be boosted to 142kbps by activating the overdrive mode. The DS1922L/DS1922T are not guaranteed to be fully compliant to the *i*Button standard. Their maximum data rate in standard speed is 15.4kbps and 125kbps in overdrive speed. The value of the pullup

resistor primarily depends on the network size and load conditions. The DS1922L/DS1922T require a pullup resistor of maximum 2.2kΩ at any speed.

The idle state for the 1-Wire bus is high. If for any reason a transaction needs to be suspended, the bus **must** be left in the idle state if the transaction is to resume. If this does not occur and the bus is left low for more than 16μs (overdrive speed) or more than 120μs (standard speed), one or more devices on the bus may be reset. Note that the DS1922L/DS1922T do not quite meet the full 16μs maximum low time of the normal 1-Wire bus overdrive timing. With the DS1922L/DS1922T, the bus must be left low for no longer than 12μs at overdrive to ensure that no DS1922L/DS1922T on the 1-Wire bus performs a reset. The DS1922L/DS1922T communicate properly when used in conjunction with a DS2480B or DS2490 1-Wire driver and adapters that are based on these driver chips.

Transaction Sequence

The protocol for accessing the DS1922L/DS1922T through the 1-Wire port is as follows:

- Initialization
- ROM Function Command
- Memory/Control Function Command
- Transaction/Data

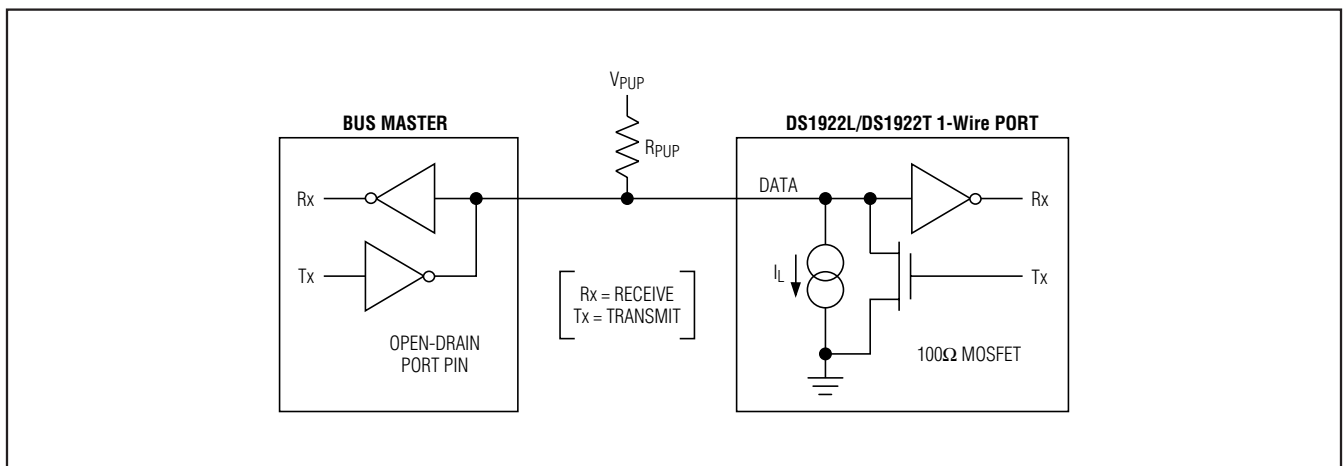

Figure 10. Hardware Configuration

Temperature Logger *i*Button with 8KB Data-Log Memory

Initialization

All transactions on the 1-Wire bus begin with an initialization sequence. The initialization sequence consists of a reset pulse transmitted by the bus master followed by presence pulse(s) transmitted by the slave(s). The presence pulse lets the bus master know that the DS1922L/DS1922T are on the bus and are ready to operate. For more details, see the *1-Wire Signaling* section.

1-Wire ROM Function Commands

Once the bus master has detected a presence, it can issue one of the eight ROM function commands that DS1922L/DS1922T support. All ROM function commands are 8 bits long. A list of these commands follows (see the flowchart in Figure 11).

Read ROM [33h]

This command allows the bus master to read the DS1922L/DS1922T's 8-bit family code, unique 48-bit serial number, and 8-bit CRC. This command can only be used if there is a single slave on the bus. If more than one slave is present on the bus, a data collision occurs when all slaves try to transmit at the same time (open drain produces a wired-AND result). The resultant family code and 48-bit serial number results in a mismatch of the CRC.

Match ROM [55h]

The Match ROM command, followed by a 64-bit ROM sequence, allows the bus master to address a specific DS1922L/DS1922T on a multidrop bus. Only the DS1922L/DS1922T that exactly matches the 64-bit ROM sequence responds to the following memory function command. All other slaves wait for a reset pulse. This command can be used with a single device or multiple devices on the bus.

Search ROM [F0h]

When a system is initially brought up, the bus master might not know the number of devices on the 1-Wire bus or their registration numbers. By taking advantage of the wired-AND property of the bus, the master can

use a process of elimination to identify the registration numbers of all slave devices. For each bit of the registration number, starting with the least significant bit, the bus master issues a triplet of time slots. On the first slot, each slave device participating in the search outputs the true value of its registration number bit. On the second slot, each slave device participating in the search outputs the complemented value of its registration number bit. On the third slot, the master writes the true value of the bit to be selected. All slave devices that do not match the bit written by the master stop participating in the search. If both of the read bits are zero, the master knows that slave devices exist with both states of the bit. By choosing which state to write, the bus master branches in the ROM code tree. After one complete pass, the bus master knows the registration number of a single device. Additional passes identify the registration numbers of the remaining devices. Refer to Application Note 187: *1-Wire Search Algorithm* for a detailed discussion, including an example.

Conditional Search ROM [ECh]

The Conditional Search ROM command operates similarly to the Search ROM command except that only those devices that fulfill certain conditions participate in the search. This function provides an efficient means for the bus master to identify devices on a multidrop system that have to signal an important event. After each pass of the conditional search that successfully determined the 64-bit ROM code for a specific device on the multidrop bus, that particular device can be individually accessed as if a Match ROM had been issued, since all other devices have dropped out of the search process and are waiting for a reset pulse.

The DS1922L/DS1922T respond to the conditional search ROM command if one of the three alarm flags of the Alarm Status register (address 0214h) reads 1. The temperature alarm only occurs if enabled (see the *Temperature Sensor Alarm* section). The BOR alarm is always enabled. The first alarm that occurs makes the device respond to the Conditional Search ROM command.

Temperature Logger *i*Button with 8KB Data-Log Memory

Skip ROM [CCh]

This command can save time in a single-drop bus system by allowing the bus master to access the memory functions without providing the 64-bit ROM code. For example, if more than one slave is present on the bus and a read command is issued following the Skip ROM command, data collision occurs on the bus as multiple slaves transmit simultaneously (open-drain pulldowns produce a wired-AND result).

Resume [A5h]

The DS1922L/DS1922T must be accessed several times before a mission starts. In a multidrop environment this means that the 64-bit ROM code after a Match ROM command must be repeated for every access. To maximize the data throughput in a multidrop environment, the Resume command was implemented. This command checks the status of the RC bit and, if it is set, directly transfers control to the memory/control functions, similar to a Skip ROM command. The only way to set the RC bit is through successfully executing the Match ROM, Search ROM, or Overdrive-Match ROM command. Once the RC bit is set, the device can repeatedly be accessed through the Resume command function. Accessing another device on the bus clears the RC bit, preventing two or more devices from simultaneously responding to the Resume command.

Overdrive-Skip ROM [3Ch]

On a single-drop bus this command can save time by allowing the bus master to access the memory/control functions without providing the 64-bit ROM code. Unlike the normal Skip ROM command, the Overdrive-Skip

ROM command sets the DS1922L/DS1922T in the overdrive mode (OD = 1). All communication following this command must occur at overdrive speed until a reset pulse of minimum 690 μ s duration resets all devices on the bus to standard speed (OD = 0).

When issued on a multidrop bus, this command sets all overdrive-supporting devices into overdrive mode. To subsequently address a specific overdrive-supporting device, a reset pulse at overdrive speed must be issued followed by a Match ROM or Search ROM command sequence. This speeds up the time for the search process. If more than one slave supporting overdrive is present on the bus and the Overdrive-Skip ROM command is followed by a read command, data collision occurs on the bus as multiple slaves transmit simultaneously (open-drain pulldowns produce a wired-AND result).

Overdrive-Match ROM [69h]

The Overdrive-Match ROM command followed by a 64-bit ROM sequence transmitted at overdrive speed allows the bus master to address a specific DS1922L/DS1922T on a multidrop bus and to simultaneously set it in overdrive mode. Only the DS1922L/DS1922T that exactly matches the 64-bit ROM sequence respond to the subsequent memory/control function command. Slaves already in overdrive mode from a previous Overdrive-Skip ROM or successful Overdrive-Match ROM command remain in overdrive mode. All overdrive-capable slaves return to standard speed at the next reset pulse of minimum 690 μ s duration. The Overdrive-Match ROM command can be used with a single or multiple devices on the bus.

Temperature Logger *i*Button with 8KB Data-Log Memory

DS1922L/DS1922T

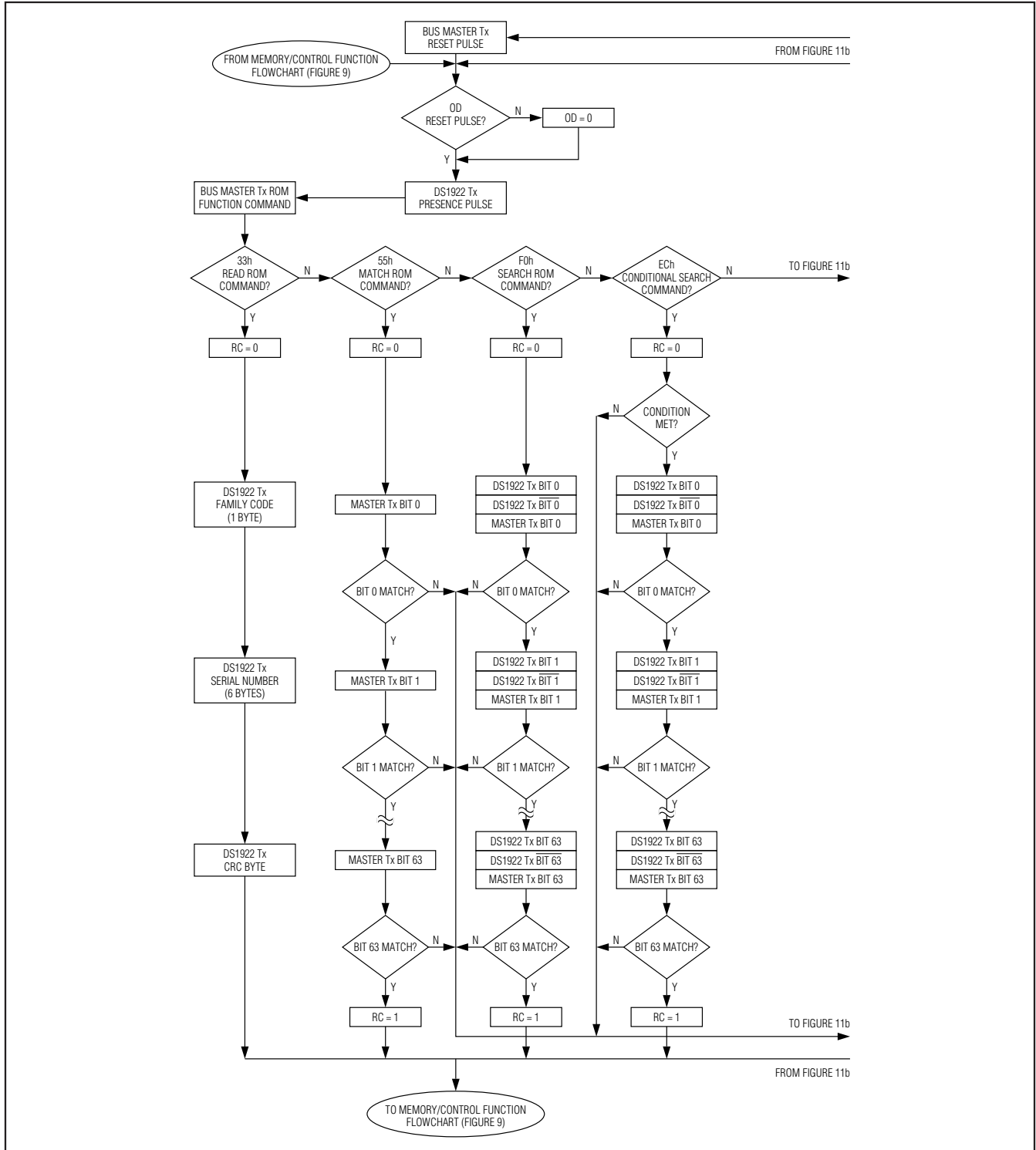
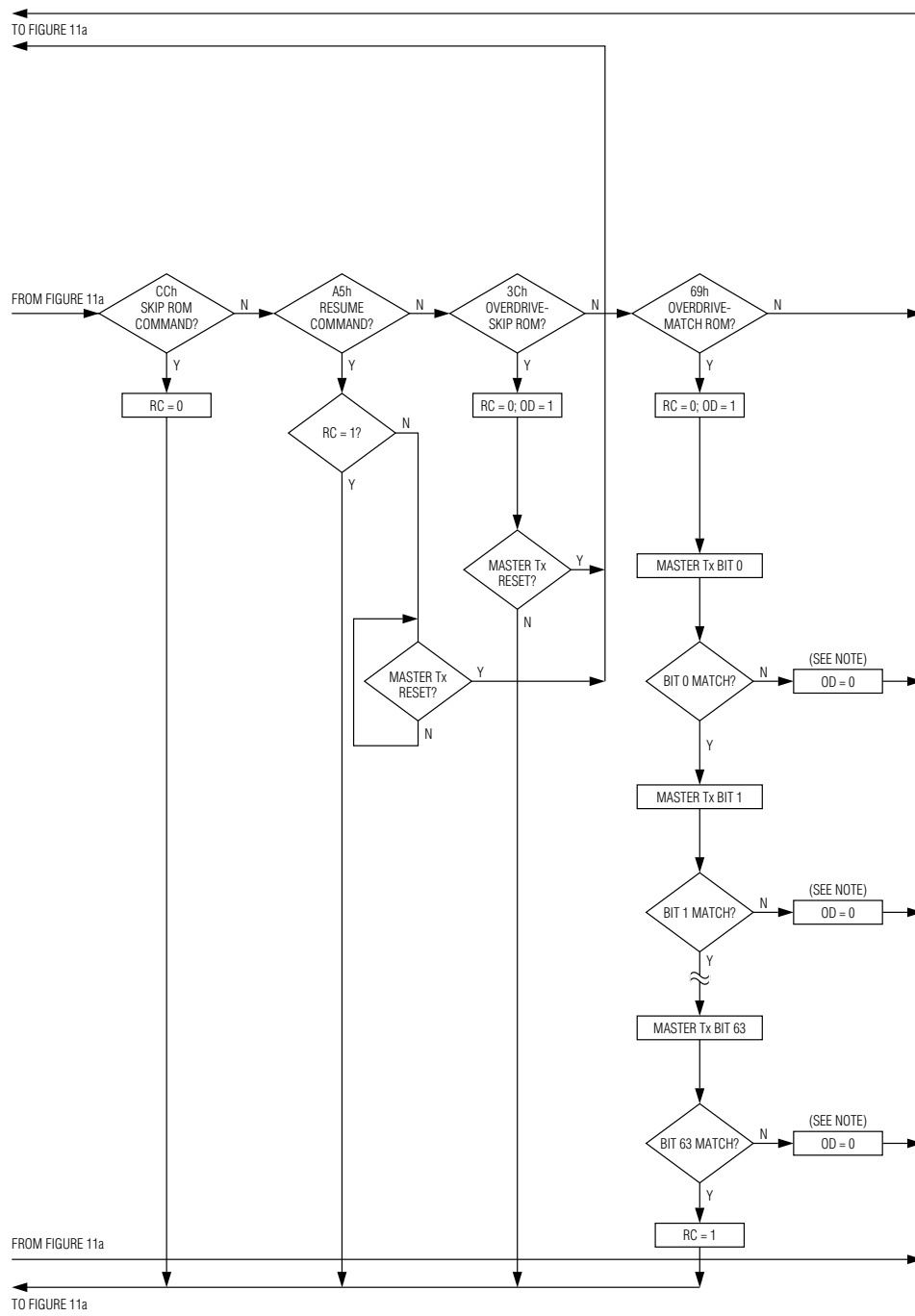

Figure 11a. ROM Functions Flowchart

Temperature Logger *i*Button with 8KB Data-Log Memory



NOTE: THE OD FLAG REMAINS AT 1 IF THE DEVICE WAS ALREADY AT OVERDRIVE SPEED BEFORE THE OVERDRIVE-MATCH ROM COMMAND WAS ISSUED.

Figure 11b. ROM Functions Flowchart (continued)

Temperature Logger *i*Button with 8KB Data-Log Memory

DS1922L/DS1922T

1-Wire Signaling

The DS1922L/DS1922T require strict protocols to ensure data integrity. The protocol consists of four types of signaling on one line: reset pulse with reset pulse and presence pulse, write-zero, write-one, and read-data. Except for the presence pulse, the bus master initiates all these signals. The DS1922L/DS1922T can communicate at two different speeds: standard speed and overdrive speed. If not explicitly set into the overdrive mode, the DS1922L/DS1922T communicate at standard speed. While in overdrive mode the fast timing applies to all waveforms.

To get from idle to active, the voltage on the 1-Wire line needs to fall from V_{PUP} below the threshold V_{TL} . To get from active to idle, the voltage needs to rise from V_{ILMAX} past the threshold V_{TH} . The time it takes for the voltage to make this rise is seen in Figure 12 as “ ϵ ” and its duration depends on the pullup resistor (R_{PUP}) used and the capacitance of the 1-Wire network attached. The voltage V_{ILMAX} is relevant for the DS1922L/DS1922T when determining a logical level, not triggering any events.

The initialization sequence required to begin any communication with the DS1922L/DS1922T is shown in Figure 12. A reset pulse followed by a presence pulse indicates the DS1922L/DS1922T are ready to receive data, given the correct ROM and memory function command. If the bus master uses slew-rate control on the falling edge, it must pull down the line for $t_{RSTL} + t_F$ to compensate for the edge. A t_{RSTL} duration of 690 μ s or longer exits the overdrive mode, returning the device to standard speed. If the DS1922L/DS1922T are in over-

drive mode and t_{RSTL} is no longer than 80 μ s, the device remains in overdrive mode.

After the bus master has released the line, it goes into receive mode (Rx). Now the 1-Wire bus is pulled to V_{PUP} through the pullup resistor or, in the case of a DS2480B driver, through active circuitry. When the threshold V_{TH} is crossed, the DS1922L/DS1922T wait for t_{PDH} and then transmit a presence pulse by pulling the line low for t_{PDL} . To detect a presence pulse, the master must test the logical state of the 1-Wire line at t_{MSP} .

The t_{RSTH} window must be at least the sum of t_{PDHMAX} , t_{PDLMAX} , and t_{RECMIN} . Immediately after t_{RSTH} is expired, the DS1922L/DS1922T are ready for data communication. In a mixed population network, t_{RSTH} should be extended to minimum 480 μ s at standard speed and 48 μ s at overdrive speed to accommodate other 1-Wire devices.

Read/Write Time Slots

Data communication with the DS1922L/DS1922T takes place in time slots that carry a single bit each. Write time slots transport data from bus master to slave. Read time slots transfer data from slave to master. The definitions of the write and read time slots are illustrated in Figure 13.

All communication begins with the master pulling the data line low. As the voltage on the 1-Wire line falls below the threshold V_{TL} , the DS1922L/DS1922T start their internal timing generator that determines when the data line is sampled during a write time slot and how long data is valid during a read time slot.

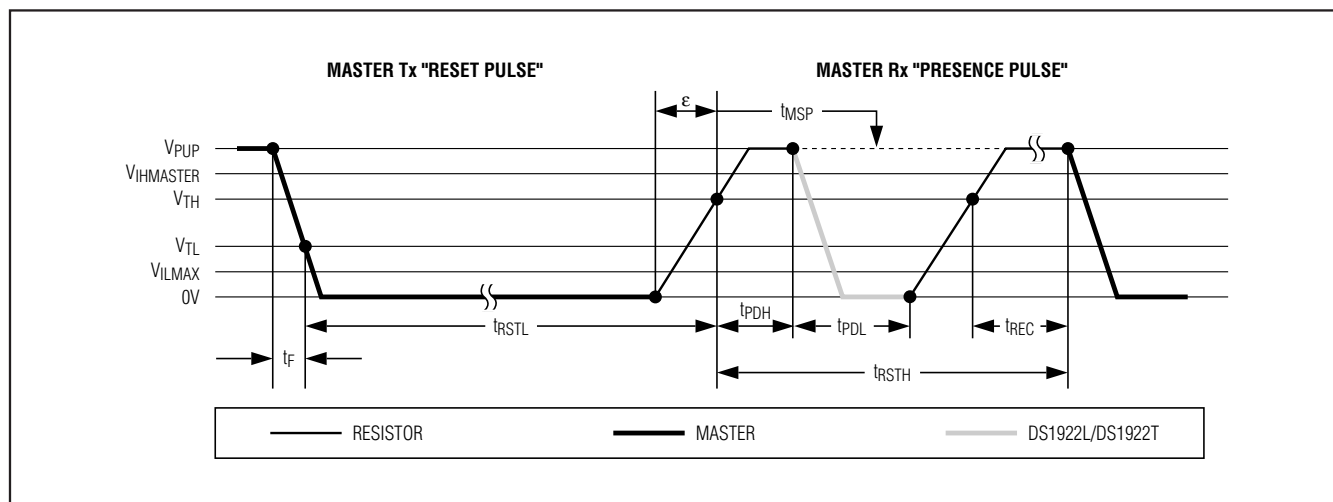

Figure 12. Initialization Procedure: Reset and Presence Pulse

Temperature Logger *i*Button with 8KB Data-Log Memory

Master-to-Slave

For a **write-one** time slot, the voltage on the data line must have crossed the V_{TH} threshold before the write-one low time t_{W1LMAX} is expired. For a **write-zero** time slot, the voltage on the data line must stay below the V_{TH} threshold until the write-zero low time t_{W0LMIN} is expired. The voltage on the data line should not exceed V_{ILMAX} during the entire t_{W0L} or t_{W1L} window. After the V_{TH} threshold has been crossed, the DS1922L/DS1922T need a recovery time t_{REC} before they are ready for the next time slot.

Slave-to-Master

A **read-data** time slot begins like a write-one time slot. The voltage on the data line must remain below V_{TL} until the read low time t_{RL} is expired. During the t_{RL} window, when responding with a 0, the DS1922L/DS1922T start pulling the data line low; their internal timing generator determines when this pulldown ends and the voltage starts rising again. When responding with a 1, the DS1922L/DS1922T do not hold the data line low at all, and the voltage starts rising as soon as t_{RL} is over.

The sum of $t_{RL} + \delta$ (rise time) on one side and the internal timing generator of the DS1922L/DS1922T on the other side define the master sampling window (t_{MSRMIN} to t_{MSRMAX}) in which the master must perform a read from the data line. For most reliable communication, t_{RL} should be as short as permissible and the master should read close to but no later than t_{MSRMAX} . After reading from the data line, the master must wait until t_{SLOT} is expired. This guarantees sufficient recovery time t_{REC} for the DS1922L/DS1922T to get ready for the next time slot.

Improved Network Behavior (Switchpoint Hysteresis)

In a 1-Wire environment line termination is possible only during transients controlled by the bus master (1-Wire driver). 1-Wire networks, therefore, are susceptible to noise of various origins. Depending on the physical size and topology of the network, reflections from end points and branch points can add up or cancel each other to some extent. Such reflections are visible as glitches or ringing on the 1-Wire communication

line. Noise coupled onto the 1-Wire line from external sources can also result in signal glitching. A glitch during the rising edge of a time slot can cause a slave device to lose synchronization with the master and, as a consequence, result in a search ROM command coming to a dead end or cause a device-specific function command to abort. For better performance in network applications, the DS1922L/DS1922T use a new 1-Wire front-end, which makes them less sensitive to noise and also reduces the magnitude of noise injected by the slave device itself.

The DS1922L/DS1922T's 1-Wire front-end differs from traditional slave devices in four characteristics:

- 1) The falling edge of the presence pulse has a controlled slew rate. This provides a better match to the line impedance than a digitally switched transistor, converting the high-frequency ringing known from traditional devices into a smoother low-bandwidth transition. The slew-rate control is specified by the parameter t_{FPD} , which has different values for standard and overdrive speed.
- 2) There is additional lowpass filtering in the circuit that detects the falling edge at the beginning of a time slot. This reduces the sensitivity to high-frequency noise. This additional filtering does not apply at overdrive speed.
- 3) There is a hysteresis at the low-to-high switching threshold V_{TH} . If a negative glitch crosses V_{TH} but does not go below $V_{TH} - V_{HY}$, it is not recognized (Figure 14, Case A). The hysteresis is effective at any 1-Wire speed.
- 4) There is a time window specified by the rising edge hold-off time t_{REH} during which glitches are ignored, even if they extend below $V_{TH} - V_{HY}$ threshold (Figure 14, Case B, $t_{GL} < t_{REH}$). Deep voltage droops or glitches that appear late after crossing the V_{TH} threshold and extend beyond the t_{REH} window cannot be filtered out and are taken as the beginning of a new time slot (Figure 14, Case C, $t_{GL} \geq t_{REH}$).

Devices that have the parameters t_{FPD} , V_{HY} , and t_{REH} specified in their electrical characteristics use the improved 1-Wire front-end.

Temperature Logger *i*Button with 8KB Data-Log Memory

DS1922L/DS1922T

WRITE-ONE TIME SLOT

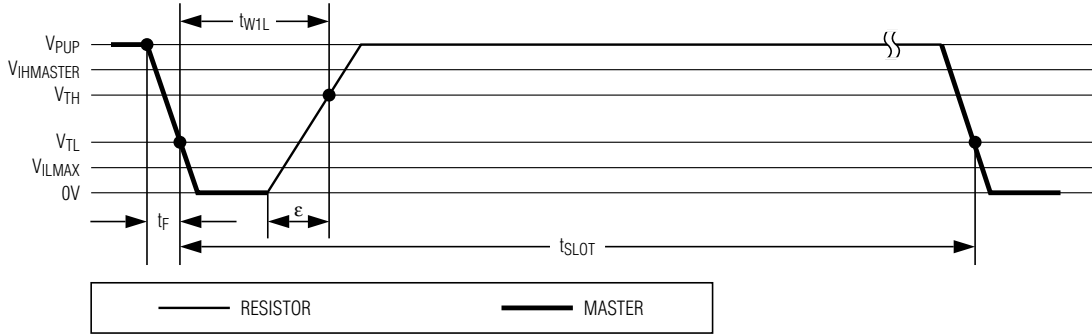

WRITE-ZERO TIME SLOT

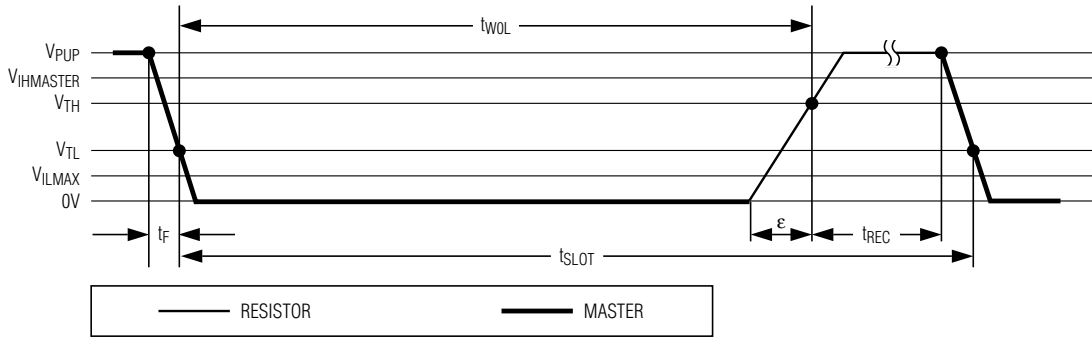

READ-DATA TIME SLOT

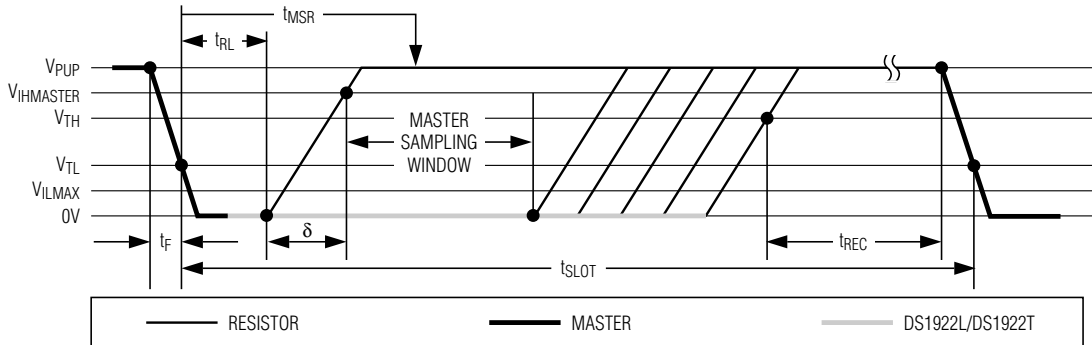

Figure 13. Read/Write Timing Diagrams

Temperature Logger *i*Button with 8KB Data-Log Memory

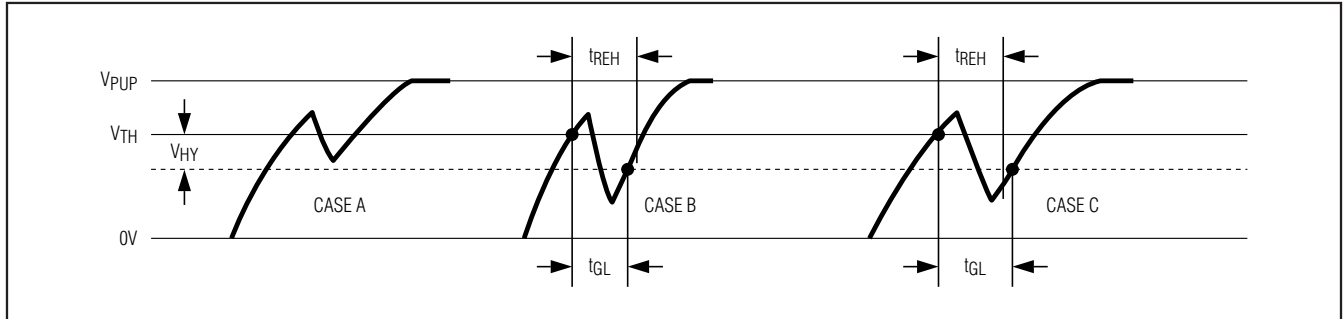

Figure 14. Noise Suppression Scheme

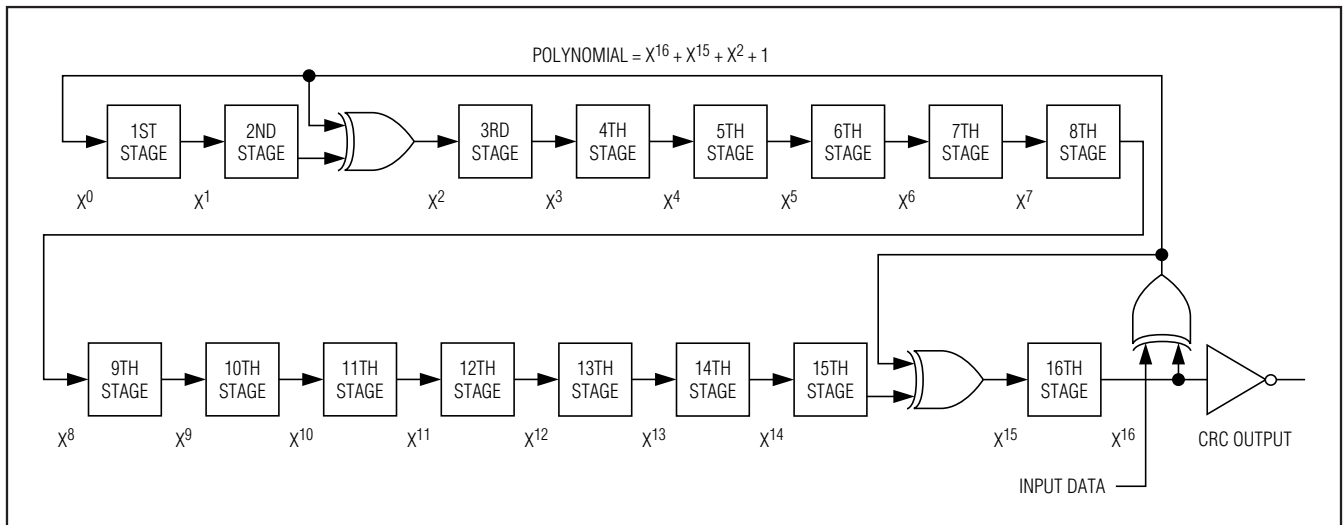

Figure 15. CRC-16 Hardware Description and Polynomial

CRC Generation

The DS1922L/DS1922T use two types of CRCs. One CRC is an 8-bit type and is stored in the most significant byte of the 64-bit ROM. The bus master can compute a CRC value from the first 56 bits of the 64-bit ROM and compare it to the value stored within the DS1922L/DS1922T to determine if the ROM data has been received error-free. The equivalent polynomial function of this CRC is $X^8 + X^5 + X^4 + 1$. This 8-bit CRC is received in the true (noninverted) form, and it is computed at the factory and lasered into the ROM.

The other CRC is a 16-bit type, generated according to the standardized CRC-16 polynomial function $X^{16} + X^{15} + X^2 + 1$. This CRC is used for error detection when reading register pages or the data-log memory using the Read Memory with CRC command and for fast verification of a data transfer when writing to or reading from the scratchpad. In contrast to the 8-bit CRC, the

16-bit CRC is always communicated in the inverted form. A CRC generator inside the DS1922L/DS1922T (Figure 15) calculates a new 16-bit CRC as shown in the command flowchart of Figure 9. The bus master compares the CRC value read from the device to the one it calculates from the data and decides whether to continue with an operation or to reread the portion of the data with the CRC error. With the initial pass through the Read Memory with CRC flowchart, the 16-bit CRC value is the result of shifting the command byte into the cleared CRC generator, followed by the two address bytes and the data bytes. The password is excluded from the CRC calculation. Subsequent passes through the Read Memory with CRC flowchart generate a 16-bit CRC that is the result of clearing the CRC generator and then shifting in the data bytes.

With the Write Scratchpad command, the CRC is generated by first clearing the CRC generator and then shift-

Temperature Logger *i*Button with 8KB Data-Log Memory

DS1922L/DS1922T

ing in the command code, the target addresses TA1 and TA2, and all the data bytes. The DS1922L/DS1922T transmit this CRC only if the data bytes written to the scratchpad include scratchpad ending offset 11111b. The data can start at any location within the scratchpad.

With the Read Scratchpad command, the CRC is generated by first clearing the CRC generator and then

shifting in the command code, the target addresses TA1 and TA2, the E/S byte, and the scratchpad data starting at the target address. The DS1922L/DS1922T transmit this CRC only if the reading continues through the end of the scratchpad, regardless of the actual ending offset. For more information on generating CRC values, refer to Application Note 27.

Command-Specific 1-Wire Communication Protocol—Legend

SYMBOL	DESCRIPTION
RST	1-Wire reset pulse generated by master.
PD	1-Wire presence pulse generated by slave.
Select	Command and data to satisfy the ROM function protocol.
WS	Command "Write Scratchpad."
RS	Command "Read Scratchpad."
CPS	Command "Copy Scratchpad with Password."
RMC	Command "Read Memory with Password and CRC."
CM	Command "Clear Memory with Password."
FC	Command "Forced Conversion."
SM	Command "Start Mission with Password."
STP	Command "Stop Mission with Password."
TA	Target Address TA1, TA2.
TA-E/S	Target Address TA1, TA2 with E/S byte.
<Data to EOS>	Transfer of as many data bytes as are needed to reach the scratchpad offset 1Fh.
<Data to EOP>	Transfer of as many data bytes as are needed to reach the end of a memory page.
<Data to EOM>	Transfer of as many data bytes as are needed to reach the end of the data-log memory.
<PW/Dummy>	Transfer of 8 bytes that either represent a valid password or acceptable dummy data.
<32 Bytes>	Transfer of 32 bytes.
<Data>	Transfer of an undetermined amount of data.
FFh	Transmission of one FFh byte.
$\overline{\text{CRC-16}}$	Transfer of an inverted CRC-16.
FF Loop	Indefinite loop where the master reads FF bytes.
AA Loop	Indefinite loop where the master reads AA bytes.

Temperature Logger *i*Button with 8KB Data-Log Memory

Command-Specific 1-Wire Communication Protocol—Color Codes

Master-to-Slave	Slave-to-Master
-----------------	-----------------

1-Wire Communication Examples

Write Scratchpad, Reaching the End of the Scratchpad (Cannot Fail)

RST	PD	Select	WS	TA	<Data to EOS>	CRC-16	FF Loop
-----	----	--------	----	----	---------------	--------	---------

Read Scratchpad (Cannot Fail)

RST	PD	Select	RS	TA-E/S	<Data to EOS>	CRC-16	FF Loop
-----	----	--------	----	--------	---------------	--------	---------

Copy Scratchpad with Password (Success)

RST	PD	Select	CPS	TA-E/S	<PW/Dummy>	AA Loop
-----	----	--------	-----	--------	------------	---------

Copy Scratchpad with Password (Fail TA-E/S or Password)

RST	PD	Select	CPS	TA-E/S	<PW/Dummy>	FF Loop
-----	----	--------	-----	--------	------------	---------

Read Memory with Password and CRC (Success)

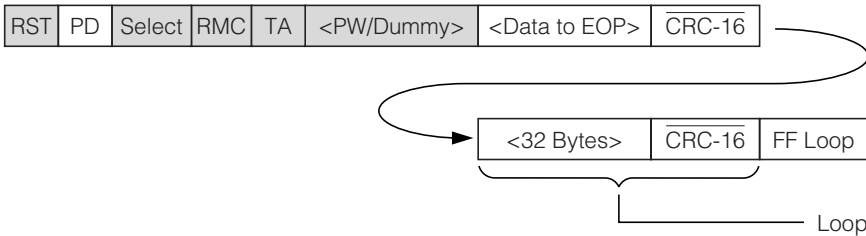

Read Memory with Password and CRC (Fail Password or Address)

RST	PD	Select	RMC	TA	<PW/Dummy>	FF Loop
-----	----	--------	-----	----	------------	---------

Clear Memory with Password

RST	PD	Select	CM	<PW/Dummy>	FFh	FF Loop
-----	----	--------	----	------------	-----	---------

To verify success, read the General Status register at address 0215h. If MEMCLR is 1, the command was executed successfully.

Temperature Logger *i*Button with 8KB Data-Log Memory

DS1922L/DS1922T

1-Wire Communication Examples (continued)

Forced Conversion

RST	PD	Select	FC	FFh	FF Loop
-----	----	--------	----	-----	---------

To read the result and to verify success, read the addresses 020Ch to 020Fh (results) and the Device Samples Counter at address 0223h to 0225h. If the count has incremented, the command was executed successfully.

Start Mission with Password

RST	PD	Select	SM	<PW/Dummy>	FFh	FF Loop
-----	----	--------	----	------------	-----	---------

To verify success, read the General Status register at address 0215h. If MIP is 1 and MEMCLR is 0, the command was executed successfully.

Stop Mission with Password

RST	PD	Select	STP	<PW/Dummy>	FFh	FF Loop
-----	----	--------	-----	------------	-----	---------

To verify success, read the General Status register at address 0215h. If MIP is 0, the command was executed successfully.

Mission Example: Prepare and Start a New Mission

Assumption: The previous mission has been ended by using the Stop Mission command. Passwords are not enabled. The device is a DS1922L.

Starting a mission requires three steps:

- Step 1: Clear the data of the previous mission.
- Step 2: Write the setup data to register page 1.
- Step 3: Start the new mission.

Step 1: Clear the data of the previous mission.

With only a single device connected to the bus master, the communication of step 1 looks like this:

MASTER MODE	DATA (LSB FIRST)	COMMENTS
Tx	(Reset)	Reset pulse
Rx	(Presence)	Presence pulse
Tx	CCh	Issue "Skip ROM" command
Tx	96h	Issue "Clear Memory" command
Tx	<8 FFh bytes>	Send dummy password
Tx	FFh	Send dummy byte
Tx	(Reset)	Reset pulse
Rx	(Presence)	Presence pulse

Temperature Logger *i*Button with 8KB Data-Log Memory

Step 2: Write the setup data to register page 1.

During the setup, the device needs to learn the following information:

- Time and Date
- Sample Rate
- Alarm Thresholds

- Alarm Controls (Response to Conditional Search)
- General Mission Parameters (e.g., Channels to Log and Logging Format, Rollover, Start Mode)
- Mission Start Delay

The following data sets up the DS1922L for a mission that logs temperature using 8-bit format.

ADDRESS	DATA	EXAMPLE VALUES	FUNCTION
0200h	00h	15:30:00 hours	Time
0201h	30h		
0202h	15h		
0203h	01h	1st of April in 2002	Date
0204h	04h		
0205h	02h		
0206h	0Ah	Every 10 minutes (EHSS = 0)	Sample rate
0207h	00h		
0208h	52h	0°C low	Temperature Alarm Thresholds
0209h	66h	10°C high	
020Ah	00h	(Don't care)	(Not applicable with DS1922L/DS1922T)
020Bh	FFh		
020Ch	FFh		
020Dh	FFh		
020Eh	FFh	(Don't care)	Clock through read-only registers
020Fh	FFh		
0210h	02h	Enable high alarm	Temperature Alarm Control
0211h	FCh	Disabled	(Not applicable with DS1922L/DS1922T)
0212h	01h	On (enabled), EHSS = 0 (low sample rate)	RTC Oscillator Control, sample rate selection
0213h	C1h	Normal start; no rollover; 8-bit temperature log	General Mission Control
0214h	FFh	(Don't care)	Clock through read-only registers
0215h	FFh		
0216h	5Ah	90 minutes	Mission Start Delay
0217h	00h		
0218h	00h		

Temperature Logger iButton with 8KB Data-Log Memory

DS1922L/DS1922T

With only a single device connected to the bus master, the communication of step 2 looks like this:

MASTER MODE	DATA (LSB FIRST)	COMMENTS	
Tx	(Reset)	Reset pulse	
Rx	(Presence)	Presence pulse	
Tx	CCh	Issue "Skip ROM" command	
Tx	0Fh	Issue "Write Scratchpad" command	
Tx	00h	TA1, beginning offset = 00h	
Tx	02h	TA2, address = 0200h	
Tx	<25 Data Bytes>	Write 25 bytes of data to scratchpad	
Tx	<7 FFh Bytes>	Write through the end of the scratchpad	
Tx	(Reset)	Reset pulse	
Rx	(Presence)	Presence pulse	
Tx	CCh	Issue "Skip ROM" command	
Tx	AAh	Issue "Read Scratchpad" command	
Rx	00h	Read TA1, beginning offset = 00h	
Rx	02h	Read TA2, address = 0200h	
Rx	1Fh	Read E/S, ending offset = 1Fh, flags = 0h	
Rx	<32 Data Bytes>	Read scratchpad data and verify	
Tx	(Reset)	Reset pulse	
Rx	(Presence)	Presence pulse	
Tx	CCh	Issue "Skip ROM" command	
Tx	99h	Issue "Copy Scratchpad" command	
Tx	00h	TA1	(AUTHORIZATION CODE)
Tx	02h	TA2	
Tx	1Fh	E/S	
Tx	<8 FFh Bytes>	Send dummy password	
Tx	(Reset)	Reset pulse	
Rx	(Presence)	Presence pulse	

Step 3: Start the new mission.

With only a single device connected to the bus master, the communication of step 3 looks like this:

If step 3 was successful, the MIP bit in the General Status register is 1, the MEMCLR bit is 0, and the Mission Start Delay counts down.

MASTER MODE	DATA (LSB FIRST)	COMMENTS
Tx	(Reset)	Reset pulse
Rx	(Presence)	Presence pulse
Tx	CCh	Issue "Skip ROM" command
Tx	CCh	Issue "Start Mission" command
Tx	<8 FFh Bytes>	Send dummy password
Tx	FFh	Send dummy byte
Tx	(Reset)	Reset pulse
Rx	(Presence)	Presence pulse

Temperature Logger *i*Button with 8KB Data-Log Memory

Software Correction Algorithm for Temperature

The accuracy of high-resolution temperature conversion results (forced conversion as well as temperature logs) can be improved through a correction algorithm. The data needed for this software correction is stored in the calibration memory (memory page 18, duplicated in page 19). This data consists of reference temperature (T_r) and conversion result (T_c) for two different temperatures. See the *Temperature Conversion* section for the binary number format.

The software correction algorithm requires two additional values, which are not stored in the device. These values, $Tr1$ and $Offset$, are derived from the device configuration byte.

The correction algorithm consists of two steps: preparation and execution. By means of the family code the preparation step verifies whether the device actually is a DS1922. Then the configuration byte is checked to identify the type of DS1922 (L or T). If it is the correct device, the data for software correction is read and converted from binary to decimal °C format. Next, three coefficients A, B, and C are computed. In the execution step, the temperature reading as delivered by the DS1922 is first converted from the low-byte/high-byte format (T_{cL} , T_{cH}) to °C (T_c) and then corrected to T_{CORR} . Once step 1 is performed, the three coefficients can be used repeatedly to correct any temperature reading and temperature log of the same device.

ADDRESS	DESIGNATOR	DESCRIPTION
0240h	Tr2H	Cold-reference temperature, high byte
0241h	Tr2L	Cold-reference temperature, low byte
0242h	Tc2H	Conversion result at cold-reference temperature, high byte
0243h	Tc2L	Conversion result at cold-reference temperature, low byte
0244h	Tr3H	Hot-reference temperature, high byte
0245h	Tr3L	Hot-reference temperature, low byte
0246h	Tc3H	Conversion result at hot-reference temperature, high byte
0247h	Tc3L	Conversion result at hot-reference temperature, low byte

Step 1. Preparation

Read the 64-bit ROM to obtain the family code. If family code \neq 41h, then stop (wrong device).

Read the configuration byte at address 0226h.

If code = 40h, then $Tr1 = 60$, $Offset = 41$ (DS1922L)

If code = 60h, then $Tr1 = 90$, $Offset = 1$ (DS1922T)

For all other codes, stop (wrong device).

$Tr2 = Tr2H/2 + Tr2L/512 - Offset$ (convert from binary to °C)

$Tr3 = Tr3H/2 + Tr3L/512 - Offset$ (convert from binary to °C)

$Tc2 = Tc2H/2 + Tc2L/512 - Offset$ (convert from binary to °C)

$Tc3 = Tc3H/2 + Tc3L/512 - Offset$ (convert from binary to °C)

$Err2 = Tc2 - Tr2$

$Err3 = Tc3 - Tr3$

$Err1 = Err2$

$B = (Tr2^2 - Tr1^2) \times (Err3 - Err1) / [(Tr2^2 - Tr1^2) \times (Tr3 - Tr1) + (Tr3^2 - Tr1^2) \times (Tr1 - Tr2)]$

$A = B \times (Tr1 - Tr2) / (Tr2^2 - Tr1^2)$

$C = Err1 - A \times Tr1^2 - B \times Tr1$

Step 2. Execution

$T_c = T_{cH}/2 + T_{cL}/512 - Offset$ (convert from binary to °C)

$T_{CORR} = T_c - (A \times T_c^2 + B \times T_c + C)$ (the actual correction)

Temperature Logger iButton with 8KB Data-Log Memory

DS1922L/DS1922T

Numerical Correction Example

CONVERTED DATA FROM CALIBRATION MEMORY	ERROR VALUES
Tr1 = 60°C	—
Tr2 = -10.1297°C	Err2 = 0.0672°C
Tr3 = 24.6483°C	Err3 = -0.1483°C
Tc2 = -10.0625°C	Err1 = 0.0672°C
Tc3 = 24.5°C	—

RESULTING CORRECTION COEFFICIENTS	APPLICATION OF CORRECTION COEFFICIENTS TO SAMPLE READING
B = -0.008741	—
A = 0.000175/°C	T _C = 22.500°C
C = -0.039332°C	T _{CORR} = 22.647°C

Note: The software correction requires floating-point arithmetic (24 bit or better). Suitable math libraries for microcontrollers are found on various websites and are included in cross compilers.

Pin Configuration

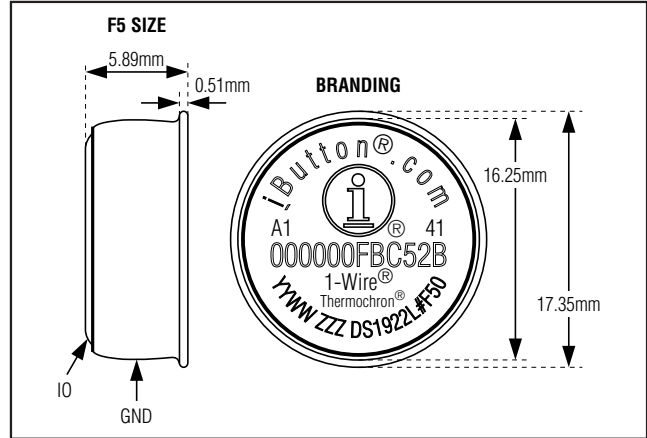

Package Information

For the latest package outline information and land patterns (footprints), go to www.maxim-ic.com/packages. Note that a "+", "#", or "-" in the package code indicates RoHS status only. Package drawings may show a different suffix character, but the drawing pertains to the package regardless of RoHS status.

PACKAGE TYPE	PACKAGE CODE	OUTLINE NO.	LAND PATTERN NO.
F5 iButton	IB#6CB	21-0266	—

Thermochron is a registered trademark of Maxim Integrated Products, Inc.

Temperature Logger *i*Button with 8KB Data-Log Memory

Revision History

REVISION NUMBER	REVISION DATE	DESCRIPTION	PAGES CHANGED
7	12/07	Added bullet "Water resistant or waterproof if placed inside DS9107 <i>i</i> Button capsule (Exceeds Water Resistant 3 ATM requirements)"; deleted "application pending" from UL bullet and safety statement; added text to <i>Application</i> section: Note that the initial sealing level of DS1922L/DS1922T achieves IP56. Aging and use conditions can degrade the integrity of the seal over time, so for applications with significant exposure to liquids, sprays, or other similar environments, it is recommended to place the Thermochron in the DS9107 <i>i</i> Button capsule. The DS9107 provides a watertight enclosure that has been rated to IP68 (See www.maximic.com/AN4126)	1, 4, 12
8	4/09	Created newer template-styled data sheet	All
9	10/09	Deleted the standard part numbers from the <i>Ordering Information</i> table	1
10	4/11	Updated UL certificate reference; deleted ϵ from the t_{W1L} specification in the <i>Electrical Characteristics</i> table; applied note 14 to the t_{W0L} specification in the <i>Electrical Characteristics</i> table; added more details to <i>Electrical Characteristics</i> table notes 5, 14, and 15; revised the last sentence of the <i>Parasite Power</i> section for more clarity; added paragraph on validation certificates to <i>Detailed Description</i> section; added more details on the Device Samples Counter in the <i>Other Indicators</i> section	1, 3, 4, 13, 25

Maxim cannot assume responsibility for use of any circuitry other than circuitry entirely embodied in a Maxim product. No circuit patent licenses are implied. Maxim reserves the right to change the circuitry and specifications without notice at any time.

52 **Maxim Integrated Products, 120 San Gabriel Drive, Sunnyvale, CA 94086 408-737-7600**