

- Round solution
- Designed for navigating a display or controlling a unit
- 90° R=17.5 mm; Ø14.3 mm (Ø34.25 mm)
- h =12.2 mm; 11.7 mm
- Material: ABS/polycarbonate
- Temp. Range:
 - Solid cap: -40/+65°C
 - Transparent cap: -40/+85°C
- Panel cut-out: 1ZB-R₁ 7,1 R₂ 17,5 – 17,75 90° 1ZCS-Ø14.7
- navimec™ panel cut-out: Ø35,0 - 35,5 Depending on application

All dimensions in mm

Tolerances +/-0.2mm



DIMENSIONS

TH + 1ZB



SMD w/LED + 1ZCS

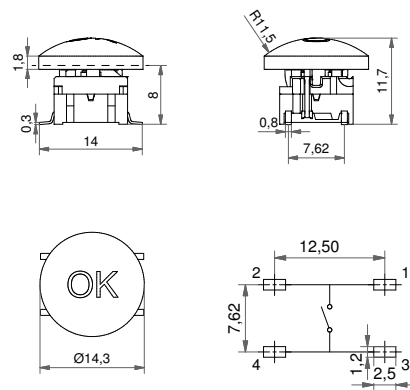

PCB layout for Navimec solution



We recommend using through-hole terminals for precise placing.

ILLUMINATED – HOW TO ORDER

Switch	Mounting	Actuation force	LED	Cap	Legend code
5 G	<input type="checkbox"/> <input type="checkbox"/> <input type="checkbox"/>	<input type="checkbox"/> <input type="checkbox"/>	<input type="checkbox"/> <input type="checkbox"/> <input type="checkbox"/> <input type="checkbox"/>	+ 1 Z B 1 6	<input type="checkbox"/> <input type="checkbox"/> <input type="checkbox"/>
	TH9 through-hole (SH9) surface mount	20 35 65 Q*	02 blue 22 green 42 yellow 61 white 82 red 2242 green/yellow 8222 red/green 8242 red/yellow	Frosted white with black hard paint and laser marking	DLMH136 ▲
					<input type="checkbox"/> <input type="checkbox"/> <input type="checkbox"/>
				1 Z C S 1 6	LMH118 OK LMH123 ⏻

*For an illuminated quiet 2.0N switch add Q to the end of the switch part number.

NON-ILLUMINATED – HOW TO ORDER

Switch	Mounting	Actuation force	Cap	Colour code	Legend code**
5 G	<input type="checkbox"/> <input type="checkbox"/> <input type="checkbox"/>	<input type="checkbox"/> <input type="checkbox"/>	+ 1 Z B	<input type="checkbox"/> <input type="checkbox"/>	<input type="checkbox"/> <input type="checkbox"/> <input type="checkbox"/>
	TH9 through-hole (SH9) surface mount	20 20Q 35 65		03 grey 06 white 09 black 30 ultra blue 40 dusty blue 42 aqua blue	50 metal dark blue 53 metal light grey 57 metal dark grey 58 metal bordeaux
			1 Z C S		D136 ▲
					<input type="checkbox"/> <input type="checkbox"/> <input type="checkbox"/>
					038 RESET 105 ENTER 118 OK 119 SET
					120 MENU 121 FUNC 122 HOME 123 ⏻

** White legends on black caps are standard, other options are available but considered custom products. See pages 34-35 or www.mec.dk

Ordering example: 4x 5GTH93561+1ZB16DLMH13609 + 1x 5GTH93561+1ZCS16LMH12309 (with illumination) OR 4x 5GSH920+1ZB09 + 1x 5GSH920+1ZCS09 (without illumination) OR *5GTH92002Q (Illuminated quiet version)

Please see colour codes, updates of products and changes of specifications on www.mec.dk

Legends

Available for Multimec caps

standard legends

LEGEND	1B09U_ 1B09D_	1DS09_	1FS096R_	1ZB09D_ 1ZB16DLMH_	1ZCS_	10R_ & 10RF_ 10RM16_	10Q_ 10QM16_
0	000	000	000				
1	001	001	001				
2	002	002	002				
3	003	003	003				
4	004	004	004				
5	005	005	005				
6	006	006	006				
7	007	007	007				
8	008	008	008				
9	009	009	009				
#		107	107				
*		019	019				
→		033					
←		133					
↑		034					
↓		134					
↶		135	135				
+						054	054
-						059	059
▲				136*			
⏻		123	123		123*	123	123
ON/OFF						017	017
STOP						018	018
START						031	031
RESET					038	038	038
CANCEL						048	048
ENTER					105	105	105
ESC					051		
OK					118*	118	118
SET					119		
MENU					120		
FUNC					121		
HOME					122		

STANDARD OPTIONS

1B
pad printed

1DS
pad printed

1FS
reverse printed

1ZB
pad printed
*laser marked

1ZCS
pad printed
*reverse printed
*laser marked

10R(F) & 10Q
pad printed
reverse printed

10RM & 10QM
metal symbol

Legends

Available for Multimec caps

how to order

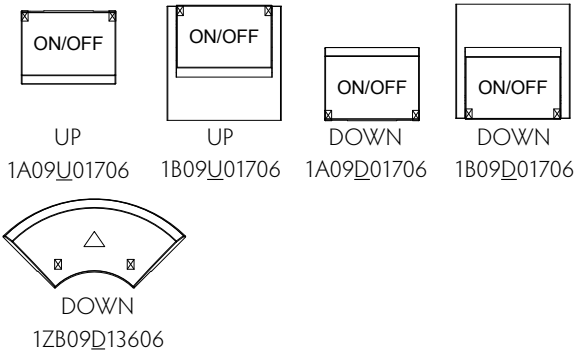

POSITIONING OF LEGENDS ON ROCKER-ACTION CAPS

When ordering legends for caps with hinge-type cap retention system, it is important to note the position of the cap. An extra letter (U or D) needs to be added to the part number to refer to the position of the hinges in relation to the legend. See samples to the left.

Rocker-action caps without a lens: 1A, 1B, 1M, 1ZA and 1ZB

Orientation of the switch:



LEGEND ILLUMINATION

Option 1: LASER MARKED

In case of laser marked legends an "LM" is added after the cap colour, before the legend code. We recommend using hard paint (additional "H") for increased lifetime of the paint. E.g. 1ZB16DLMH13609

Option 2: REVERSE PRINTED

In case of reverse printed caps an "R" is added after the cap colour, before the legend code. Especially relevant when standard legends has both negative and positive print option. E.g. 1FS096R00009

Option 3: METAL SYMBOL

Only available for 10RM and 10QM (therefore the "M"). E.g. 10RM16059

STANDARD AND CUSTOM LEGENDS - HOW TO ORDER

STANDARD LEGENDS

- Standard are only certain legends on certain caps. See the table on the previous page.
- All standard pad-printed legends are white on black caps.
- All standard reverse-printed and laser marked legends are black on frosted white cap.

Cap	Cap colour	Direction*	Type*	Legend	Legend colour*
□□□□	□□	□□	□□□□	□□□□	□□
1B	00 blue	D down	LM laser marked on soft paint	001 1	00 blue
1DS	02 green	U up	LMH laser marked on hard paint	002 2	02 green
... etc	03 grey		R reverse printed	003 3	03 grey
	04 yellow	*only for hinge-type caps	*in case of illumination	... etc	04 yellow
	06 white				06 white
	08 red				08 red
	09 black				09 black
	16 frosted white				... etc
	... etc				

*in case of laser marked legends the colour of the soft or hard paint

NOTE:

- The size of the legends listed may not correspond to the actual size.
- If you decide to use one of the standard legends without any adjustments (without a new cliché) on another cap than designated in the table, then there is no start-up cost, for this to apply the cap has to be black and the print white.
- Standard legend colours are white paint on a black cap and black paint on a frosted white cap. Other colour combinations are handled as custom.
- For further information on legends please contact your local distributor or MEC.

PLEASE FIND THE FULL LIST OF AVAILABLE LEGENDS ON MEC WEBSITE www.mec.dk

Ordering example: 1ZW0913611806; 1B06U13508; 10R16R10509

Please see colour codes, updates of products and changes of specifications on www.mec.dk

No.	00		02		03		04		06		08		09	
Colour	blue		green		grey		yellow		white		red		black	
RAL Code	5012		6018		7004		1023		9010		3000		9004	

No.	30		32		33		34		38		40		42	
Colour	ultra blue		mint green		tele grey		melon		noble red		dusty blue		aqua blue	
RAL Code	5002		6029		7046		1028		3002		5014		5021	

Metallic Colours

No.	50		53		57		58	
Colour	dark blue		light grey		dark grey		bordeaux	
RAL Code	No Ral Code		No Ral Code		No Ral Code		No Ral Code	

CAP CODE		00	02	03	04	06	08	09	30	32	33	34	38	40	42	50	53	57	58
1A		•	•	•	•	•	•	•											
1B		•	•	•	•	•	•	•											
1C				•			•	•											
1DS		•	•	•	•	•	•	•	•	•	•	•	•	•	•	•	•	•	•
1ES/1FS		•	•	•	•	•	•	•											
1GAS/1GCS		•	•	•	•	•	•	•											
1H				•				•											
1JS		•	•	•	•	•	•	•											
1KS		•	•	•	•	•	•	•											
1M		•	•	•	•	•	•	•											
1NS				•				•											
1PS		•	•	•	•	•	•	•											
1QS/1RS		•		•				•											
1SS/1LS		•	•	•	•	•	•	•											
1TS/1US/1VS		•		•			•	•											
1WAS/1WDS/1WPS		•		•			•	•	•					•	•		•	•	
1XS		•	•	•	•	•	•	•											
1ZA				•		•		•	•					•	•	•	•	•	•
1ZB				•		•		•	•					•	•	•	•	•	•
1ZCS				•		•		•	•					•	•	•	•	•	•
1Z/1ZW		•		•		•		•											
10R/10RF + 10Q		•	•	•	•	•	•	•											



- Module should be attached to the front plate with bolts (bolts not supplied by MEC)
- Round solution
- Ø34.25 mm
- h = 11.7 mm; 12.2 mm
- Temp. Range:
 - Solid cap: -40/+65°C
 - Transparent cap: -40/+85°C
- Recommended panel cut-out: Ø35,0 - 35,5 Depending on application

All dimensions in mm

Tolerances +/-0.2mm

DIMENSIONS

Navimec Module

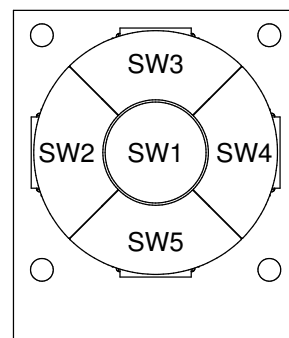

When the 1ZB is activated the diameter changes from 34,25 mm to 35,0 mm

HOW TO ORDER

navimec[™] Module ordering options:

- navimec[™] Module excl. keycaps
- navimec[™] Module incl. keycaps
- navimec[™] Module incl. keycaps with legends
- Illuminated navimec[™] Module excl. keycaps
- Illuminated navimec[™] Module incl. keycaps with legends

Part no. for a module:

navimec[™] Module has many customisation options regarding actuation force, cap and LED colours and legends. Because of that "How to order" has been placed on page 43.

See previous page for information on switch and cap options.

SEE THE "HOW TO ORDER" GRAPH AS WELL AS CIRCUIT DIAGRAM AND CONNECTOR INFO ON [PAGE 43](#)

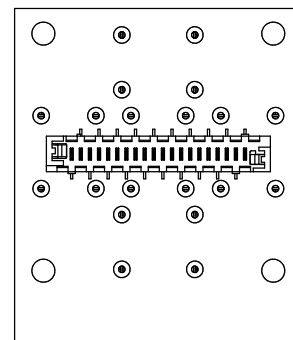

Ordering example:

95NA200913611806 (without illumination)

95NB350116LMH13612309 (with illumination)

Please see colour codes, updates of products and changes of specifications on www.mec.dk

Circuit diagram for switches



Circuit diagram for additional LEDs for controlmec™



Connectors on the module are Molex picoflex series 90816-0320 for switches and 90816-0316 for additional LEDs.
We recommend using:
Cable socket: 90327-0320 for switches and 90327-0316 for additional LEDs

HOW TO ORDER - MODULES

Module	Cap	Type	Actuation force	LED*
<input type="checkbox"/> 9 <input type="checkbox"/> 5	<input type="checkbox"/>	<input type="checkbox"/>	<input type="checkbox"/> <input type="checkbox"/>	<input type="checkbox"/> <input type="checkbox"/>
C controlmec module	A non-illuminated	20 2.0N**	02 blue	2242 green/yellow
N navimec module	B illuminated	35 3.5N	22 green	8222 red/green
Q 10Q module	<u>Sealed controlmec module:</u>	65 6.5N	42 yellow	8242 red/yellow
R 10R module	C non-illuminated		61 white	
	D illuminated		82 red	

Cap colour	Legend type*	Legend on the edges*	Legend in the centre*	Legend colour*
<input type="checkbox"/> <input type="checkbox"/>	<input type="checkbox"/> <input type="checkbox"/> <input type="checkbox"/>	<input type="checkbox"/> <input type="checkbox"/> <input type="checkbox"/>	<input type="checkbox"/> <input type="checkbox"/>	<input type="checkbox"/> <input type="checkbox"/>
09 black	(nothing) pad printed	136 ▲	118 OK	06 white
16 frosted white	LMH hard paint laser marked		123 ☺	09 black
	M Metal		***Find more options on mec.dk	

*optional, ** 2.0N actuation force not recommended for controlmec

Ordering example:
 95CB358216LMH13611809 - illuminated non-sealed controlmec
 95CC650913612306 - non-illuminated panel sealed controlmec
 95NB358216LMH13611809 - illuminated Navimec module
 95QB200116M118 - illuminated 10Q module
 95RA350912306 - non-illuminated 10R module
 Please see colour codes, updates of products and changes of specifications on www.mec.dk



- Through-hole (TH) or surface mount (SMD)
- 50mA/24VDC
- Single pole/momentary
- 10,000,000 operations lifetime (NO function)
- Temperature range:
 - Switch: -40/+160°C
 - LED: -40/+85°C
- IP 67 sealing
- Actuation force: 2.0N, 3.5N, 6.5N
- NO or NC/NO

All dimensions in mm

Tolerances +/-0.2mm

THROUGH-HOLE (TH)

5G



5G illuminated

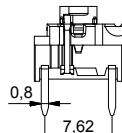

5E

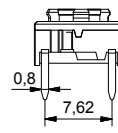

PCB LAYOUT

Non-illuminated

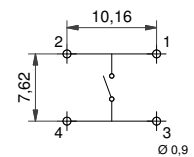

1 LED

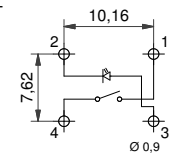

2 LED

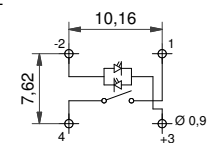

SURFACE MOUNT (SMD)

5G

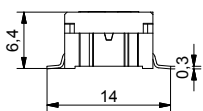

5G illuminated



5E

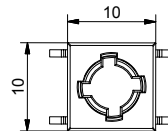
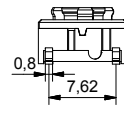
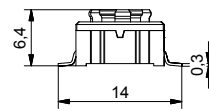

PCB LAYOUT

Non-illuminated

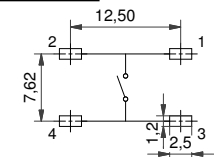

1 LED

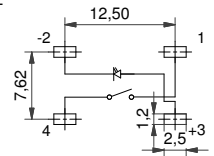

2 LED

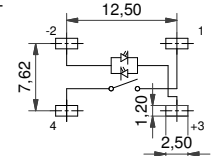

NORMALLY CLOSED/NORMALLY OPEN FUNCTION

NOT FOR SALE IN JAPAN

CIRCUIT DIAGRAM

- Available for 5E and non-illuminated 5G in 3.5N actuation force.
- Same PCB layout as the NO 5E and 5G
- Housing colour is **grey**



RIGHT ANGLE SWITCHES

PCB LAYOUT

5E



5G



5G + 1SS



5G + 1DS

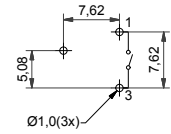

multimec® 5 series has only normally open (NO) non-illuminated right angle switch.

ILLUMINATED – HOW TO ORDER

Switch	Mounting	Actuation force	LED	Quiet (optional)
5 G	<input type="checkbox"/> <input type="checkbox"/> <input type="checkbox"/>	<input type="checkbox"/> <input type="checkbox"/> <input type="checkbox"/>	<input type="checkbox"/> <input type="checkbox"/> <input type="checkbox"/>	<input type="checkbox"/>
	TH9 through-hole SH9 surface mount	20 35 65	02 blue 22 green 42 yellow 61 white	Q only for 2.0N
			82 red 2242 green/yellow 8222 red/green 8242 red/yellow	

NON-ILLUMINATED – HOW TO ORDER

Switch	Mounting	Actuation force	RAS (optional)	or	NC/NO (only for 3.5N)
5 E	<input type="checkbox"/> <input type="checkbox"/> <input type="checkbox"/>	<input type="checkbox"/> <input type="checkbox"/> <input type="checkbox"/>	<input type="checkbox"/> <input type="checkbox"/> <input type="checkbox"/>		<input type="checkbox"/> <input type="checkbox"/> <input type="checkbox"/> <input type="checkbox"/>
	TH9 through-hole SH9 surface mount	20 20Q 35 65	RAS right angle switch		NCNO normally closed/ normally open function

Switch	Mounting	Actuation force	RAS (optional)	or	NC/NO (only for 3.5N)
5 G	<input type="checkbox"/> <input type="checkbox"/> <input type="checkbox"/>	<input type="checkbox"/> <input type="checkbox"/> <input type="checkbox"/>	<input type="checkbox"/> <input type="checkbox"/> <input type="checkbox"/>		<input type="checkbox"/> <input type="checkbox"/> <input type="checkbox"/> <input type="checkbox"/>
	TH9 through-hole SH9 surface mount	20 20Q 35 65	RAS right angle switch		NCNO normally closed/ normally open function

Ordering example: 5ESH935 (non-illuminated), 5GTH9658222 (illuminated), 5GSH935NCNO (normally closed/normally open); 5ETH920RAS (right angle) 5ETH920Q or 5GSH92061Q (quiet versions)

Please see colour codes, updates of products and changes of specifications on www.mec.dk

Basic switch spacing

through-hole (TH)



surface mount (SMD)



Recommended switch/cap spacing

Switch spacing



Cap dimensions



Panel cut-out

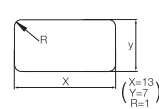

Panel cut-out

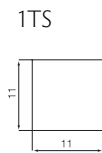
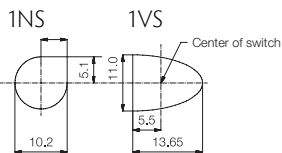

Spacing examples

multimec
5GT+1B/C+2C/D

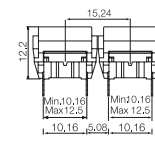

multimec
5GS+1B/C+2C/D

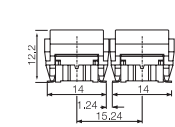

multimec
5GT + 1A/H

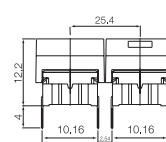

multimec
5GT + 1M

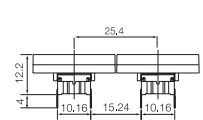

multimec
1NS + 1NS + 1NS

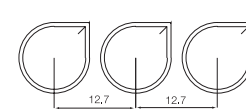

multimec
1VS + 1TS+ 1VS

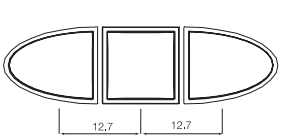

Cap series	Recommended min. switch spacing AxB	Nominal cap dimension WxH	Recommended min. panel cut-out
1A/1H	12.7x10.16	12.6x10.1	13.0x10.5
1B/1C+2C/2D	15.24x15.24	15.1x15.1	15.5x15.5
1DS/1ES/1FS	12.7x12.7	ø9.6	ø10.0
1GAS	12.7x11.14	ø11	ø11.4
1GCS	15.14x15.14	ø15	ø15.4
1JS	12.7x12.7	ø9.6	ø10.4
1KS/1KBS/1KCS	15.24x15.24	14.3x14.3	14.7x14.7
1M	25.4x10.16	25.0x10.	25.7x10.5
1NS	12.7x12.7	ø9.8/□4.9	ø10.2/□5.1
1PS/1QS/1RS	15.24x10.16	6.5x12.5	7.0x13.0, R max. 1.0
1SS/1IS/1LS	12.7x12.7	ø6.5	ø7.0
1TS	12.7x12.7	10.6x10.6	11.0x11.0
1US	12.7x12.7	ø10.6	ø11.0
1VS	12.7x12.7	10.6x13.25	11.0x13.65
1WAS/1WPS	12.7x10.3	12.5x6.5	12.9x6.9
1WDS	15.34x10.3	15.2x8.0	15.6x8.4
1XS	12.7x12.7	9.4x7.4	9.8x7.9
1YS	17x17	15x15	16x16
1ZA	18.84x10.3	18.7x10.1	19.4x10.5
1ZB	24.34x12.1	R1=7.4; R2=17.5 90°	R1=7.1; R2=17.5-17.75 90°
1ZCS	14.44x14.44	ø14.3	ø14.7
1Z/1ZW	35.5x35.5; 41.6x41.6	ø29.5	ø30.3
10R/10RF/10RM	40.5x40.5	ø30.0	ø30.6
10Q/10QM	32.5x32.5	22x22	22.5x22.5

Tape & Reel

Tape and reel is available for the parts listed and has the following specifications:

Reel diameter:	Ø330mm	Tape and reel material:	antistatic or better
Tape width:	24mm	Quantity per reel:	see list
Pitch:	see list		

3C/3E/5E/5G multimec® tape & reel

Part No.	Ordering Code	Pitch	Quantity per reel
3CSH9	3CSH9R	16	500
3ESH9	3ESH9R	16	500
5ESH9XX	5ESH9XXR	16	500
5GSH9XX	5GSH9XXR	16	500
5XSH9XX1SSXX-08.0	5XSH9XXR1SSXX-08.0	20	250
5XSH9XX1SSXX-09.5	5XSH9XXR1SSXX-09.5	20	250
5XSH9XX1SSXX-10.4	5XSH9XXR1SSXX-10.4	20	250
5XSH9XX1SSXX-11.0	5XSH9XXR1SSXX-11.0	20	250
5XSH9XX1SSXX-12.0	5XSH9XXR1SSXX-12.0	20	250
All varimec h <12.5; add R after part no.			20 250

illuminated 5G multimec® tape & reel

Part No.	Ordering Code	Pitch	Quantity per reel
5GSH9XX02	5GSH9XX02R	20	250
5GSH9XX22	5GSH9XX22R	20	250
5GSH9XX42	5GSH9XX42R	20	250
5GSH9XX61	5GSH9XX61R	20	250
5GSH9XX82	5GSH9XX82R	20	250
5GSH9XX2242	5GSH9XX2242R	20	250
5GSH9XX8222	5GSH9XX8222R	20	250
5GSH9XX8242	5GSH9XX8242R	20	250

How to assemble

multimec®
5GS+1A/H

multimec®
5GS+1B/C+2C/D



Operating force

(typical example)



Mounting tool for multimec® through-hole switches

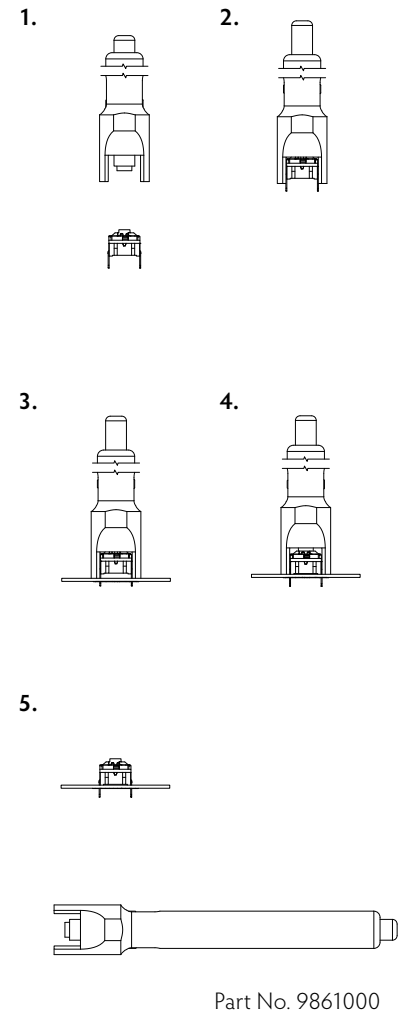

RoHS Compatible

	HIGH TEMPERATURE VERSIONS		
	SILVER	GOLD	NC/NO
ELECTRICAL SPECIFICATIONS			
Contact resistance	<30m Ω - typ. 10m Ω		
Insulation resistance	>10M Ω		
Recommended load	0.5-50mA 24VDC	0.5μ-50mA 24VDC	
Contact bounce	<2mS - typically 0.5mS		
MECHANICAL SPECIFICATIONS			
Standard actuation force (switch)	2.0N, 3.5N, 6.5 N		3.5N
Max. Actuation force without cap	115N for 60 sec	(according to MIL-PRF-22885H)	100N for 10 sec
Key travel (switch)	1 mm		
Life time (switch)	>10,000,000 cycles		>1,000,000 cycles
TEMPERATURE RANGE			
Working temperature	Min -40°C Max +160°C		
Storage temperature	Min -40°C Max +160°C		
5G with LED (working & storage temp)	Min -30°C Max +85°C		
Soldering (through-hole switch)	IEC 68-2-20 8:		
	Infrared, vapour phase, wave - max 240°C for max 40 sec or max 260°C for max 30 sec.		
	Soldering iron - max 350°C for max 3 sec.		
	Flux tight.		
SOLDERING (SMD)	JEDEC J-STD-020C		
ENVIRONMENTAL ENDURANCE IEC 68-2-3			
Temperature	+40°C		
Humidity	93% RH		
Duration	56 Days		
TEMPERATURE CYCLING IEC 68-2-14			
Temperature limit	Min -55°C - Max +85°C		
Number of cycles	200		
Exposure time at each temperature	10 min		
Recovery time before measurements	16 hrs		
Sealing IEC 529	IP-67		
Cleaning	Standard methods - see usage guidelines		
MATERIAL SPECIFICATIONS - SWITCHES			
Housing	PPS UL94V0		
Actuator	PPS UL94V0		
Sealing + spring	Silicone rubber		
Contact spring	Stainless steel		Stainless steel
	+ 3μAg		+ 1μAu
Fixed contacts	SnCu + 2μNI + 3μAg		SnCu + 2μNI + 1μAu
Terminals	SnCu + 2μNI + 3μSn100		

Caps, Bezels & Legends – Material Specifications

MATERIAL	PARTS	TEMP. LIMIT	UL RATING
ABS	1A, 1B, 1C, 1DS, 1ES, 1FS, 1H, 1JS, 1KS, 1LS, 1M, 1NS, 1PS, 1QS, 1RS, 1TS, 1US, 1VS, 1WAS, 1WDS, 1WPS, 1XS, 1Z, 1ZA, 1ZB, 1ZCS, 1ZW, 2C, 2D, 2K, reflectors for 1KBS/1KCS and 1YS	Max. 65°C	UL94HB
Polycarbonate	All lenses and transparent colour caps, lids for 1KBS/1KCS	Max. 85°C	UL94HB
Polyamide	1GAS/1GCS, 1SS, 2SS	Max. 160°C	UL94V2
Legends Adhesion	DS/EN ISO 2409 Class 1 & ASTM D3359 Class 4B		

LEDs specifications

5G switches

Colour		Blue	Green	Yellow	White	Red	High Intensity Green
Colour Codes		02	22	42	61	82	29
ABSOLUTE MAXIMUM RATINGS (Ta=25°C)							
Power	mW	95	75	60	48	65	102.5
Current forward	mA	25	30	25	15	25	25
Forward peak current	mA	100	80	60	100	100	150
Voltage reverse	V	5	5	5	NA	12	5
Operating temperature	°C	-40/+85	-55/+85	-40/+85	-40/+85	-30/+85	-40/+85
Storage temperature	°C	-40/+90	-55/+85	-40/+90	-40/+85	-40/+85	-40/+85
Soldering temperature	°C	245 for max. 10 sec					
ELECTRICAL-OPTICAL CHARACTERISTICS (Ta=25°C)							
Voltage forward	Typ. V	3.3	2	1.75**	2.85	2	3.3
	Max. V	3.7	2.4	2.35	3.1	2.5	4.1
Current reverse (VR=5V)	Max. µA	50	100	10	NA	100	50
Wave length	nm	470	571	591	NA	633	525
Spread	Δnm	25	NA	15	NA	16	30
Spread angle	degree	120	130	120	150	160	60
Luminous Intensity	Min. mcd	45	18	28.5	71	28	500
	Typ. mcd	112*	35	72*	224*	180*	1000
Optical intensity	Lm/w	NA	NA	NA	36	7	NA

*Max.mcd **Min. V

3F switches

3FXXX (for 1E-1F-1N-1Q-1R-1S-1X)

3FXXX (for 1K-1T-1U-1V-1W-1WD)

Colour		B	G	Y	W	R	G/Y	R/G	R/Y	G	Y	R	
Colour Codes		00	20	40	65	80	2040	8020	8040	24	46	87	
Absolute Maximum Ratings	(Ta=25°C)												
Power	mW	105	70	60	120	60	120	100	120	60	60	120	
Current forward	mA	30	20	20	25	20	25	30	25	25	25	50	
Forward peak current	mA	150	60**	60**	100	60**	150	120	150	60	60	200	
Voltage reverse	V	5	3	3	5	3	5	5	5	5	5	5	
Operating temperature	°C	-40/+85			-40/+85	-25/+85	-40/+85	-55/+100	-40/+85	-40/+85	-40/+85	-40/+85	
Storage temperature	°C	-40/+85			-40/+100	-30/+100	-40/+85	-55/+100	-40/+85	-40/+85	-40/+100	-40/+100	
Soldering temperature	°C	260 for max 5 sec						260 for max 2 sec			300 for max 3 sec	260 for max 5 sec	
Electrical-Optical Characteristics (Ta=25°C)													
Voltage forward	Typ. V	3.8	2.1	2.1	3.8	2.0	2.1	2.0	2.1	2.0*	2.0	2.0***	
	Max. V	4.5	3.0	3.0	4.3	3.0	2.8	2.6	2.8	2.4*	2.4	2.4***	
Current reverse (VR=5V)	µA	10	10	10	50	10	2	2	2	10	10	10	
Wave length	nm	466	563	585	NA	650	565/590	630/565	625/590	570	589	624/632	
Spread	Δnm	60	40	40	NA	40	35	35	35	10	NA	20	
Spread angle	degree	60	45	45	25	45	60	200	60	100	40	40	
Luminous Intensity	Min. mcd	18	9.0	5.6	630	5.6	8	2.2	8	70****	630	400****	
	Typ. mcd	50	25	16	1000	16	25	4.8	25	20****	1250	800****	
Orientation	The longer pin is the anode, the shorter is the cathode. For bicolour LEDs the anode for the first colour (ex. 2080) is the longer pin.												

Pulse width 1ms Duty cycle 1:5, */F =50mA, **** Luminous Flux mlm

B=Blue, G=Green, Y=Yellow, R=Red, W=White

Specifications are subject to change without notice.

Specifications are subject to change without notice.

For product updates and/or changes of specifications please see www.mec.dk

Usage guidelines

How to get the best results with MEC Switches?

These guidelines are offered to users of MEC Switches as an aid to ensure successful and reliable switch operation.

Temperature

Both unimec™ and multimec® switches are produced in low and high temperature versions. Please see the technical specifications for details on operating and storage temperatures and soldering guidelines to make sure you select the best switch for your application. When wave soldering is taking place, MEC strongly recommend that the temperature profile is analysed and compared with the temperature rating of the switch. In case of doubt always select the high temperature versions unimec™ 154XX, and multimec® 5XXH9XX. It is also important to monitor the accumulated heat build up from both the pre-heat zones and the solder zone.

Most standard accessories for both unimec™ and multimec® switches are made from ABS plastic with a maximum operating temperature of 65°C. It is strongly recommended that accessories are mounted after soldering of the switch. If this is not possible care must be taken not to overheat the accessories during the soldering process. The 1SS, 1GAS/1GCS and Varimec™ caps are, however, made of high temperature materials and will meet the same temperature specifications as the high temperature switches.

For accessories made from other plastic materials please see multimec® and unimec™ technical specifications.

LEDs have their own temperature specifications. When fitted in a high temperature switch the LED will determine the max. operating temperature, i.e. 5GTH93524 has an upper temperature limit of 85°C! This also applies with 3F switches.

Mounting and Dismounting

If switches are to be mounted in rows it is essential that the recommendations regarding spacing are followed. PC board thickness should be 1.4±0.2 mm and terminal hole diameter should be 0.9mm.

All unimec™ and multimec® caps and bezels are easily snapped onto the switch modules and can be changed at a later time with the exception of the unimec 16.700 cap. The same applies to the 3E caps. Once these caps are installed they are not designed to be removed. To do so may cause damage to the switch and the PC board if not done very carefully. If the 16.300 or 16.700 cap must be removed from a unimec™ alternate action switch, make sure that the switch actuator is in the released, upper position before attempting to remove the cap. This will prevent possible damage to the internal latching pin.

Care must be taken when inserting the 3FT switch and LED assembly into the PC board. Do not press direct on the LED. This will force the LED down into the actuator and risks to cause the switch contacts to remain in the closed position. To correct the fault, the LED must be raised slightly and centered in the actuator to assure unrestricted movement of the actuator. A mounting tool is available for multimec® switches.

Soldering and Cleaning unimec™

Most assembly and field problems experienced by users of unsealed switches are caused by the contamination of the contacts during soldering and cleaning.

Contact contamination may be recognised by an increase in contact resistance and possible intermittent operation of the switch, especially in low power applications. Care must be taken not to submerge the switch in cleaning agents or spray the switch during cleaning. The switch must be protected at all times to prevent contamination by flux or cleaning liquids.

For unimec™ alternate versions we recommend to leave the actuator in the released upper position during soldering. This makes the switch more resistant to overheating.

Soldering and Cleaning multimec®

multimec® switches are fully sealed to IP67 specifications to prevent solder flux and aqueous based cleaning solutions from entering the switch and contaminating the contacts. The switches can be placed on the PC board with other components and wave soldered. multimec® offers a high level of sealing, however, with aqueous solvent solutions care must be taken to avoid the worst case situation with water jets, complete immersion into a liquid with a temperature below the board or surface tension reducing additives.

Recommended cleaning methods are demineralized water. Any surface tension reducing agents, such as soap, must not be used as they risk causing a potential leakage of the switch.

Soldering - Through Hole Versions

Hand soldering: Max. 350°C for max. 3 sec., this applies for both low temperature and high temperature versions.

Wave soldering: heat built up in the switch during pre-heating and soldering must not exceed the maximum operating temperature of the switch. If, for some reason, a high pre-heating temperature is required, MEC recommend the high temperature switches. In any case peak temperature must not exceed 260°C, and soldering time is max 10 sec.

Soldering - Surface Mount Versions

For all methods - infrared, convection and vapour phase. The upper limit 260°C/30 sec must be observed. The soldering temperature profile must have moderate temperature gradients.

RoHS Compliance

As of 1 July 2006 MEC has completed the conversion to RoHS compliance. For more info please see our homepage www.mec.dk

Temperature Limits:

Low temperature switch	115°C
High temperature switch	160°C
LEDs	85/100°C
Accessories	65/85/160°C

Packaging

unimec™ and multimec® switches are packed in rigid tubes of 50 pieces each.

A box contains 1.000 pcs.

The surface mount versions of multimec® switches with a height up to 12.5mm can also be delivered on tape/reel. Each reel contains 250/500 pcs.