

Aluminum Capacitors Axial High Temperature, DIN-Based

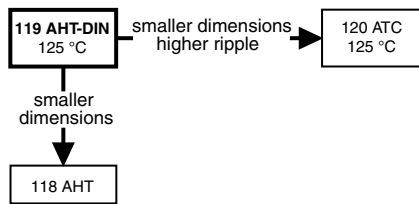


Fig. 1

| QUICK REFERENCE DATA | |
|-------------------------------------------------------------------------------|---------------------------------------------|
| DESCRIPTION | VALUE |
| Nominal case sizes (\varnothing D x L in mm) | 6.5 x 18 to 10 x 25 10 x 30 to 21 x 38 |
| Rated capacitance range, C_R | 4.7 μ F to 4700 μ F |
| Tolerance on C_R | - 10 %/+ 50 % |
| Rated voltage range, U_R | 10 V to 200 V |
| Category temperature range | - 55 °C to + 125 °C |
| Endurance test at 150 °C | 500 h 500 h |
| Endurance test at 125 °C | 2000 h 4000 h |
| Useful life at 125 °C | 4000 h 8000 h |
| Useful life at 40 °C, 1.8 x I_R applied | 500 000 h 1 000 000 h |
| Shelf life at 0 V, 125 °C: U_R = 10 V to 63 V U_R = 100 V and 200 V | 500 h 100 h |
| Based on sectional specification | IEC 60384-4/EN 130300 |
| Climatic category IEC 60068 | 55/125/56 |

FEATURES

- Extra long useful life: Up to 8000 h at 125 °C
- High stability, high reliability
- Extended temperature range: 125 °C (usable up to 150 °C)
- High ripple current capability
- Taped versions up to case \varnothing 15 mm x 30 mm available for automatic insertion
- Polarized aluminum electrolytic capacitors, non-solid electrolyte
- Axial leads, cylindrical aluminum case, insulated with a blue sleeve
- Mounting ring version not available in insulated form
- Charge and discharge proof
- Material categorization: For definitions of compliance please see www.vishay.com/doc?99912


**RoHS
COMPLIANT**

APPLICATIONS

- Military, industrial control, EDP and telecommunication
- Smoothing, filtering, buffering in SMPS; coupling, decoupling
- For use where low mounting height is important; vibration and shock resistant

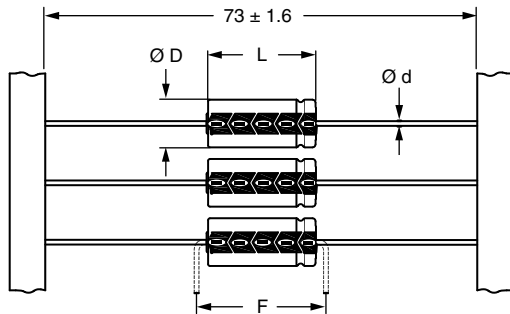
MARKING

The capacitors are marked (where possible) with the following information:

- Rated capacitance (in μ F)
- Tolerance on rated capacitance, code letter in accordance with IEC 60062 (T for - 10 % to + 50 %)
- Rated voltage (in V) at 125 °C and 85 °C
- Date code, in accordance with IEC 60062
- Code for factory of origin
- Name of manufacturer
- Negative terminal identification
- Series number (119)

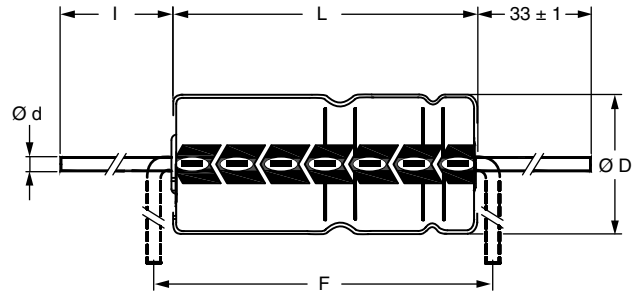
| SELECTION CHART FOR C_R , U_R , AND RELEVANT NOMINAL CASE SIZES (\varnothing D x L in mm) | | | | | | | |
|--------------------------------------------------------------------------------------------------|-----------|----------|----------|-----------|----------|-----------|---------|
| C_R (μ F) | U_R (V) | | | | | | |
| | 10 | 16 | 25 | 40 | 63 | 100 | 200 |
| 4.7 | - | - | - | - | - | 6.5 x 18 | 10 x 18 |
| 10 | - | - | - | - | 6.5 x 18 | 8 x 18 | 10 x 25 |
| 22 | - | - | 6.5 x 18 | - | 8 x 18 | 10 x 18 | - |
| 47 | - | 6.5 x 18 | - | 8 x 18 | 10 x 18 | 10 x 25 | - |
| | - | - | - | - | - | 10 x 30 | - |
| 68 | - | - | - | - | 10 x 30 | 12.5 x 30 | - |
| 100 | 6.5 x 18 | 8 x 18 | 10 x 18 | 10 x 25 | 10 x 30 | 15 x 30 | - |
| 150 | - | - | - | 12.5 x 30 | 15 x 30 | 15 x 30 | - |

| SELECTION CHART FOR C_R , U_R , AND RELEVANT NOMINAL CASE SIZES ($\varnothing D \times L$ in mm) | | | | | | | |
|-------------------------------------------------------------------------------------------------------|-----------|-----------|-----------|-----------|---------|---------|-----|
| C_R (μF) | U_R (V) | | | | | | |
| | 10 | 16 | 25 | 40 | 63 | 100 | 200 |
| 220 | 10 x 18 | 10 x 25 | 10 x 25 | 12.5 x 30 | 15 x 30 | 18 x 30 | - |
| | - | - | 12.5 x 30 | - | - | - | - |
| 330 | - | 12.5 x 30 | 12.5 x 30 | 15 x 30 | 18 x 30 | 18 x 38 | - |
| 470 | 10 x 25 | 12.5 x 30 | 12.5 x 30 | 15 x 30 | 18 x 38 | 21 x 38 | - |
| | 12.5 x 30 | - | - | - | - | - | - |
| 680 | 12.5 x 30 | 15 x 30 | 18 x 30 | 18 x 30 | 21 x 38 | - | - |
| 1000 | 15 x 30 | 15 x 30 | 18 x 30 | 18 x 38 | 21 x 38 | - | - |
| 1500 | 18 x 30 | 18 x 30 | 18 x 38 | 21 x 38 | - | - | - |
| 2200 | 18 x 30 | 18 x 38 | 21 x 38 | 21 x 38 | - | - | - |
| 3300 | 18 x 38 | 21 x 38 | - | - | - | - | - |
| 4700 | 21 x 38 | 21 x 38 | - | - | - | - | - |

DIMENSIONS in millimeters AND AVAILABLE FORMS


Form BR: Taped on reel
 Case $\varnothing D \times L = 6.5 \text{ mm} \times 18 \text{ mm}$ to $15 \text{ mm} \times 30 \text{ mm}$
Form BA: Taped in box (ammopack)
 Case $\varnothing D \times L = 6.5 \text{ mm} \times 18 \text{ mm}$ to $10 \text{ mm} \times 25 \text{ mm}$

Fig. 2 - Forms BA and BR



Form AA: Axial in box
 Case $\varnothing D \times L = 10 \text{ mm} \times 30 \text{ mm}$ to $21 \text{ mm} \times 38 \text{ mm}$

Fig. 3 - Form AA

Table 1

| AXIAL; DIMENSIONS in millimeters, MASS, AND PACKAGING QUANTITIES | | | | | | | | | | |
|------------------------------------------------------------------|-----------|---------------------------|--------|------------------------|------------|------------|----------|----------------------|---------|---------|
| NOMINAL CASE SIZE $\varnothing D \times L$ | CASE CODE | AXIAL FORM AA, BA, AND BR | | | | | MASS (g) | PACKAGING QUANTITIES | | |
| | | $\varnothing d$ | l | $\varnothing D_{max.}$ | $L_{max.}$ | $F_{min.}$ | | FORM AA | FORM BA | FORM BR |
| 6.5 x 18 | 4 | 0.8 | - | 6.9 | 18.5 | 25 | ≈ 1.3 | - | 1000 | 1000 |
| 8 x 18 | 5 | 0.8 | - | 8.5 | 18.5 | 25 | ≈ 1.7 | - | 500 | 500 |
| 10 x 18 | 6 | 0.8 | - | 10.5 | 18.5 | 25 | ≈ 2.5 | - | 500 | 500 |
| 10 x 25 | 7 | 0.8 | - | 10.5 | 25.5 | 30 | ≈ 3.3 | - | 500 | 500 |
| 10 x 30 | 00 | 0.8 | 55 ± 1 | 10.5 | 30.5 | 35 | ≈ 4.8 | 340 | - | 500 |
| 12.5 x 30 | 01 | 0.8 | 55 ± 1 | 13.0 | 30.5 | 35 | ≈ 7.4 | 260 | - | 400 |
| 15 x 30 | 02 | 0.8 | 55 ± 1 | 15.5 | 30.5 | 35 | ≈ 11.7 | 200 | - | 250 |
| 18 x 30 | 03 | 0.8 | 55 ± 1 | 18.5 | 30.5 | 35 | ≈ 12.9 | 120 | - | - |
| 18 x 38 | 04 | 0.8 | 34 ± 1 | 18.5 | 39.5 | 44 | ≈ 19.0 | 125 | - | - |
| 21 x 38 | 05 | 0.8 | 34 ± 1 | 21.5 | 39.5 | 44 | ≈ 24.0 | 100 | - | - |

Note

- For detailed tape dimensions please see www.vishay.com/doc?28361

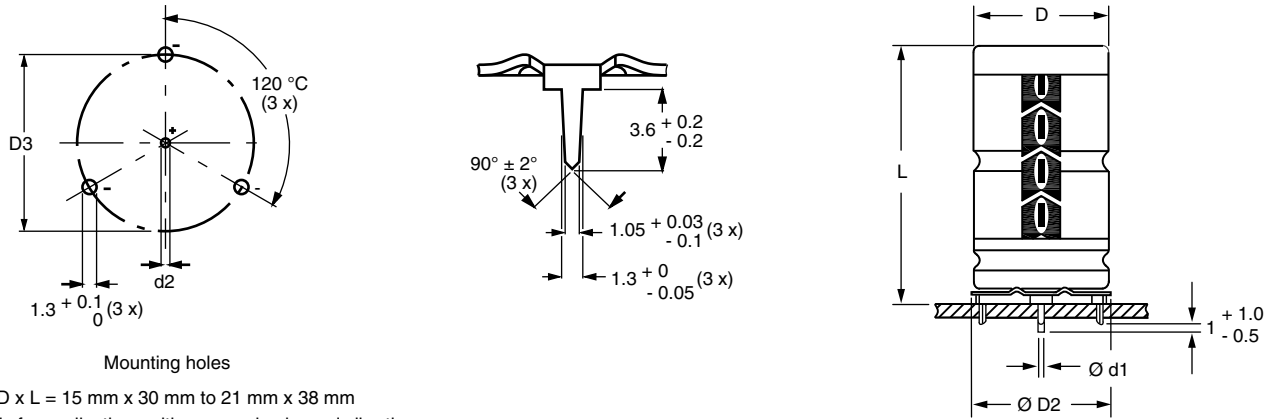

 Fig. 4 - Mounting hole diagram and outline; **form MR:** With mounting ring and pins

Table 2

| MOUNTING RING; DIMENSIONS in millimeters, MASS, AND PACKAGING QUANTITIES | | | | | | | | | |
|----------------------------------------------------------------------------------------|-----------|------------------------|------------------|------------------------|-------------------------|------------|------------|----------|----------------------|
| NOMINAL CASE SIZE $\varnothing D \times L$ | CASE CODE | MOUNTING RING: FORM MR | | | | | | MASS (g) | PACKAGING QUANTITIES |
| | | $\varnothing d1$ | $\varnothing d2$ | $\varnothing D_{max.}$ | $\varnothing D2_{max.}$ | D3 | $L_{max.}$ | | |
| 15 x 30 | 02 | 0.8 | 1.0 + 0.4 | 15.5 | 17.5 | 16.5 ± 0.2 | 33 | ≈ 8.6 | 200 |
| 18 x 30 | 03 | 0.8 | 1.0 + 0.4 | 18.5 | 19.5 | 18.5 ± 0.2 | 33 | ≈ 11.5 | 240 |
| 18 x 38 | 04 | 0.8 | 1.0 + 0.4 | 18.5 | 19.5 | 18.5 ± 0.2 | 42 | ≈ 14.0 | 100 |
| 21 x 38 | 05 | 0.8 | 1.0 + 0.4 | 21.5 | 22.5 | 21.5 ± 0.2 | 42 | ≈ 19.2 | 100 |

| ELECTRICAL DATA | |
|------------------------|------------------------------------------------------------------------------------------|
| SYMBOL | DESCRIPTION |
| C_R | Rated capacitance at 100 Hz, tolerance - 10 %/+ 50 % |
| I_R | Rated RMS ripple current at 100 Hz, 125 °C |
| I_{L1} | Max. leakage current after 1 min at U_R |
| I_{L5} | Max. leakage current after 5 min at U_R |
| $\tan \delta$ | Max. dissipation factor at 100 Hz |
| ESR | Equivalent series resistance at 100 Hz (calculated from $\tan \delta_{max.}$ and C_R) |
| Z | Max. impedance at 10 kHz |

Note

- Unless otherwise specified, all electrical values in Table 3 apply at $T_{amb} = 20 \text{ °C}$, $P = 86 \text{ kPa}$ to 106 kPa , $RH = 45 \text{ %}$ to 75 % .

ORDERING EXAMPLE

Electrolytic capacitor 119 series

 470 $\mu\text{F}/16 \text{ V}$; - 10 %/+ 50 %

 Nominal case size: $\varnothing 12.5 \text{ mm} \times 30 \text{ mm}$; form BR

Ordering code: MAL211925471E3

Former 12NC: 2222 119 25471



Table 3

| ELECTRICAL DATA AND ORDERING INFORMATION | | | | | | | | | | | | | |
|------------------------------------------|----------------------------------|-----------------------------------------|--------------|--------------------------------------------|----------------------------------|----------------------------------|-----------------|----------------------|--------------------|----------------------------|-----------------------------|----------------------------|-----------------------------|
| U _R (V) | C _R 100 Hz (µF) | NOMINAL CASE SIZE Ø D x L (mm) | CASE CODE | I _R 100 Hz 125 °C (mA) | I _{L1} 1 min (µA) | I _{L5} 5 min (µA) | tan δ 100 Hz | ESR 100 Hz (Ω) | Z 10 kHz (Ω) | ORDERING CODE MAL2119..... | | | |
| | | | | | | | | | | IN BOX FORM AA | TAPED ON REEL FORM BR | TAPED IN BOX FORM BA | MOUNTING RING FORM MR |
| 10 | 100 | 6.5 x 18 | 4 | 130 | 10 | 6 | 0.20 | 3.50 | 2.20 | - | 24101E3 | 34101E3 | - |
| | 220 | 10 x 18 | 6 | 240 | 17 | 8.4 | 0.18 | 1.30 | 1.00 | - | 24221E3 | 34221E3 | - |
| | 470 | 10 x 25 | 7 | 380 | 32 | 13 | 0.18 | 0.61 | 0.49 | - | 90501E3 | 90502E3 | - |
| | 470 | 12.5 x 30 | 01 | 550 | 32 | 13 | 0.16 | 0.54 | 0.38 | 14471E3 | 24471E3 | - | - |
| | 680 | 12.5 x 30 | 01 | 640 | 45 | 18 | 0.20 | 0.47 | 0.38 | 14681E3 | 24681E3 | - | - |
| | 1000 | 15 x 30 | 02 | 830 | 64 | 24 | 0.20 | 0.32 | 0.24 | 14102E3 | 24102E3 | - | 44102E3 |
| | 1500 | 18 x 30 | 03 | 1100 | 94 | 34 | 0.22 | 0.23 | 0.17 | 14152E3 | - | - | 44152E3 |
| | 2200 | 18 x 30 | 03 | 1190 | 136 | 48 | 0.26 | 0.19 | 0.17 | 14222E3 | - | - | 44222E3 |
| | 3300 | 18 x 38 | 04 | 1550 | 202 | 70 | 0.27 | 0.13 | 0.10 | 14332E3 | - | - | 44332E3 |
| 4700 | 21 x 38 | 05 | 1700 | 286 | 90 | 0.30 | 0.10 | 0.09 | 14472E3 | - | - | 44472E3 | |
| 16 | 47 | 6.5 x 18 | 4 | 110 | 10 | 5.5 | 0.13 | 4.40 | 2.20 | - | 25479E3 | 35479E3 | - |
| | 100 | 8 x 18 | 5 | 170 | 14 | 7.2 | 0.13 | 2.10 | 1.30 | - | 25101E3 | 35101E3 | - |
| | 220 | 10 x 25 | 7 | 300 | 25 | 11 | 0.13 | 0.94 | 0.55 | - | 25221E3 | 35221E3 | - |
| | 330 | 12.5 x 30 | 01 | 560 | 36 | 15 | 0.13 | 0.63 | 0.38 | 15331E3 | 25331E3 | - | - |
| | 470 | 12.5 x 30 | 01 | 570 | 50 | 19 | 0.15 | 0.51 | 0.38 | 15471E3 | 25471E3 | - | - |
| | 680 | 15 x 30 | 02 | 750 | 69 | 26 | 0.15 | 0.35 | 0.24 | 15681E3 | 25681E3 | - | 45681E3 |
| | 1000 | 15 x 30 | 02 | 850 | 100 | 36 | 0.19 | 0.30 | 0.24 | 15102E3 | 25102E3 | - | 45102E3 |
| | 1500 | 18 x 30 | 03 | 1120 | 148 | 52 | 0.20 | 0.21 | 0.17 | 15152E3 | - | - | 45152E3 |
| | 2200 | 18 x 38 | 04 | 1440 | 215 | 74 | 0.20 | 0.14 | 0.10 | 15222E3 | - | - | 45222E3 |
| 3300 | 21 x 38 | 05 | 1650 | 321 | 110 | 0.22 | 0.11 | 0.09 | 15332E3 | - | - | 45332E3 | |
| 4700 | 21 x 38 | 05 | 1710 | 455 | 154 | 0.28 | 0.09 | 0.09 | 15472E3 | - | - | 45472E3 | |
| 25 | 22 | 6.5 x 18 | 4 | 85 | 10 | 5.1 | 0.10 | 7.20 | 3.20 | - | 26229E3 | 36229E3 | - |
| | 100 | 10 x 18 | 6 | 210 | 19 | 9 | 0.10 | 1.60 | 1.00 | - | 26101E3 | 36101E3 | - |
| | 220 | 10 x 25 | 7 | 350 | 37 | 15 | 0.10 | 0.72 | 0.58 | - | 90503E3 | 90504E3 | - |
| | 220 | 12.5 x 30 | 01 | 500 | 37 | 15 | 0.09 | 0.65 | 0.38 | 16221E3 | 26221E3 | - | - |
| | 330 | 12.5 x 30 | 01 | 580 | 54 | 21 | 0.11 | 0.53 | 0.38 | 16331E3 | 26331E3 | - | - |
| | 470 | 12.5 x 30 | 01 | 630 | 75 | 28 | 0.13 | 0.44 | 0.38 | 16471E3 | 26471E3 | - | - |
| | 680 | 18 x 30 | 03 | 990 | 106 | 38 | 0.13 | 0.30 | 0.17 | 16681E3 | - | - | 46681E3 |
| | 1000 | 18 x 30 | 03 | 1090 | 154 | 54 | 0.13 | 0.21 | 0.17 | 16102E3 | - | - | 46102E3 |
| | 1500 | 18 x 38 | 04 | 1420 | 229 | 79 | 0.13 | 0.14 | 0.10 | 16152E3 | - | - | 46152E3 |
| 2200 | 21 x 38 | 05 | 1550 | 334 | 114 | 0.13 | 0.11 | 0.09 | 16222E3 | - | - | 46222E3 | |
| 40 | 47 | 8 x 18 | 5 | 150 | 15 | 7.8 | 0.08 | 2.70 | 1.50 | - | 27479E3 | 37479E3 | - |
| | 100 | 10 x 25 | 7 | 260 | 28 | 12 | 0.08 | 1.30 | 0.70 | - | 27101E3 | 37101E3 | - |
| | 150 | 12.5 x 30 | 01 | 440 | 40 | 16 | 0.08 | 0.85 | 0.51 | 17151E3 | 27151E3 | - | - |
| | 220 | 12.5 x 30 | 01 | 500 | 57 | 22 | 0.09 | 0.65 | 0.48 | 17221E3 | 27221E3 | - | - |
| | 330 | 15 x 30 | 02 | 630 | 83 | 30 | 0.09 | 0.43 | 0.37 | 17331E3 | 27331E3 | - | 47331E3 |
| | 470 | 15 x 30 | 02 | 720 | 117 | 42 | 0.12 | 0.41 | 0.37 | 17471E3 | 27471E3 | - | 47471E3 |
| | 680 | 18 x 30 | 03 | 970 | 167 | 58 | 0.12 | 0.28 | 0.22 | 17681E3 | - | - | 47681E3 |
| | 1000 | 18 x 38 | 04 | 1250 | 244 | 84 | 0.12 | 0.19 | 0.14 | 17102E3 | - | - | 47102E3 |
| | 1500 | 21 x 38 | 05 | 1410 | 364 | 124 | 0.14 | 0.15 | 0.12 | 17152E3 | - | - | 47152E3 |
| 2200 | 21 x 38 | 05 | 1550 | 532 | 180 | 0.18 | 0.13 | 0.11 | 17222E3 | - | - | 47222E3 | |



| ELECTRICAL DATA AND ORDERING INFORMATION | | | | | | | | | | | | | |
|------------------------------------------|----------------------------|--------------------------------|-----------|-----------------------------------|----------------------------|----------------------------|--------------|----------------|--------------|----------------------------|-----------------------|----------------------|-----------------------|
| U _R (V) | C _R 100 Hz (µF) | NOMINAL CASE SIZE Ø D x L (mm) | CASE CODE | I _R 100 Hz 125 °C (mA) | I _{L1} 1 min (µA) | I _{L5} 5 min (µA) | tan δ 100 Hz | ESR 100 Hz (Ω) | Z 10 kHz (Ω) | ORDERING CODE MAL2119..... | | | |
| | | | | | | | | | | IN BOX FORM AA | TAPED ON REEL FORM BR | TAPED IN BOX FORM BA | MOUNTING RING FORM MR |
| 63 | 10 | 6.5 x 18 | 4 | 68 | 20 | 5.3 | 0.07 | 11.0 | 5.60 | - | 28109E3 | 38109E3 | - |
| | 22 | 8 x 18 | 5 | 110 | 20 | 6.7 | 0.07 | 5.10 | 2.80 | - | 28229E3 | 38229E3 | - |
| | 47 | 10 x 18 | 6 | 180 | 22 | 9.9 | 0.07 | 2.40 | 1.30 | - | 28479E3 | 38479E3 | - |
| | 68 | 10 x 25 | 7 | 230 | 30 | 13 | 0.07 | 1.60 | 1.00 | - | 90505E3 | 90506E3 | - |
| | 68 | 10 x 30 | 00 | 300 | 30 | 13 | 0.07 | 1.60 | 0.92 | 18689E3 | 28689E3 | - | - |
| | 100 | 10 x 30 | 00 | 360 | 42 | 17 | 0.08 | 1.30 | 0.75 | 18101E3 | 28101E3 | - | - |
| | 150 | 15 x 30 | 02 | 560 | 61 | 23 | 0.08 | 0.85 | 0.37 | 18151E3 | 28151E3 | - | 48151E3 |
| | 220 | 15 x 30 | 02 | 640 | 87 | 32 | 0.08 | 0.58 | 0.37 | 18221E3 | 28221E3 | - | 48221E3 |
| | 330 | 18 x 30 | 03 | 880 | 129 | 46 | 0.09 | 0.43 | 0.23 | 18331E3 | - | - | 48331E3 |
| | 470 | 18 x 38 | 04 | 1130 | 182 | 63 | 0.09 | 0.30 | 0.15 | 18471E3 | - | - | 48471E3 |
| | 680 | 21 x 38 | 05 | 1290 | 261 | 90 | 0.09 | 0.21 | 0.12 | 18681E3 | - | - | 48681E3 |
| 1000 | 21 x 38 | 05 | 1430 | 382 | 130 | 0.10 | 0.16 | 0.11 | 18102E3 | - | - | 48102E3 | |
| 100 | 4.7 | 6.5 x 18 | 4 | 44 | 20 | 10 | 0.08 | 27.00 | 10.0 | - | 29478E3 | 39478E3 | - |
| | 10 | 8 x 18 | 5 | 70 | 20 | 10 | 0.08 | 13.00 | 6.00 | - | 29109E3 | 39109E3 | - |
| | 22 | 10 x 18 | 6 | 112 | 20 | 10 | 0.08 | 5.80 | 3.50 | - | 29229E3 | 39229E3 | - |
| | 47 | 10 x 25 | 7 | 178 | 32 | 13 | 0.08 | 2.70 | 2.00 | - | 90518E3 | 90519E3 | - |
| | 47 | 10 x 30 | 00 | 240 | 32 | 13 | 0.08 | 2.70 | 2.00 | 19479E3 | 29479E3 | - | - |
| | 68 | 12.5 x 30 | 01 | 330 | 45 | 18 | 0.08 | 1.90 | 1.20 | 19689E3 | 29689E3 | - | - |
| | 100 | 15 x 30 | 02 | 440 | 64 | 24 | 0.09 | 1.40 | 0.96 | 19101E3 | 29101E3 | - | 49101E3 |
| | 150 | 15 x 30 | 02 | 520 | 94 | 34 | 0.10 | 1.10 | 0.78 | 19151E3 | 29151E3 | - | 49151E3 |
| | 220 | 18 x 30 | 03 | 710 | 136 | 48 | 0.10 | 0.72 | 0.55 | 19221E3 | - | - | 49221E3 |
| | 330 | 18 x 38 | 04 | 920 | 202 | 70 | 0.10 | 0.48 | 0.37 | 19331E3 | - | - | 49331E3 |
| 470 | 21 x 38 | 05 | 1070 | 286 | 98 | 0.10 | 0.34 | 0.28 | 19471E3 | - | - | 49471E3 | |
| 200 | 4.7 | 10 x 18 | 6 | 52 | 20 | 10 | 0.08 | 27.0 | 10.0 | - | 90507E3 | 90508E3 | - |
| | 10 | 10 x 25 | 7 | 82 | 20 | 10 | 0.08 | 13.0 | 5.00 | - | 90509E3 | 90511E3 | - |

| ADDITIONAL ELECTRICAL DATA | | | |
|----------------------------|-----------------------------------------------------------------------|--------------------------------------------------------------------------------------------------------------------------------------------------------------------------------|---------------|
| PARAMETER | CONDITIONS | VALUE | |
| | | AXIAL | MOUNTING RING |
| Voltage | | | |
| Surge voltage | | $U_s \leq 1.15 \times U_R$ | |
| Reverse voltage | | $U_{rev} \leq 1 V$ | |
| Current | | | |
| Leakage current | After 1 min: $U_R = 10 V$ to $40 V$ $U_R = 63 V$ to $200 V$ | $I_{L1} \leq 0.006 C_R \times U_R + 4 \mu A$, or $10 \mu A$ (whichever is greater) $I_{L1} \leq 0.006 C_R \times U_R + 4 \mu A$, or $20 \mu A$ (whichever is greater) | |
| | After 5 min: $U_R = 10 V$ to $63 V$ $U_R = 100 V$ and $200 V$ | $I_{L5} \leq 0.002 C_R \times U_R + 4 \mu A$ $I_{L5} \leq 0.002 C_R \times U_R + 4 \mu A$, or $10 \mu A$ (whichever is greater) | |

| ADDITIONAL ELECTRICAL DATA | | | |
|------------------------------------|------------------|------------|---------------|
| PARAMETER | CONDITIONS | VALUE | |
| | | AXIAL | MOUNTING RING |
| Inductance | | | |
| Equivalent series inductance (ESL) | Case Ø D x L mm: | | |
| | 6.5 x 18 | Typ. 15 nH | - |
| | 8 x 18 | Typ. 35 nH | - |
| | 10 x 18 | Typ. 69 nH | - |
| | 10 x 25 | Typ. 38 nH | - |
| | 10 x 30 | Typ. 38 nH | - |
| | 12.5 x 30 | Typ. 46 nH | - |
| | 15 x 30 | Typ. 48 nH | Typ. 39 nH |
| | 18 x 30 | Typ. 50 nH | Typ. 39 nH |
| | 18 x 38 | Typ. 54 nH | Typ. 39 nH |
| 21 x 38 | Typ. 59 nH | Typ. 39 nH | |

Table 4

| UPRATING VALUES AT REDUCED AMBIENT TEMPERATURE | | | | | | | | | |
|------------------------------------------------|-------------------------------------------------------|--------|----|----|----|-----|-----|-----|------|
| SYMBOL | CONDITIONS | VALUES | | | | | | | UNIT |
| U_R | $T_{amb} > 85 \text{ to } 125 \text{ }^\circ\text{C}$ | 10 | 16 | 25 | 40 | 63 | 100 | 200 | V |
| U_{R2} | $T_{amb} \leq 85 \text{ }^\circ\text{C}$ | 16 | 25 | 40 | 63 | 100 | 125 | 250 | |

Note

- For applications at ambient temperatures of $\leq 85 \text{ }^\circ\text{C}$, the rated voltage (U_R) may be raised to U_{R2} .

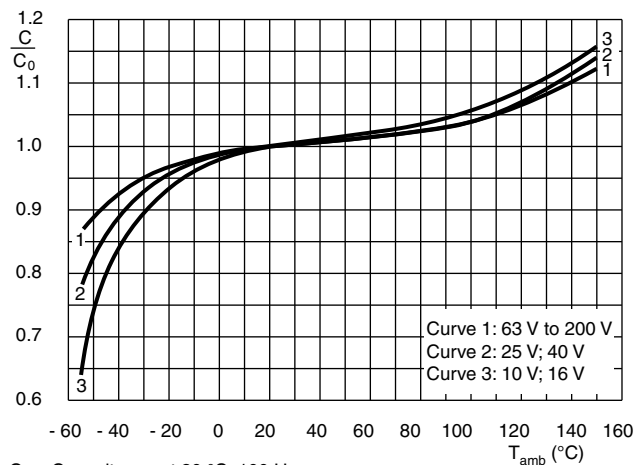
CAPACITANCE (C)


Fig. 5 - Typical multiplier of capacitance as a function of ambient temperature

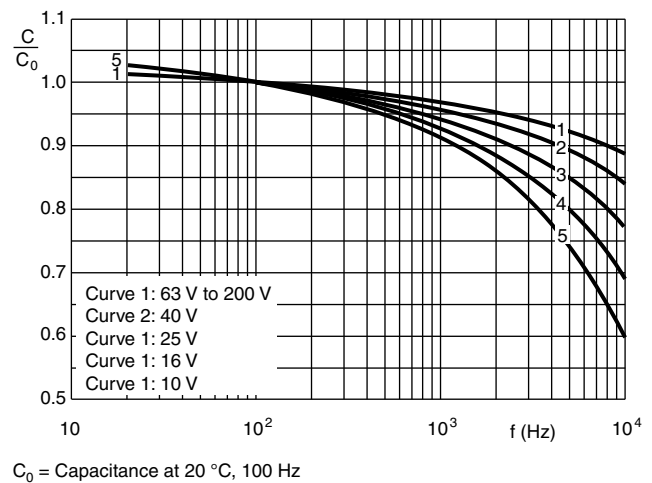
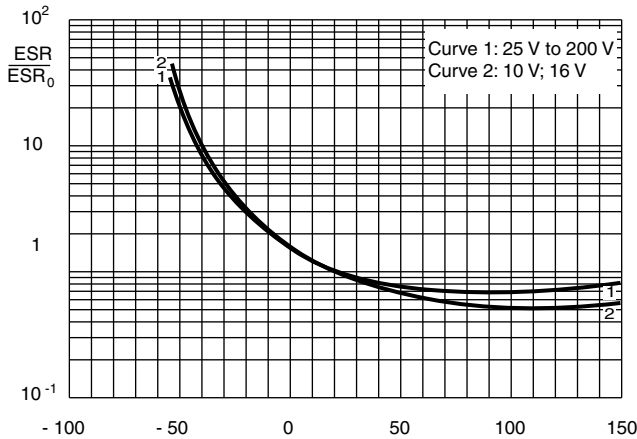


Fig. 6 - Typical multiplier of capacitance as a function of ambient temperature

EQUIVALENT SERIES RESISTANCE (ESR)



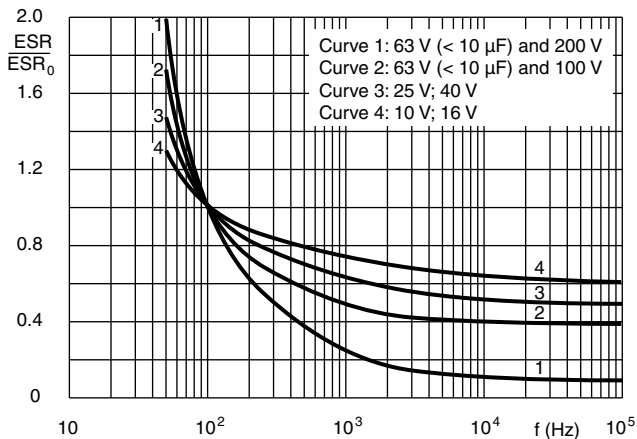
Case $\varnothing D \times L = 6.5 \text{ mm} \times 18 \text{ mm}$ to $15 \text{ mm} \times 30 \text{ mm}$
ESR₀ = Typical at 20 °C, 100 Hz

Fig. 7 - Typical multiplier of ESR as a function of ambient temperature



Case $\varnothing D \times L = 18 \text{ mm} \times 30 \text{ mm}$ to $21 \text{ mm} \times 38 \text{ mm}$
ESR₀ = Typical at 20 °C, 100 Hz

Fig. 8 - Typical multiplier of ESR as a function of ambient temperature



Case $\varnothing D \times L = 6.5 \text{ mm} \times 18 \text{ mm}$ to $10 \text{ mm} \times 25 \text{ mm}$
ESR₀ = Typical at 20 °C, 100 Hz

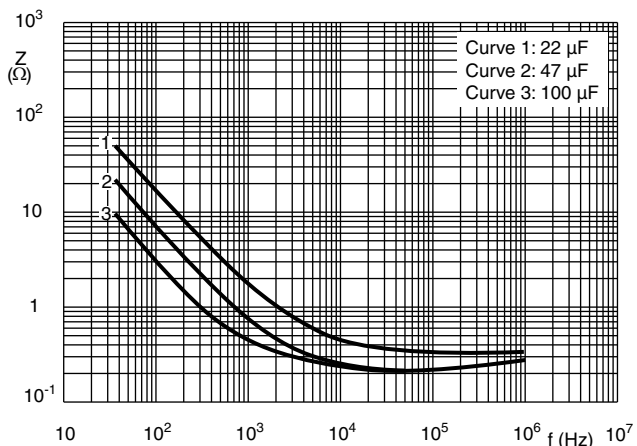
Fig. 9 - Typical multiplier of ESR as a function of frequency



Case $\varnothing D \times L = 10 \text{ mm} \times 30 \text{ mm}$ to $21 \text{ mm} \times 38 \text{ mm}$
ESR₀ = Typical at 20 °C, 100 Hz

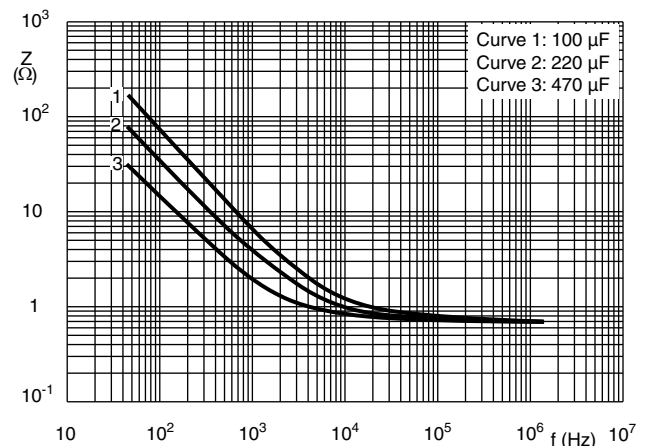
Fig. 10 - Typical multiplier of ESR as a function of frequency

IMPEDANCE (Z)



Case $\varnothing D \times L = 8 \text{ mm} \times 18 \text{ mm}$

Fig. 11 - Typical impedance as a function of frequency



Case $\varnothing D \times L = 8 \text{ mm} \times 18 \text{ mm}$

Fig. 12 - Typical impedance as a function of frequency T_{amb} (°C)

IMPEDANCE (Z)

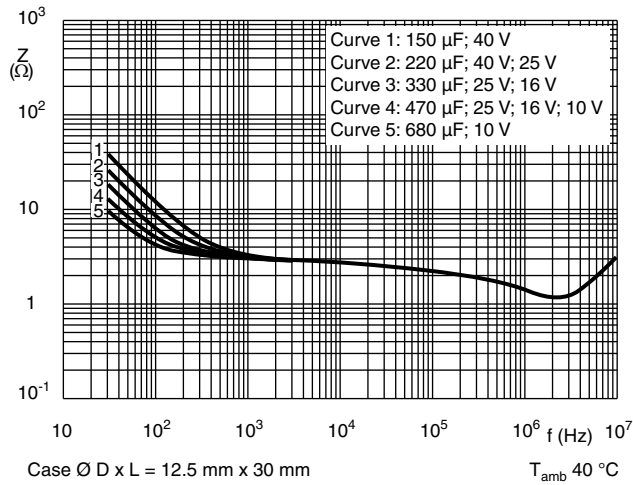


Fig. 13 - Typical impedance as a function of frequency

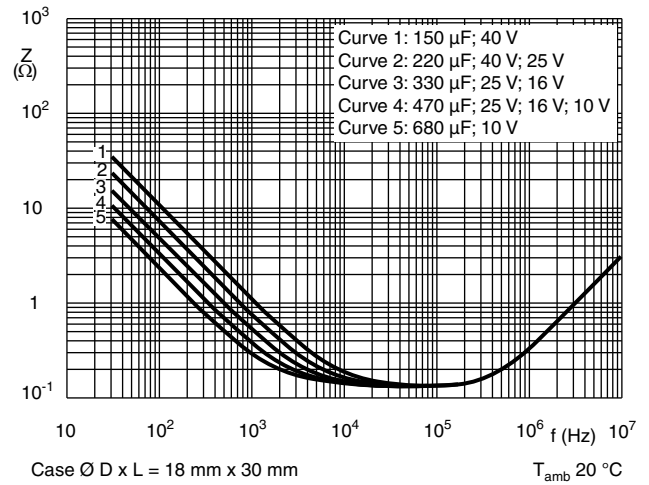


Fig. 14 - Typical impedance as a function of frequency

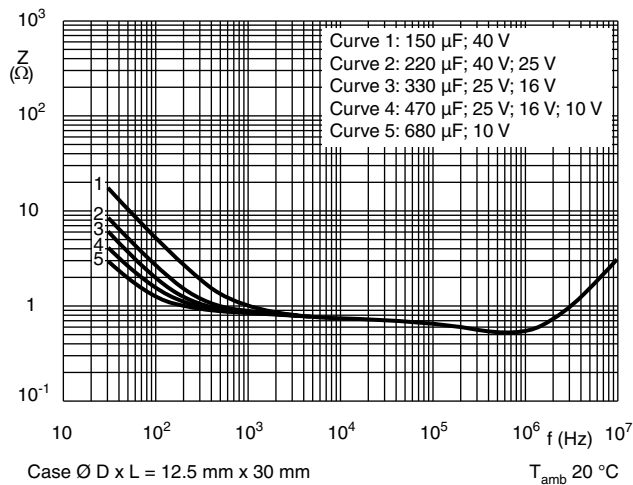


Fig. 15 - Typical impedance as a function of frequency

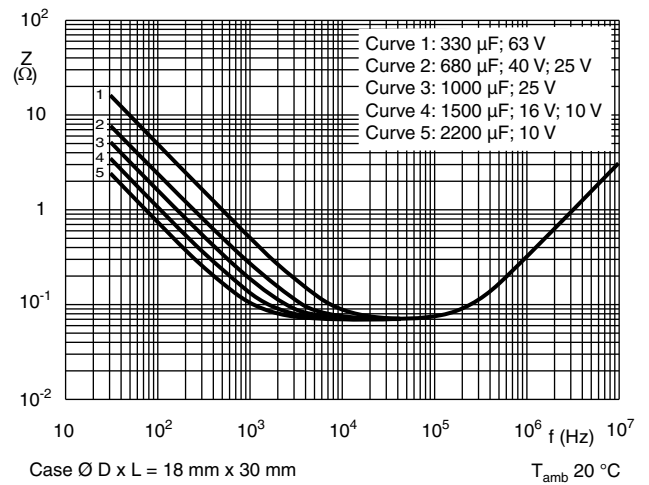


Fig. 16 - Typical impedance as a function of frequency

RIPPLE CURRENT AND USEFUL LIFE

MBC242

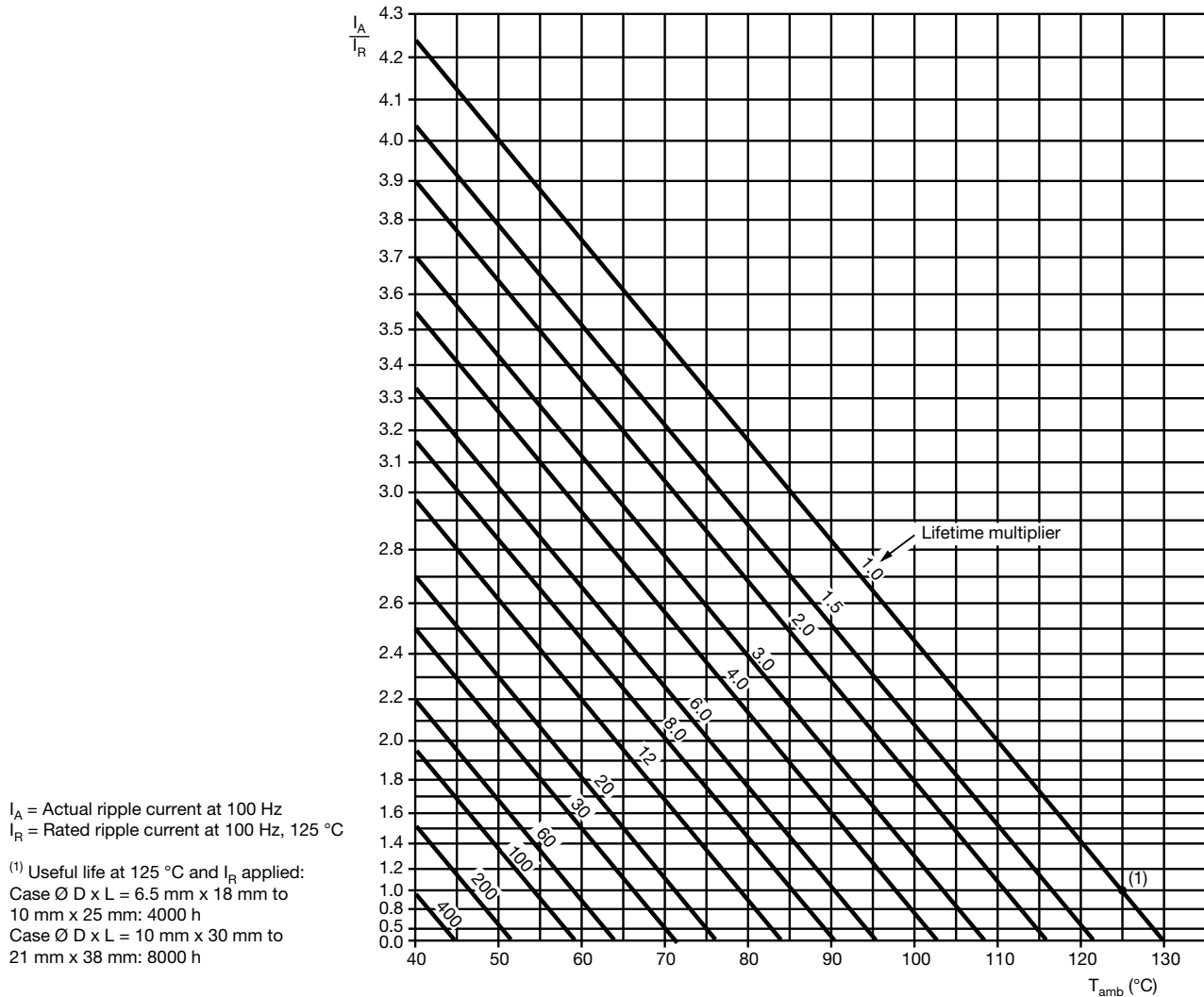


Fig. 17 - Multiplier of useful life as a function of ambient temperature and ripple current load

Table 5

| MULTIPLIER OF RIPPLE CURRENT (I_R) AS A FUNCTION OF FREQUENCY | | | |
|-------------------------------------------------------------------|-------------------------------------|-------------------------------------|-------------------------------------|
| FREQUENCY (Hz) | I_R MULTIPLIER | | |
| | $U_R = 10\text{ V AND }16\text{ V}$ | $U_R = 25\text{ V AND }40\text{ V}$ | $U_R = 63\text{ V TO }200\text{ V}$ |
| 50 | 0.95 | 0.90 | 0.85 |
| 100 | 1.00 | 1.00 | 1.00 |
| 300 | 1.07 | 1.12 | 1.20 |
| 1000 | 1.12 | 1.20 | 1.30 |
| 3000 | 1.15 | 1.25 | 1.35 |
| $\geq 10\ 000$ | 1.20 | 1.30 | 1.40 |

Table 6

| TEST PROCEDURES AND REQUIREMENTS | | | |
|------------------------------------------------|---------------------------------------------|----------------------------------------------------------------------------------------------------------------------------------------------------------------------------------------------------------------------------------------------------------------------|---------------------------------------------------------------------------------------------------------------------------------------------------------------------------------------------------------------------------------------------------------|
| TEST | | PROCEDURE (quick reference) | REQUIREMENTS |
| NAME OF TEST | REFERENCE | | |
| Endurance | IEC 60384-4/ EN 130300 subclause 4.13 | $T_{amb} = 125\text{ }^{\circ}\text{C}$; U_R applied; Case $\varnothing D \times L = 6.5\text{ mm} \times 18\text{ mm}$ to 10 mm x 25 mm: 2000 h; Case $\varnothing D \times L = 10\text{ mm} \times 30\text{ mm}$ to 21 mm x 38 mm: 4000 h | $\Delta C/C: \pm 15\%$ $\tan \delta \leq 1.3 \times \text{spec. limit}$ $Z \leq 2 \times \text{spec. limit}$ $I_{L5} \leq \text{spec. limit}$ |
| Useful life | CECC 30301 subclause 1.8.1 | $T_{amb} = 125\text{ }^{\circ}\text{C}$; U_R and I_R applied; Case $\varnothing D \times L = 6.5\text{ mm} \times 18\text{ mm}$ to 10 mm x 25 mm: 4000 h; Case $\varnothing D \times L = 10\text{ mm} \times 30\text{ mm}$ to 21 mm x 38 mm: 8000 h | $\Delta C/C: \pm 45\%$ $\tan \delta \leq 3 \times \text{spec. limit}$ $Z \leq 3 \times \text{spec. limit}$ $I_{L5} \leq \text{spec. limit}$ no short or open circuit total failure percentage: $\leq 1\%$ ($200\text{ V} \leq 3\%$) |
| Shelf life (storage at high temperature) | IEC 60384-4/ EN 130300 subclause 4.17 | $T_{amb} = 125\text{ }^{\circ}\text{C}$; no voltage applied; $U_R = 10\text{ V}$ to 63 V: 500 h; $U_R = 100\text{ V}$ and 200 V: 100 h After test: U_R to be applied for 30 min, 24 h to 48 h before measurement | $\Delta C/C, \tan \delta, Z$: For requirements see "Endurance test" above $I_{L5} \leq 2 \times \text{spec. limit}$ |
| Reverse voltage | IEC 60384-4/ EN 130300 subclause 4.15 | $T_{amb} = 125\text{ }^{\circ}\text{C}$: 125 h at $U = -1\text{ V}$ followed by 125 h at U_R | $\Delta C/C: \pm 20\%$ $\tan \delta \leq \text{spec. limit}$ $I_{L5} \leq \text{spec. limit}$ |



Disclaimer

ALL PRODUCT, PRODUCT SPECIFICATIONS AND DATA ARE SUBJECT TO CHANGE WITHOUT NOTICE TO IMPROVE RELIABILITY, FUNCTION OR DESIGN OR OTHERWISE.

Vishay Intertechnology, Inc., its affiliates, agents, and employees, and all persons acting on its or their behalf (collectively, "Vishay"), disclaim any and all liability for any errors, inaccuracies or incompleteness contained in any datasheet or in any other disclosure relating to any product.

Vishay makes no warranty, representation or guarantee regarding the suitability of the products for any particular purpose or the continuing production of any product. To the maximum extent permitted by applicable law, Vishay disclaims (i) any and all liability arising out of the application or use of any product, (ii) any and all liability, including without limitation special, consequential or incidental damages, and (iii) any and all implied warranties, including warranties of fitness for particular purpose, non-infringement and merchantability.

Statements regarding the suitability of products for certain types of applications are based on Vishay's knowledge of typical requirements that are often placed on Vishay products in generic applications. Such statements are not binding statements about the suitability of products for a particular application. It is the customer's responsibility to validate that a particular product with the properties described in the product specification is suitable for use in a particular application. Parameters provided in datasheets and/or specifications may vary in different applications and performance may vary over time. All operating parameters, including typical parameters, must be validated for each customer application by the customer's technical experts. Product specifications do not expand or otherwise modify Vishay's terms and conditions of purchase, including but not limited to the warranty expressed therein.

Except as expressly indicated in writing, Vishay products are not designed for use in medical, life-saving, or life-sustaining applications or for any other application in which the failure of the Vishay product could result in personal injury or death. Customers using or selling Vishay products not expressly indicated for use in such applications do so at their own risk. Please contact authorized Vishay personnel to obtain written terms and conditions regarding products designed for such applications.

No license, express or implied, by estoppel or otherwise, to any intellectual property rights is granted by this document or by any conduct of Vishay. Product names and markings noted herein may be trademarks of their respective owners.

Material Category Policy

Vishay Intertechnology, Inc. hereby certifies that all its products that are identified as RoHS-Compliant fulfill the definitions and restrictions defined under Directive 2011/65/EU of The European Parliament and of the Council of June 8, 2011 on the restriction of the use of certain hazardous substances in electrical and electronic equipment (EEE) - recast, unless otherwise specified as non-compliant.

Please note that some Vishay documentation may still make reference to RoHS Directive 2002/95/EC. We confirm that all the products identified as being compliant to Directive 2002/95/EC conform to Directive 2011/65/EU.

Vishay Intertechnology, Inc. hereby certifies that all its products that are identified as Halogen-Free follow Halogen-Free requirements as per JEDEC JS709A standards. Please note that some Vishay documentation may still make reference to the IEC 61249-2-21 definition. We confirm that all the products identified as being compliant to IEC 61249-2-21 conform to JEDEC JS709A standards.