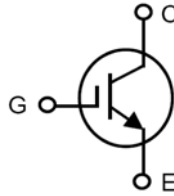

XPT™ 650V IGBT
GenX3™
IXYA20N65C3
IXYH20N65C3

 Extreme Light Punch Through
 IGBT for 20-60 kHz Switching

$$V_{CES} = 650V$$

$$I_{C110} = 20A$$

$$V_{CE(sat)} \leq 2.50V$$

$$t_{fi(typ)} = 28ns$$

| Symbol | Test Conditions | Maximum Ratings | |
|-------------------------------|---|--|------------|
| V_{CES} | $T_J = 25^\circ C$ to $175^\circ C$ | 650 | V |
| V_{CGR} | $T_J = 25^\circ C$ to $175^\circ C$, $R_{GE} = 1M\Omega$ | 650 | V |
| V_{GES} | Continuous | ± 20 | V |
| V_{GEM} | Transient | ± 30 | V |
| I_{C25} | $T_C = 25^\circ C$ | 50 | A |
| I_{C110} | $T_C = 110^\circ C$ | 20 | A |
| I_{CM} | $T_C = 25^\circ C$, 1ms | 105 | A |
| I_A | $T_C = 25^\circ C$ | 10 | A |
| E_{AS} | $T_C = 25^\circ C$ | 200 | mJ |
| SSOA (RBSOA) | $V_{GE} = 15V$, $T_{VJ} = 150^\circ C$, $R_G = 20\Omega$ Clamped Inductive Load | $I_{CM} = 40$ $V_{CE} \leq V_{CES}$ | A |
| t_{sc} (SCSOA) | $V_{GE} = 15V$, $V_{CE} = 360V$, $T_J = 150^\circ C$ $R_G = 82\Omega$, Non Repetitive | 10 | μs |
| P_C | $T_C = 25^\circ C$ | 230 | W |
| T_J | | -55 ... +175 | $^\circ C$ |
| T_{JM} | | 175 | $^\circ C$ |
| T_{stg} | | -55 ... +175 | $^\circ C$ |
| T_L | Maximum Lead Temperature for Soldering | 300 | $^\circ C$ |
| T_{SOLD} | 1.6 mm (0.062in.) from Case for 10s | 260 | $^\circ C$ |
| M_d | Mounting Torque | 1.13/10 | Nm/lb.in |
| Weight | TO-263 | 2.5 | g |
| | TO-247 | 6.0 | g |

| Symbol | Test Conditions ($T_J = 25^\circ C$, Unless Otherwise Specified) | Characteristic Values | | |
|---------------|---|-----------------------|--------------|---------------------------|
| | | Min. | Typ. | Max. |
| BV_{CES} | $I_C = 250\mu A$, $V_{GE} = 0V$ | 650 | | V |
| $V_{GE(th)}$ | $I_C = 250\mu A$, $V_{CE} = V_{GE}$ | 3.5 | | 6.0 V |
| I_{CES} | $V_{CE} = V_{CES}$, $V_{GE} = 0V$ $T_J = 150^\circ C$ | | | 10 μA 150 μA |
| I_{GES} | $V_{CE} = 0V$, $V_{GE} = \pm 20V$ | | | ± 100 nA |
| $V_{CE(sat)}$ | $I_C = 20A$, $V_{GE} = 15V$, Note 1 $T_J = 150^\circ C$ | | 2.27 2.44 | 2.50 V V |

TO-263 AA (IXYA)

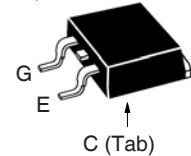

TO-247 AD

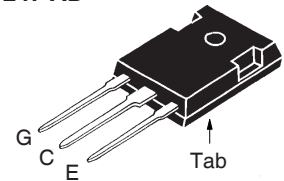

G = Gate C = Collector
 E = Emitter Tab = Collector

Features

- Optimized for 20-60kHz Switching
- Square RBSOA
- Avalanche Rated
- Short Circuit Capability
- International Standard Packages

Advantages

- High Power Density
- Extremely Rugged
- Low Gate Drive Requirement

Applications

- Power Inverters
- UPS
- Motor Drives
- SMPS
- PFC Circuits
- Battery Chargers
- Welding Machines
- Lamp Ballasts
- High Frequency Power Inverters

| Symbol Test Conditions ($T_J = 25^\circ\text{C}$ Unless Otherwise Specified) | | Characteristic Values | | |
|--|--|-----------------------|------|--------------------------------|
| | | Min. | Typ. | Max. |
| g_{fs} | $I_C = 20\text{A}, V_{CE} = 10\text{V}$, Note 1 | 7 | 12 | S |
| C_{ies} | $V_{CE} = 25\text{V}, V_{GE} = 0\text{V}, f = 1\text{MHz}$ | | 822 | pF |
| C_{oes} | | | 52 | pF |
| C_{res} | | | 19 | pF |
| $Q_{g(on)}$ | $I_C = 20\text{A}, V_{GE} = 15\text{V}, V_{CE} = 0.5 \cdot V_{CES}$ | | 30 | nC |
| Q_{ge} | | | 6 | nC |
| Q_{gc} | | | 15 | nC |
| $t_{d(on)}$ | Inductive load, $T_J = 25^\circ\text{C}$ $I_C = 20\text{A}, V_{GE} = 15\text{V}$ $V_{CE} = 400\text{V}, R_G = 20\Omega$ Note 2 | | 19 | ns |
| t_{ri} | | | 34 | ns |
| E_{on} | | | 0.43 | mJ |
| $t_{d(off)}$ | | | 80 | ns |
| t_{fi} | | | 28 | ns |
| E_{off} | | | 0.35 | 0.65 mJ |
| $t_{d(on)}$ | Inductive load, $T_J = 150^\circ\text{C}$ $I_C = 20\text{A}, V_{GE} = 15\text{V}$ $V_{CE} = 400\text{V}, R_G = 20\Omega$ Note 2 | | 18 | ns |
| t_{ri} | | | 33 | ns |
| E_{on} | | | 0.70 | mJ |
| $t_{d(off)}$ | | | 96 | ns |
| t_{fi} | | | 36 | ns |
| E_{off} | | | 0.40 | mJ |
| R_{thJC} | TO-247 | | | 0.65 $^\circ\text{C}/\text{W}$ |
| R_{thCS} | | | 0.21 | $^\circ\text{C}/\text{W}$ |

Notes:

1. Pulse test, $t \leq 300\mu\text{s}$, duty cycle, $d \leq 2\%$.
2. Switching times & energy losses may increase for higher V_{CE} (clamp), T_J or R_G .

PRELIMINARY TECHNICAL INFORMATION

The product presented herein is under development. The Technical Specifications offered are derived from a subjective evaluation of the design, based upon prior knowledge and experience, and constitute a "considered reflection" of the anticipated result. IXYS reserves the right to change limits, test conditions, and dimensions without notice.

TO-263 Outline

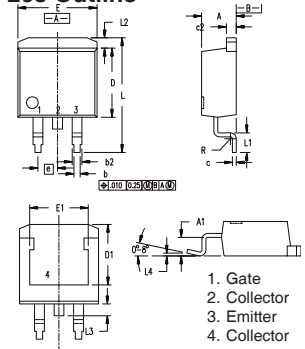

| Dim. | Millimeter | | Inches | |
|------|------------|-------|--------|------|
| | Min. | Max. | Min. | Max. |
| A | 4.06 | 4.83 | .160 | .190 |
| b | 0.51 | 0.99 | .020 | .039 |
| b2 | 1.14 | 1.40 | .045 | .055 |
| c | 0.40 | 0.74 | .016 | .029 |
| c2 | 1.14 | 1.40 | .045 | .055 |
| D | 8.64 | 9.65 | .340 | .380 |
| D1 | 8.00 | 8.89 | .280 | .320 |
| E | 9.65 | 10.41 | .380 | .405 |
| E1 | 6.22 | 8.13 | .270 | .320 |
| e | 2.54 | BSC | .100 | BSC |
| L | 14.61 | 15.88 | .575 | .625 |
| L1 | 2.29 | 2.79 | .090 | .110 |
| L2 | 1.02 | 1.40 | .040 | .055 |
| L3 | 1.27 | 1.78 | .050 | .070 |
| L4 | 0 | 0.13 | 0 | .005 |

TO-247 (IXYH) Outline

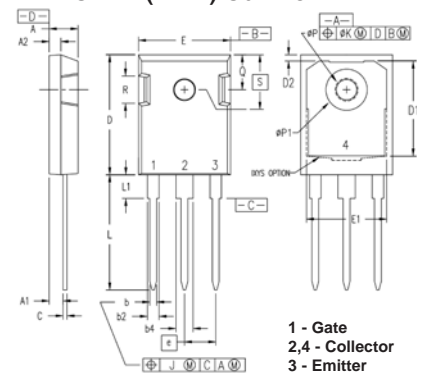

| Dim. | Millimeter | | Inches | |
|------|------------|-------|-----------|-------|
| | min | max | min | max |
| A | 4.70 | 5.30 | 0.185 | 0.209 |
| A1 | 2.21 | 2.59 | 0.087 | 0.102 |
| A2 | 1.50 | 2.49 | 0.059 | 0.098 |
| b | 0.99 | 1.40 | 0.039 | 0.055 |
| b2 | 1.65 | 2.39 | 0.065 | 0.094 |
| b4 | 2.59 | 3.43 | 0.102 | 0.135 |
| c | 0.38 | 0.89 | 0.015 | 0.035 |
| D | 20.79 | 21.45 | 0.819 | 0.845 |
| D1 | 13.07 | - | 0.515 | - |
| D2 | 0.51 | 1.35 | 0.020 | 0.053 |
| E | 15.48 | 16.24 | 0.610 | 0.640 |
| E1 | 13.45 | - | 0.53 | - |
| E2 | 4.31 | 5.48 | 0.170 | 0.216 |
| e | 5.45 BSC | | 0.215 BSC | |
| L | 19.80 | 20.30 | 0.078 | 0.800 |
| L1 | - | 4.49 | - | 0.177 |
| Ø P | 3.55 | 3.65 | 0.140 | 0.144 |
| Ø P1 | - | 7.39 | - | 0.290 |
| Q | 5.38 | 6.19 | 0.212 | 0.244 |
| S | 6.14 BSC | | 0.242 BSC | |

IXYS Reserves the Right to Change Limits, Test Conditions, and Dimensions.

| | | | | | | | | | | |
|--|-----------|-----------|-----------|-----------|--------------|--------------|--------------|--------------|--------------|-------------|
| IXYS MOSFETs and IGBTs are covered by one or more of the following U.S. patents: | 4,835,592 | 4,931,844 | 5,049,961 | 5,237,481 | 6,162,665 | 6,404,065 B1 | 6,683,344 | 6,727,585 | 7,005,734 B2 | 7,157,338B2 |
| | 4,860,072 | 5,017,508 | 5,063,307 | 5,381,025 | 6,259,123 B1 | 6,534,343 | 6,710,405 B2 | 6,759,692 | 7,063,975 B2 | |
| | 4,881,106 | 5,034,796 | 5,187,117 | 5,486,715 | 6,306,728 B1 | 6,583,505 | 6,710,463 | 6,771,478 B2 | 7,071,537 | |

Fig. 1. Output Characteristics @ $T_J = 25^\circ\text{C}$

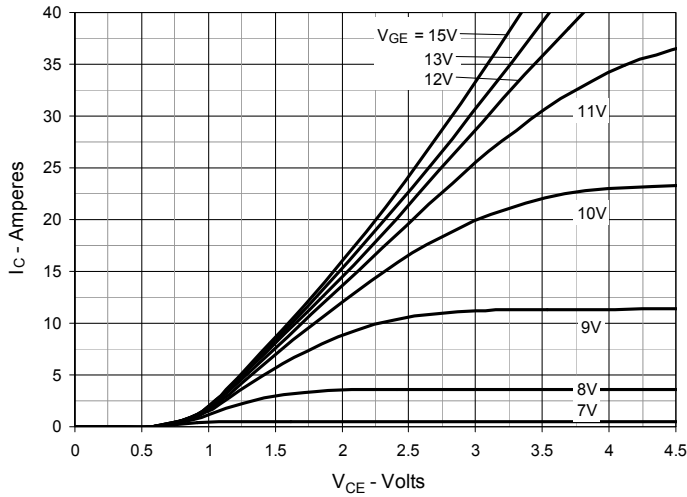

Fig. 2. Extended Output Characteristics @ $T_J = 25^\circ\text{C}$

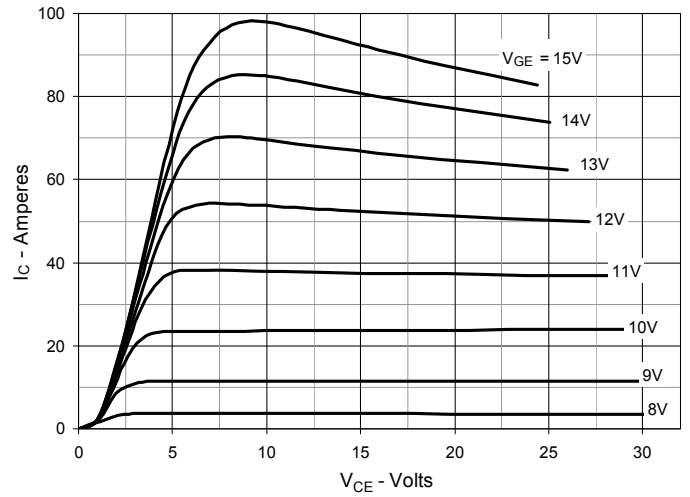

Fig. 3. Output Characteristics @ $T_J = 150^\circ\text{C}$

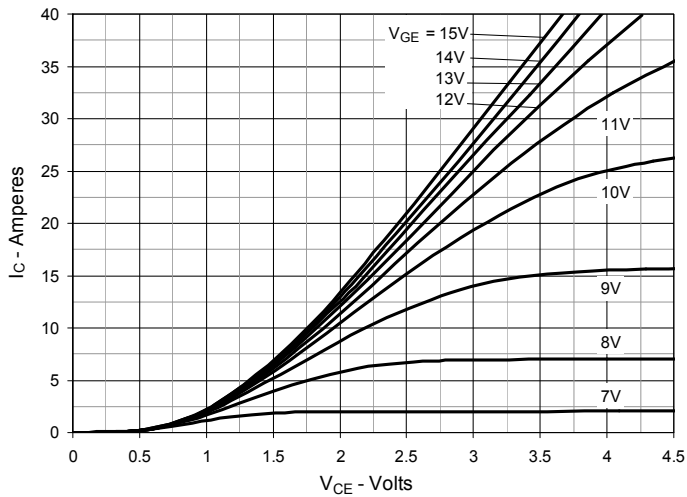

Fig. 4. Dependence of $V_{CE(sat)}$ on Junction Temperature

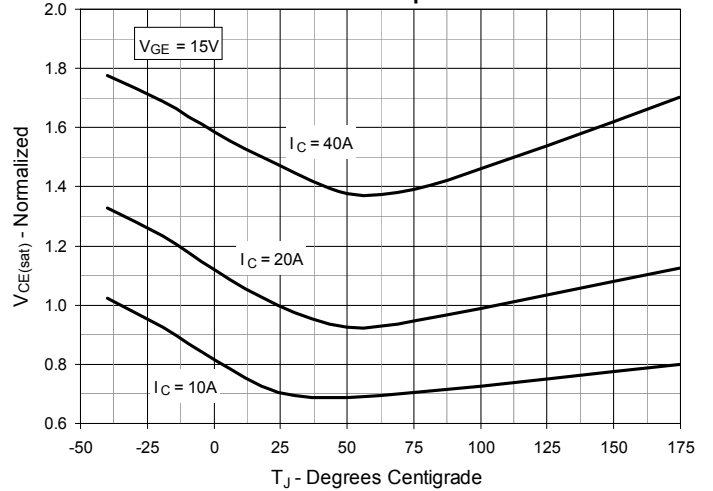

Fig. 5. Collector-to-Emitter Voltage vs. Gate-to-Emitter Voltage

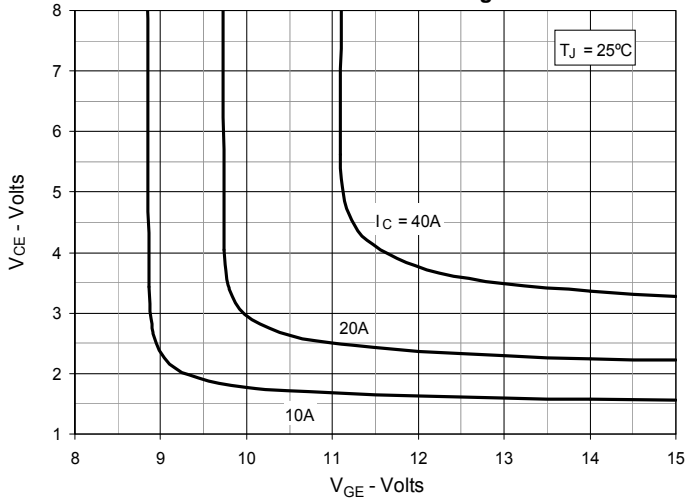

Fig. 6. Input Admittance

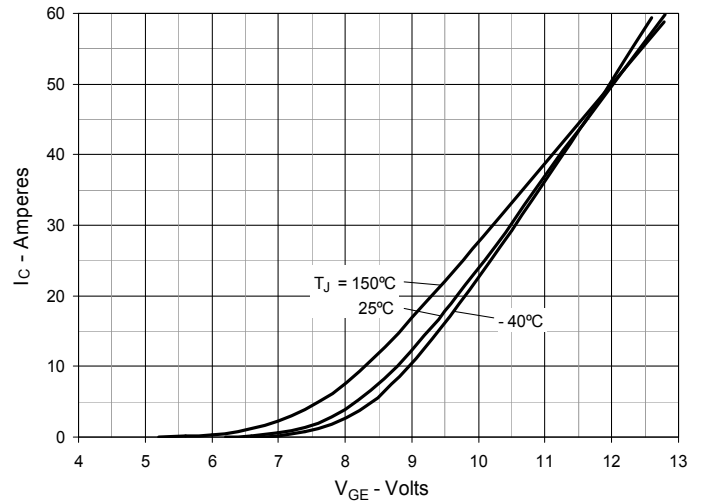

Fig. 7. Transconductance

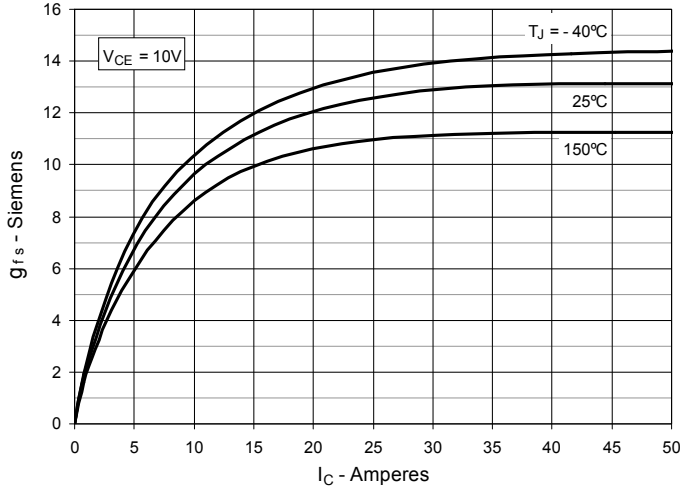

Fig. 8. Gate Charge

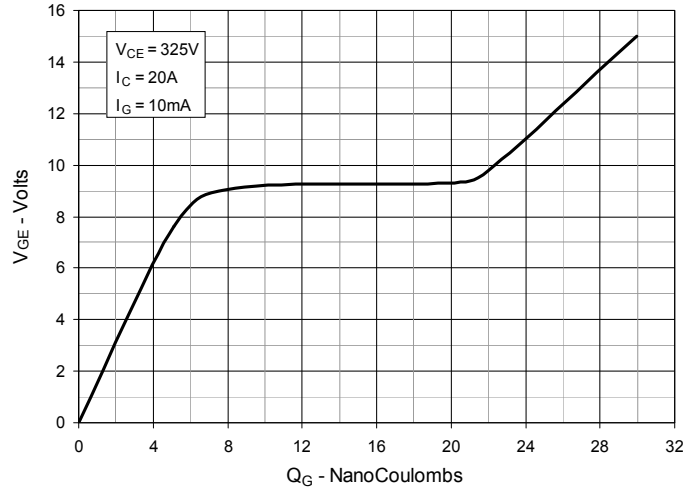

Fig. 9. Capacitance

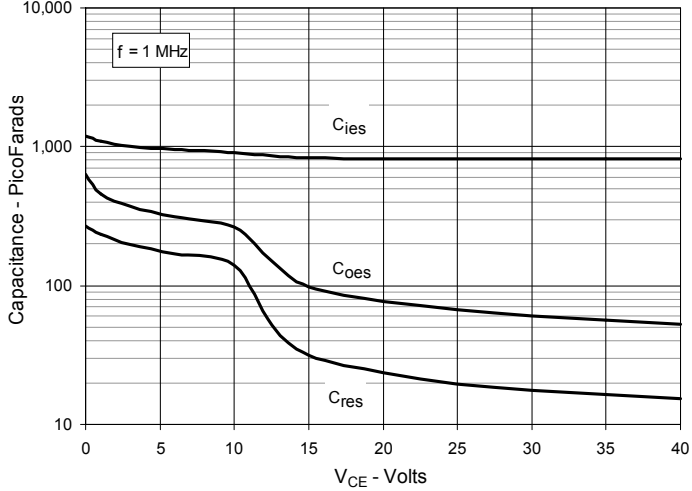

Fig. 10. Reverse-Bias Safe Operating Area

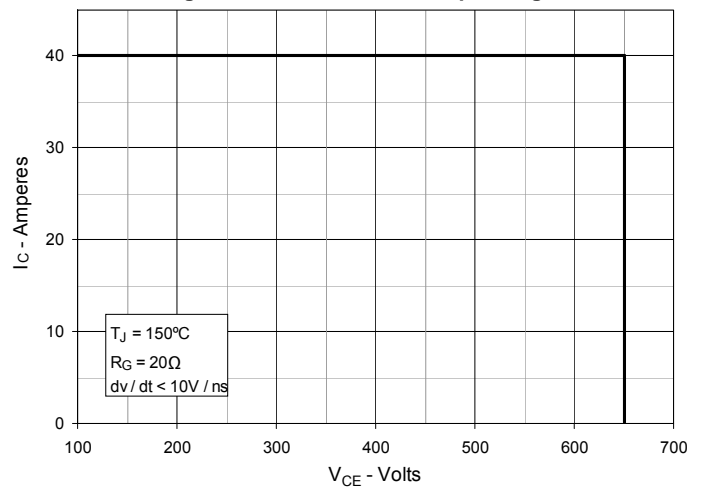

Fig. 11. Forward-Bias Safe Operating Area

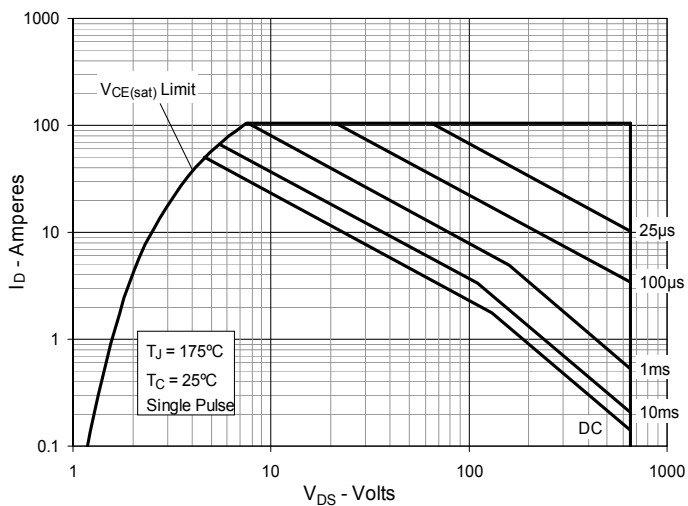

Fig. 12. Maximum Transient Thermal Impedance (IGBT)

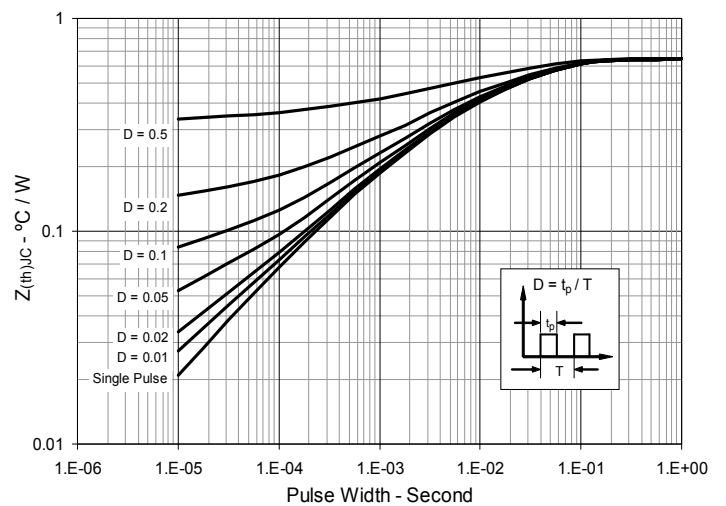

Fig. 13. Inductive Switching Energy Loss vs. Gate Resistance

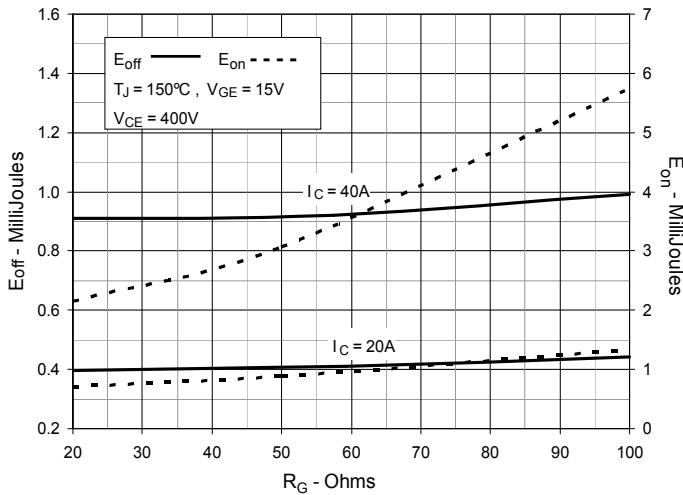

Fig. 14. Inductive Switching Energy Loss vs. Collector Current

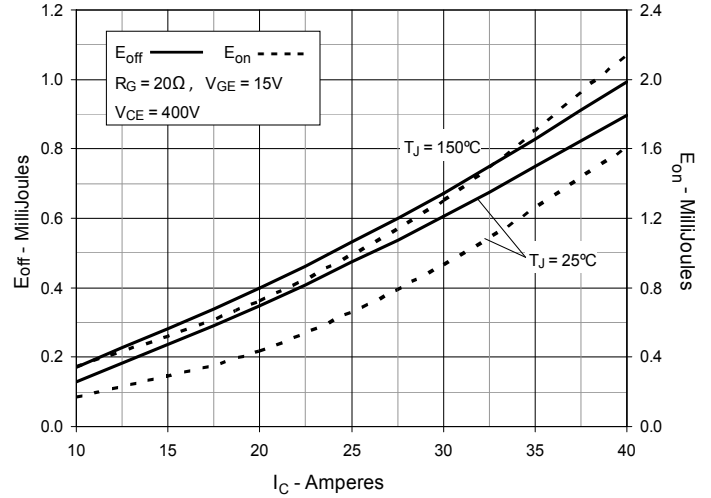

Fig. 15. Inductive Switching Energy Loss vs. Junction Temperature

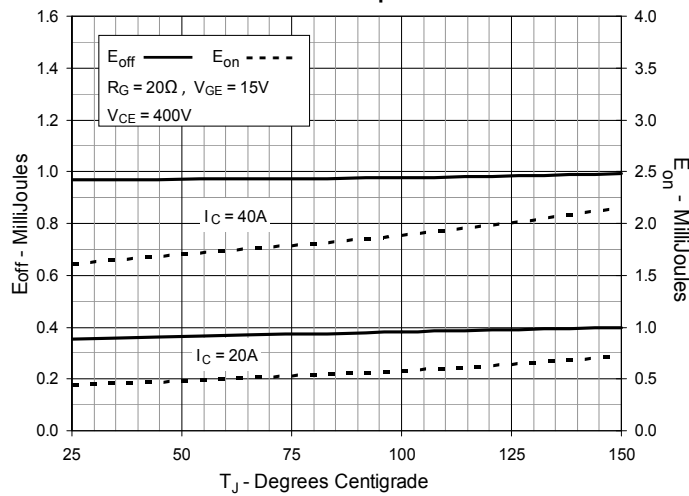

Fig. 16. Inductive Turn-off Switching Times vs. Gate Resistance

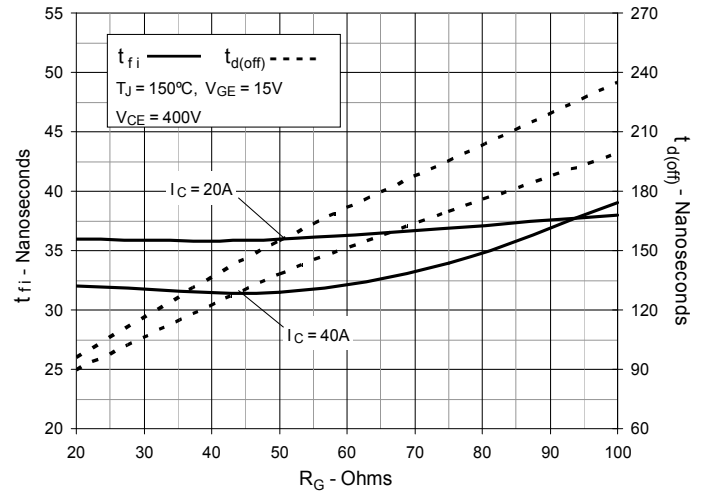

Fig. 17. Inductive Turn-off Switching Times vs. Collector Current

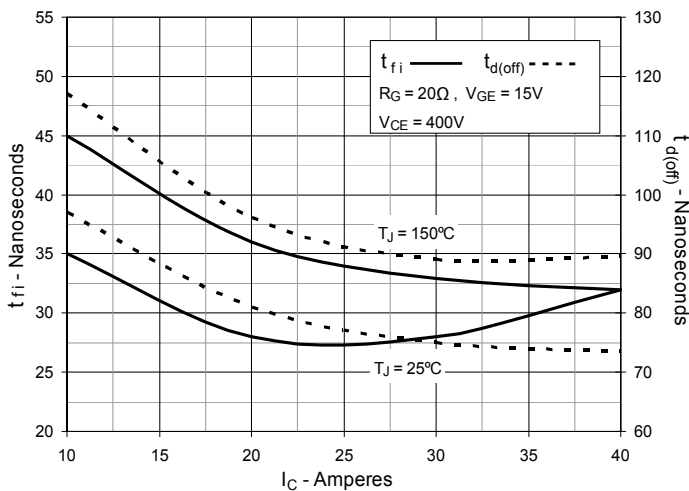

Fig. 18. Inductive Turn-off Switching Times vs. Junction Temperature

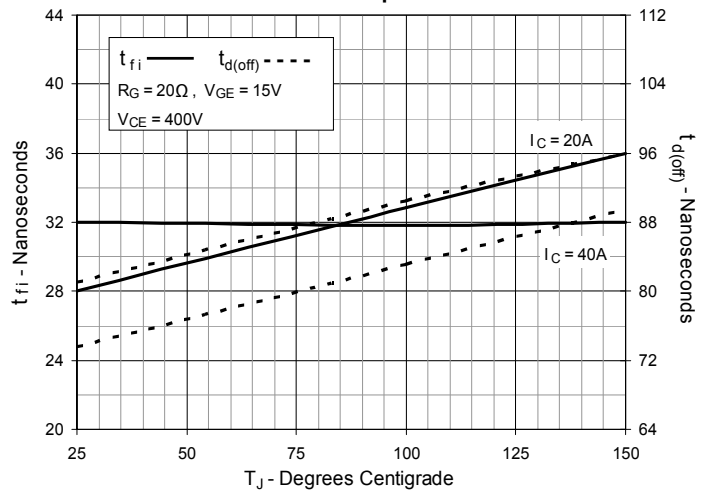

Fig. 19. Inductive Turn-on Switching Times vs. Gate Resistance



Fig. 20. Inductive Turn-on Switching Times vs. Collector Current

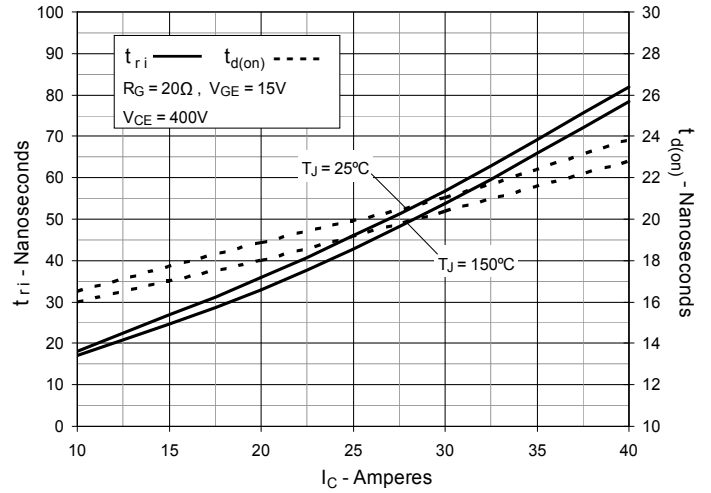

Fig. 21. Inductive Turn-on Switching Times vs. Junction Temperature

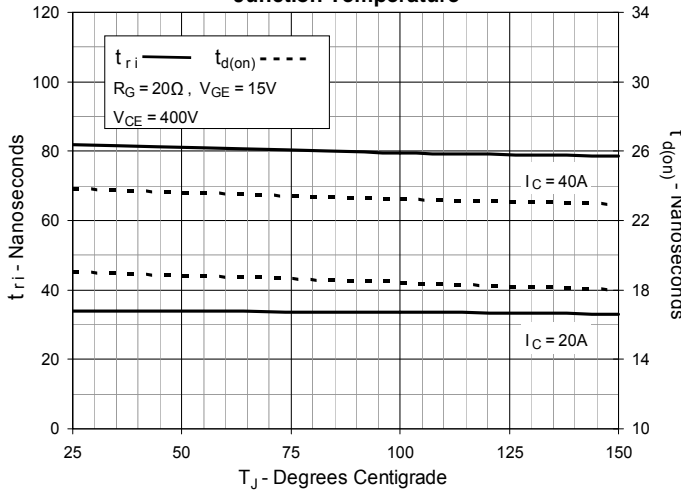
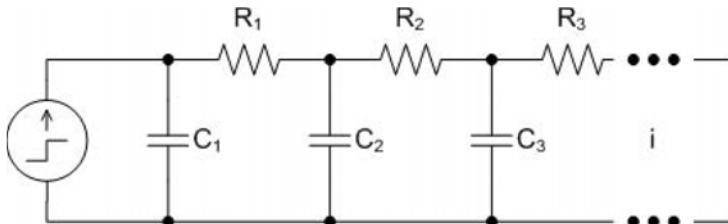

Fig. 22. Cauer Thermal Network



| i | Ri (°C/W) | Ci (J/°C) |
|---|-----------|-----------|
| 1 | 0.170320 | 0.0017715 |
| 2 | 0.136990 | 0.0166820 |
| 3 | 0.090011 | 0.0391660 |



Disclaimer Notice - Information furnished is believed to be accurate and reliable. However, users should independently evaluate the suitability of and test each product selected for their own applications. Littelfuse products are not designed for, and may not be used in, all applications. Read complete Disclaimer Notice at www.littelfuse.com/disclaimer-electronics.