

# 24CE/924CE

## Miniature Safety Electromechanical Switch

### FEATURES

- Positive opening operation of Normally Closed contacts conforming to IEC/EN 60947-5-1-3
- Compact construction
- Pre-wired
- Die-cast Zinc housing
- Wide selection of actuators
- Cable length variations
- Side and bottom exit cable
- Simple two-screw mounting
- IP 65/66/67
- UL recognised; CSA certified (924CE), CE compliant, BG approved (24CE)

### BENEFITS

- Suitable for applications where space is at a premium
- Fast and easy to install
- Suitable for difficult operating environments
- Application flexibility
- Enhanced choice for application
- Multiple plunger capability



(924CE Series Only)



(24CE Series Only)



The ranges 24CE and 924CE have been tested and approved to meet the requirements of the Low Voltage directive and positive opening safety contacts per IEC/EN 60947-5-1-3. The devices are CE marked. The red colour clearly differentiates this safety component in the application. The 924CE range also has UL and CSA approval.

It is possible for the end user to enhance the safety level of these switches from Category 1 per EN 954-1 on their own to Categories 2, 3 or 4 per EN 954-1 when the switches are used in conjunction with our wide range of FF-SR safety control modules to form a safety system.

Typical applications for these switches would use the roller plunger 24CE18 style in conjunction with cams on doors with hinges. Also available are a range of panel mounting or top mounting versions to ensure that small space or difficult mounting can be simply achieved.

Several contact arrangements are available.

24CE/924CE

### WARNING

#### MISUSE OF DOCUMENTATION

- The information presented in this product sheet (or catalogue) is for reference only. DO NOT USE this document as system installation information.
- Complete installation, operation and maintenance information is provided in the instructions supplied with each product.

Failure to comply with these instructions could result in death or serious injury.

## 24CE Series

### Miniature Safety Electromechanical Switch

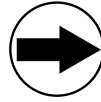

#### Technical Data

<b>Mechanical life</b>	10 million operations.
<b>Degree of protection</b>	24CE Standard type: IP 66 With boot seal type: IP 67
<b>Temperature range</b>	<i>Operating:</i> 0 °C to +70 °C / 32 °F to +160 °F
<b>Approvals*</b>	IEC 60947-5-1 EN 60947-5-1 ac15 B300 dc13 R300
<b>Electrical</b>	According to IEC/EN 60947-5-1. Rated insulation voltage $U_i = 500$ V. Rated impulse withstand voltage $U_{imp} = 2,5$ kV. Not suitable for isolation. SCPD, Quick blow fuse to IEC 127 suitable for rated current.

\* See Standards (page 179)

Dimensions in mm / in

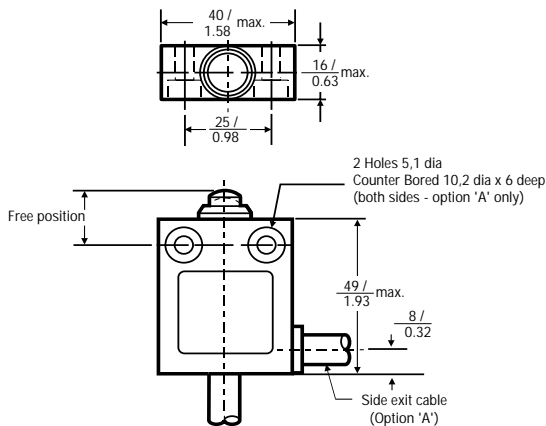

**Cable Type**  
3 or 5 x 0,75 mm<sup>2</sup> harmonised CENELEC cable.

Ordering:

**24CE**

Example: 24CE18-Y1A

#### Actuator Types

#### Slow Action Contacts 1 Normally Closed

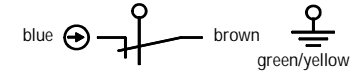

■ Circuit closed  
\* Positive opening to IEC/EN 60947-5-1-3

	<p>17,1 +/- 0,4 O.P. 13,1 * P.T = 2,2 max. O.F (max.) = 22,5 Newtons / 2300 GMF</p>
	<p>29,9 +/- 0,4 O.P. 25,9 * P.T = 2,2 max. O.F (max.) = 22,5 Newtons / 2300 GMF</p>
	<p>29,9 +/- 0,4 O.P. 25,9 * P.T = 2,2 max. O.F (max.) = 22,5 Newtons / 2300 GMF</p>
	<p>0 Degrees O.P. 50 Deg. * P.T = 30 Degrees max. O.F (max.) = 7,85 Newtons / 800 GMF</p>
<p>ø7,1 24,3 max.</p> <p><b>18</b></p> <p>Pin Plunger (Boot Sealed)</p>	<p>23,9 +/- 0,4 O.P. 19,9 * P.T = 2,2 max. O.F (max.) = 22,5 Newtons / 2300 GMF</p>
<p>ø12,4 36,1 max.</p> <p><b>31</b></p> <p>Roller Plunger Parallel (Boot Sealed)</p>	<p>35,7 +/- 0,4 O.P. 31,7 * P.T = 2,2 max. O.F (max.) = 22,5 Newtons / 2300 GMF</p>
<p>ø12,4 36,1 max.</p> <p><b>55</b></p> <p>Roller Plunger Perpendicular (Boot Sealed)</p>	<p>35,7 +/- 0,4 O.P. 31,7 * P.T = 2,2 max. O.F (max.) = 22,5 Newtons / 2300 GMF</p>

**Y**

**X OR XX**

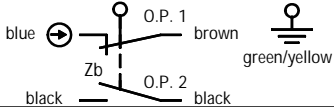
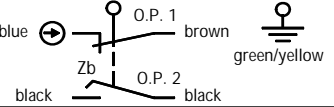
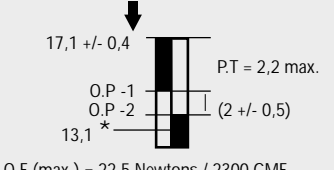
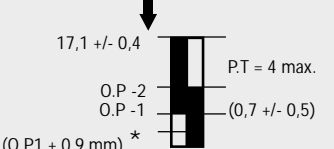
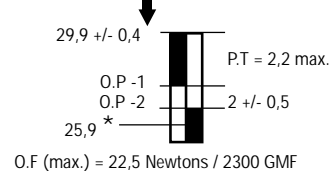
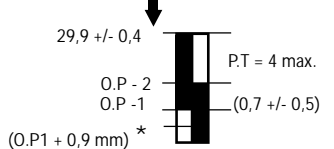
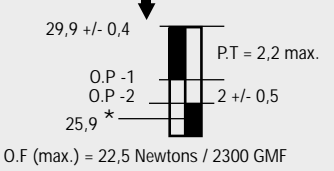
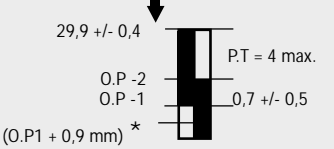
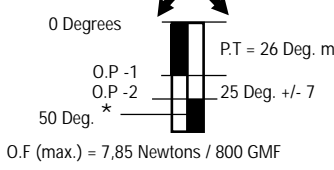
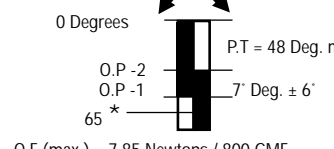
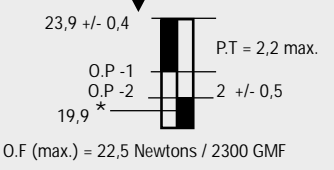
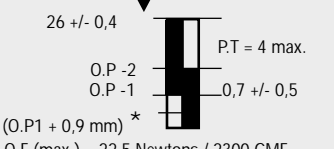
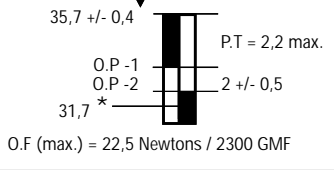
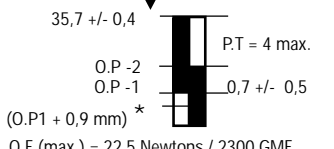
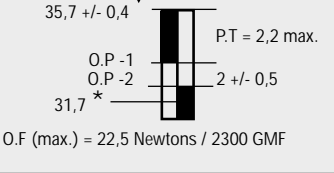
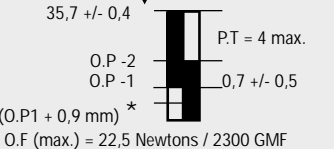
<p><b>Slow Action Contacts</b>  <b>1 Normally Closed/                      1 Normally Open</b>  <b>Break before make</b></p> 	<p><b>Slow Action Contacts</b>  <b>1 Normally Closed/                      1 Normally Open</b>  <b>Make before break</b></p> 	<p><b>Cable Length</b>                      (in metres)</p>	<p><b>Option Codes</b>                      Available</p>
		<p><b>Specify cable length in 1 metre increments e.g.</b>  <b>1 = 1 metre</b>  <b>2 = 2 metre etc.</b></p>	<p><b>A: Side Exit Cable.</b></p>
			
			
<p>0 Degrees</p> 	<p>0 Degrees</p> 		
			
			
			

**24CE/924CE**



## 924CE Series

### Miniature Safety Electromechanical Switch

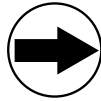

#### Technical Data

**Mechanical life** 10 million operations.

**Degree of protection** 924CE  
Standard type: IP 66  
With boot seal type: IP 67

**Temperature range** *Operating:* 0 °C to +105 °C /  
32 °F to +221 °F

**Approvals\*** IEC 60947-5-1  
EN 60947-5-1  
ac15 B300  
dc13 R300  
UL, CSA

**Electrical** According to IEC/EN 60947-5-1.  
Rated insulation voltage  
Ui = 500 V.  
Rated impulse withstand voltage  
Uimp = 2,5 kV.  
Not suitable for isolation.  
SCPD, Quick blow fuse to IEC  
127 suitable for rated current.

\* See Standards (page 179)

Dimensions in mm / in

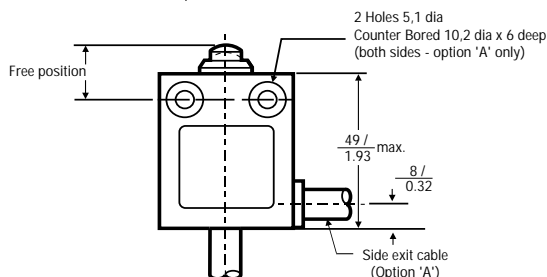
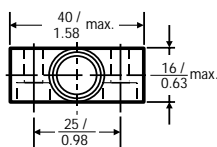

**Cable Type**  
3 or 5 x 18 AWG SJTO CABLE

**Ordering:**

**924CE**

Example: 924CE18-Y3A

#### Actuator Types

#### Slow Action Contacts 1 Normally Closed

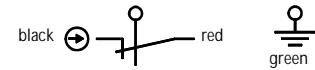

■ Circuit closed

\*Positive opening to IEC/EN 60947-5-1-3

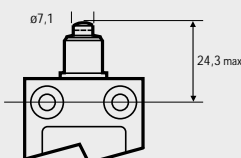
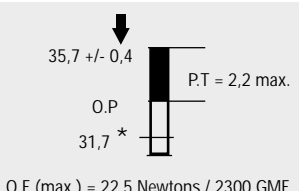
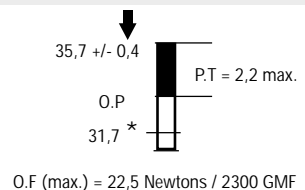
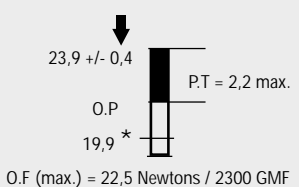
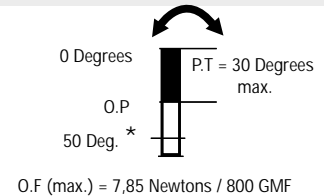
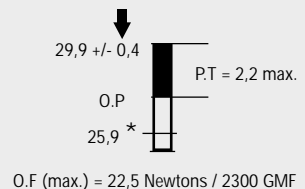
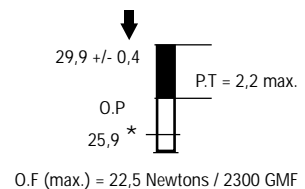
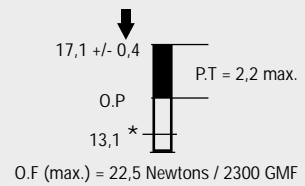

Pin Plunger (Boot Sealed)

**18**

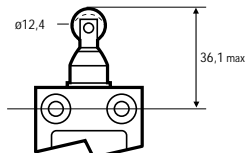

Roller Plunger Parallel (Boot Sealed)

**31**

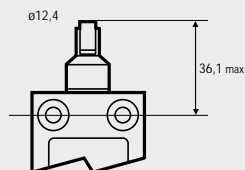

Roller Plunger Perpendicular (Boot Sealed)

**55**

**Y**

**X OR XX**

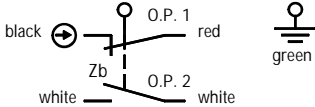
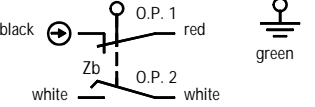
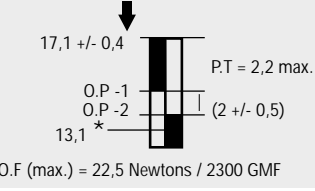
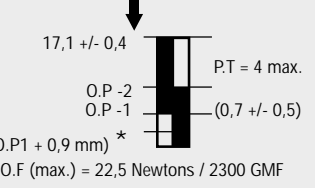
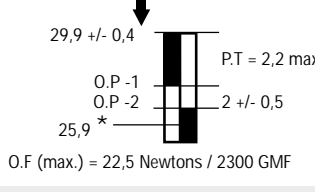
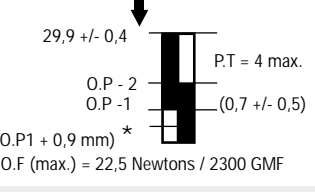
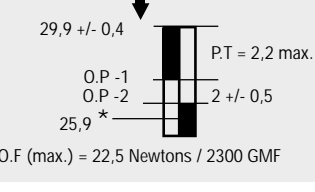
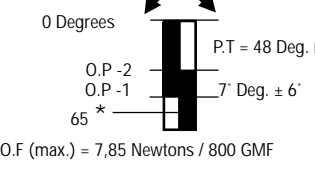
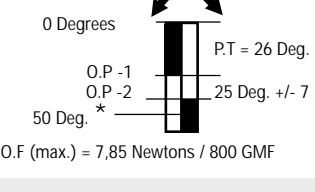
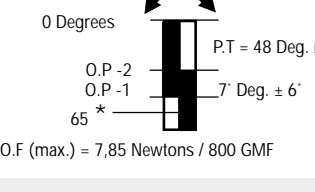
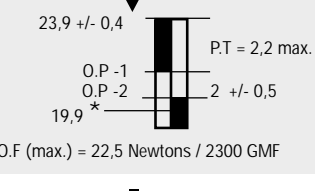
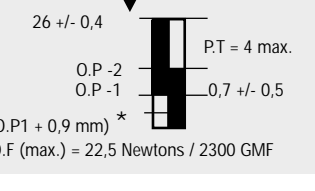
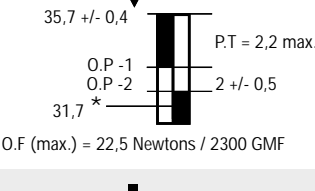
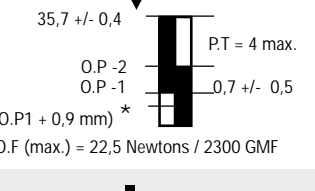
<b>Slow Action Contacts</b> <b>1 Normally Closed/                      Break before make</b>	<b>Slow Action Contacts</b> <b>1 Normally Closed/                      Make before break</b>	<b>Cable Length                      (in feet)</b>	<b>Option Codes</b>
		Specify cable length in 3 feet increments e.g. <b>3 = 3 feet</b> <b>6 = 6 feet etc.</b>	<b>A: Side Exit Cable</b>
			
			
			
			
			
			

24CE/924CE



