

10µA Supply Current, Low I_B, Zero-Drift Operational Amplifier

FEATURES

- **Low Supply Current: 10µA Maximum (per Amplifier)**
- **Offset Voltage: 5µV Maximum**
- **Offset Voltage Drift: 0.02µV/°C Maximum**
- **Input Bias Current:**
 - 5pA Typical
 - 50pA Maximum, -40°C to 85°C
 - 150pA Maximum, -40°C to 125°C
- **Integrated EMI Filter (90dB Rejection at 1.8GHz)**
- **Shutdown Current: 170nA Maximum (per Amplifier)**
- Rail-to-Rail Input and Output
- 1.7V to 5.25V Operating Supply Range
- A_{VOL}: 140dB Typical
- Low-Charge Power-Up for Duty Cycled Applications
- Specified Temperature Ranges:
 - -40°C to 85°C
 - -40°C to 125°C
- SC70, TSOT-23, MS8 and DFN Packages

APPLICATIONS

- Signal Conditioning in Wireless Mesh Networks
- Portable Instrumentation Systems
- Low-Power Sensor Conditioning
- Gas Detection
- Temperature Measurement
- Medical Instrumentation
- Energy Harvesting Applications
- Low Power Current Sensing

DESCRIPTION

The **LTC®2066/LTC2067** are single and dual low power, zero-drift, 100kHz amplifiers. The LTC2066/LTC2067 enable high resolution measurement at extremely low power levels.

Typical supply current is 7.5µA per amplifier with a maximum of 10µA. The available shutdown mode has been optimized to minimize power consumption in duty-cycled applications and features low charge loss during power-up, reducing total system power.

The LTC2066/LTC2067's self-calibrating circuitry results in very low input offset (5µV max) and offset drift (0.02µV/°C). The maximum input bias current is only 35pA and does not exceed 150pA over the full specified temperature range. The extremely low input bias current of the LTC2066/LTC2067 allows the use of high value power-saving resistors in the feedback network.

With its ultralow quiescent current and outstanding precision, the LTC2066/LTC2067 can serve as a signal chain building block in portable, energy harvesting and wireless sensor applications.

The LTC2066 is available in 6-lead SC70 and 5-lead TSOT-23 packages. The LTC2067 is available in 8-lead MSOP and 10-lead DFN packages. These devices are fully specified over the -40°C to 85°C and -40°C to 125°C temperature ranges.

All registered trademarks and trademarks are the property of their respective owners.

TYPICAL APPLICATION

Precision Micropower Low Side Current Sense

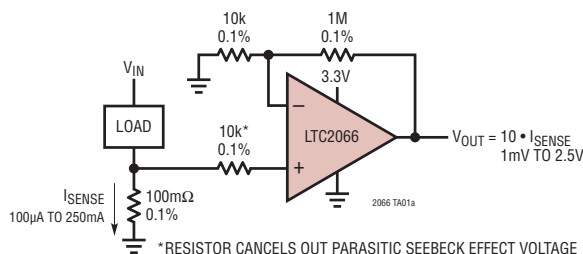

Output Voltage vs Sense Current

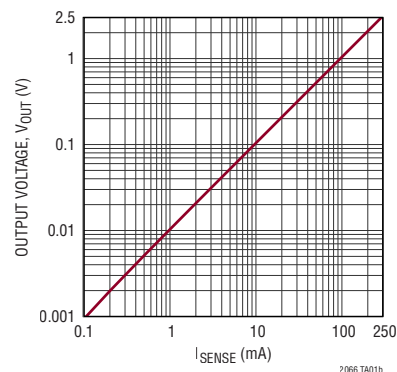

LTC2066/LTC2067

ABSOLUTE MAXIMUM RATINGS (Note 1)

Total Supply Voltage (V^+ to V^-)	5.5V	Output Short-Circuit Duration (Note 3)	Thermally Limited
Differential Input Current (+IN to -IN) (Note 2)	$\pm 10\text{mA}$	Operating and Specified Temperature Range (Note 4)	
Differential Input Voltage (+IN to -IN)	5.5V	LTC2066I/LTC2067I	-40°C to 85°C
Input Voltage		LTC2066H/LTC2067H	-40°C to 125°C
+IN, -IN, SHDN	$(V^-) - 0.3\text{V}$ to $(V^+) + 0.3\text{V}$	Maximum Junction Temperature	150°C
Input Current		Storage Temperature Range	-65°C to 150°C
+IN, -IN, SHDN (Note 2)	$\pm 10\text{mA}$		

PIN CONFIGURATION

<p>LTC2066</p> <p>SC6 PACKAGE 6-LEAD PLASTIC SC70 $\theta_{JA} = 265^\circ\text{C/W}$ (Note 5)</p>	<p>LTC2066</p> <p>S5 PACKAGE 5-LEAD PLASTIC TSOT-23 $\theta_{JA} = 215^\circ\text{C/W}$ (Note 5)</p>
<p>LTC2067</p> <p>MS8 PACKAGE 8-LEAD PLASTIC MSOP $\theta_{JA} = 163^\circ\text{C/W}$, $\theta_{JC} = 40^\circ\text{C/W}$ (Note 5)</p>	<p>LTC2067</p> <p>DD PACKAGE 10-LEAD (3mm x 3mm) PLASTIC DFN $\theta_{JA} = 43^\circ\text{C/W}$, $\theta_{JC} = 5.5^\circ\text{C/W}$ (Note 5) EXPOSED PAD (PIN 11) IS CONNECTED TO V^- (PIN 4) (PCB CONNECTION OPTIONAL)</p>

ORDER INFORMATION

TAPE AND REEL (MINI)	TAPE AND REEL	PART MARKING*	PACKAGE DESCRIPTION	TEMPERATURE RANGE
LTC2066ISC6#TRMPBF	LTC2066ISC6#TRPBF	LHDB	6-Lead Plastic SC70	-40°C to 85°C
LTC2066HSC6#TRMPBF	LTC2066HSC6#TRPBF	LHDB	6-Lead Plastic SC70	-40°C to 125°C
LTC2066IS5#TRMPBF	LTC2066IS5#TRPBF	LTHCZ	5-Lead Plastic TSOT-23	-40°C to 85°C
LTC2066HS5#TRMPBF	LTC2066HS5#TRPBF	LTHCZ	5-Lead Plastic TSOT-23	-40°C to 125°C
LTC2067IMS8#TRMPBF	LTC2067IMS8#TRPBF	LTHDC	8-Lead Plastic MSOP	-40°C to 85°C
LTC2067HMS8#TRMPBF	LTC2067HMS8#TRPBF	LTHDC	8-Lead Plastic MSOP	-40°C to 125°C
LTC2067IDD#TRMPBF	LTC2067IDD#TRPBF	LHDD	10-Lead (3mm x 3mm) Plastic DFN	-40°C to 85°C
LTC2067HDD#TRMPBF	LTC2067HDD#TRPBF	LHDD	10-Lead (3mm x 3mm) Plastic DFN	-40°C to 125°C

Contact the factory for parts specified with wider operating temperature ranges. *The temperature grade is identified by a label on the shipping container.

Parts ending with PBF are RoHS and WEEE compliant.

[Tape and reel specifications](#). Some packages are available in 500 unit reels through designated sales channels with #TRMPBF suffix.

ELECTRICAL CHARACTERISTICS The ● denotes the specifications which apply over the full operating temperature range, otherwise specifications are at $T_A = 25^\circ\text{C}$. Unless otherwise noted, $V_S = 1.8\text{V}$, $V_{\text{CM}} = V_{\text{OUT}} = V_S/2$, $V_{\text{SHDN}} = 1.8\text{V}$, R_L to $V_S/2$.

SYMBOL	PARAMETER	CONDITIONS	MIN	TYP	MAX	UNITS
V_{OS}	Input Offset Voltage (Note 6)	$V_S = 1.7\text{V}$	●	1	± 5 ± 10	μV μV
$\Delta V_{\text{OS}}/\Delta T$	Input Offset Voltage Drift (Note 6)	-40°C to 85°C -40°C to 125°C	● ●		± 0.03 ± 0.05	$\mu\text{V}/^\circ\text{C}$ $\mu\text{V}/^\circ\text{C}$
I_B	Input Bias Current (Note 7)			± 2		pA
I_{OS}	Input Offset Current (Note 7)			± 4		pA
i_n	Input Noise Current Spectral Density	$f \leq 100\text{Hz}$		35		$\text{fA}/\sqrt{\text{Hz}}$
e_n	Input Noise Voltage Spectral Density	$f \leq 100\text{Hz}$		90		$\text{nV}/\sqrt{\text{Hz}}$
$e_{n\text{ P-P}}$	Input Noise Voltage	DC to 10Hz		1.9		$\mu\text{V}_{\text{P-P}}$
C_{IN}	Input Capacitance	Differential Common Mode		3.3 3.5		pF pF
V_{CMR}	Input Voltage Range	Guaranteed by CMRR	●	$(V^-) - 0.1$	$(V^+) + 0.1$	V
CMRR	Common Mode Rejection Ratio (Note 8)	$V_{\text{CM}} = (V^-) - 0.1\text{V}$ to $(V^+) + 0.1\text{V}$ $R_L = 499\text{k}$	● ●	103 100	123	dB dB
PSRR	Power Supply Rejection Ratio	$V_S = 1.7\text{V}$ to 5.25V $R_L = 499\text{k}$	●	108 106	126	dB dB
A_{VOL}	Open Loop Gain	$V_{\text{OUT}} = (V^-) + 0.1\text{V}$ to $(V^+) - 0.1\text{V}$, $R_L = 499\text{k}$		135		dB
V_{OL}	Output Voltage Swing Low ($V_{\text{OUT}} - V^-$)	$R_L = 499\text{k}$ $R_L = 10\text{k}$	●	0.05 3	10 20	mV mV mV
V_{OH}	Output Voltage Swing High ($V^+ - V_{\text{OUT}}$)	$R_L = 499\text{k}$ $R_L = 10\text{k}$	● ●	0.1 4.5	10 50	mV mV mV
I_{SC}	Output Short Circuit Current	Sourcing Sinking	● ●	5.8 4 10.4 5	7.5 13	mA mA mA mA
SR	Slew Rate	$A_V = +1$		17.5		V/ms
GBW	Gain Bandwidth Product	$R_L = 499\text{k}$		100		kHz
t_{ON}	Power-Up Time			0.4		ms
f_c	Internal Chopping Frequency			25		kHz
V_S	Supply Voltage Range	Guaranteed by PSRR	●	1.7	5.25	V
I_S	Supply Current per Amplifier	No Load -40°C to 85°C -40°C to 125°C In Shutdown ($\text{SHDN} = V^-$) -40°C to 85°C -40°C to 125°C	● ● ● ●	7.4 90	10 12.5 20 170 250 500	μA μA μA nA nA nA
V_H	SHDN Pin Threshold, Logic High (Referred to V^-)		●	1.0		V
V_L	SHDN Pin Threshold, Logic Low (Referred to V^-)		●		0.65	V
I_{SHDN}	SHDN Pin Current	$V_{\text{SHDN}} = 0\text{V}$	●	-150	-20	nA

ELECTRICAL CHARACTERISTICS The ● denotes the specifications which apply over the full operating temperature range, otherwise specifications are at $T_A = 25^\circ\text{C}$. Unless otherwise noted, $V_S = 5\text{V}$, $V_{\text{CM}} = V_{\text{OUT}} = V_S/2$, $V_{\text{SHDN}} = 5\text{V}$, R_L to $V_S/2$.

SYMBOL	PARAMETER	CONDITIONS	MIN	TYP	MAX	UNITS
V_{OS}	Input Offset Voltage (Note 6)	$V_S = 5.25\text{V}$	●	1	± 5 ± 10	μV μV
$\Delta V_{\text{OS}}/\Delta T$	Input Offset Voltage Drift (Note 6)	-40°C to 85°C -40°C to 125°C	● ●		± 0.02 ± 0.04	$\mu\text{V}/^\circ\text{C}$ $\mu\text{V}/^\circ\text{C}$
I_B	Input Bias Current	-40°C to 85°C -40°C to 125°C	● ●	± 5	± 35 ± 50 ± 150	pA pA pA
I_{OS}	Input Offset Current	-40°C to 85°C -40°C to 125°C	● ●	± 10	± 35 ± 50 ± 150	pA pA pA
i_n	Input Noise Current Spectral Density	$f \leq 100\text{Hz}$		35		$\text{fA}/\sqrt{\text{Hz}}$
e_n	Input Noise Voltage Spectral Density	$f \leq 100\text{Hz}$		80		$\text{nV}/\sqrt{\text{Hz}}$
$e_{\text{n P-P}}$	Input Noise Voltage	DC to 10Hz		1.7		$\mu\text{V}_{\text{P-P}}$
C_{IN}	Input Capacitance	Differential Common Mode		3.3 3.5		pF pF
V_{CMR}	Input Voltage Range	Guaranteed by CMRR	●	$(V^-) - 0.1$	$(V^+) + 0.1$	V
CMRR	Common Mode Rejection Ratio	$V_{\text{CM}} = (V^-) - 0.1\text{V}$ to $(V^+) + 0.1\text{V}$ $R_L = 499\text{k}$	●	111 108	134	dB dB
PSRR	Power Supply Rejection Ratio	$V_S = 1.7\text{V}$ to 5.25V $R_L = 499\text{k}$	●	108 106	126	dB dB
EMIRR	EMI Rejection Ratio $V_{\text{RF}} = 100\text{mV}_{\text{PK}}$ $\text{EMIRR} = 20 \cdot \log(V_{\text{RF}}/\Delta V_{\text{OS}})$	$f = 400\text{MHz}$ $f = 900\text{MHz}$ $f = 1800\text{MHz}$ $f = 2400\text{MHz}$			66 79 90 76	dB dB dB dB
A_{VOL}	Open Loop Gain	$V_{\text{OUT}} = (V^-) + 0.1\text{V}$ to $(V^+) - 0.1\text{V}$, $R_L = 499\text{k}$	●	112 110	140	dB dB
V_{OL}	Output Voltage Swing Low ($V_{\text{OUT}} - V^-$)	$R_L = 499\text{k}$ $R_L = 10\text{k}$	●	0.1 5.5	15 20	mV mV mV
V_{OH}	Output Voltage Swing High ($V^+ - V_{\text{OUT}}$)	$R_L = 499\text{k}$ $R_L = 10\text{k}$	●	0.15 7	15 20	mV mV mV
I_{SC}	Output Short Circuit Current	Sourcing Sinking	● ●	30 16 20 5	51	mA mA mA mA
SR	Slew Rate	$A_V = +1$		17.5		V/ms
GBW	Gain Bandwidth Product	$R_L = 499\text{k}$		100		kHz
t_{ON}	Power-Up Time			0.4		ms
f_C	Internal Chopping Frequency			25		kHz
V_S	Supply Voltage Range	Guaranteed by PSRR	●	1.7	5.25	V
I_S	Supply Current per Amplifier	No Load -40°C to 85°C -40°C to 125°C	● ● ●		7.5 10 12.5 20	μA μA μA μA
		In Shutdown ($\text{SHDN} = V^-$) -40°C to 85°C -40°C to 125°C	● ●		90 170 250 500	nA nA nA nA

ELECTRICAL CHARACTERISTICS The ● denotes the specifications which apply over the full operating temperature range, otherwise specifications are at $T_A = 25^\circ\text{C}$. Unless otherwise noted, $V_S = 5\text{V}$, $V_{\text{CM}} = V_{\text{OUT}} = V_S/2$, $V_{\text{SHDN}} = 5\text{V}$, R_L to $V_S/2$.

SYMBOL	PARAMETER	CONDITIONS	MIN	TYP	MAX	UNITS
V_H	SHDN Pin Threshold, Logic High (Referred to V^-)		● 1.8			V
V_L	SHDN Pin Threshold, Logic Low (Referred to V^-)		●		0.8	V
I_{SHDN}	SHDN Pin Current	$V_{\text{SHDN}} = 0\text{V}$	● -150		-20	nA

Note 1: Stresses beyond those listed under Absolute Maximum Ratings may cause permanent damage to the device. Exposure to any Absolute Maximum Rating condition for extended periods may affect device reliability and lifetime.

Note 2: The inputs are protected by two series connected ESD protection diodes to each power supply. The input current should be limited to less than 10mA. The input voltage should not exceed 300mV beyond the power supply.

Note 3: A heat sink may be required to keep the junction temperature below the absolute maximum rating when the output is shorted indefinitely.

Note 4: The LTC2066I/LTC2067I is guaranteed to meet specified performance from -40°C to 85°C . The LTC2066H/LTC2067H is guaranteed to meet specified performance from -40°C to 125°C .

Note 5: Thermal resistance varies with the amount of PC board metal connected to the package. The specified values are for short traces connected to the leads.

Note 6: These parameters are guaranteed by design. Thermocouple effects preclude measurements of these voltage levels during automated testing. V_{OS} is measured to a limit determined by test equipment capability.

Note 7: Input Bias Current, Input Offset Current and Open Loop Gain are only production tested at 5V. Input Bias Current and Input Offset Current at 1.8V are expected to meet 5V specifications.

Note 8: Minimum specifications for these parameters are limited by noise and the capabilities of the automated test system.

TYPICAL PERFORMANCE CHARACTERISTICS

Input Offset Voltage Distribution

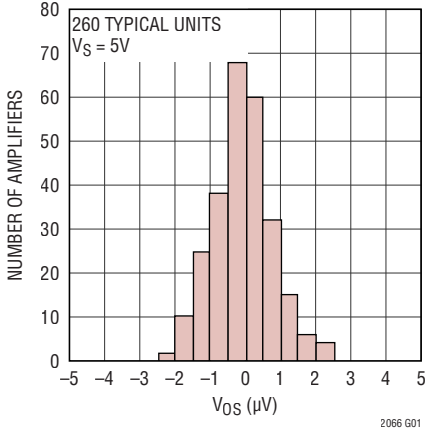

Input Offset Voltage Distribution

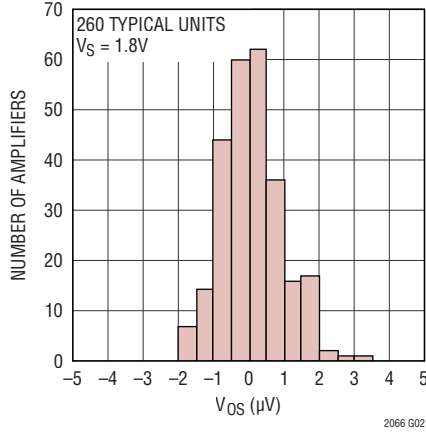

Input Offset Voltage Drift Distribution (H-Grade)

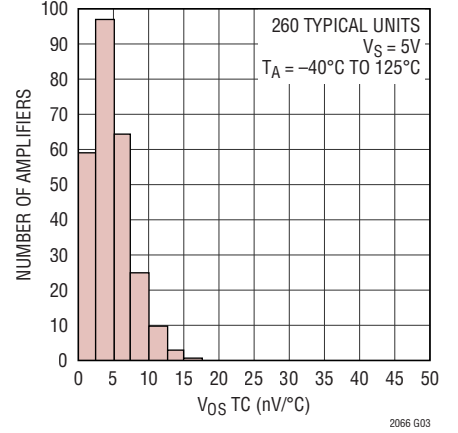

Input Offset Voltage Drift Distribution (H-Grade)

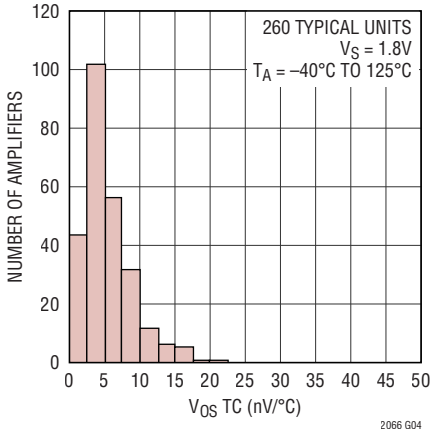

Input Offset Voltage Drift Distribution (I-Grade)

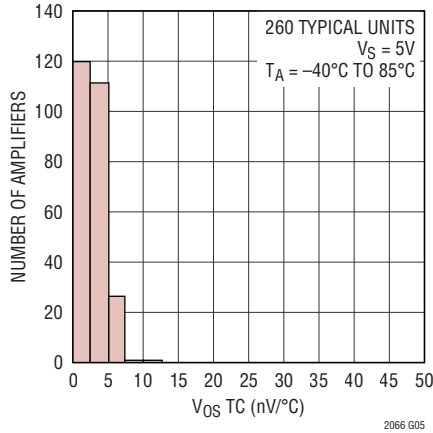

Input Offset Voltage Drift Distribution (I-Grade)

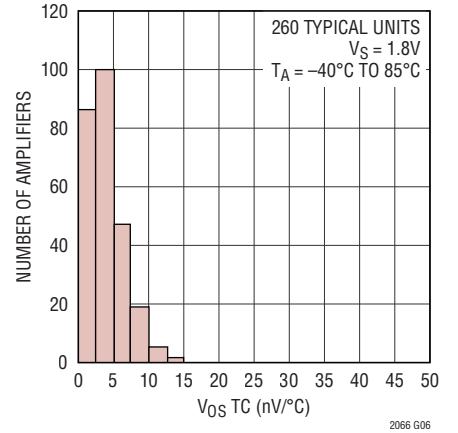

Input Offset Voltage vs Input Common Mode Voltage

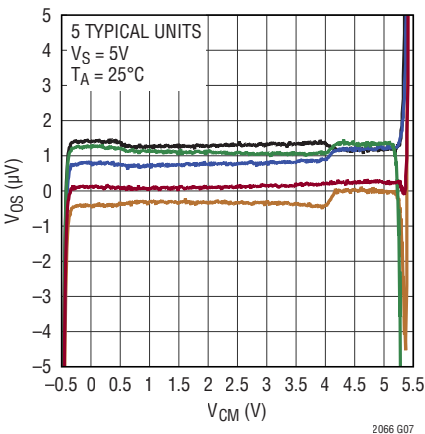

Input Offset Voltage vs Input Common Mode Voltage

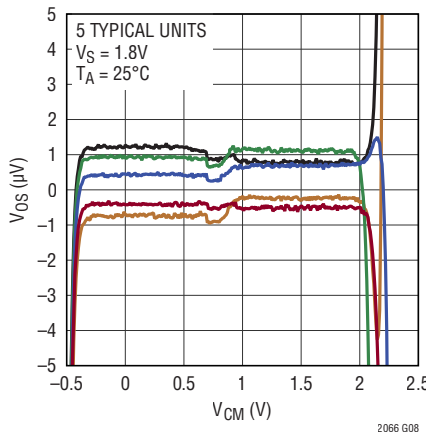

Input Offset Voltage vs Supply Voltage

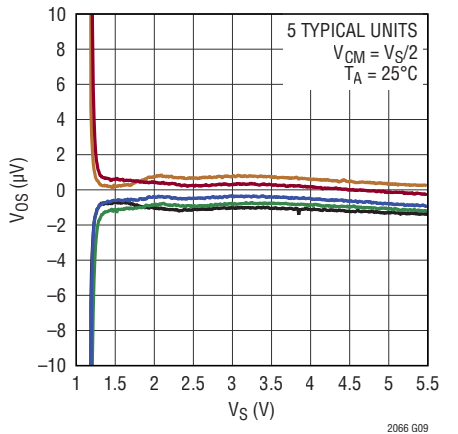

TYPICAL PERFORMANCE CHARACTERISTICS

Input Bias Current Distribution

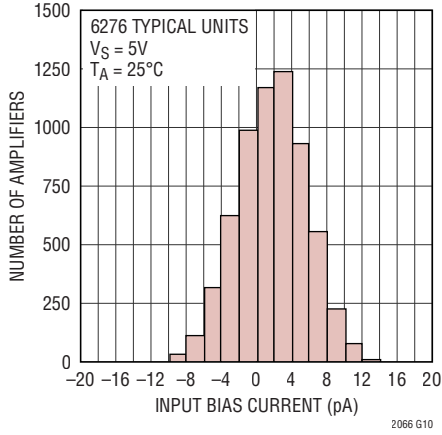

Input Bias Current Distribution

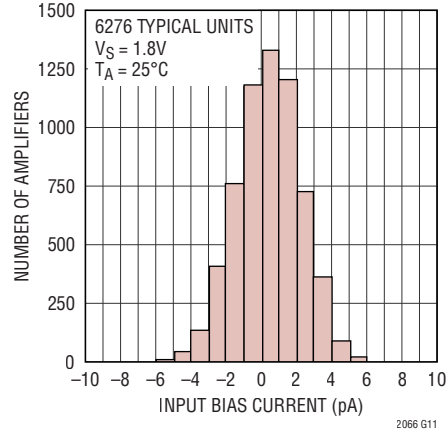

Input Bias Current vs Temperature

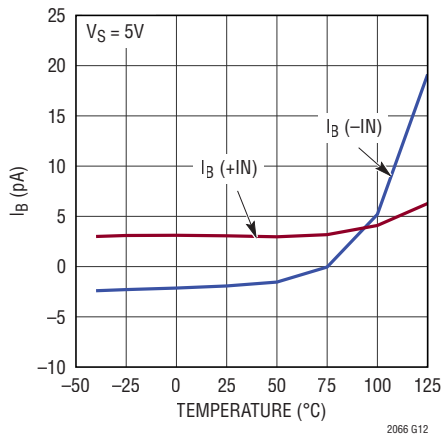

Input Bias Current vs Input Common Mode Voltage

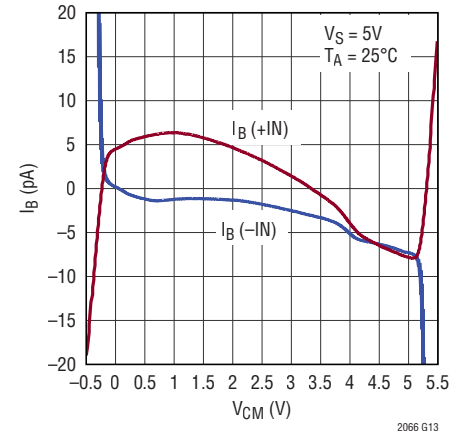

Input Bias Current vs Input Common Mode Voltage

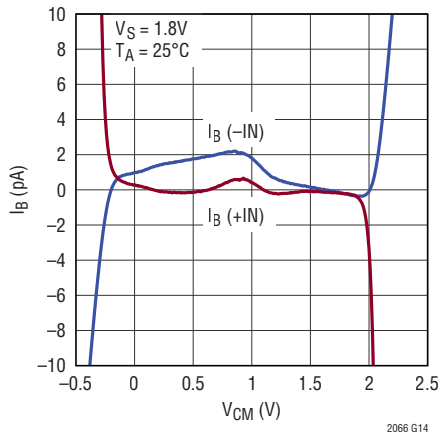

Input Bias Current vs Supply Voltage

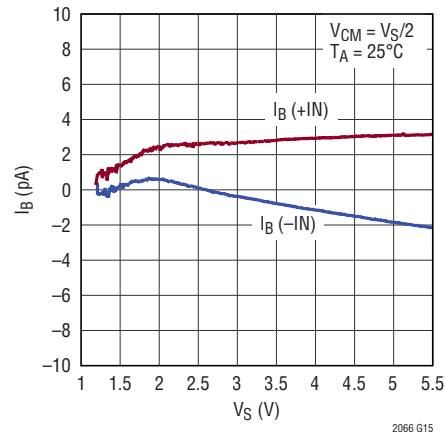

TYPICAL PERFORMANCE CHARACTERISTICS

Input Offset and Average Current vs Input Common Mode Voltage

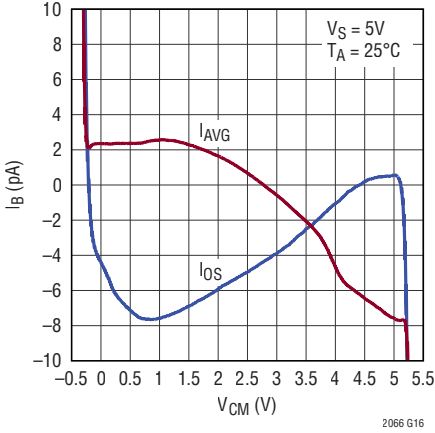

Input Offset and Average Current vs Input Common Mode Voltage

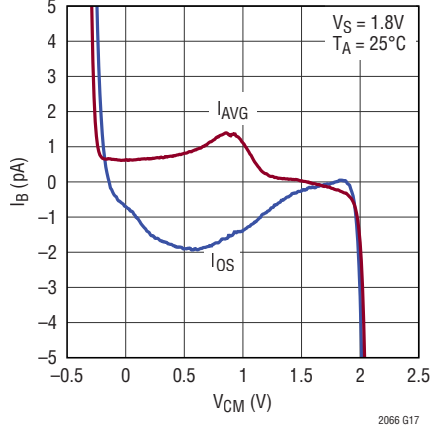

DC to 10Hz Voltage Noise

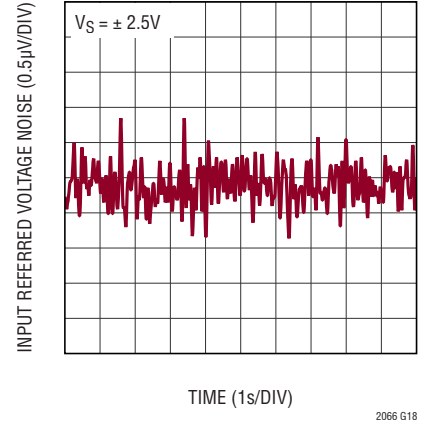

Input Referred Voltage Noise Density

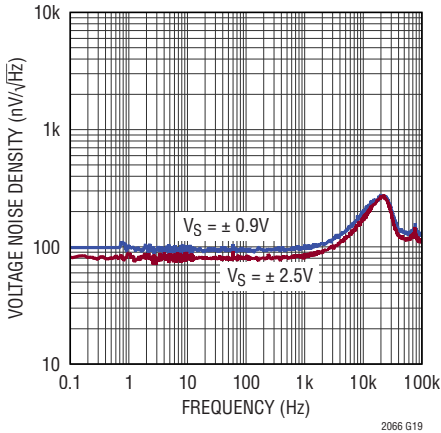

Input Referred Current Noise Density

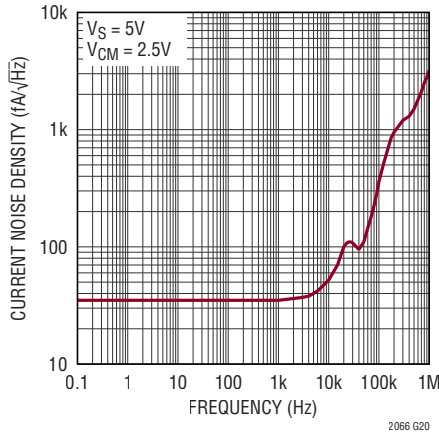

EMI Rejection vs Frequency

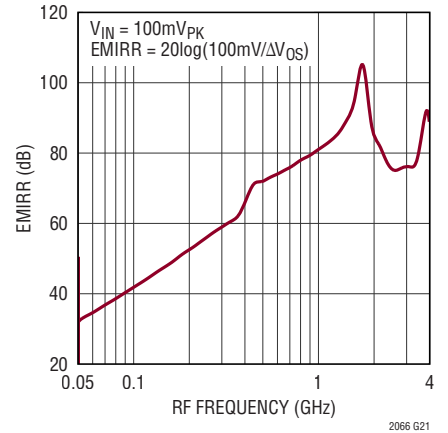

Common Mode Rejection Ratio vs Frequency

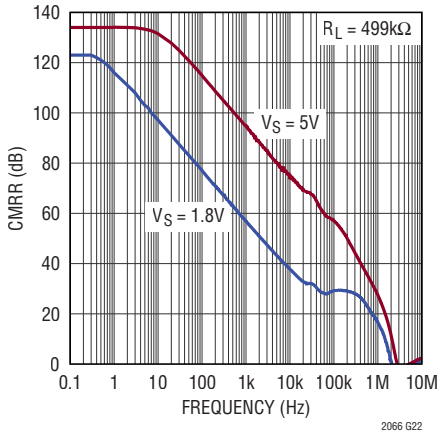

Power Supply Rejection Ratio vs Frequency

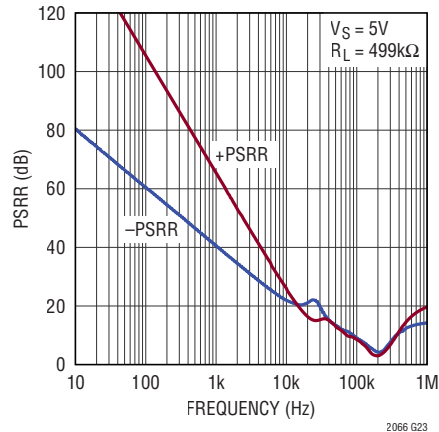

Closed Loop Gain vs Frequency

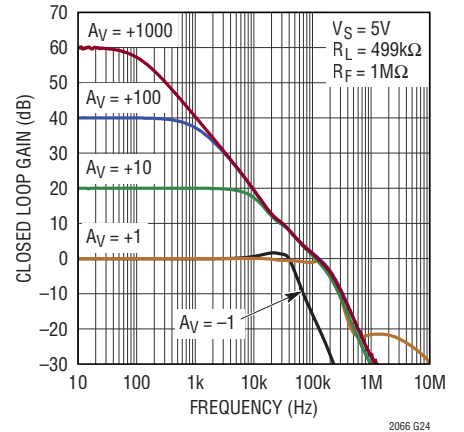

TYPICAL PERFORMANCE CHARACTERISTICS

Open Loop Gain and Phase vs Frequency

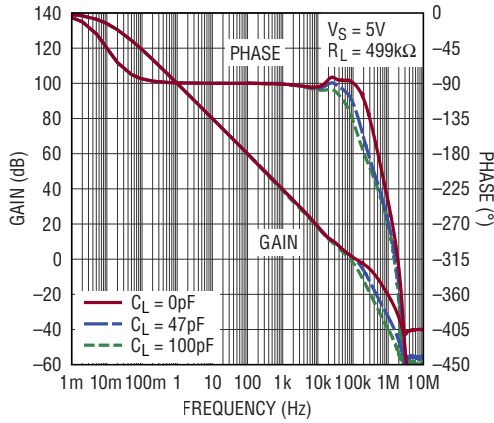

2066 G25

Open Loop Gain and Phase vs Frequency

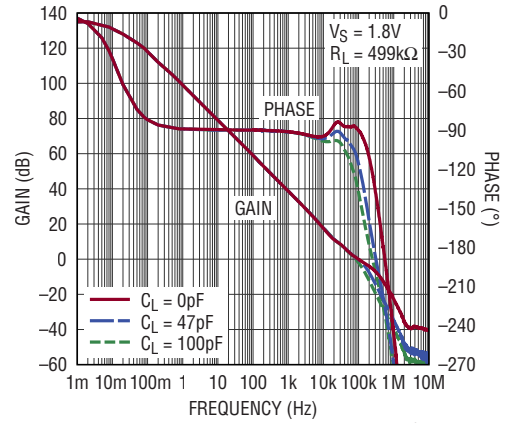

2066 G26

LTC2067 Crosstalk vs Frequency

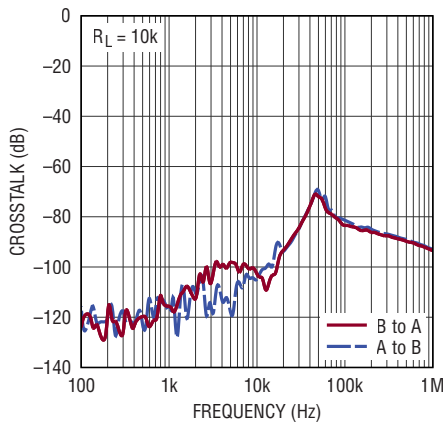

2066 G66

Open Loop Gain vs Load

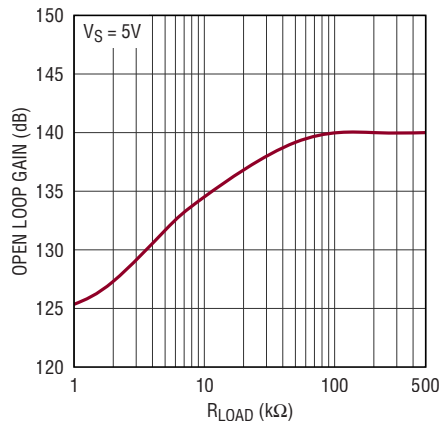

2066 G27

Shutdown Transient with Sinusoidal Input

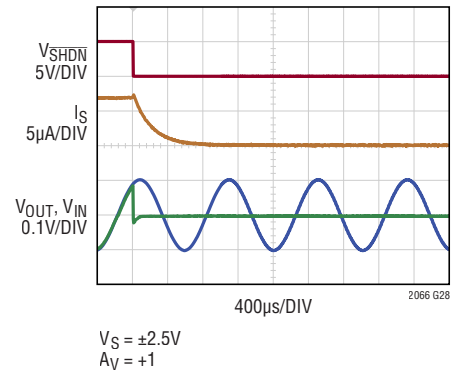

2066 G28

Shutdown Transient with Sinusoidal Input

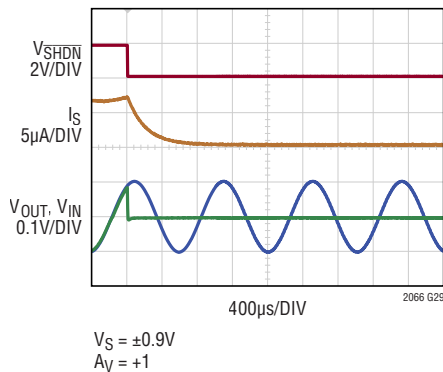

2066 G29

Enable Transient with Sinusoidal Input

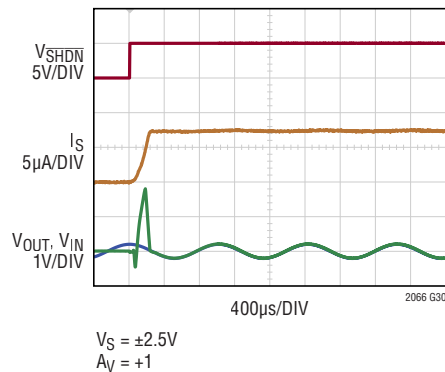

2066 G30

Enable Transient with Sinusoidal Input

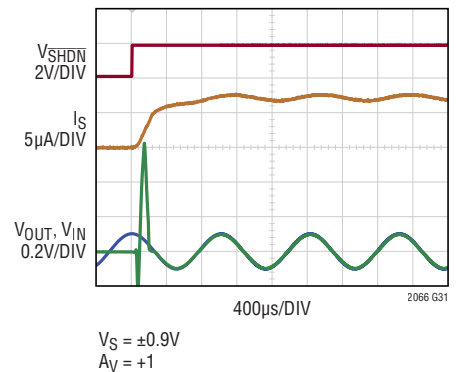

2066 G31

TYPICAL PERFORMANCE CHARACTERISTICS

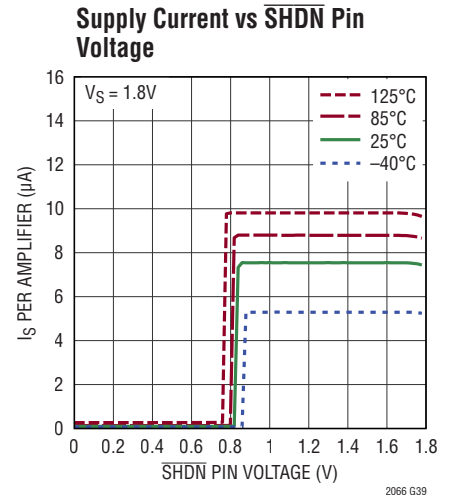
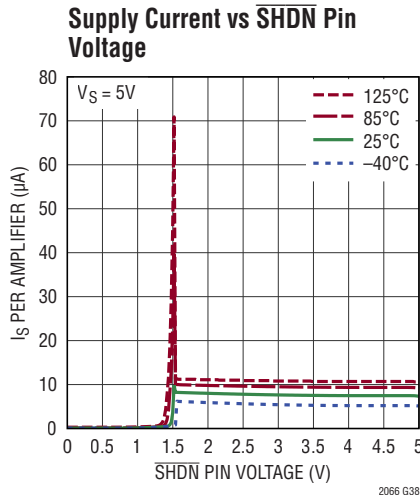
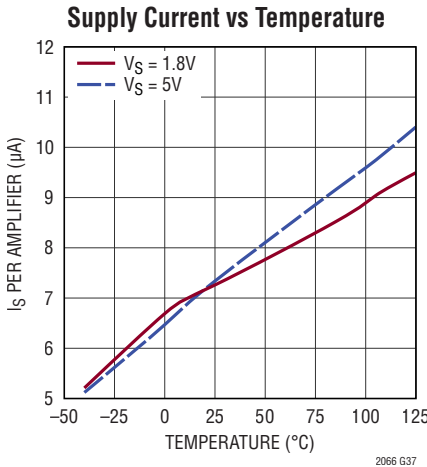
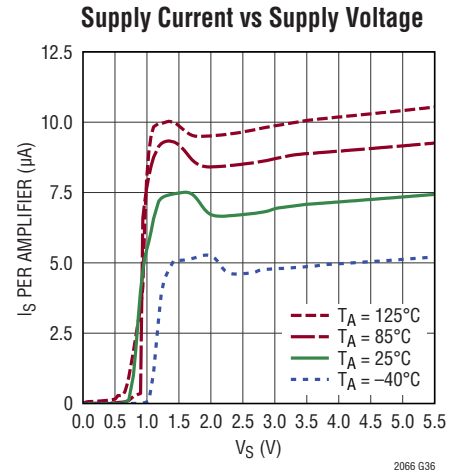
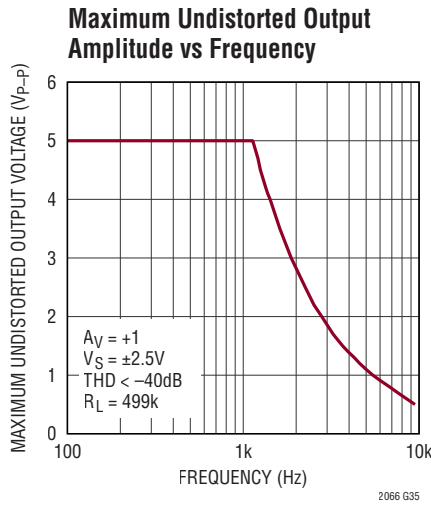
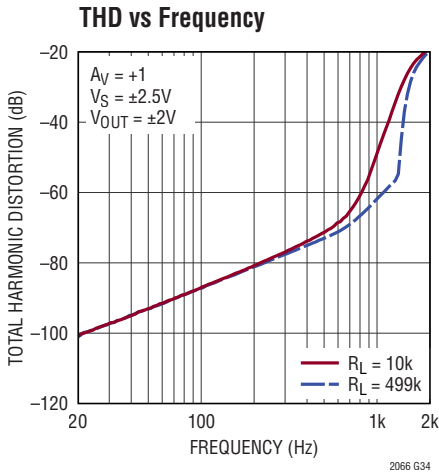
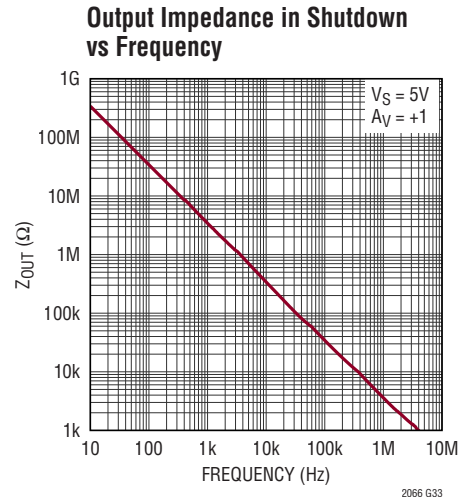
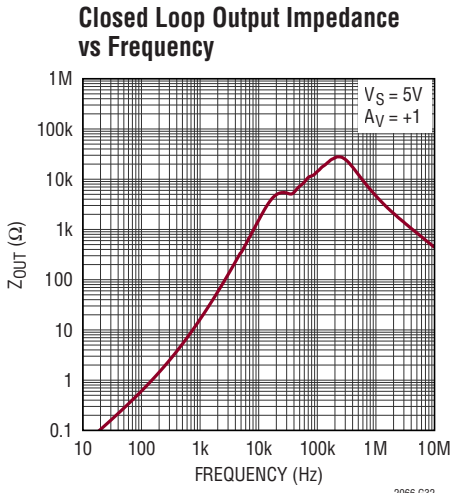

TYPICAL PERFORMANCE CHARACTERISTICS

SHDN Pin Pull-Up Current vs SHDN Pin Voltage

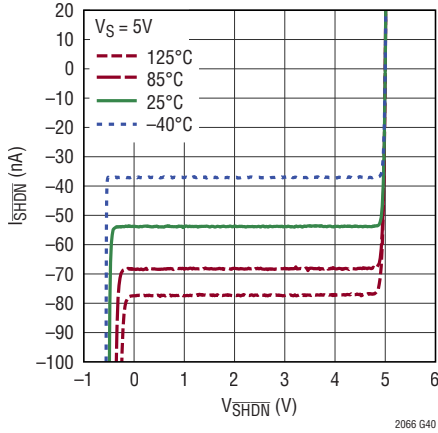

SHDN Pin Pull-Up Current vs SHDN Pin Voltage

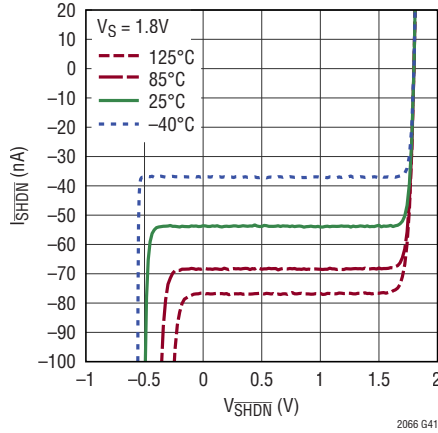

SHDN Pin Current vs Temperature

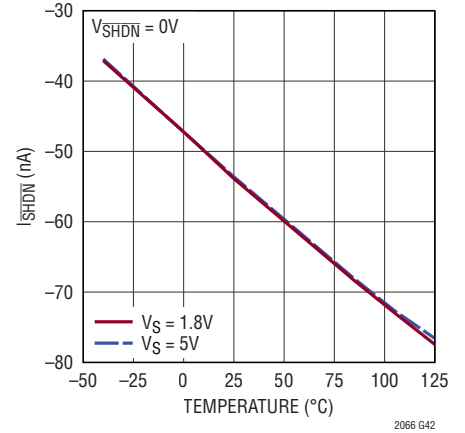

Shutdown Supply Current vs Supply Voltage

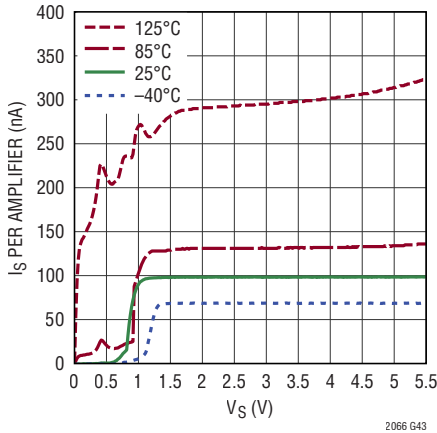

Shutdown Supply Current vs Temperature

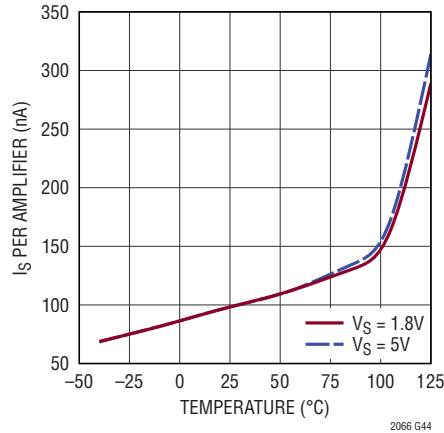

Output Voltage Swing High vs Load Current

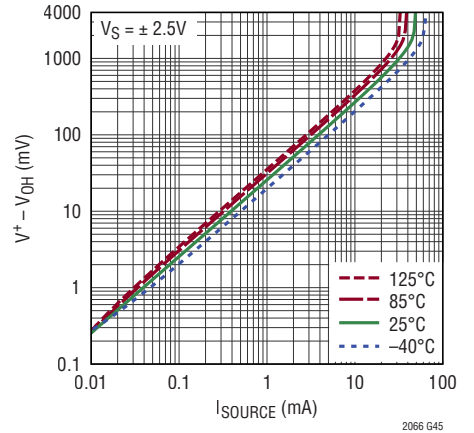

Output Voltage Swing High vs Load Current

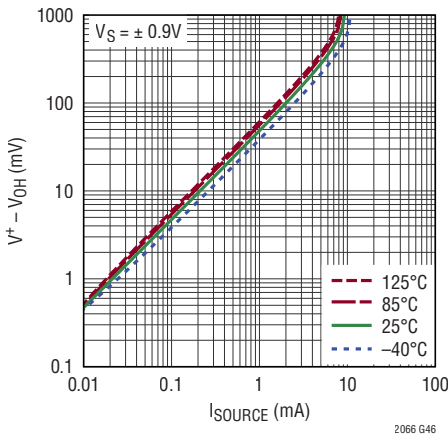

Output Voltage Swing Low vs Load Current

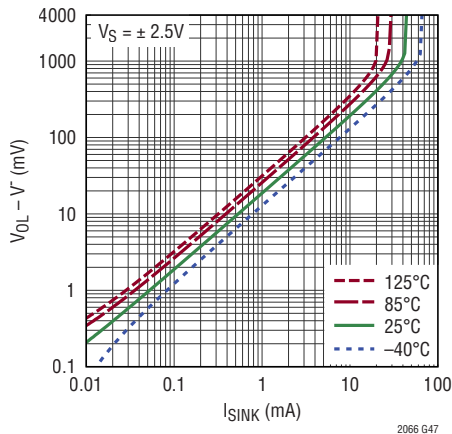

Output Voltage Swing Low vs Load Current

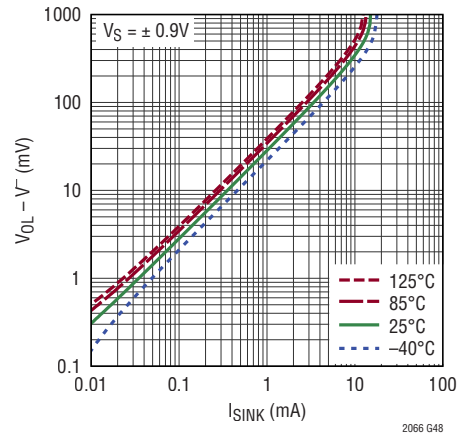

TYPICAL PERFORMANCE CHARACTERISTICS

No Phase Reversal

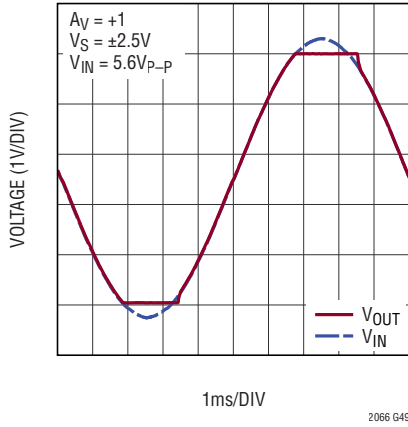

Output Short Circuit Current vs Temperature

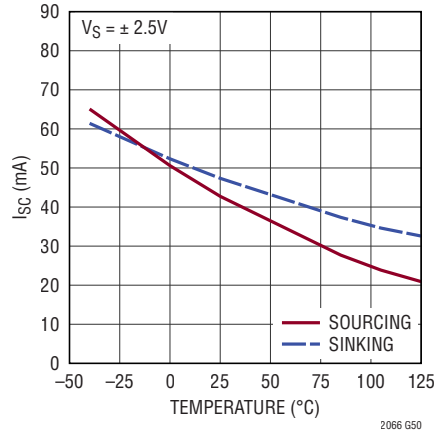

Output Short Circuit Current vs Temperature

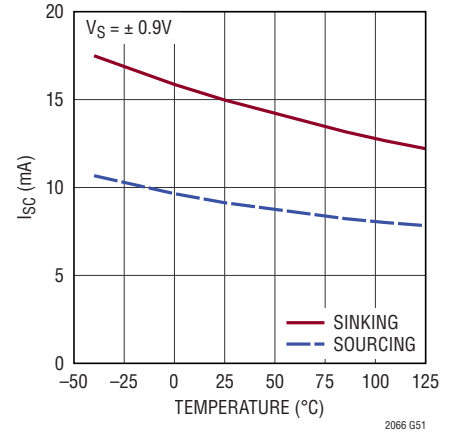

Large Signal Response

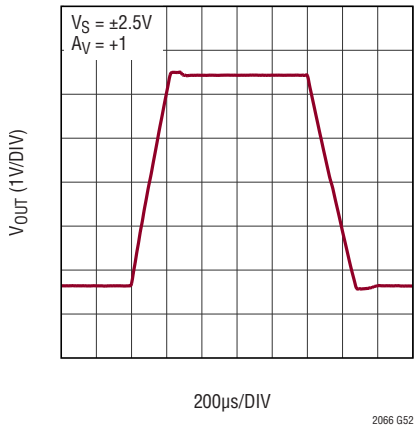

Large Signal Response

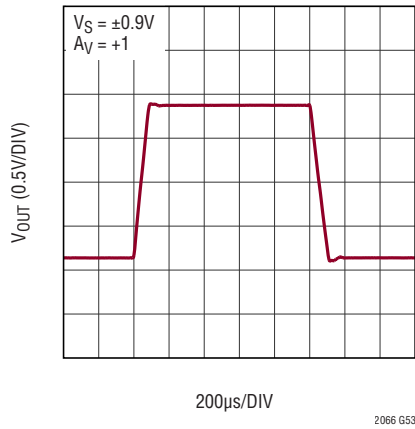

Small Signal Response

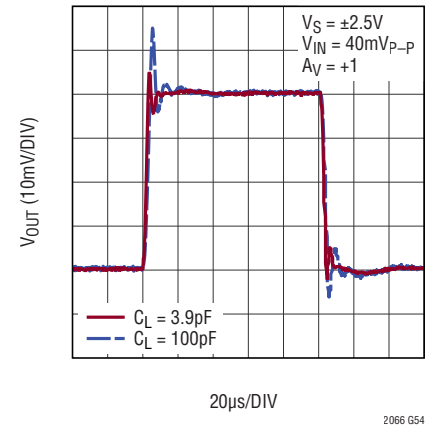

Small Signal Response

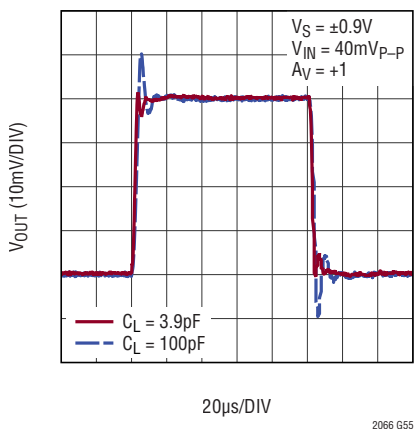

Small Signal Overshoot vs Load Capacitance

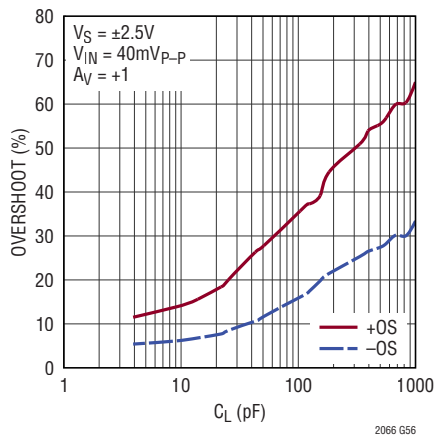

Small Signal Overshoot vs Load Capacitance

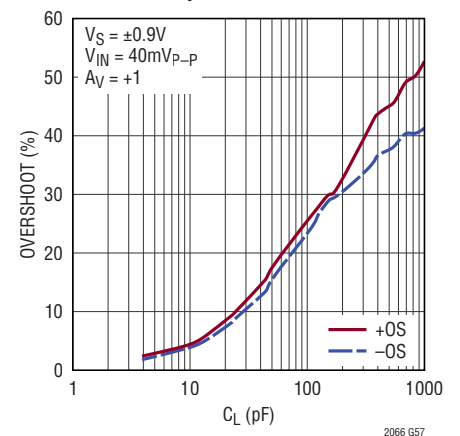

TYPICAL PERFORMANCE CHARACTERISTICS

Positive Output Overload Recovery

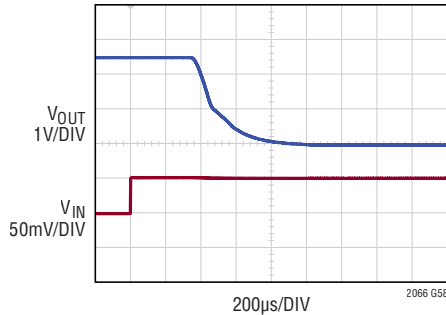

$V_S = \pm 2.5V$
 $A_V = -100$

Positive Output Overload Recovery

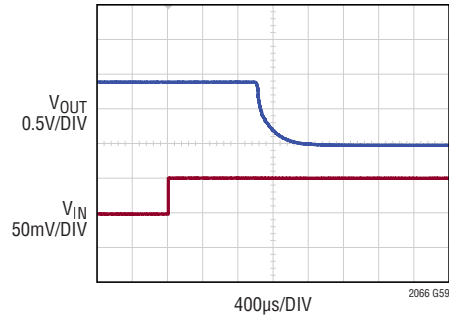

$V_S = \pm 0.9V$
 $A_V = -100$

Negative Output Overload Recovery

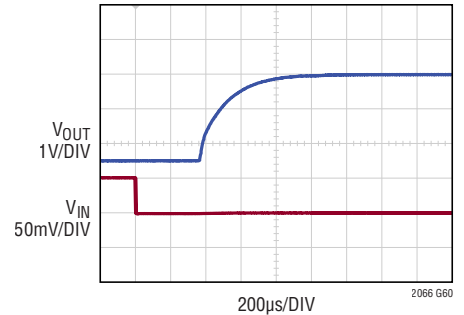

$V_S = \pm 2.5V$
 $A_V = -100$

Negative Output Overload Recovery

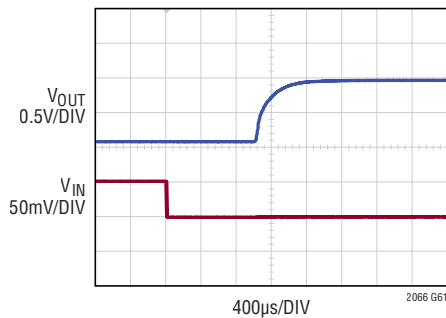

$V_S = \pm 0.9V$
 $A_V = -100$

Positive Input Overload Recovery

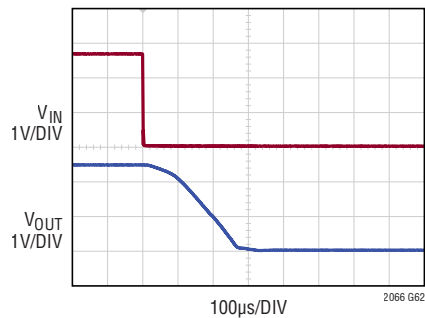

$V_S = \pm 2.5V$
 $A_V = +1$

Positive Input Overload Recovery

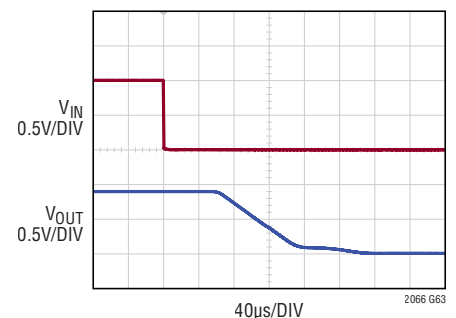

$V_S = \pm 0.9V$
 $A_V = +1$

Negative Input Overload Recovery

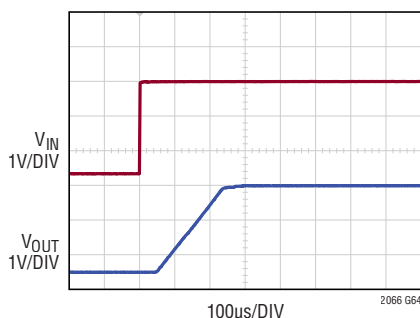

$V_S = \pm 2.5V$
 $A_V = +1$

Negative Input Overload Recovery

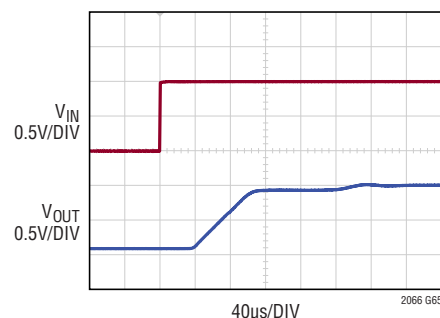

$V_S = \pm 0.9V$
 $A_V = +1$

PIN FUNCTIONS

OUT: Amplifier Output

-IN: Inverting Amplifier Input

+IN: Noninverting Amplifier Input

V⁺: Positive Power Supply. A bypass capacitor should be used between supply pins and ground.

V⁻: Negative Power Supply. A bypass capacitor should be used between supply pins and ground.

$\overline{\text{SHDN}}$: Shutdown Control Pin. The $\overline{\text{SHDN}}$ pin threshold is referenced to V⁻. If tied to V⁺, the part is enabled. If tied to V⁻, the part is disabled and draws less than 170nA of supply current per amplifier. It is recommended not to float this pin.

BLOCK DIAGRAM

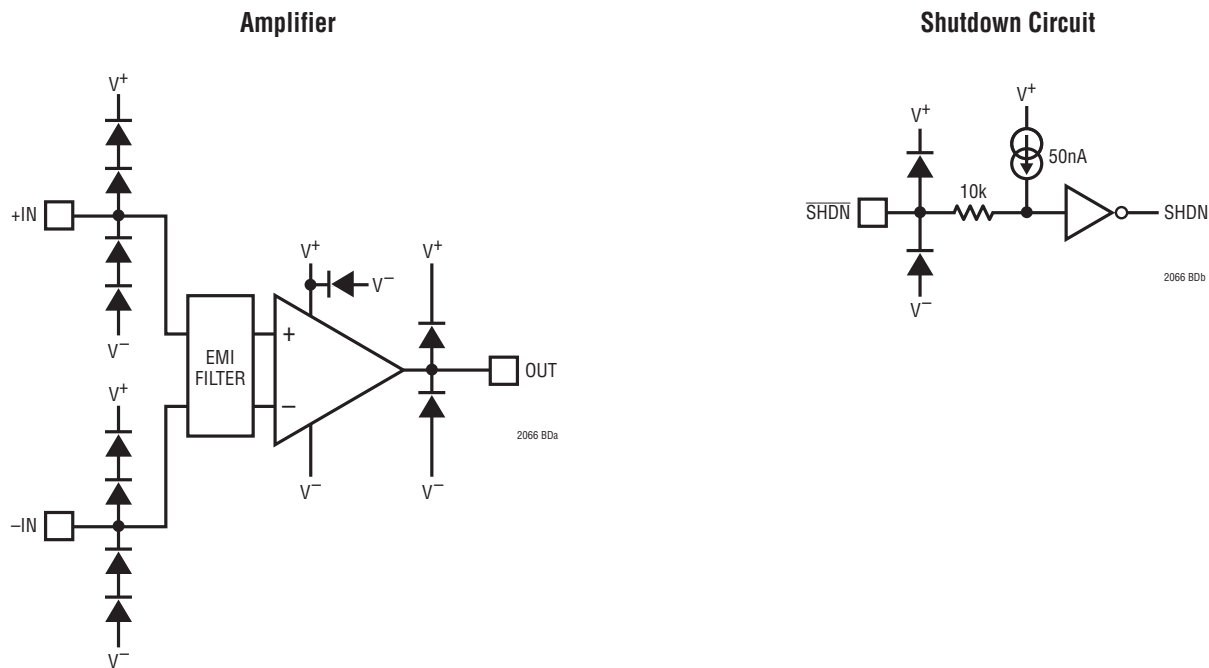

APPLICATIONS INFORMATION

Using the LTC2066/LTC2067

The LTC2066/LTC2067 are single and dual zero-drift operational amplifiers with the open-loop voltage gain and bandwidth characteristics of a conventional operational amplifier. Advanced circuit techniques allow the LTC2066/LTC2067 to operate continuously through its entire bandwidth while self-calibrating unwanted errors.

Input Voltage Noise

Zero-drift amplifiers like the LTC2066/LTC2067 achieve low input offset voltage and $1/f$ noise by heterodyning DC and flicker noise to higher frequencies. In early zero-drift amplifiers, this process resulted in idle tones at the self-calibration frequency, often referred to as the chopping frequency. These artifacts made early zero-drift amplifiers difficult to use. The advanced circuit techniques used by the LTC2066/LTC2067 suppress these spurious artifacts, allowing for trouble-free use.

Input Current Noise

For applications with high source and feedback impedances, input current noise can be a significant contributor to total output noise. For this reason, it is important to consider noise current interaction with circuit elements placed at the amplifier's inputs.

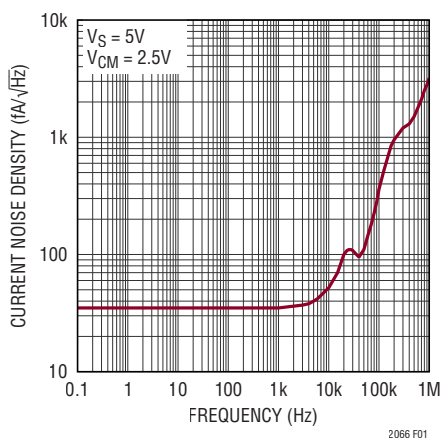

Figure 1. Input Current Noise Spectrum

The current noise spectrum of the LTC2066/LTC2067 is shown in Figure 1. Low input current noise is achieved through the use of MOSFET input devices and self-calibration techniques to eliminate $1/f$ current noise. As with all zero-drift amplifiers, there is an increase in current noise at the offset-nulling frequency. This phenomenon is discussed in the Input Bias Current and Clock Feedthrough section.

Input current noise also rises with frequency due to capacitive coupling of MOSFET channel thermal noise.

Input Bias Current and Clock Feedthrough

The input bias current of zero-drift amplifiers has different characteristics than that of a traditional operational amplifier. The specified input bias current is the DC average of transient currents which conduct due to the input stage's switching circuitry. In addition to this, junction leakages can contribute additional input bias current at elevated temperatures. Through careful design and the use of an innovative boot-strap circuit the input bias current of the LTC2066/LTC2067 does not exceed 35pA at room and 150pA over the full temperature range. This minimizes bias current induced errors even in high impedance circuits.

Transient switching currents at the input interact with source and feedback impedances producing error voltages which are indistinguishable from a valid input signal. The resulting error voltages are amplified by the amplifier's closed-loop gain, which acts as a filter, attenuating frequency components above the circuit bandwidth. This phenomenon is known as clock feedthrough and is present in all zero-drift amplifiers. Understanding the cause and effect of clock feedthrough is important when using zero-drift amplifiers.

For zero-drift amplifiers, clock feedthrough is proportional to source and feedback impedances, as well as the magnitude of the transient currents. These transient currents have been minimized in the LTC2066/LTC2067 to allow use with high source and feedback impedances. Many circuit designs require high feedback impedances

APPLICATIONS INFORMATION

to minimize power consumption and/or require a sensor which is intrinsically high impedance. In these cases, a capacitor can be used, either at the input or across the feedback resistor, to limit the bandwidth of the closed-loop system. Doing so will effectively filter out the clock feedthrough signal.

Thermocouple Effects

In order to achieve accuracy on the microvolt level, thermocouple effects must be considered. Any connection of dissimilar metals forms a thermoelectric junction and generates a small temperature-dependent voltage. Also known as the Seebeck Effect, these thermal EMFs can be the dominant error source in low-drift circuits.

Connectors, switches, relay contacts, sockets, resistors, and solder are all candidates for significant thermal EMF generation. Even junctions of copper wire from different manufacturers can generate thermal EMFs of $200\text{nV}/^\circ\text{C}$, which significantly exceeds the maximum drift specification of the LTC2066/LTC2067. Figures 2 and 3 illustrate the potential magnitude of these voltages and their sensitivity to temperature.

In order to minimize thermocouple-induced errors, attention must be given to circuit board layout and component selection. It is good practice to minimize the number of junctions in the amplifier's input signal path and avoid connectors, sockets, switches, and relays whenever possible. If such components are required, they should be selected for low thermal EMF characteristics. Furthermore, the number, type, and layout of junctions should be matched for both inputs with respect to thermal gradients on the circuit board. Doing so may involve deliberately introducing dummy junctions to offset unavoidable junctions.

Air currents can also lead to thermal gradients and cause significant noise in measurement systems. It is important to prevent airflow across sensitive circuits. Doing so will often reduce thermocouple noise substantially. A summary of techniques can be found in Figure 4.

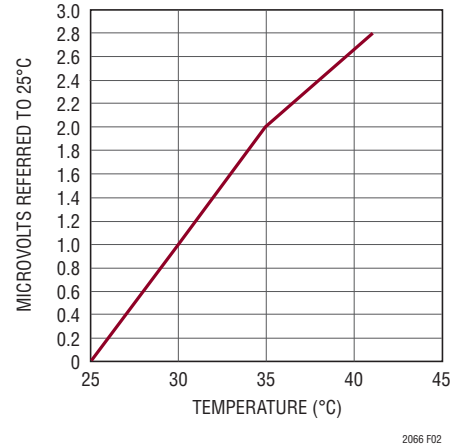

Figure 2. Thermal EMF Generated by Two Copper Wires from Different Manufacturers

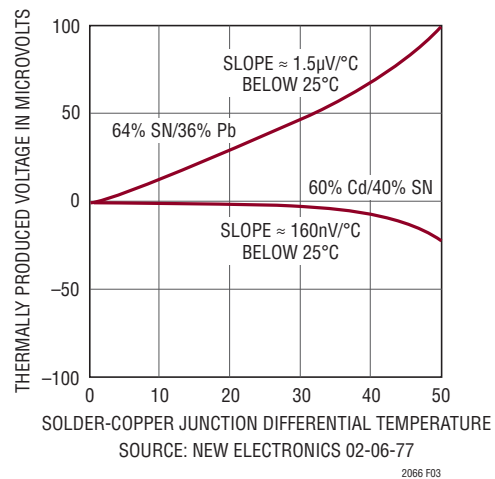
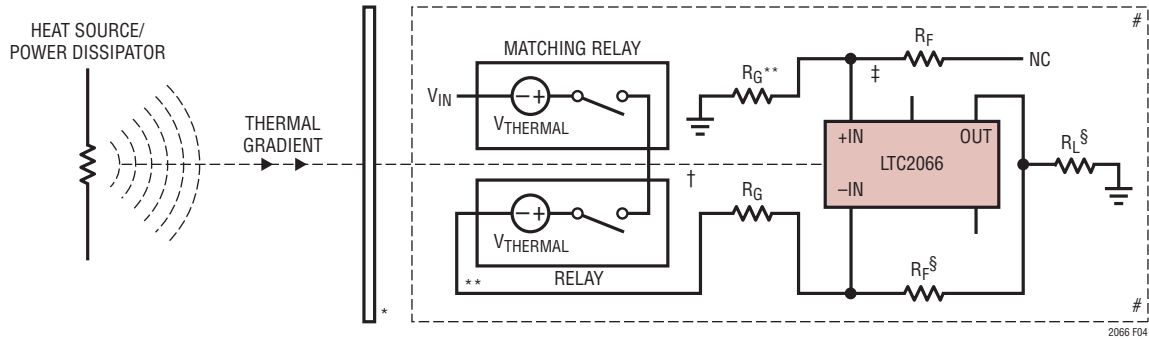

Figure 3. Solder-Copper Thermal EMFs

Leakage Effects

Leakage currents into high impedance signal nodes can easily degrade measurement accuracy of sub-nanoamp signals. High voltage and high temperature applications are especially susceptible to these issues. Quality insulation materials should be used, and insulating surfaces should be cleaned to remove fluxes and other residues. For humid environments, surface coating may be necessary to provide a moisture barrier.

APPLICATIONS INFORMATION



- * CUT SLOTS IN PCB FOR THERMAL ISOLATION.
- ** INTRODUCE DUMMY JUNCTIONS AND COMPONENTS TO OFFSET UNAVOIDABLE JUNCTIONS OR CANCEL THERMAL EMFs.
- † ALIGN INPUTS SYMMETRICALLY WITH RESPECT TO THERMAL GRADIENTS.
- ‡ INTRODUCE DUMMY TRACES AND COMPONENTS FOR SYMMETRICAL THERMAL HEAT SINKING.
- § LOADS AND FEEDBACK CAN DISSIPATE POWER AND GENERATE THERMAL GRADIENTS. BE AWARE OF THEIR THERMAL EFFECTS.
- # COVER CIRCUIT TO PREVENT AIR CURRENTS FROM CREATING THERMAL GRADIENTS.

Figure 4. Techniques for Minimizing Thermocouple-Induced Errors

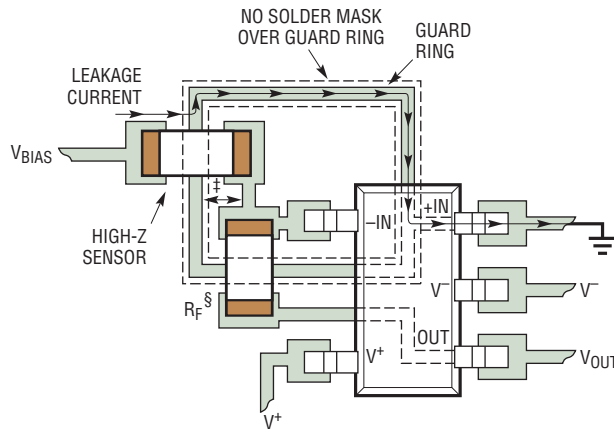

- ‡ NO LEAKAGE CURRENT, $V_{-IN} = V_{+IN}$
- § AVOID DISSIPATING SIGNIFICANT AMOUNTS OF POWER IN THIS RESISTOR. IT WILL GENERATE THERMAL GRADIENTS WITH RESPECT TO THE INPUT PINS AND LEAD TO THERMOCOUPLE-INDUCED ERROR. THERMALLY ISOLATE OR ALIGN WITH INPUTS IF RESISTOR WILL CAUSE HEATING.

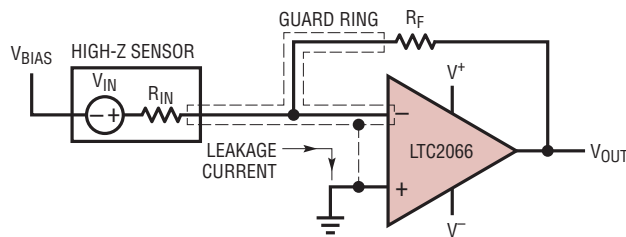

LEAKAGE CURRENT IS ABSORBED BY GROUND INSTEAD OF CAUSING A MEASUREMENT ERROR.

2066 F05

Figure 5. Example Layout of Inverting Amplifier with Leakage Guard Ring

APPLICATIONS INFORMATION

Board leakage can be minimized by encircling the input connections with a guard ring operated at a potential very close to that of the inputs. The ring must be tied to a low impedance node. For inverting configurations, the guard ring should be tied to the potential of the positive input (+IN). For noninverting configurations, the guard ring should be tied to the potential of the negative input (-IN). In order for this technique to be effective, the guard ring must not be covered by solder mask. Ringing both sides of the printed circuit board may be required. See Figure 5 for an example of proper layout.

Shutdown Mode

The LTC2066 in the SC70 package and the LTC2067 in the DFN package feature a shutdown mode for low-power applications. In the OFF state, each amplifier draws less than 170nA of supply current and the outputs present a high impedance to external circuitry.

Shutdown operation is accomplished by tying $\overline{\text{SHDN}}$ below V_L . If the shutdown feature is not required, it is recommended that $\overline{\text{SHDN}}$ be tied to V^+ . A current source pulls the $\overline{\text{SHDN}}$ pin high to keep the amplifier in the ON state when the pin is floated, however this may not be reliable at elevated temperatures due to board leakage (see $\overline{\text{SHDN}}$ Circuit Block Diagram, page 14). For operation in noisy environments, a capacitor between $\overline{\text{SHDN}}$ and V^+ is recommended to prevent noise from changing the shutdown state. When there is a danger of $\overline{\text{SHDN}}$ being pulled beyond the supply rails, resistance in series with the $\overline{\text{SHDN}}$ pin is recommended to limit the resulting current.

Start-Up Characteristics

Micropower op amps are often not micropower during start-up, which can cause problems when used on low current supplies. Large transient currents can conduct during power-up until the internal bias nodes settle to their final values. A large amount of current can be drawn from the supplies during this transient, which can sustain for several milliseconds in the case of a micropower part. In the worst case, there may not be enough supply cur-

rent available to take the system up to nominal voltages. In other cases, this transient power-up current will lead to added power loss in duty-cycled applications.

A way to quantify the transient current loss is to integrate the supply current during power-up to examine the total charge loss. If there were no additional transient current, the integrated supply current would appear as a smooth, straight line with a slope equal to the DC supply current of the part. Any deviation from a straight line indicates additional transient current that is drawn from the supply. The LTC2066/LTC2067 have been designed to minimize this charge loss during power-up so that power can be conserved in duty-cycled applications. Figure 6 shows the integrated supply current (i.e. charge) of the LTC2066 during power-up. Likewise, Figure 7 shows the charge loss due to enabling and disabling the part via the $\overline{\text{SHDN}}$ pin.

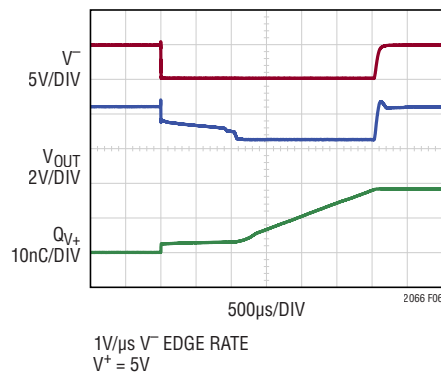

Figure 6. LTC2066 Charge Loss During Power-Up

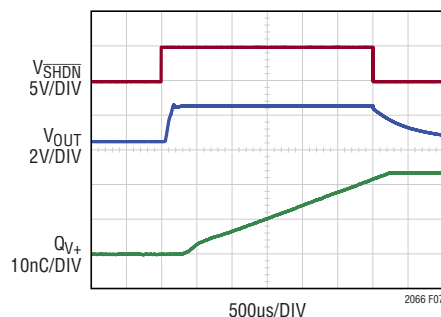

Figure 7. LTC2066 Charge Loss Due to Enabling and Disabling via $\overline{\text{SHDN}}$ Pin

APPLICATIONS INFORMATION

There are benefits when the $\overline{\text{SHDN}}$ pin is used to disable and enable the part in duty-cycled applications, rather than powering down the external supply voltage (V^+). Powering up and powering down the external supply will tend to waste charge due to charging and discharging the external decoupling capacitors. For these power-cycled applications, a relay or MOS device can be located after the decoupling capacitors to alleviate this; however there are drawbacks to this approach. The LTC2066 draws an initial charge of approximately 3nC when powered up. This recurring charge loss is unavoidable in power-cycled applications. Additionally, if the supply ramp rate exceeds $0.4\text{V}/\mu\text{s}$, an internal transient ESD clamp will trigger, conducting additional current from V^+ to V^- . This will waste charge and can make insignificant any gain that may have been expected by power-cycling the supply. Figure 8 shows the charge loss at power-up.

The shutdown pin can be used to overcome these limitations in duty-cycled applications. The typical charge loss transitioning into and out of shutdown is only 2.3nC. Since the supply is not transitioned, the external decoupling capacitors do not draw charge from the supply.

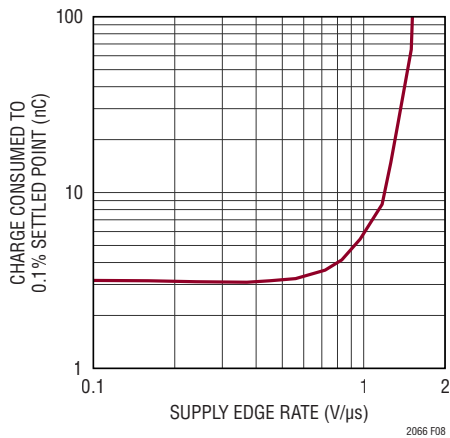

Figure 8. LTC2066 Power-Up Charge vs Supply Edge Rate

Gas Sensor

This low power precision gas sensor circuit operates in an oxygen level range of 0% to 30%, with a nominal output of 1V in normal atmospheric oxygen concentrations (20.9%) when the gas sensor has been fully initialized. Total active power consumption is less than $10.1\mu\text{A}$ on a single rail supply.

Since this gas sensor produces $100\mu\text{A}$ in a normal oxygen environment and requires a 100Ω load resistor, the resulting input signal is typically around 10mV. The LTC2066's rail-to-rail input means no additional DC level shifting is necessary, all the way down to very low oxygen concentrations.

Due to the extremely low input offset voltage of the LTC2066, which is $1\mu\text{V}$ typically and $5\mu\text{V}$ maximum, it is possible to gain up the mV-scale input signal substantially without introducing significant error. In the configuration shown in Figure 9, with a noninverting gain of $101\text{V}/\text{V}$, the worst-case input offset results in a maximum of 0.5mV offset on the 1V output, or 0.05% error.

Although the $100\text{k}\Omega$ resistor in series with the gas sensor does not strictly have the same precision requirement as the $10\text{M}\Omega$ and $100\text{k}\Omega$ resistors that set the gain, it is important to use a similar resistor at both input terminals. This helps to minimize additional offset voltage at the inputs due to thermocouple effects and bias current, hence the similar 0.1% precision requirement.

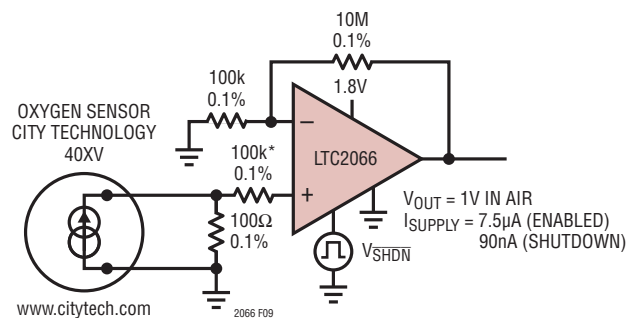

*RESISTOR CANCELS OUT PARASITIC SEEBECK EFFECT VOLTAGE

Figure 9. Micropower Precision Oxygen Sensor

APPLICATIONS INFORMATION

RTD Sensor

This low power platinum resistance temperature detector (RTD) sensor circuit draws only 43 μ A total supply current on a minimum 2.6V rail, and is accurate to within $\pm 1^\circ\text{C}$ at room temperature, including all error intrinsic to the Vishay PTS Class F0.3 Variant RTD. It covers the temperature range from -40°C to 85°C in 10mV/ $^\circ\text{C}$ increments and produces an output of 1V at nominal room temperature of 25°C .

The LTC2066's extremely low typical offset of 1 μ V and typical input bias current of 5pA allows for the use of a very low excitation current in the RTD. Thus, self-heating is negligible, improving accuracy.

The LT5400-3, B-grade, is used to provide a $\pm 0.025\%$ matched resistor network that is effectively a precision 131:1 voltage divider. This precision divider forms one half of a bridge circuit, with the 0.1% 110k Ω and RTD in the other branch. Note that the 110k Ω 's precision requirement is to ensure matching with the RTD. The 11k Ω R2 serves to provide a DC offset for the entire bridge so that

the output is 1V at room temperature. Since bridge imbalances can lead to error, it is recommended to minimize the length of the leads connecting the RTD to reduce additional lead resistance.

The LT6656-2.048 reference helps create a known excitation current in the RTD at each temperature of operation, and also acts as a supply for the LTC2066, all while using less than 1 μ A itself. The LT6656 can accept input voltages anywhere between 2.6V and 18V, allowing for flexibility in selection of supply voltage while maintaining a fixed output range. The LT6656 reference can easily source the 43 μ A required to run the entire circuit, thanks to the LTC2066's 10 μ A maximum supply current and ability to handle microvolt signals produced by the RTD under low excitation current.

Care should be taken to minimize thermocouple effects by preventing significant thermal gradients between the two op amp inputs. It is also important to choose feedback and series resistors that are low-tempco to minimize error due to drift over the entire temperature range.

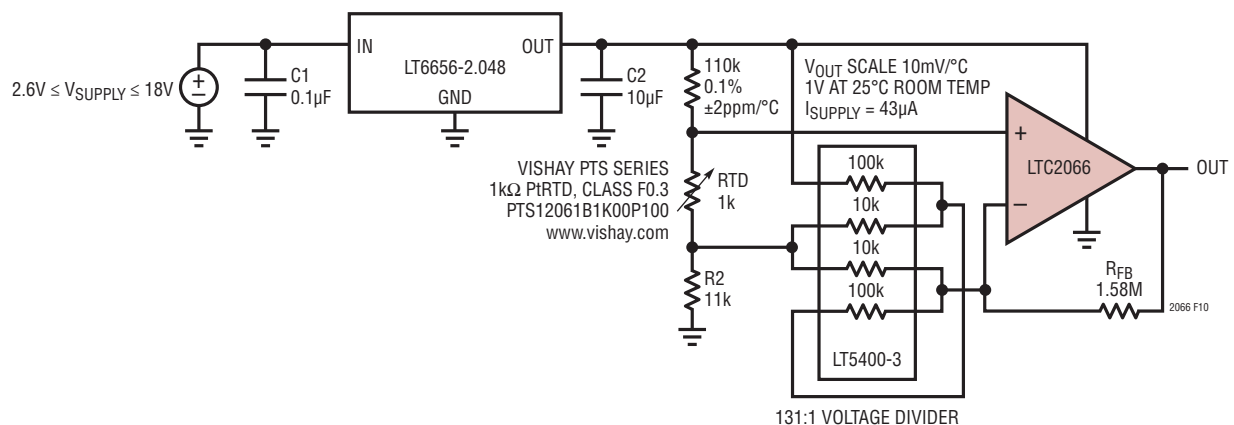

Figure 10. RTD Sensor

APPLICATIONS INFORMATION

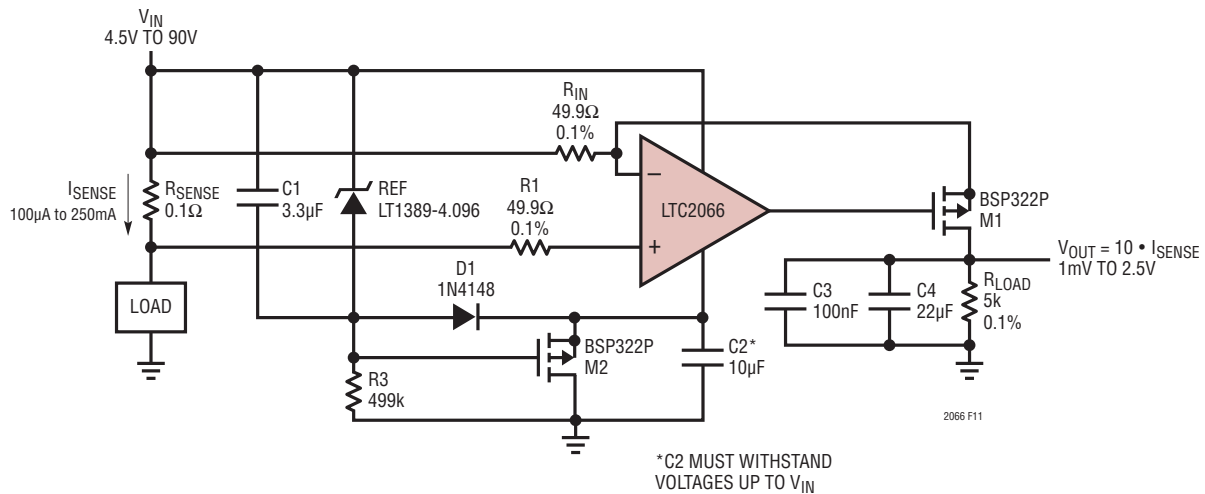

Figure 11. High Side Current Sense

High Side Current Sense

This micropower precision LTC2066 high side current sense circuit measures currents from 100μA to 250mA over a 4.5V to 90V input voltage range.

The output of this circuit is:

$$V_{OUT} = \frac{R_{LOAD} \cdot R_{SENSE}}{R_{IN}} I_{SENSE} = 10 \cdot I_{SENSE}$$

The LTC2066's low typical input offset voltage of 1μV and low input bias current of 5pA contribute output errors that are much smaller than the error due to precision limitations of the resistors used. Thus, output accuracy is mainly set by the accuracy of the resistors R_{SENSE}, R_{IN},

and R_{LOAD}. R1 helps cancel out parasitic Seebeck effect voltages at –IN by balancing with an identical voltage at +IN.

The LT1389-4.096 reference, along with the bootstrap circuit composed of M2, R3, and D1, establishes a very low power isolated 3V rail that protects the LTC2066 from reaching its absolute maximum voltage of 5.5V while allowing for much higher input voltages.

Since the LTC2066's gain-bandwidth product is 100kHz, it is recommended to use this circuit to measure currents that do not change faster than 10kHz. Note that the output filter as drawn will limit the frequency to 1.5Hz, which optimizes for lowest noise.

APPLICATIONS INFORMATION

Parallel LTC2067 Amplifiers to Reduce Noise by $\sqrt{2}$

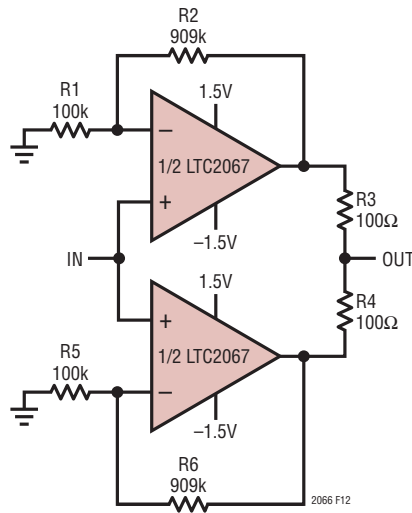

Precision, Micropower Carbon Monoxide Detector

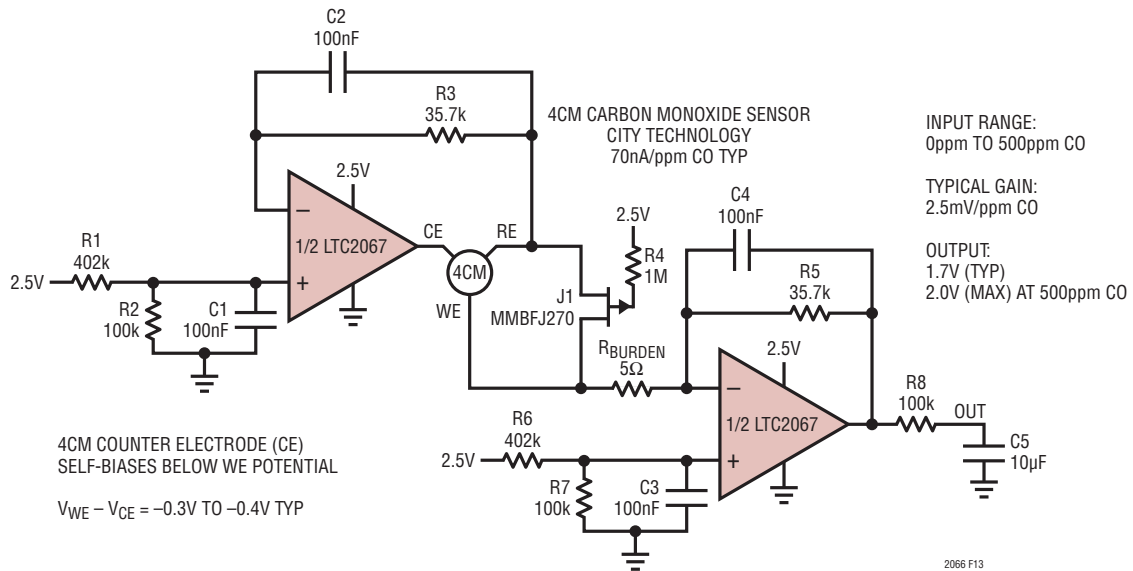

PACKAGE DESCRIPTION

SC6 Package 6-Lead Plastic SC70

(Reference LTC DWG # 05-08-1638 Rev B)

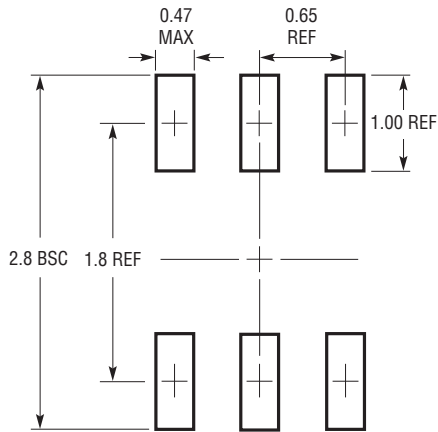

RECOMMENDED SOLDER PAD LAYOUT
PER IPC CALCULATOR

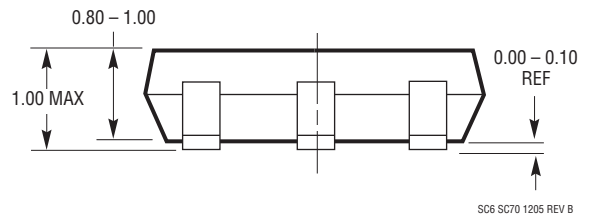
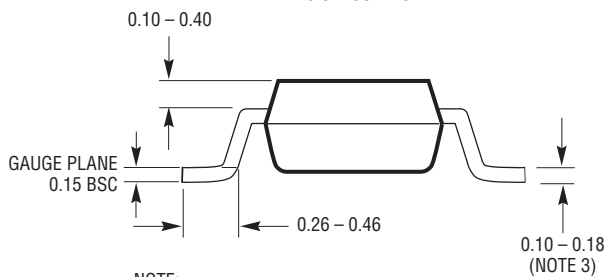
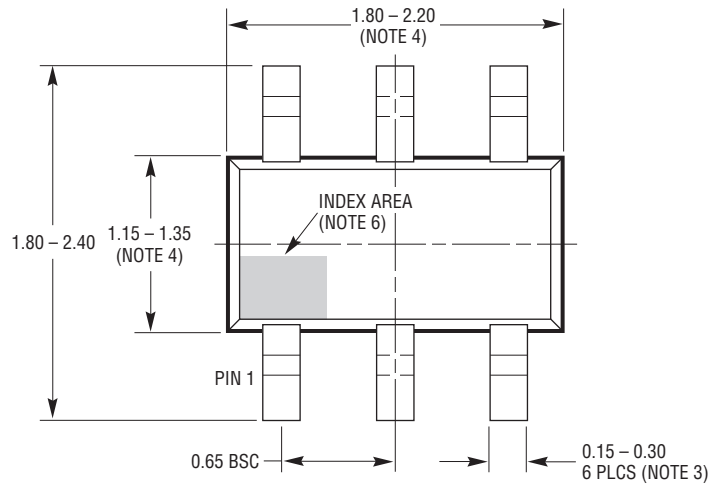

SC6 SC70 1205 REV B

NOTE:

1. DIMENSIONS ARE IN MILLIMETERS
2. DRAWING NOT TO SCALE
3. DIMENSIONS ARE INCLUSIVE OF PLATING
4. DIMENSIONS ARE EXCLUSIVE OF MOLD FLASH AND METAL BURR
5. MOLD FLASH SHALL NOT EXCEED 0.254mm
6. DETAILS OF THE PIN 1 IDENTIFIER ARE OPTIONAL,
BUT MUST BE LOCATED WITHIN THE INDEX AREA
7. EIAJ PACKAGE REFERENCE IS EIAJ SC-70
8. JEDEC PACKAGE REFERENCE IS MO-203 VARIATION AB

PACKAGE DESCRIPTION

S5 Package
5-Lead Plastic TSOT-23
 (Reference LTC DWG # 05-08-1635)

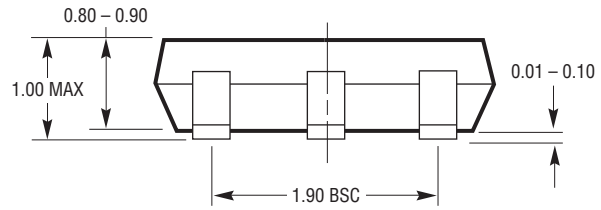
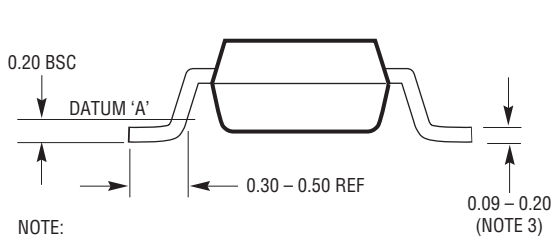
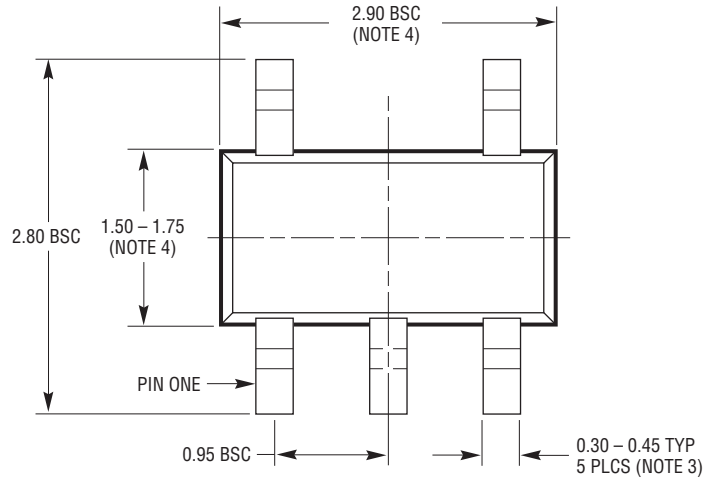
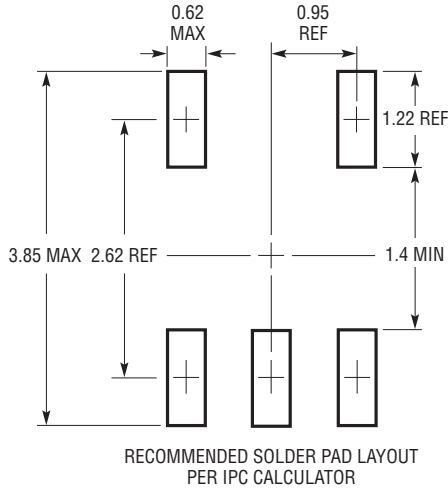

- NOTE:
1. DIMENSIONS ARE IN MILLIMETERS
 2. DRAWING NOT TO SCALE
 3. DIMENSIONS ARE INCLUSIVE OF PLATING
 4. DIMENSIONS ARE EXCLUSIVE OF MOLD FLASH AND METAL BURR
 5. MOLD FLASH SHALL NOT EXCEED 0.254mm
 6. JEDEC PACKAGE REFERENCE IS MO-193

S5 TSOT-23 0302

PACKAGE DESCRIPTION

MS8 Package 8-Lead Plastic MSOP

(Reference LTC DWG # 05-08-1660 Rev G)

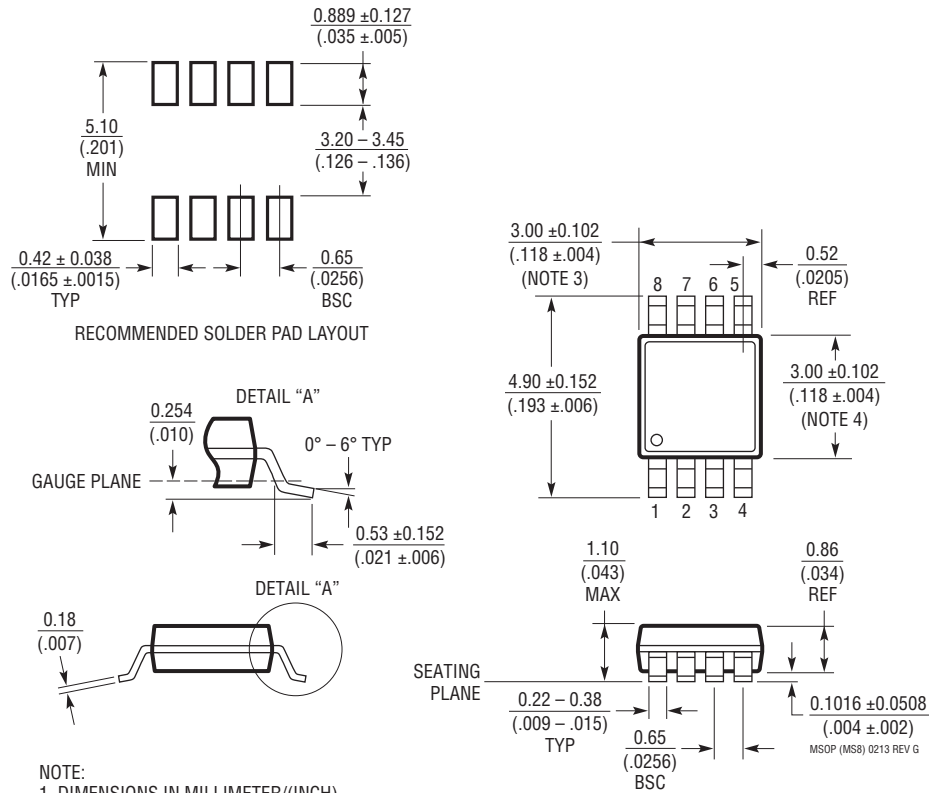

NOTE:

1. DIMENSIONS IN MILLIMETER/(INCH)
2. DRAWING NOT TO SCALE
3. DIMENSION DOES NOT INCLUDE MOLD FLASH, PROTRUSIONS OR GATE BURRS.
MOLD FLASH, PROTRUSIONS OR GATE BURRS SHALL NOT EXCEED 0.152mm (.006") PER SIDE
4. DIMENSION DOES NOT INCLUDE INTERLEAD FLASH OR PROTRUSIONS.
INTERLEAD FLASH OR PROTRUSIONS SHALL NOT EXCEED 0.152mm (.006") PER SIDE
5. LEAD COPLANARITY (BOTTOM OF LEADS AFTER FORMING) SHALL BE 0.102mm (.004") MAX

PACKAGE DESCRIPTION

DD Package
10-Lead Plastic DFN (3mm × 3mm)
 (Reference LTC DWG # 05-08-1699 Rev C)

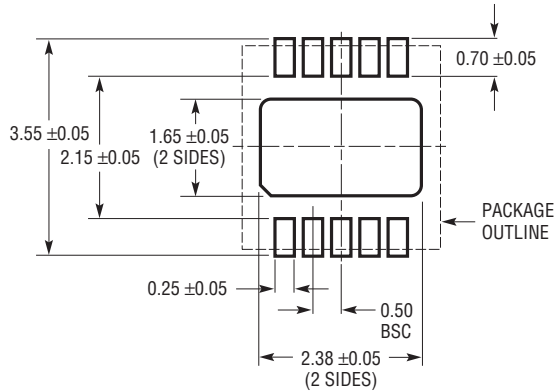

RECOMMENDED SOLDER PAD PITCH AND DIMENSIONS

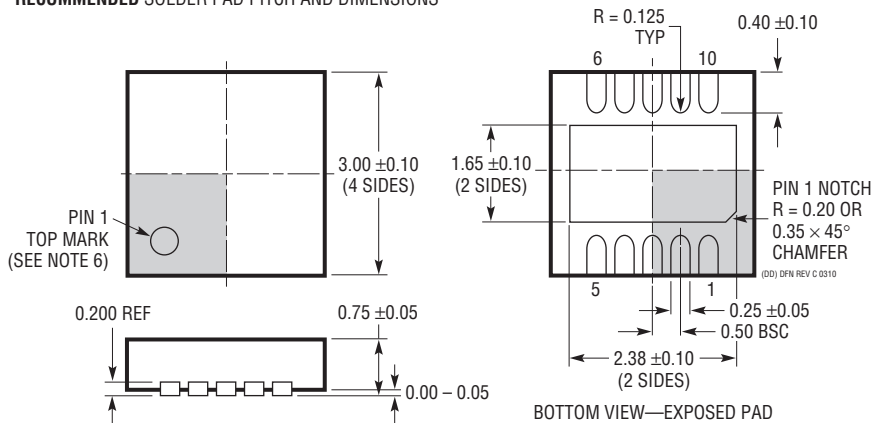

NOTE:

1. DRAWING TO BE MADE A JEDEC PACKAGE OUTLINE M0-229 VARIATION OF (WEED-2). CHECK THE LTC WEBSITE DATA SHEET FOR CURRENT STATUS OF VARIATION ASSIGNMENT
2. DRAWING NOT TO SCALE
3. ALL DIMENSIONS ARE IN MILLIMETERS
4. DIMENSIONS OF EXPOSED PAD ON BOTTOM OF PACKAGE DO NOT INCLUDE MOLD FLASH. MOLD FLASH, IF PRESENT, SHALL NOT EXCEED 0.15mm ON ANY SIDE
5. EXPOSED PAD SHALL BE SOLDER PLATED
6. SHADED AREA IS ONLY A REFERENCE FOR PIN 1 LOCATION ON THE TOP AND BOTTOM OF PACKAGE

REVISION HISTORY

REV	DATE	DESCRIPTION	PAGE NUMBER
A	07/18	Adding LTC2067 to data sheet	All Pages

TYPICAL APPLICATION

Battery Powered Current Sense Amplifier Floats with Sense Resistor Voltage

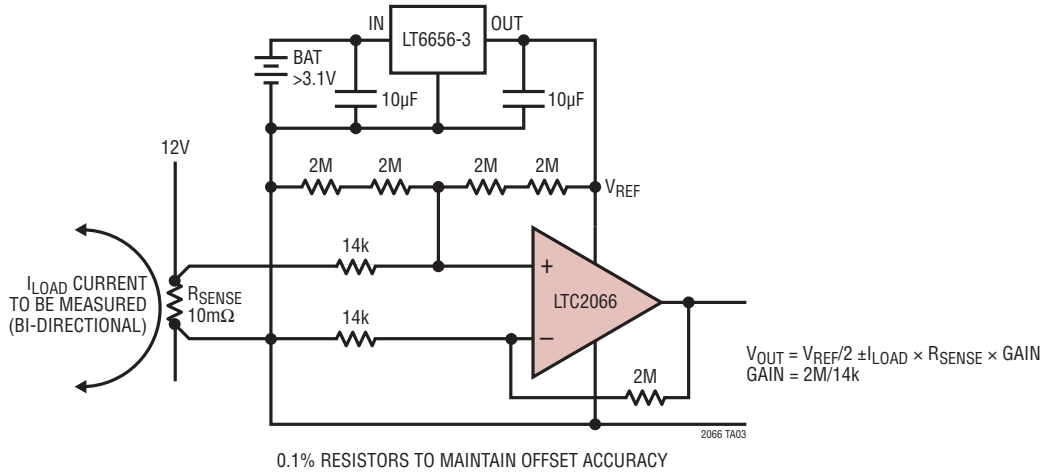

RELATED PARTS

PART NUMBER	DESCRIPTION	COMMENTS
LT1494/LT1495/LT1496	1.5μA Max, Over-The-Top Precision Rail-to-Rail Input and Output Op Amps	375μV V _{OS} , 1.5μA I _S , 2.2V to 36V V _S , 2.7kHz, RRIO
LT6003/LT6004/LT6005	1.6V, 1μA Precision Rail-to-Rail Input and Output Op Amps	500μV V _{OS} , 1μA I _S , 1.6V to 16V V _S , 2kHz, RRIO
LTC2063/LTC2064	2μA, Low I _B , Zero-Drift Operational Amplifiers	5μV V _{OS} , 2μA I _S , 1.7V to 5.25V V _S , 20kHz, RRIO
ADA4051-1/ADA4051-2	Micropower, Single/Dual, Zero-Drift Operational Amplifier	15μV V _{OS} , 17μA I _S , 1.8V to 5.5V V _S , 115kHz, RRIO
LT6023	Micropower, Enhanced Slew Op Amp	20μV V _{OS} , 20μA I _S , 3V to 30V V _S , 40kHz
LTC2054/LTC2055	Micropower, Single/Dual, Zero-Drift Operational Amplifier	5μV V _{OS} , 130μA I _S , 2.7V to 11V V _S , 500kHz, RR Output
LTC2057/LTC2057HV	High Voltage-Low Noise Zero-Drift Operational Amplifier	4μV V _{OS} , 1.2mA I _S , 4.75V to 60V V _S , 1.5MHz, RR Output
LTC2050/LTC2050HV	Zero-Drift Operational Amplifier	3μV V _{OS} , 1.5mA I _S , 2.7V to 12V V _S , 3MHz, RR Output
LTC2051/LTC2052	Dual/Quad, Zero-Drift Operational Amplifier	3μV V _{OS} , 1.5mA I _S , 2.7V to 12V V _S , 3MHz, RR Output
LTC2053	Precision, Rail-to-Rail, Zero-Drift, Resistor-Programmable Instrumentation Amplifier	10μV V _{OS} , 1.3mA I _S , 2.7V to 12V V _S , 200kHz, RRIO
LT5400	Quad Matched Resistor Network	0.01% Matching, 8ppm/°C Temp Drift, 0.2ppm/°C Temp Matching
AD7170	12-Bit Low Power Σ-Δ ADC	130μA in Conversion Mode, 5μA in Shutdown
LTC5800	SmartMesh® Wireless Sensor Network IC	Wireless Mesh Networks
LT6656	850nA Precision Voltage Reference	850nA, 10ppm/°C Temp Drift, 0.05% Accuracy, SOT-23 Package