

Telpower® High Current Switch

TPHCS

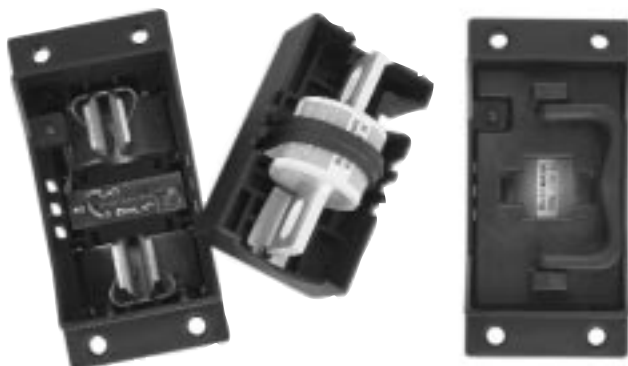

TPHCS800-MAV (shown)

TPHCS

Telpower® High Current Switch

For use with Telpower® Fuses Type TPL-B AND TPL-C.

Patents Pending

Ampere Ratings: 70 to 800 Amperes

Voltage Rating: 80 Volts DC

U.L. Withstand Rating: 100,000A

Agency Information:

U.L. Recognized (investigated to U.L. 1801) as a disconnect switch for the interruption of load current by means of withdrawing the fuse carrier.

U.L. Recognized to meet the requirements for Canadian Standards.

General Information:

- Innovative new design eliminates need for tools to replace the Telpower® type TPL-B or TPL-C fuse.
- Easy to install—captive fasteners allow for direct busbar mounting (bolts not included).
- Optional new electronic alarm provides both local and remote open-fuse indications.
 - Bipolar alarm designed for both Central Office and Radio applications.
 - Local LED alarm indication for ease-of-viewing.
 - Standard ¼" male quick-connect terminal for effortless remote alarm connection (Maximum remote alarm current: 20mA).
 - Eliminates need for parallel indicating fuses.
- Fuse presence window allows for easy viewing of installed fuse ampere rating.
- Compact design for today's high power, high-density cabinets.
- Available as complete switch or pullout and base may be purchased separately.

Part Number System—Switches (Pullout and Base)

To identify part number, replace block with appropriate suffix to identify amperage, thread type, and alarm option.



Amperage (select one)

250 - For Use With 70 to 250 Amp Type TPL-B Fuses

800 - For Use With 300 to 800 Amp Type TPL-C Fuses

Thread (select one)

M - Metric, M8 x 1.25

E - English, 5/16 - 18

Alarm (leave blank for non-alarming version)

L - LED Only, Requires Input From Customer Alarm Circuit

*AV - Alarm, System Voltage

*Consult factory for availability

Part Number System—Bases

To identify part number, replace block with appropriate suffix to identify thread type, and alarm option.

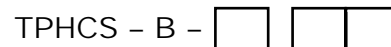

Thread (select one)

M - Metric, M8 x 1.25

E - English, 5/16 - 18

Alarm (leave blank for non-alarming version)

L - LED Only, Requires Input From Customer Alarm Circuit

*AV - Alarm, System Voltage

*Consult factory for availability

| Catalog Numbers-Switches (Pullout and Base) | Series Fuse | Ampere Rating |
|--|-------------|----------------|
| TPHCS250-M High Current Switch, Metric | TPL-B | 70 to 250 Amp |
| TPHCS250-E High Current Switch, English | TPL-B | 70 to 250 Amp |
| TPHCS250-ML High Current Switch, Metric, LED | TPL-B | 70 to 250 Amp |
| TPHCS250-EL High Current Switch, English, LED | TPL-B | 70 to 250 Amp |
| TPHCS250-MAV High Current Switch, Metric, Alarm | TPL-B | 70 to 250 Amp |
| TPHCS250-EAV High Current Switch, English, Alarm | TPL-B | 70 to 250 Amp |
| TPHCS800-M High Current Switch, Metric | TPL-C | 300 to 800 Amp |
| TPHCS800-E High Current Switch, English | TPL-C | 300 to 800 Amp |
| TPHCS800-ML High Current Switch, Metric, LED | TPL-C | 300 to 800 Amp |
| TPHCS800-EL High Current Switch, English, LED | TPL-C | 300 to 800 Amp |
| TPHCS800-MAV High Current Switch, Metric, Alarm | TPL-C | 300 to 800 Amp |
| TPHCS800-EAV High Current Switch, English, Alarm | TPL-C | 300 to 800 Amp |

| Catalog Numbers - Components | Series Fuse | Ampere Rating |
|---------------------------------------|-------------|----------------|
| TPHCS250-P Pullout only - 250 A | TPL-B | 70 to 250 Amp |
| TPHCS800-P Pullout only - 800 A | TPL-C | 300 to 800 Amp |
| TPHCS-B-M Base only, Metric | — | 800 Amp Max. |
| TPHCS-B-E Base only, English | — | 800 Amp Max. |
| TPHCS-B-ML Base only, Metric, LED | — | 800 Amp Max. |
| TPHCS-B-EL Base only, English, LED | — | 800 Amp Max. |
| TPHCS-B-MAV Base only, Metric, Alarm | — | 800 Amp Max. |
| TPHCS-B-EAV Base only, English, Alarm | — | 800 Amp Max. |

Telpower® High Current Switch

TPHCS

TPHCS □ -M & -E

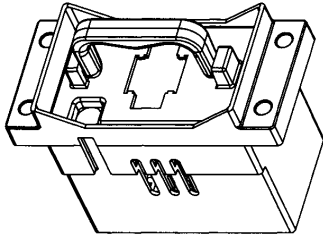

NOTE:
1. TPHCS -M and -E are the same with the exception of thread type.

TPHCS □ -ML & -EL

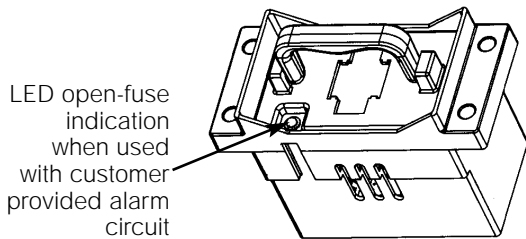

LED open-fuse indication when used with customer provided alarm circuit

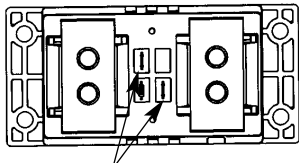

BOTTOM VIEW

LED alarm connections 1/4" male quick connects.

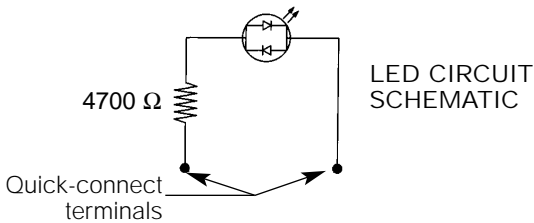

NOTES: 1. TPHCS -ML & -EL are the same with the exception of thread type.
2. Maximum continuous LED current 20mA.

TPHCS-Dimensional Data

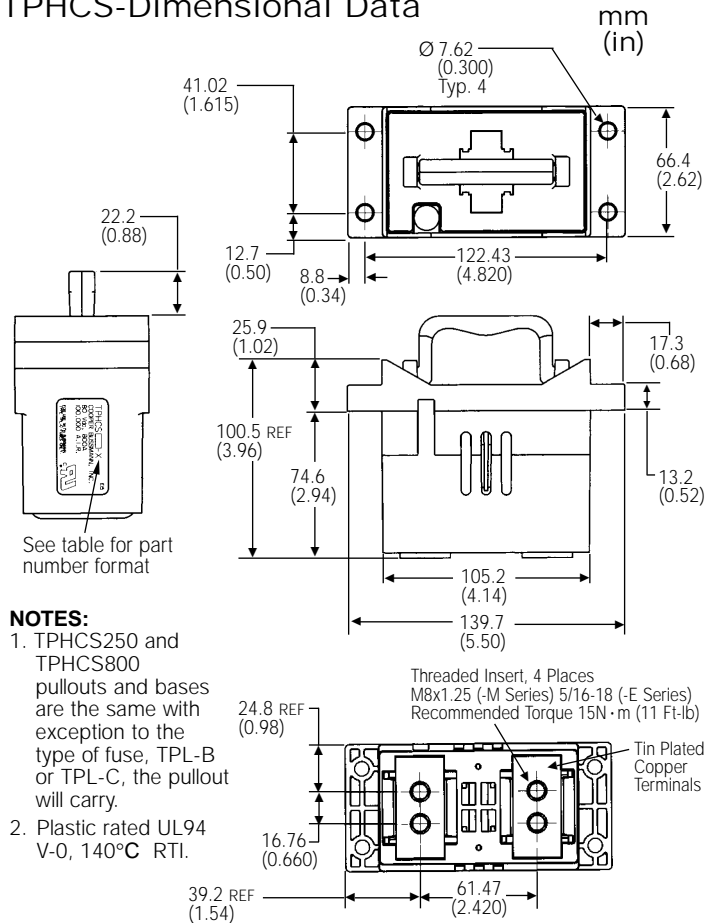

TPHCS COMPONENTS

See Catalog Numbers for complete list

PULLOUTS

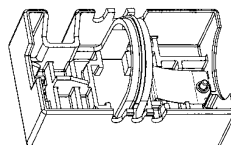

TPHCS800-P

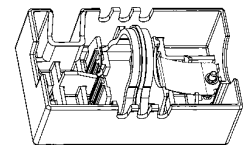

TPHCS250-P

BASES

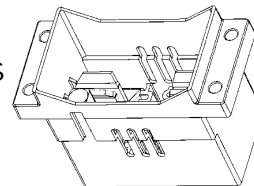

TPHCS-B-M (shown for reference)

The only controlled copy of this BIF document is the electronic read-only version located on the Bussmann Network Drive. All other copies of this BIF document are by definition uncontrolled. This bulletin is intended to clearly present comprehensive product data and provide technical information that will help the end user with design applications. Bussmann reserves the right, without notice, to change design or construction of any products and to discontinue or limit distribution of any products. Bussmann also reserves the right to change or update, without notice, any technical information contained in this bulletin. Once a product has been selected, it should be tested by the user in all possible applications.