

# 74HC4053-Q100; 74HCT4053-Q100

Triple 2-channel analog multiplexer/demultiplexer

Rev. 3 — 5 March 2020

Product data sheet

## 1. General description

---

The 74HC4053-Q100; 74HCT4053-Q100 is a triple single-pole double-throw analog switch (3x SPDT) suitable for use in analog or digital 2:1 multiplexer/demultiplexer applications. Each switch features a digital select input (Sn), two independent inputs/outputs (nY0 and nY1) and a common input/output (nZ). A digital enable input (E) is common to all switches. When  $\bar{E}$  is HIGH, the switches are turned off. Inputs include clamp diodes. This enables the use of current limiting resistors to interface inputs to voltages in excess of  $V_{CC}$ .

This product has been qualified to the Automotive Electronics Council (AEC) standard Q100 (Grade 1) and is suitable for use in automotive applications.

## 2. Features and benefits

---

- Automotive product qualification in accordance with AEC-Q100 (Grade 1)
  - Specified from -40 °C to +85 °C and from -40 °C to +125 °C
- Wide analog input voltage range from -5 V to +5 V
- Low ON resistance:
  - 80  $\Omega$  (typical) at  $V_{CC} - V_{EE} = 4.5$  V
  - 70  $\Omega$  (typical) at  $V_{CC} - V_{EE} = 6.0$  V
  - 60  $\Omega$  (typical) at  $V_{CC} - V_{EE} = 9.0$  V
- Logic level translation: to enable 5 V logic to communicate with  $\pm 5$  V analog signals
- Typical 'break before make' built-in
- ESD protection:
  - MIL-STD-883, method 3015 exceeds 2000 V
  - HBM JESD22-A114F exceeds 2000 V
  - MM JESD22-A115-A exceeds 200 V (C = 200 pF, R = 0  $\Omega$ )
  - CDM AEC-Q100-011 revision B exceeds 1000 V
- Multiple package options
- DHVQFN package with Side-Wettable Flanks enabling Automatic Optical Inspection (AOI) of solder joints

## 3. Applications

---

- Analog multiplexing and demultiplexing
- Digital multiplexing and demultiplexing
- Signal gating

### 4. Ordering information

Table 1. Ordering information

Type number	Package			Version
	Temperature range	Name	Description	
74HC4053D-Q100	-40 °C to +125 °C	SO16	plastic small outline package; 16 leads; body width 3.9 mm	SOT109-1
74HCT4053D-Q100				
74HC4053PW-Q100	-40 °C to +125 °C	TSSOP16	plastic thin shrink small outline package; 16 leads; body width 4.4 mm	SOT403-1
74HCT4053PW-Q100				
74HC4053BQ-Q100	-40 °C to +125 °C	DHVQFN16	plastic dual in-line compatible thermal enhanced very thin quad flat package; no leads; 16 terminals; body 2.5 × 3.5 × 0.85 mm	SOT763-1
74HCT4053BQ-Q100				

### 5. Functional diagram

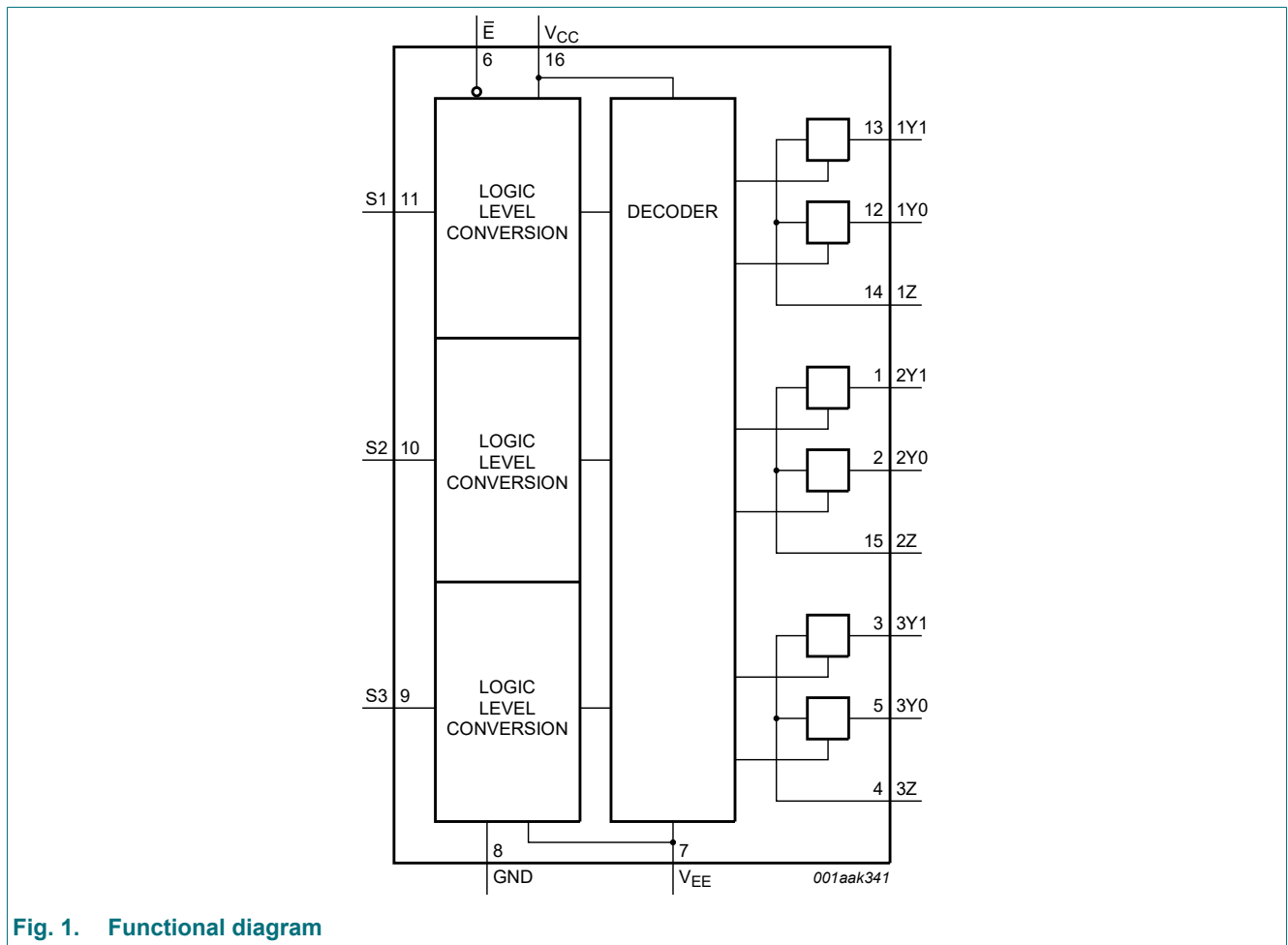

Fig. 1. Functional diagram



Fig. 2. Logic symbol

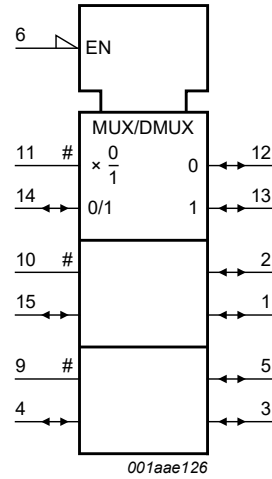

Fig. 3. IEC logic symbol



Fig. 4. Schematic diagram (one switch)

## 6. Pinning information

### 6.1. Pinning

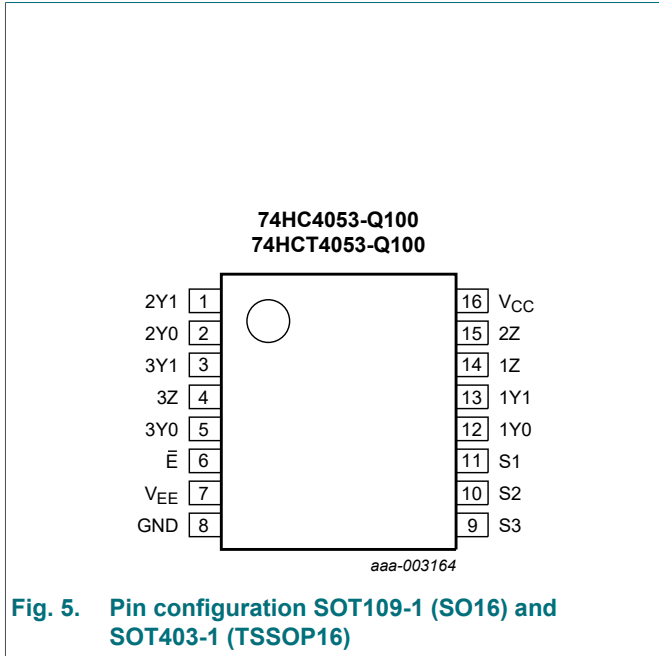

Fig. 5. Pin configuration SOT109-1 (SO16) and SOT403-1 (TSSOP16)

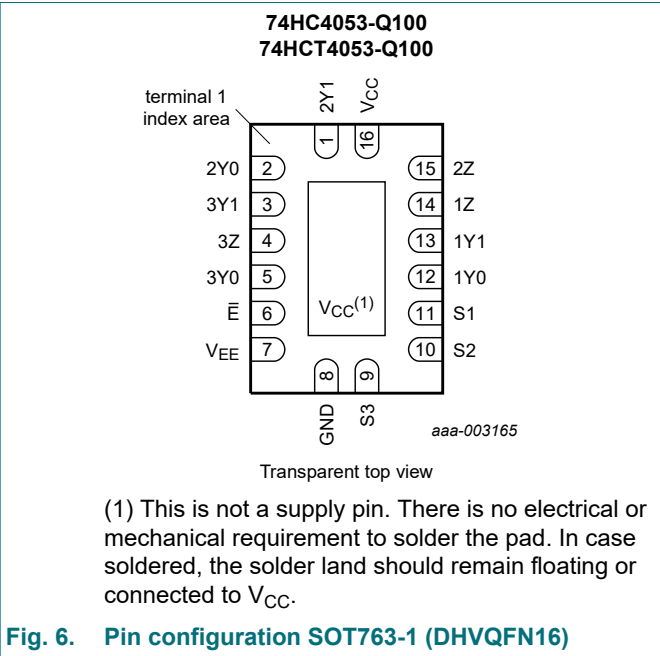

Fig. 6. Pin configuration SOT763-1 (DHVQFN16)

### 6.2. Pin description

Table 2. Pin description

Symbol	Pin	Description
E̅	6	enable input (active LOW)
V <sub>EE</sub>	7	supply voltage
GND	8	ground supply voltage
S1, S2, S3	11, 10, 9	select input
1Y0, 2Y0, 3Y0	12, 2, 5	independent input or output
1Y1, 2Y1, 3Y1	13, 1, 3	independent input or output
1Z, 2Z, 3Z	14, 15, 4	common output or input
V <sub>CC</sub>	16	supply voltage

## 7. Functional description

Table 3. Function table

H = HIGH voltage level; L = LOW voltage level; X = don't care.

Inputs		Channel on
E̅	S <sub>n</sub>	
L	L	nY0 to nZ
L	H	nY1 to nZ
H	X	switches off

## 8. Limiting values

**Table 4. Limiting values**

In accordance with the Absolute Maximum Rating System (IEC 60134). Voltages are referenced to  $V_{SS} = 0\text{ V}$  (ground).

Symbol	Parameter	Conditions	Min	Max	Unit
$V_{CC}$	supply voltage	[1]	-0.5	+11.0	V
$I_{IK}$	input clamping current	$V_I < -0.5\text{ V}$ or $V_I > V_{CC} + 0.5\text{ V}$	-	$\pm 20$	mA
$I_{SK}$	switch clamping current	$V_{SW} < -0.5\text{ V}$ or $V_{SW} > V_{CC} + 0.5\text{ V}$	-	$\pm 20$	mA
$I_{SW}$	switch current	$-0.5\text{ V} < V_{SW} < V_{CC} + 0.5\text{ V}$	-	$\pm 25$	mA
$I_{EE}$	supply current		-	$\pm 20$	mA
$I_{CC}$	supply current		-	50	mA
$I_{GND}$	ground current		-	-50	mA
$T_{stg}$	storage temperature		-65	+150	$^{\circ}\text{C}$
$P_{tot}$	total power dissipation	[2]	-	500	mW
$P$	power dissipation	per switch	-	100	mW

- [1] To avoid drawing  $V_{CC}$  current out of terminal nZ, when switch current flows into terminals nYn, the voltage drop across the bidirectional switch must not exceed 0.4 V. If the switch current flows into terminal nZ, no  $V_{CC}$  current will flow out of terminals nYn, and in this case there is no limit for the voltage drop across the switch, but the voltages at nYn and nZ may not exceed  $V_{CC}$  or  $V_{EE}$ .
- [2] For SOT109-1 (SO16) package:  $P_{tot}$  derates linearly with 12.4 mW/K above 110  $^{\circ}\text{C}$ .  
 For SOT403-1 (TSSOP16) package:  $P_{tot}$  derates linearly with 8.5 mW/K above 91  $^{\circ}\text{C}$ .  
 For SOT763-1 (DHVQFN16) package:  $P_{tot}$  derates linearly with 11.2 mW/K above 106  $^{\circ}\text{C}$ .

## 9. Recommended operating conditions

**Table 5. Recommended operating conditions**

Symbol	Parameter	Conditions	74HC4053-Q100			74HCT4053-Q100			Unit
			Min	Typ	Max	Min	Typ	Max	
$V_{CC}$	supply voltage	see <a href="#">Fig. 7</a> and <a href="#">Fig. 8</a>							
		$V_{CC} - \text{GND}$	2.0	5.0	10.0	4.5	5.0	5.5	V
		$V_{CC} - V_{EE}$	2.0	5.0	10.0	2.0	5.0	10.0	V
$V_I$	input voltage		GND	-	$V_{CC}$	GND	-	$V_{CC}$	V
$V_{SW}$	switch voltage		$V_{EE}$	-	$V_{CC}$	$V_{EE}$	-	$V_{CC}$	V
$T_{amb}$	ambient temperature		-40	+25	+125	-40	+25	+125	$^{\circ}\text{C}$
$\Delta t/\Delta V$	input transition rise and fall rate	$V_{CC} = 2.0\text{ V}$	-	-	625	-	-	-	ns/V
		$V_{CC} = 4.5\text{ V}$	-	1.67	139	-	1.67	139	ns/V
		$V_{CC} = 6.0\text{ V}$	-	-	83	-	-	-	ns/V
		$V_{CC} = 10.0\text{ V}$	-	-	31	-	-	-	ns/V

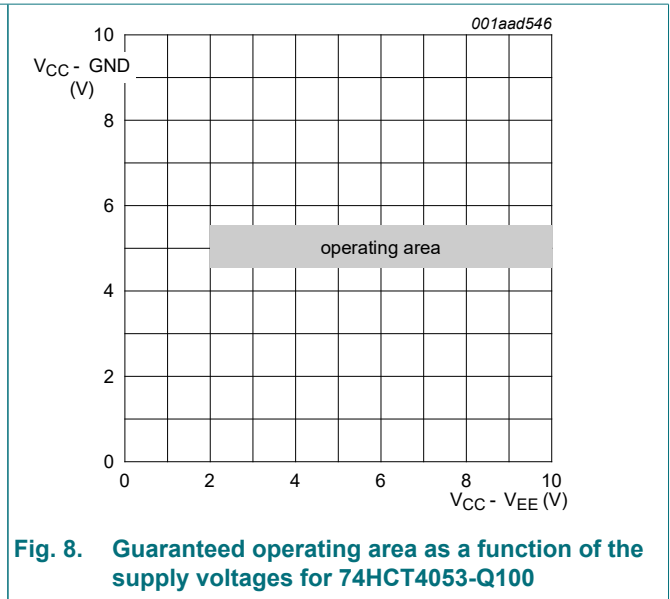

## 10. Static characteristics

**Table 6. RON resistance per switch for 74HC4053-Q100 and 74HCT4053-Q100**

$V_I = V_{IH}$  or  $V_{IL}$ ; for test circuit see Fig. 9.

$V_{is}$  is the input voltage at a nYn or nZ terminal, whichever is assigned as an input.

$V_{os}$  is the output voltage at a nYn or nZ terminal, whichever is assigned as an output.

For 74HC4053-Q100:  $V_{CC} - GND$  or  $V_{CC} - V_{EE} = 2.0\text{ V}$ ,  $4.5\text{ V}$ ,  $6.0\text{ V}$  and  $9.0\text{ V}$ .

For 74HCT4053-Q100:  $V_{CC} - GND = 4.5\text{ V}$  and  $5.5\text{ V}$ ,  $V_{CC} - V_{EE} = 2.0\text{ V}$ ,  $4.5\text{ V}$ ,  $6.0\text{ V}$  and  $9.0\text{ V}$ .

Symbol	Parameter	Conditions	Min	Typ	Max	Unit	
<b>T<sub>amb</sub> = 25 °C</b>							
R <sub>ON(peak)</sub>	ON resistance (peak)	$V_{is} = V_{CC}$ to $V_{EE}$					
		$V_{CC} = 2.0\text{ V}$ ; $V_{EE} = 0\text{ V}$ ; $I_{SW} = 100\text{ }\mu\text{A}$	[1]	-	-	-	$\Omega$
		$V_{CC} = 4.5\text{ V}$ ; $V_{EE} = 0\text{ V}$ ; $I_{SW} = 1000\text{ }\mu\text{A}$		-	100	180	$\Omega$
		$V_{CC} = 6.0\text{ V}$ ; $V_{EE} = 0\text{ V}$ ; $I_{SW} = 1000\text{ }\mu\text{A}$		-	90	160	$\Omega$
R <sub>ON(rail)</sub>	ON resistance (rail)	$V_{is} = V_{EE}$					
		$V_{CC} = 2.0\text{ V}$ ; $V_{EE} = 0\text{ V}$ ; $I_{SW} = 100\text{ }\mu\text{A}$	[1]	-	150	-	$\Omega$
		$V_{CC} = 4.5\text{ V}$ ; $V_{EE} = 0\text{ V}$ ; $I_{SW} = 1000\text{ }\mu\text{A}$		-	80	140	$\Omega$
		$V_{CC} = 6.0\text{ V}$ ; $V_{EE} = 0\text{ V}$ ; $I_{SW} = 1000\text{ }\mu\text{A}$		-	70	120	$\Omega$
		$V_{CC} = 4.5\text{ V}$ ; $V_{EE} = -4.5\text{ V}$ ; $I_{SW} = 1000\text{ }\mu\text{A}$		-	60	105	$\Omega$
		$V_{is} = V_{CC}$					
		$V_{CC} = 2.0\text{ V}$ ; $V_{EE} = 0\text{ V}$ ; $I_{SW} = 100\text{ }\mu\text{A}$	[1]	-	150	-	$\Omega$
		$V_{CC} = 4.5\text{ V}$ ; $V_{EE} = 0\text{ V}$ ; $I_{SW} = 1000\text{ }\mu\text{A}$		-	90	160	$\Omega$
$\Delta R_{ON}$	ON resistance mismatch between channels	$V_{is} = V_{CC}$ to $V_{EE}$					
		$V_{CC} = 2.0\text{ V}$ ; $V_{EE} = 0\text{ V}$	[1]	-	-	-	$\Omega$
		$V_{CC} = 4.5\text{ V}$ ; $V_{EE} = 0\text{ V}$		-	9	-	$\Omega$
		$V_{CC} = 6.0\text{ V}$ ; $V_{EE} = 0\text{ V}$		-	8	-	$\Omega$
		$V_{CC} = 4.5\text{ V}$ ; $V_{EE} = -4.5\text{ V}$		-	6	-	$\Omega$

Symbol	Parameter	Conditions	Min	Typ	Max	Unit	
<b>T<sub>amb</sub> = -40 °C to +85 °C</b>							
R <sub>ON(peak)</sub>	ON resistance (peak)	V <sub>is</sub> = V <sub>CC</sub> to V <sub>EE</sub>					
		V <sub>CC</sub> = 2.0 V; V <sub>EE</sub> = 0 V; I <sub>SW</sub> = 100 μA	[1]	-	-	-	Ω
		V <sub>CC</sub> = 4.5 V; V <sub>EE</sub> = 0 V; I <sub>SW</sub> = 1000 μA		-	-	225	Ω
		V <sub>CC</sub> = 6.0 V; V <sub>EE</sub> = 0 V; I <sub>SW</sub> = 1000 μA		-	-	200	Ω
		V <sub>CC</sub> = 4.5 V; V <sub>EE</sub> = -4.5 V; I <sub>SW</sub> = 1000 μA		-	-	165	Ω
R <sub>ON(rail)</sub>	ON resistance (rail)	V <sub>is</sub> = V <sub>EE</sub>					
		V <sub>CC</sub> = 2.0 V; V <sub>EE</sub> = 0 V; I <sub>SW</sub> = 100 μA	[1]	-	-	-	Ω
		V <sub>CC</sub> = 4.5 V; V <sub>EE</sub> = 0 V; I <sub>SW</sub> = 1000 μA		-	-	175	Ω
		V <sub>CC</sub> = 6.0 V; V <sub>EE</sub> = 0 V; I <sub>SW</sub> = 1000 μA		-	-	150	Ω
		V <sub>CC</sub> = 4.5 V; V <sub>EE</sub> = -4.5 V; I <sub>SW</sub> = 1000 μA		-	-	130	Ω
		V <sub>is</sub> = V <sub>CC</sub>					
		V <sub>CC</sub> = 2.0 V; V <sub>EE</sub> = 0 V; I <sub>SW</sub> = 100 μA	[1]	-	-	-	Ω
		V <sub>CC</sub> = 4.5 V; V <sub>EE</sub> = 0 V; I <sub>SW</sub> = 1000 μA		-	-	200	Ω
		V <sub>CC</sub> = 6.0 V; V <sub>EE</sub> = 0 V; I <sub>SW</sub> = 1000 μA		-	-	175	Ω
		V <sub>CC</sub> = 4.5 V; V <sub>EE</sub> = -4.5 V; I <sub>SW</sub> = 1000 μA		-	-	150	Ω
<b>T<sub>amb</sub> = -40 °C to +125 °C</b>							
R <sub>ON(peak)</sub>	ON resistance (peak)	V <sub>is</sub> = V <sub>CC</sub> to V <sub>EE</sub>					
		V <sub>CC</sub> = 2.0 V; V <sub>EE</sub> = 0 V; I <sub>SW</sub> = 100 μA	[1]	-	-	-	Ω
		V <sub>CC</sub> = 4.5 V; V <sub>EE</sub> = 0 V; I <sub>SW</sub> = 1000 μA		-	-	270	Ω
		V <sub>CC</sub> = 6.0 V; V <sub>EE</sub> = 0 V; I <sub>SW</sub> = 1000 μA		-	-	240	Ω
		V <sub>CC</sub> = 4.5 V; V <sub>EE</sub> = -4.5 V; I <sub>SW</sub> = 1000 μA		-	-	195	Ω
R <sub>ON(rail)</sub>	ON resistance (rail)	V <sub>is</sub> = V <sub>EE</sub>					
		V <sub>CC</sub> = 2.0 V; V <sub>EE</sub> = 0 V; I <sub>SW</sub> = 100 μA	[1]	-	-	-	Ω
		V <sub>CC</sub> = 4.5 V; V <sub>EE</sub> = 0 V; I <sub>SW</sub> = 1000 μA		-	-	210	Ω
		V <sub>CC</sub> = 6.0 V; V <sub>EE</sub> = 0 V; I <sub>SW</sub> = 1000 μA		-	-	180	Ω
		V <sub>CC</sub> = 4.5 V; V <sub>EE</sub> = -4.5 V; I <sub>SW</sub> = 1000 μA		-	-	160	Ω
		V <sub>is</sub> = V <sub>CC</sub>					
		V <sub>CC</sub> = 2.0 V; V <sub>EE</sub> = 0 V; I <sub>SW</sub> = 100 μA	[1]	-	-	-	Ω
		V <sub>CC</sub> = 4.5 V; V <sub>EE</sub> = 0 V; I <sub>SW</sub> = 1000 μA		-	-	240	Ω
		V <sub>CC</sub> = 6.0 V; V <sub>EE</sub> = 0 V; I <sub>SW</sub> = 1000 μA		-	-	210	Ω
		V <sub>CC</sub> = 4.5 V; V <sub>EE</sub> = -4.5 V; I <sub>SW</sub> = 1000 μA		-	-	180	Ω

[1] When supply voltages (V<sub>CC</sub> - V<sub>EE</sub>) near 2.0 V the analog switch ON resistance becomes extremely non-linear. When using a supply of 2 V, it is recommended to use these devices only for transmitting digital signals.



Fig. 9. Test circuit for measuring  $R_{ON}$



Fig. 10. Typical  $R_{ON}$  as a function of input voltage  $V_{is}$

Table 7. Static characteristics for 74HC4053-Q100

Voltages are referenced to GND (ground = 0 V).

$V_{is}$  is the input voltage at pins nYn or nZ, whichever is assigned as an input.

$V_{os}$  is the output voltage at pins nZ or nYn, whichever is assigned as an output.

Symbol	Parameter	Conditions	Min	Typ	Max	Unit
<b><math>T_{amb} = 25 \text{ }^\circ\text{C}</math></b>						
$V_{IH}$	HIGH-level input voltage	$V_{CC} = 2.0 \text{ V}$	1.5	1.2	-	V
		$V_{CC} = 4.5 \text{ V}$	3.15	2.4	-	V
		$V_{CC} = 6.0 \text{ V}$	4.2	3.2	-	V
		$V_{CC} = 9.0 \text{ V}$	6.3	4.7	-	V
$V_{IL}$	LOW-level input voltage	$V_{CC} = 2.0 \text{ V}$	-	0.8	0.5	V
		$V_{CC} = 4.5 \text{ V}$	-	2.1	1.35	V
		$V_{CC} = 6.0 \text{ V}$	-	2.8	1.8	V
		$V_{CC} = 9.0 \text{ V}$	-	4.3	2.7	V
$I_I$	input leakage current	$V_{EE} = 0 \text{ V}; V_I = V_{CC} \text{ or } \text{GND}$				
		$V_{CC} = 6.0 \text{ V}$	-	-	$\pm 0.1$	$\mu\text{A}$
		$V_{CC} = 10.0 \text{ V}$	-	-	$\pm 0.2$	$\mu\text{A}$
$I_{S(OFF)}$	OFF-state leakage current	$V_{CC} = 10.0 \text{ V}; V_{EE} = 0 \text{ V}; V_I = V_{IH} \text{ or } V_{IL};  V_{SW}  = V_{CC} - V_{EE};$ see Fig. 11				
		per channel	-	-	$\pm 0.1$	$\mu\text{A}$
		all channels	-	-	$\pm 0.1$	$\mu\text{A}$
$I_{S(ON)}$	ON-state leakage current	$V_{CC} = 10.0 \text{ V}; V_{EE} = 0 \text{ V}; V_I = V_{IH} \text{ or } V_{IL};  V_{SW}  = V_{CC} - V_{EE};$ see Fig. 12	-	-	$\pm 0.1$	$\mu\text{A}$
$I_{CC}$	supply current	$V_{EE} = 0 \text{ V}; V_I = V_{CC} \text{ or } \text{GND}; V_{is} = V_{EE} \text{ or } V_{CC}; V_{os} = V_{CC} \text{ or } V_{EE}$				
		$V_{CC} = 6.0 \text{ V}$	-	-	8.0	$\mu\text{A}$
		$V_{CC} = 10.0 \text{ V}$	-	-	16.0	$\mu\text{A}$
$C_I$	input capacitance		-	3.5	-	pF



Symbol	Parameter	Conditions	Min	Typ	Max	Unit
$C_{sw}$	switch capacitance	independent pins nYn	-	5	-	pF
		common pins nZ	-	8	-	pF
<b><math>T_{amb} = -40\text{ °C to }+85\text{ °C}</math></b>						
$V_{IH}$	HIGH-level input voltage	$V_{CC} = 2.0\text{ V}$	1.5	-	-	V
		$V_{CC} = 4.5\text{ V}$	3.15	-	-	V
		$V_{CC} = 6.0\text{ V}$	4.2	-	-	V
		$V_{CC} = 9.0\text{ V}$	6.3	-	-	V
$V_{IL}$	LOW-level input voltage	$V_{CC} = 2.0\text{ V}$	-	-	0.5	V
		$V_{CC} = 4.5\text{ V}$	-	-	1.35	V
		$V_{CC} = 6.0\text{ V}$	-	-	1.8	V
		$V_{CC} = 9.0\text{ V}$	-	-	2.7	V
$I_I$	input leakage current	$V_{EE} = 0\text{ V}; V_I = V_{CC}\text{ or GND}$				
		$V_{CC} = 6.0\text{ V}$	-	-	$\pm 1.0$	$\mu\text{A}$
		$V_{CC} = 10.0\text{ V}$	-	-	$\pm 2.0$	$\mu\text{A}$
$I_{S(OFF)}$	OFF-state leakage current	$V_{CC} = 10.0\text{ V}; V_{EE} = 0\text{ V}; V_I = V_{IH}\text{ or }V_{IL};  V_{SW}  = V_{CC} - V_{EE}; \text{ Fig. 11}$				
		per channel	-	-	$\pm 1.0$	$\mu\text{A}$
		all channels	-	-	$\pm 1.0$	$\mu\text{A}$
$I_{S(ON)}$	ON-state leakage current	$V_{CC} = 10.0\text{ V}; V_{EE} = 0\text{ V}; V_I = V_{IH}\text{ or }V_{IL};  V_{SW}  = V_{CC} - V_{EE}; \text{ see Fig. 12}$	-	-	$\pm 1.0$	$\mu\text{A}$
$I_{CC}$	supply current	$V_{EE} = 0\text{ V}; V_I = V_{CC}\text{ or GND}; V_{is} = V_{EE}\text{ or }V_{CC}; V_{os} = V_{CC}\text{ or }V_{EE}$				
		$V_{CC} = 6.0\text{ V}$	-	-	80.0	$\mu\text{A}$
		$V_{CC} = 10.0\text{ V}$	-	-	160.0	$\mu\text{A}$
<b><math>T_{amb} = -40\text{ °C to }+125\text{ °C}</math></b>						
$V_{IH}$	HIGH-level input voltage	$V_{CC} = 2.0\text{ V}$	1.5	-	-	V
		$V_{CC} = 4.5\text{ V}$	3.15	-	-	V
		$V_{CC} = 6.0\text{ V}$	4.2	-	-	V
		$V_{CC} = 9.0\text{ V}$	6.3	-	-	V
$V_{IL}$	LOW-level input voltage	$V_{CC} = 2.0\text{ V}$	-	-	0.5	V
		$V_{CC} = 4.5\text{ V}$	-	-	1.35	V
		$V_{CC} = 6.0\text{ V}$	-	-	1.8	V
		$V_{CC} = 9.0\text{ V}$	-	-	2.7	V
$I_I$	input leakage current	$V_{EE} = 0\text{ V}; V_I = V_{CC}\text{ or GND}$				
		$V_{CC} = 6.0\text{ V}$	-	-	$\pm 1.0$	$\mu\text{A}$
		$V_{CC} = 10.0\text{ V}$	-	-	$\pm 2.0$	$\mu\text{A}$
$I_{S(OFF)}$	OFF-state leakage current	$V_{CC} = 10.0\text{ V}; V_{EE} = 0\text{ V}; V_I = V_{IH}\text{ or }V_{IL};  V_{SW}  = V_{CC} - V_{EE}; \text{ see Fig. 11}$				
		per channel	-	-	$\pm 1.0$	$\mu\text{A}$
		all channels	-	-	$\pm 1.0$	$\mu\text{A}$
$I_{S(ON)}$	ON-state leakage current	$V_{CC} = 10.0\text{ V}; V_{EE} = 0\text{ V}; V_I = V_{IH}\text{ or }V_{IL};  V_{SW}  = V_{CC} - V_{EE}; \text{ see Fig. 12}$	-	-	$\pm 1.0$	$\mu\text{A}$

Symbol	Parameter	Conditions	Min	Typ	Max	Unit
I <sub>CC</sub>	supply current	V <sub>EE</sub> = 0 V; V <sub>I</sub> = V <sub>CC</sub> or GND; V <sub>is</sub> = V <sub>EE</sub> or V <sub>CC</sub> ; V <sub>os</sub> = V <sub>CC</sub> or V <sub>EE</sub>				
		V <sub>CC</sub> = 6.0 V	-	-	160.0	μA
		V <sub>CC</sub> = 10.0 V	-	-	320.0	μA

**Table 8. Static characteristics for 74HCT4053-Q100**

Voltages are referenced to GND (ground = 0 V).

V<sub>is</sub> is the input voltage at pins nYn or nZ, whichever is assigned as an input.

V<sub>os</sub> is the output voltage at pins nZ or nYn, whichever is assigned as an output.

Symbol	Parameter	Conditions	Min	Typ	Max	Unit
<b>T<sub>amb</sub> = 25 °C</b>						
V <sub>IH</sub>	HIGH-level input voltage	V <sub>CC</sub> = 4.5 V to 5.5 V	2.0	1.6	-	V
V <sub>IL</sub>	LOW-level input voltage	V <sub>CC</sub> = 4.5 V to 5.5 V	-	1.2	0.8	V
I <sub>I</sub>	input leakage current	V <sub>I</sub> = V <sub>CC</sub> or GND; V <sub>CC</sub> = 5.5 V; V <sub>EE</sub> = 0 V	-	-	±0.1	μA
I <sub>S(OFF)</sub>	OFF-state leakage current	V <sub>CC</sub> = 10.0 V; V <sub>EE</sub> = 0 V; V <sub>I</sub> = V <sub>IH</sub> or V <sub>IL</sub> ;  V <sub>SW</sub>   = V <sub>CC</sub> - V <sub>EE</sub> ; see Fig. 11				
		per channel	-	-	±0.1	μA
		all channels	-	-	±0.1	μA
I <sub>S(ON)</sub>	ON-state leakage current	V <sub>CC</sub> = 10.0 V; V <sub>EE</sub> = 0 V; V <sub>I</sub> = V <sub>IH</sub> or V <sub>IL</sub> ;  V <sub>SW</sub>   = V <sub>CC</sub> - V <sub>EE</sub> ; see Fig. 12	-	-	±0.1	μA
I <sub>CC</sub>	supply current	V <sub>I</sub> = V <sub>CC</sub> or GND; V <sub>is</sub> = V <sub>EE</sub> or V <sub>CC</sub> ; V <sub>os</sub> = V <sub>CC</sub> or V <sub>EE</sub>				
		V <sub>CC</sub> = 5.5 V; V <sub>EE</sub> = 0 V	-	-	8.0	μA
		V <sub>CC</sub> = 5.0 V; V <sub>EE</sub> = -5.0 V	-	-	16.0	μA
ΔI <sub>CC</sub>	additional supply current	per input; V <sub>I</sub> = V <sub>CC</sub> - 2.1 V; other inputs at V <sub>CC</sub> or GND; V <sub>CC</sub> = 4.5 V to 5.5 V; V <sub>EE</sub> = 0 V	-	50	180	μA
C <sub>I</sub>	input capacitance		-	3.5	-	pF
C <sub>sw</sub>	switch capacitance	independent pins nYn	-	5	-	pF
		common pins nZ	-	8	-	pF
<b>T<sub>amb</sub> = -40 °C to +85 °C</b>						
V <sub>IH</sub>	HIGH-level input voltage	V <sub>CC</sub> = 4.5 V to 5.5 V	2.0	-	-	V
V <sub>IL</sub>	LOW-level input voltage	V <sub>CC</sub> = 4.5 V to 5.5 V	-	-	0.8	V
I <sub>I</sub>	input leakage current	V <sub>I</sub> = V <sub>CC</sub> or GND; V <sub>CC</sub> = 5.5 V; V <sub>EE</sub> = 0 V	-	-	±1.0	μA
I <sub>S(OFF)</sub>	OFF-state leakage current	V <sub>CC</sub> = 10.0 V; V <sub>EE</sub> = 0 V; V <sub>I</sub> = V <sub>IH</sub> or V <sub>IL</sub> ;  V <sub>SW</sub>   = V <sub>CC</sub> - V <sub>EE</sub> ; see Fig. 11				
		per channel	-	-	±1.0	μA
		all channels	-	-	±1.0	μA
I <sub>S(ON)</sub>	ON-state leakage current	V <sub>CC</sub> = 10.0 V; V <sub>EE</sub> = 0 V; V <sub>I</sub> = V <sub>IH</sub> or V <sub>IL</sub> ;  V <sub>SW</sub>   = V <sub>CC</sub> - V <sub>EE</sub> ; see Fig. 12	-	-	±1.0	μA
I <sub>CC</sub>	supply current	V <sub>I</sub> = V <sub>CC</sub> or GND; V <sub>is</sub> = V <sub>EE</sub> or V <sub>CC</sub> ; V <sub>os</sub> = V <sub>CC</sub> or V <sub>EE</sub>				
		V <sub>CC</sub> = 5.5 V; V <sub>EE</sub> = 0 V	-	-	80.0	μA
		V <sub>CC</sub> = 5.0 V; V <sub>EE</sub> = -5.0 V	-	-	160.0	μA

Symbol	Parameter	Conditions	Min	Typ	Max	Unit
$\Delta I_{CC}$	additional supply current	per input; $V_I = V_{CC} - 2.1\text{ V}$ ; other inputs at $V_{CC}$ or GND; $V_{CC} = 4.5\text{ V to }5.5\text{ V}$ ; $V_{EE} = 0\text{ V}$	-	-	225	$\mu\text{A}$
<b><math>T_{\text{amb}} = -40\text{ }^\circ\text{C to }+125\text{ }^\circ\text{C}</math></b>						
$V_{IH}$	HIGH-level input voltage	$V_{CC} = 4.5\text{ V to }5.5\text{ V}$	2.0	-	-	V
$V_{IL}$	LOW-level input voltage	$V_{CC} = 4.5\text{ V to }5.5\text{ V}$	-	-	0.8	V
$I_I$	input leakage current	$V_I = V_{CC}$ or GND; $V_{CC} = 5.5\text{ V}$ ; $V_{EE} = 0\text{ V}$	-	-	$\pm 1.0$	$\mu\text{A}$
$I_{S(\text{OFF})}$	OFF-state leakage current	$V_{CC} = 10.0\text{ V}$ ; $V_{EE} = 0\text{ V}$ ; $V_I = V_{IH}$ or $V_{IL}$ ; $ V_{\text{SW}}  = V_{CC} - V_{EE}$ ; see Fig. 11				
		per channel	-	-	$\pm 1.0$	$\mu\text{A}$
		all channels	-	-	$\pm 1.0$	$\mu\text{A}$
$I_{S(\text{ON})}$	ON-state leakage current	$V_{CC} = 10.0\text{ V}$ ; $V_{EE} = 0\text{ V}$ ; $V_I = V_{IH}$ or $V_{IL}$ ; $ V_{\text{SW}}  = V_{CC} - V_{EE}$ ; see Fig. 12	-	-	$\pm 1.0$	$\mu\text{A}$
$I_{CC}$	supply current	$V_I = V_{CC}$ or GND; $V_{is} = V_{EE}$ or $V_{CC}$ ; $V_{os} = V_{CC}$ or $V_{EE}$				
		$V_{CC} = 5.5\text{ V}$ ; $V_{EE} = 0\text{ V}$	-	-	160.0	$\mu\text{A}$
		$V_{CC} = 5.0\text{ V}$ ; $V_{EE} = -5.0\text{ V}$	-	-	320.0	$\mu\text{A}$
$\Delta I_{CC}$	additional supply current	per input; $V_I = V_{CC} - 2.1\text{ V}$ ; other inputs at $V_{CC}$ or GND; $V_{CC} = 4.5\text{ V to }5.5\text{ V}$ ; $V_{EE} = 0\text{ V}$	-	-	245	$\mu\text{A}$



## 11. Dynamic characteristics

**Table 9. Dynamic characteristics for 74HC4053-Q100**

$GND = 0\text{ V}$ ;  $t_r = t_f = 6\text{ ns}$ ;  $C_L = 50\text{ pF}$ ; for test circuit see Fig. 15.

$V_{is}$  is the input voltage at a  $nYn$  or  $nZ$  terminal, whichever is assigned as an input.

$V_{os}$  is the output voltage at a  $nYn$  or  $nZ$  terminal, whichever is assigned as an output.

Symbol	Parameter	Conditions	Min	Typ	Max	Unit
<b><math>T_{\text{amb}} = 25\text{ }^\circ\text{C}</math></b>						
$t_{pd}$	propagation delay	$V_{is}$ to $V_{os}$ ; $R_L = \infty\ \Omega$ ; see Fig. 13	[1]			
		$V_{CC} = 2.0\text{ V}$ ; $V_{EE} = 0\text{ V}$	-	15	60	ns
		$V_{CC} = 4.5\text{ V}$ ; $V_{EE} = 0\text{ V}$	-	5	12	ns
		$V_{CC} = 6.0\text{ V}$ ; $V_{EE} = 0\text{ V}$	-	4	10	ns
		$V_{CC} = 4.5\text{ V}$ ; $V_{EE} = -4.5\text{ V}$	-	4	8	ns

Symbol	Parameter	Conditions	Min	Typ	Max	Unit
t <sub>on</sub>	turn-on time	$\bar{E}$ to V <sub>os</sub> ; R <sub>L</sub> = ∞ Ω; see Fig. 14 [2]				
		V <sub>CC</sub> = 2.0 V; V <sub>EE</sub> = 0 V	-	60	220	ns
		V <sub>CC</sub> = 4.5 V; V <sub>EE</sub> = 0 V	-	20	44	ns
		V <sub>CC</sub> = 5.0 V; V <sub>EE</sub> = 0 V; C <sub>L</sub> = 15 pF	-	17	-	ns
		V <sub>CC</sub> = 6.0 V; V <sub>EE</sub> = 0 V	-	16	37	ns
		V <sub>CC</sub> = 4.5 V; V <sub>EE</sub> = -4.5 V	-	15	31	ns
		Sn to V <sub>os</sub> ; R <sub>L</sub> = ∞ Ω; see Fig. 14 [2]				
		V <sub>CC</sub> = 2.0 V; V <sub>EE</sub> = 0 V	-	75	220	ns
		V <sub>CC</sub> = 4.5 V; V <sub>EE</sub> = 0 V	-	25	44	ns
		V <sub>CC</sub> = 5.0 V; V <sub>EE</sub> = 0 V; C <sub>L</sub> = 15 pF	-	21	-	ns
		V <sub>CC</sub> = 6.0 V; V <sub>EE</sub> = 0 V	-	20	37	ns
		V <sub>CC</sub> = 4.5 V; V <sub>EE</sub> = -4.5 V	-	15	31	ns
t <sub>off</sub>	turn-off time	$\bar{E}$ to V <sub>os</sub> ; R <sub>L</sub> = 1 kΩ; see Fig. 14 [3]				
		V <sub>CC</sub> = 2.0 V; V <sub>EE</sub> = 0 V	-	63	210	ns
		V <sub>CC</sub> = 4.5 V; V <sub>EE</sub> = 0 V	-	21	42	ns
		V <sub>CC</sub> = 5.0 V; V <sub>EE</sub> = 0 V; C <sub>L</sub> = 15 pF	-	18	-	ns
		V <sub>CC</sub> = 6.0 V; V <sub>EE</sub> = 0 V	-	17	36	ns
		V <sub>CC</sub> = 4.5 V; V <sub>EE</sub> = -4.5 V	-	15	29	ns
		Sn to V <sub>os</sub> ; R <sub>L</sub> = 1 kΩ; see Fig. 14 [3]				
		V <sub>CC</sub> = 2.0 V; V <sub>EE</sub> = 0 V	-	60	210	ns
		V <sub>CC</sub> = 4.5 V; V <sub>EE</sub> = 0 V	-	20	42	ns
		V <sub>CC</sub> = 5.0 V; V <sub>EE</sub> = 0 V; C <sub>L</sub> = 15 pF	-	17	-	ns
		V <sub>CC</sub> = 6.0 V; V <sub>EE</sub> = 0 V	-	16	36	ns
		V <sub>CC</sub> = 4.5 V; V <sub>EE</sub> = -4.5 V	-	15	29	ns
C <sub>PD</sub>	power dissipation capacitance	per switch; V <sub>I</sub> = GND to V <sub>CC</sub> [4]	-	36	-	pF
<b>T<sub>amb</sub> = -40 °C to +85 °C</b>						
t <sub>pd</sub>	propagation delay	V <sub>is</sub> to V <sub>os</sub> ; R <sub>L</sub> = ∞ Ω; see Fig. 13 [1]				
		V <sub>CC</sub> = 2.0 V; V <sub>EE</sub> = 0 V	-	-	75	ns
		V <sub>CC</sub> = 4.5 V; V <sub>EE</sub> = 0 V	-	-	15	ns
		V <sub>CC</sub> = 6.0 V; V <sub>EE</sub> = 0 V	-	-	13	ns
		V <sub>CC</sub> = 4.5 V; V <sub>EE</sub> = -4.5 V	-	-	10	ns
t <sub>on</sub>	turn-on time	$\bar{E}$ to V <sub>os</sub> ; R <sub>L</sub> = ∞ Ω; see Fig. 14 [2]				
		V <sub>CC</sub> = 2.0 V; V <sub>EE</sub> = 0 V	-	-	275	ns
		V <sub>CC</sub> = 4.5 V; V <sub>EE</sub> = 0 V	-	-	55	ns
		V <sub>CC</sub> = 6.0 V; V <sub>EE</sub> = 0 V	-	-	47	ns
		V <sub>CC</sub> = 4.5 V; V <sub>EE</sub> = -4.5 V	-	-	39	ns
		Sn to V <sub>os</sub> ; R <sub>L</sub> = ∞ Ω; see Fig. 14 [2]				
		V <sub>CC</sub> = 2.0 V; V <sub>EE</sub> = 0 V	-	-	275	ns
		V <sub>CC</sub> = 4.5 V; V <sub>EE</sub> = 0 V	-	-	55	ns
		V <sub>CC</sub> = 6.0 V; V <sub>EE</sub> = 0 V	-	-	47	ns
		V <sub>CC</sub> = 4.5 V; V <sub>EE</sub> = -4.5 V	-	-	39	ns

Symbol	Parameter	Conditions	Min	Typ	Max	Unit
t <sub>off</sub>	turn-off time	$\bar{E}$ to V <sub>os</sub> ; R <sub>L</sub> = 1 kΩ; see Fig. 14 [3]				
		V <sub>CC</sub> = 2.0 V; V <sub>EE</sub> = 0 V	-	-	265	ns
		V <sub>CC</sub> = 4.5 V; V <sub>EE</sub> = 0 V	-	-	53	ns
		V <sub>CC</sub> = 6.0 V; V <sub>EE</sub> = 0 V	-	-	45	ns
		V <sub>CC</sub> = 4.5 V; V <sub>EE</sub> = -4.5 V	-	-	36	ns
		Sn to V <sub>os</sub> ; R <sub>L</sub> = 1 kΩ; see Fig. 14 [3]				
		V <sub>CC</sub> = 2.0 V; V <sub>EE</sub> = 0 V	-	-	265	ns
		V <sub>CC</sub> = 4.5 V; V <sub>EE</sub> = 0 V	-	-	53	ns
		V <sub>CC</sub> = 6.0 V; V <sub>EE</sub> = 0 V	-	-	45	ns
		V <sub>CC</sub> = 4.5 V; V <sub>EE</sub> = -4.5 V	-	-	36	ns
<b>T<sub>amb</sub> = -40 °C to +125 °C</b>						
t <sub>pd</sub>	propagation delay	V <sub>is</sub> to V <sub>os</sub> ; R <sub>L</sub> = ∞ Ω; see Fig. 13 [1]				
		V <sub>CC</sub> = 2.0 V; V <sub>EE</sub> = 0 V	-	-	90	ns
		V <sub>CC</sub> = 4.5 V; V <sub>EE</sub> = 0 V	-	-	18	ns
		V <sub>CC</sub> = 6.0 V; V <sub>EE</sub> = 0 V	-	-	15	ns
		V <sub>CC</sub> = 4.5 V; V <sub>EE</sub> = -4.5 V	-	-	12	ns
t <sub>on</sub>	turn-on time	$\bar{E}$ to V <sub>os</sub> ; R <sub>L</sub> = ∞ Ω; see Fig. 14 [2]				
		V <sub>CC</sub> = 2.0 V; V <sub>EE</sub> = 0 V	-	-	330	ns
		V <sub>CC</sub> = 4.5 V; V <sub>EE</sub> = 0 V	-	-	66	ns
		V <sub>CC</sub> = 6.0 V; V <sub>EE</sub> = 0 V	-	-	56	ns
		V <sub>CC</sub> = 4.5 V; V <sub>EE</sub> = -4.5 V	-	-	47	ns
		Sn to V <sub>os</sub> ; R <sub>L</sub> = ∞ Ω; see Fig. 14 [2]				
		V <sub>CC</sub> = 2.0 V; V <sub>EE</sub> = 0 V	-	-	330	ns
		V <sub>CC</sub> = 4.5 V; V <sub>EE</sub> = 0 V	-	-	66	ns
		V <sub>CC</sub> = 6.0 V; V <sub>EE</sub> = 0 V	-	-	56	ns
		V <sub>CC</sub> = 4.5 V; V <sub>EE</sub> = -4.5 V	-	-	47	ns
t <sub>off</sub>	turn-off time	$\bar{E}$ to V <sub>os</sub> ; R <sub>L</sub> = 1 kΩ; see Fig. 14 [3]				
		V <sub>CC</sub> = 2.0 V; V <sub>EE</sub> = 0 V	-	-	315	ns
		V <sub>CC</sub> = 4.5 V; V <sub>EE</sub> = 0 V	-	-	63	ns
		V <sub>CC</sub> = 6.0 V; V <sub>EE</sub> = 0 V	-	-	54	ns
		V <sub>CC</sub> = 4.5 V; V <sub>EE</sub> = -4.5 V	-	-	44	ns
		Sn to V <sub>os</sub> ; R <sub>L</sub> = 1 kΩ; see Fig. 14 [3]				
		V <sub>CC</sub> = 2.0 V; V <sub>EE</sub> = 0 V	-	-	315	ns
		V <sub>CC</sub> = 4.5 V; V <sub>EE</sub> = 0 V	-	-	63	ns
		V <sub>CC</sub> = 6.0 V; V <sub>EE</sub> = 0 V	-	-	54	ns
		V <sub>CC</sub> = 4.5 V; V <sub>EE</sub> = -4.5 V	-	-	44	ns

- [1] t<sub>pd</sub> is the same as t<sub>PHL</sub> and t<sub>PLH</sub>.
- [2] t<sub>on</sub> is the same as t<sub>PZH</sub> and t<sub>PZL</sub>.
- [3] t<sub>off</sub> is the same as t<sub>PHZ</sub> and t<sub>PLZ</sub>.
- [4] C<sub>PD</sub> is used to determine the dynamic power dissipation (P<sub>D</sub> in μW).  
 $P_D = C_{PD} \times V_{CC}^2 \times f_i \times N + \Sigma\{(C_L + C_{sw}) \times V_{CC}^2 \times f_o\}$  where:  
 f<sub>i</sub> = input frequency in MHz; f<sub>o</sub> = output frequency in MHz;  
 N = number of inputs switching;  $\Sigma\{(C_L + C_{sw}) \times V_{CC}^2 \times f_o\}$  = sum of outputs;  
 C<sub>L</sub> = output load capacitance in pF; C<sub>sw</sub> = switch capacitance in pF;  
 V<sub>CC</sub> = supply voltage in V.

**Table 10. Dynamic characteristics for 74HCT4053-Q100**

$GND = 0\text{ V}$ ;  $t_r = t_f = 6\text{ ns}$ ;  $C_L = 50\text{ pF}$ ; for test circuit see Fig. 15.

$V_{is}$  is the input voltage at a nYn or nZ terminal, whichever is assigned as an input.

$V_{os}$  is the output voltage at a nYn or nZ terminal, whichever is assigned as an output.

Symbol	Parameter	Conditions	Min	Typ	Max	Unit
<b><math>T_{amb} = 25\text{ °C}</math></b>						
$t_{pd}$	propagation delay	$V_{is}$ to $V_{os}$ ; $R_L = \infty\ \Omega$ ; see Fig. 13 [1]				
		$V_{CC} = 4.5\text{ V}$ ; $V_{EE} = 0\text{ V}$	-	5	12	ns
		$V_{CC} = 4.5\text{ V}$ ; $V_{EE} = -4.5\text{ V}$	-	4	8	ns
$t_{on}$	turn-on time	$\bar{E}$ to $V_{os}$ ; $R_L = 1\text{ k}\Omega$ ; see Fig. 14 [2]				
		$V_{CC} = 4.5\text{ V}$ ; $V_{EE} = 0\text{ V}$	-	27	48	ns
		$V_{CC} = 5.0\text{ V}$ ; $V_{EE} = 0\text{ V}$ ; $C_L = 15\text{ pF}$	-	23	-	ns
		$V_{CC} = 4.5\text{ V}$ ; $V_{EE} = -4.5\text{ V}$	-	16	34	ns
		Sn to $V_{os}$ ; $R_L = 1\text{ k}\Omega$ ; see Fig. 14 [2]				
		$V_{CC} = 4.5\text{ V}$ ; $V_{EE} = 0\text{ V}$	-	25	48	ns
		$V_{CC} = 5.0\text{ V}$ ; $V_{EE} = 0\text{ V}$ ; $C_L = 15\text{ pF}$	-	21	-	ns
		$V_{CC} = 4.5\text{ V}$ ; $V_{EE} = -4.5\text{ V}$	-	16	34	ns
$t_{off}$	turn-off time	$\bar{E}$ to $V_{os}$ ; $R_L = 1\text{ k}\Omega$ ; see Fig. 14 [3]				
		$V_{CC} = 4.5\text{ V}$ ; $V_{EE} = 0\text{ V}$	-	24	44	ns
		$V_{CC} = 5.0\text{ V}$ ; $V_{EE} = 0\text{ V}$ ; $C_L = 15\text{ pF}$	-	20	-	ns
		$V_{CC} = 4.5\text{ V}$ ; $V_{EE} = -4.5\text{ V}$	-	15	31	ns
		Sn to $V_{os}$ ; $R_L = 1\text{ k}\Omega$ ; see Fig. 14 [3]				
		$V_{CC} = 4.5\text{ V}$ ; $V_{EE} = 0\text{ V}$	-	22	44	ns
		$V_{CC} = 5.0\text{ V}$ ; $V_{EE} = 0\text{ V}$ ; $C_L = 15\text{ pF}$	-	19	-	ns
		$V_{CC} = 4.5\text{ V}$ ; $V_{EE} = -4.5\text{ V}$	-	15	31	ns
$C_{PD}$	power dissipation capacitance	per switch; $V_I = GND$ to $V_{CC} - 1.5\text{ V}$ [4]	-	36	-	pF
<b><math>T_{amb} = -40\text{ °C to }+85\text{ °C}</math></b>						
$t_{pd}$	propagation delay	$V_{is}$ to $V_{os}$ ; $R_L = \infty\ \Omega$ ; see Fig. 13 [1]				
		$V_{CC} = 4.5\text{ V}$ ; $V_{EE} = 0\text{ V}$	-	-	15	ns
		$V_{CC} = 4.5\text{ V}$ ; $V_{EE} = -4.5\text{ V}$	-	-	10	ns
$t_{on}$	turn-on time	$\bar{E}$ to $V_{os}$ ; $R_L = 1\text{ k}\Omega$ ; see Fig. 14 [2]				
		$V_{CC} = 4.5\text{ V}$ ; $V_{EE} = 0\text{ V}$	-	-	60	ns
		$V_{CC} = 4.5\text{ V}$ ; $V_{EE} = -4.5\text{ V}$	-	-	43	ns
		Sn to $V_{os}$ ; $R_L = 1\text{ k}\Omega$ ; see Fig. 14 [2]				
		$V_{CC} = 4.5\text{ V}$ ; $V_{EE} = 0\text{ V}$	-	-	60	ns
		$V_{CC} = 4.5\text{ V}$ ; $V_{EE} = -4.5\text{ V}$	-	-	43	ns
$t_{off}$	turn-off time	$\bar{E}$ to $V_{os}$ ; $R_L = 1\text{ k}\Omega$ ; see Fig. 14 [3]				
		$V_{CC} = 4.5\text{ V}$ ; $V_{EE} = 0\text{ V}$	-	-	55	ns
		$V_{CC} = 4.5\text{ V}$ ; $V_{EE} = -4.5\text{ V}$	-	-	39	ns
		Sn to $V_{os}$ ; $R_L = 1\text{ k}\Omega$ ; see Fig. 14 [3]				
		$V_{CC} = 4.5\text{ V}$ ; $V_{EE} = 0\text{ V}$	-	-	55	ns
		$V_{CC} = 4.5\text{ V}$ ; $V_{EE} = -4.5\text{ V}$	-	-	39	ns

Symbol	Parameter	Conditions	Min	Typ	Max	Unit
<b>T<sub>amb</sub> = -40 °C to +125 °C</b>						
t <sub>pd</sub>	propagation delay	V <sub>is</sub> to V <sub>os</sub> ; R <sub>L</sub> = ∞ Ω; see Fig. 13 [1]				
		V <sub>CC</sub> = 4.5 V; V <sub>EE</sub> = 0 V	-	-	18	ns
		V <sub>CC</sub> = 4.5 V; V <sub>EE</sub> = -4.5 V	-	-	12	ns
t <sub>on</sub>	turn-on time	$\bar{E}$ to V <sub>os</sub> ; R <sub>L</sub> = 1 kΩ; see Fig. 14 [2]				
		V <sub>CC</sub> = 4.5 V; V <sub>EE</sub> = 0 V	-	-	72	ns
		V <sub>CC</sub> = 4.5 V; V <sub>EE</sub> = -4.5 V	-	-	51	ns
		Sn to V <sub>os</sub> ; R <sub>L</sub> = 1 kΩ; see Fig. 14 [2]				
		V <sub>CC</sub> = 4.5 V; V <sub>EE</sub> = 0 V	-	-	72	ns
		V <sub>CC</sub> = 4.5 V; V <sub>EE</sub> = -4.5 V	-	-	51	ns
t <sub>off</sub>	turn-off time	$\bar{E}$ to V <sub>os</sub> ; R <sub>L</sub> = 1 kΩ; see Fig. 14 [3]				
		V <sub>CC</sub> = 4.5 V; V <sub>EE</sub> = 0 V	-	-	66	ns
		V <sub>CC</sub> = 4.5 V; V <sub>EE</sub> = -4.5 V	-	-	47	ns
		Sn to V <sub>os</sub> ; R <sub>L</sub> = 1 kΩ; see Fig. 14 [3]				
		V <sub>CC</sub> = 4.5 V; V <sub>EE</sub> = 0 V	-	-	66	ns
		V <sub>CC</sub> = 4.5 V; V <sub>EE</sub> = -4.5 V	-	-	47	ns

- [1] t<sub>pd</sub> is the same as t<sub>PHL</sub> and t<sub>PLH</sub>.
- [2] t<sub>on</sub> is the same as t<sub>PZH</sub> and t<sub>PZL</sub>.
- [3] t<sub>off</sub> is the same as t<sub>PHZ</sub> and t<sub>PLZ</sub>.
- [4] C<sub>PD</sub> is used to determine the dynamic power dissipation (P<sub>D</sub> in μW).  
 $P_D = C_{PD} \times V_{CC}^2 \times f_i \times N + \sum\{(C_L + C_{sw}) \times V_{CC}^2 \times f_o\}$  where:  
 f<sub>i</sub> = input frequency in MHz; f<sub>o</sub> = output frequency in MHz;  
 N = number of inputs switching;  $\sum\{(C_L + C_{sw}) \times V_{CC}^2 \times f_o\}$  = sum of outputs;  
 C<sub>L</sub> = output load capacitance in pF; C<sub>sw</sub> = switch capacitance in pF;  
 V<sub>CC</sub> = supply voltage in V.

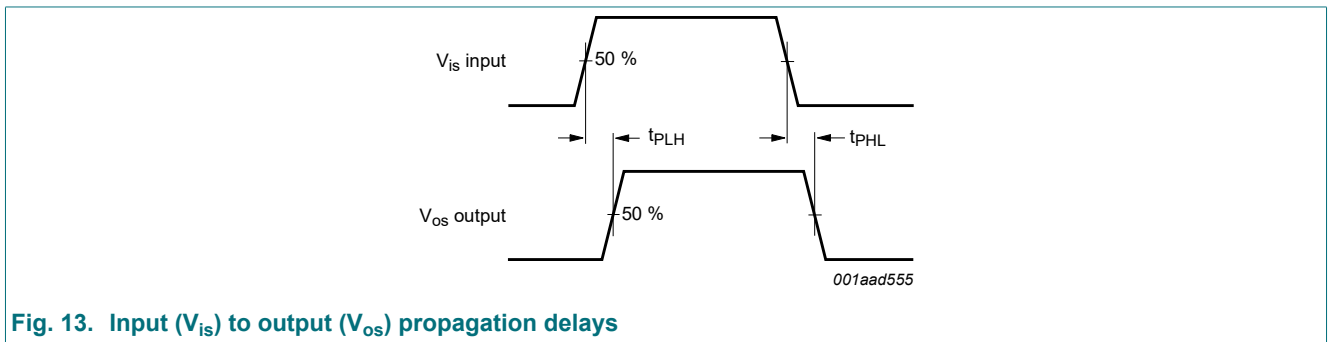

Fig. 13. Input (V<sub>is</sub>) to output (V<sub>os</sub>) propagation delays



For 74HC4053-Q100:  $V_M = 0.5 \times V_{CC}$ .  
 For 74HCT4053-Q100:  $V_M = 1.3 \text{ V}$ .

**Fig. 14. Turn-on and turn-off times**



Definitions for test circuit; see [Table 11](#):

$R_T$  = termination resistance should be equal to the output impedance  $Z_o$  of the pulse generator.

$C_L$  = load capacitance including jig and probe capacitance.

$R_L$  = load resistance.

S1 = Test selection switch.

**Fig. 15. Test circuit for measuring AC performance**



Table 11. Test data

Test	Input				Load		S1 position
	$V_I$ [1]	$V_{is}$	$t_r, t_f$		$C_L$	$R_L$	
			at $f_{max}$	other [2]			
$t_{PHL}, t_{PLH}$	$V_{CC}$	pulse	< 2 ns	6 ns	50 pF	1 k $\Omega$	open
$t_{PZH}, t_{PHZ}$	$V_{CC}$	$V_{CC}$	< 2 ns	6 ns	50 pF	1 k $\Omega$	$V_{EE}$
$t_{PZL}, t_{PLZ}$	$V_{CC}$	$V_{EE}$	< 2 ns	6 ns	50 pF	1 k $\Omega$	$V_{CC}$

[1] For 74HCT4053-Q100:  $V_I = 3$  V

[2]  $t_r = t_f = 6$  ns; when measuring  $f_{max}$ , there is no constraint to  $t_r$  and  $t_f$  with 50 % duty factor.

## 11.1. Additional dynamic characteristics

Table 12. Additional dynamic characteristics

Recommended conditions and typical values;  $GND = 0$  V;  $T_{amb} = 25$  °C;  $C_L = 50$  pF.

$V_{is}$  is the input voltage at pins nYn or nZ, whichever is assigned as an input.

$V_{os}$  is the output voltage at pins nYn or nZ, whichever is assigned as an output.

Symbol	Parameter	Conditions	Min	Typ	Max	Unit
$d_{sin}$	sine-wave distortion	$f_i = 1$ kHz; $R_L = 10$ k $\Omega$ ; see Fig. 16				
		$V_{is} = 4.0$ V (p-p); $V_{CC} = 2.25$ V; $V_{EE} = -2.25$ V	-	0.04	-	%
		$V_{is} = 8.0$ V (p-p); $V_{CC} = 4.5$ V; $V_{EE} = -4.5$ V	-	0.02	-	%
		$f_i = 10$ kHz; $R_L = 10$ k $\Omega$ ; see Fig. 16				
		$V_{is} = 4.0$ V (p-p); $V_{CC} = 2.25$ V; $V_{EE} = -2.25$ V	-	0.12	-	%
		$V_{is} = 8.0$ V (p-p); $V_{CC} = 4.5$ V; $V_{EE} = -4.5$ V	-	0.06	-	%
$\alpha_{iso}$	isolation (OFF-state)	$R_L = 600$ $\Omega$ ; $f_i = 1$ MHz; see Fig. 17				
		$V_{CC} = 2.25$ V; $V_{EE} = -2.25$ V [1]	-	-50	-	dB
		$V_{CC} = 4.5$ V; $V_{EE} = -4.5$ V [1]	-	-50	-	dB
Xtalk	crosstalk	between two switches/multiplexers; $R_L = 600$ $\Omega$ ; $f_i = 1$ MHz; see Fig. 18				
		$V_{CC} = 2.25$ V; $V_{EE} = -2.25$ V [1]	-	-60	-	dB
		$V_{CC} = 4.5$ V; $V_{EE} = -4.5$ V [1]	-	-60	-	dB
$V_{ct}$	crosstalk voltage	peak-to-peak value; between control and any switch; $R_L = 600$ $\Omega$ ; $f_i = 1$ MHz; $\bar{E}$ or Sn square wave between $V_{CC}$ and GND; $t_r = t_f = 6$ ns; see Fig. 19				
		$V_{CC} = 4.5$ V; $V_{EE} = 0$ V	-	110	-	mV
		$V_{CC} = 4.5$ V; $V_{EE} = -4.5$ V	-	220	-	mV
$f_{(-3dB)}$	-3 dB frequency response	$R_L = 50$ $\Omega$ ; see Fig. 20				
		$V_{CC} = 2.25$ V; $V_{EE} = -2.25$ V [2]	-	160	-	MHz
		$V_{CC} = 4.5$ V; $V_{EE} = -4.5$ V [2]	-	170	-	MHz

[1] Adjust input voltage  $V_{is}$  to 0 dBm level (0 dBm = 1 mW into 600  $\Omega$ ).

[2] Adjust input voltage  $V_{is}$  to 0 dBm level at  $V_{os}$  for 1 MHz (0 dBm = 1 mW into 50  $\Omega$ ).



Fig. 16. Test circuit for measuring sine-wave distortion



$V_{CC} = 4.5\text{ V}$ ;  $GND = 0\text{ V}$ ;  $V_{EE} = -4.5\text{ V}$ ;  $R_L = 600\ \Omega$ ;  $R_S = 1\text{ k}\Omega$ .  
a. Test circuit



b. Isolation (OFF-state) as a function of frequency

Fig. 17. Test circuit for measuring isolation (OFF-state)



Fig. 18. Test circuits for measuring crosstalk between any two switches/multiplexers



Fig. 19. Test circuit for measuring crosstalk between control input and any switch

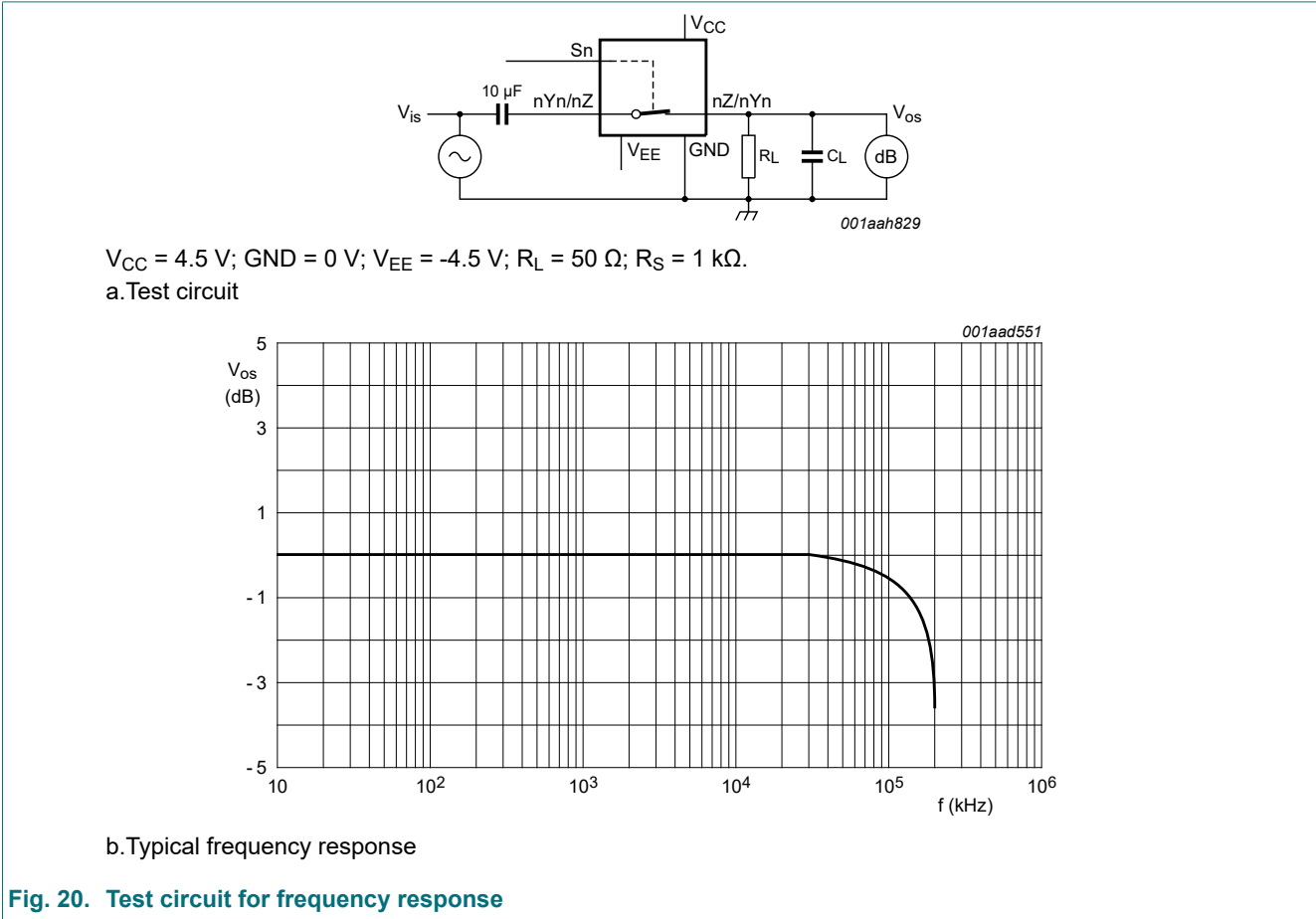

Fig. 20. Test circuit for frequency response

## 12. Package outline

SO16: plastic small outline package; 16 leads; body width 3.9 mm

SOT109-1



Fig. 21. Package outline SOT109-1 (SO16)

TSSOP16: plastic thin shrink small outline package; 16 leads; body width 4.4 mm

SOT403-1



Fig. 22. Package outline SOT403-1 (TSSOP16)

DHVQFN16: plastic dual in-line compatible thermal enhanced very thin quad flat package; no leads; 16 terminals; body 2.5 x 3.5 x 0.85 mm

SOT763-1



Fig. 23. Package outline SOT763-1 (DHVQFN16)

## 13. Abbreviations

Table 13. Abbreviations

Acronym	Description
CDM	Charged Device Model
ESD	ElectroStatic Discharge
HBM	Human Body Model
MIL	Military
MM	Machine Model

## 14. Revision history

Table 14. Revision history

Document ID	Release date	Data sheet status	Change notice	Supersedes
74HC_HCT4053_Q100 v.3	20200305	Product data sheet	-	74HC_HCT4053_Q100 v.2
Modifications:	<ul style="list-style-type: none"> <li>The format of this data sheet has been redesigned to comply with the identity guidelines of Nexperia.</li> <li>Legal texts have been adapted to the new company name where appropriate.</li> <li><a href="#">Section 1</a> updated.</li> <li><a href="#">Section 2</a> updated.</li> <li><a href="#">Table 4</a>: Derating values for <math>P_{tot}</math> total power dissipation updated.</li> </ul>			
74HC_HCT4053_Q100 v.2	20121122	Product data sheet	-	74HC_HCT4053_Q100 v.1
Modifications:	<ul style="list-style-type: none"> <li>CDM added to features.</li> </ul>			
74HC_HCT4053_Q100 v.1	20120720	Product data sheet	-	-

## 15. Legal information

### Data sheet status

Document status [1][2]	Product status [3]	Definition
Objective [short] data sheet	Development	This document contains data from the objective specification for product development.
Preliminary [short] data sheet	Qualification	This document contains data from the preliminary specification.
Product [short] data sheet	Production	This document contains the product specification.

- [1] Please consult the most recently issued document before initiating or completing a design.
- [2] The term 'short data sheet' is explained in section "Definitions".
- [3] The product status of device(s) described in this document may have changed since this document was published and may differ in case of multiple devices. The latest product status information is available on the internet at <https://www.nexperia.com>.

### Definitions

**Draft** — The document is a draft version only. The content is still under internal review and subject to formal approval, which may result in modifications or additions. Nexperia does not give any representations or warranties as to the accuracy or completeness of information included herein and shall have no liability for the consequences of use of such information.

**Short data sheet** — A short data sheet is an extract from a full data sheet with the same product type number(s) and title. A short data sheet is intended for quick reference only and should not be relied upon to contain detailed and full information. For detailed and full information see the relevant full data sheet, which is available on request via the local Nexperia sales office. In case of any inconsistency or conflict with the short data sheet, the full data sheet shall prevail.

**Product specification** — The information and data provided in a Product data sheet shall define the specification of the product as agreed between Nexperia and its customer, unless Nexperia and customer have explicitly agreed otherwise in writing. In no event however, shall an agreement be valid in which the Nexperia product is deemed to offer functions and qualities beyond those described in the Product data sheet.

### Disclaimers

**Limited warranty and liability** — Information in this document is believed to be accurate and reliable. However, Nexperia does not give any representations or warranties, expressed or implied, as to the accuracy or completeness of such information and shall have no liability for the consequences of use of such information. Nexperia takes no responsibility for the content in this document if provided by an information source outside of Nexperia.

In no event shall Nexperia be liable for any indirect, incidental, punitive, special or consequential damages (including - without limitation - lost profits, lost savings, business interruption, costs related to the removal or replacement of any products or rework charges) whether or not such damages are based on tort (including negligence), warranty, breach of contract or any other legal theory.

Notwithstanding any damages that customer might incur for any reason whatsoever, Nexperia's aggregate and cumulative liability towards customer for the products described herein shall be limited in accordance with the Terms and conditions of commercial sale of Nexperia.

**Right to make changes** — Nexperia reserves the right to make changes to information published in this document, including without limitation specifications and product descriptions, at any time and without notice. This document supersedes and replaces all information supplied prior to the publication hereof.

**Suitability for use in automotive applications** — This Nexperia product has been qualified for use in automotive applications. Unless otherwise agreed in writing, the product is not designed, authorized or warranted to be suitable for use in life support, life-critical or safety-critical systems or

equipment, nor in applications where failure or malfunction of an Nexperia product can reasonably be expected to result in personal injury, death or severe property or environmental damage. Nexperia and its suppliers accept no liability for inclusion and/or use of Nexperia products in such equipment or applications and therefore such inclusion and/or use is at the customer's own risk.

**Quick reference data** — The Quick reference data is an extract of the product data given in the Limiting values and Characteristics sections of this document, and as such is not complete, exhaustive or legally binding.

**Applications** — Applications that are described herein for any of these products are for illustrative purposes only. Nexperia makes no representation or warranty that such applications will be suitable for the specified use without further testing or modification.

Customers are responsible for the design and operation of their applications and products using Nexperia products, and Nexperia accepts no liability for any assistance with applications or customer product design. It is customer's sole responsibility to determine whether the Nexperia product is suitable and fit for the customer's applications and products planned, as well as for the planned application and use of customer's third party customer(s). Customers should provide appropriate design and operating safeguards to minimize the risks associated with their applications and products.

Nexperia does not accept any liability related to any default, damage, costs or problem which is based on any weakness or default in the customer's applications or products, or the application or use by customer's third party customer(s). Customer is responsible for doing all necessary testing for the customer's applications and products using Nexperia products in order to avoid a default of the applications and the products or of the application or use by customer's third party customer(s). Nexperia does not accept any liability in this respect.

**Limiting values** — Stress above one or more limiting values (as defined in the Absolute Maximum Ratings System of IEC 60134) will cause permanent damage to the device. Limiting values are stress ratings only and (proper) operation of the device at these or any other conditions above those given in the Recommended operating conditions section (if present) or the Characteristics sections of this document is not warranted. Constant or repeated exposure to limiting values will permanently and irreversibly affect the quality and reliability of the device.

**Terms and conditions of commercial sale** — Nexperia products are sold subject to the general terms and conditions of commercial sale, as published at <http://www.nexperia.com/profile/terms>, unless otherwise agreed in a valid written individual agreement. In case an individual agreement is concluded only the terms and conditions of the respective agreement shall apply. Nexperia hereby expressly objects to applying the customer's general terms and conditions with regard to the purchase of Nexperia products by customer.

**No offer to sell or license** — Nothing in this document may be interpreted or construed as an offer to sell products that is open for acceptance or the grant, conveyance or implication of any license under any copyrights, patents or other industrial or intellectual property rights.

**Export control** — This document as well as the item(s) described herein may be subject to export control regulations. Export might require a prior authorization from competent authorities.

**Translations** — A non-English (translated) version of a document is for reference only. The English version shall prevail in case of any discrepancy between the translated and English versions.

### Trademarks

Notice: All referenced brands, product names, service names and trademarks are the property of their respective owners.



## Contents

---

<b>1. General description</b> .....	<b>1</b>
<b>2. Features and benefits</b> .....	<b>1</b>
<b>3. Applications</b> .....	<b>1</b>
<b>4. Ordering information</b> .....	<b>2</b>
<b>5. Functional diagram</b> .....	<b>2</b>
<b>6. Pinning information</b> .....	<b>4</b>
6.1. Pinning.....	4
6.2. Pin description.....	4
<b>7. Functional description</b> .....	<b>4</b>
<b>8. Limiting values</b> .....	<b>5</b>
<b>9. Recommended operating conditions</b> .....	<b>5</b>
<b>10. Static characteristics</b> .....	<b>6</b>
<b>11. Dynamic characteristics</b> .....	<b>11</b>
11.1. Additional dynamic characteristics.....	17
<b>12. Package outline</b> .....	<b>20</b>
<b>13. Abbreviations</b> .....	<b>23</b>
<b>14. Revision history</b> .....	<b>23</b>
<b>15. Legal information</b> .....	<b>24</b>

---

© Nexperia B.V. 2020. All rights reserved

For more information, please visit: <http://www.nexperia.com>

For sales office addresses, please send an email to: [salesaddresses@nexperia.com](mailto:salesaddresses@nexperia.com)

Date of release: 5 March 2020

---