

Cyclone LC Programmers

User Manual



Purchase Agreement

P&E Microcomputer Systems, Inc. reserves the right to make changes without further notice to any products herein to improve reliability, function, or design. P&E Microcomputer Systems, Inc. does not assume any liability arising out of the application or use of any product or circuit described herein.

This software and accompanying documentation are protected by United States Copyright law and also by International Treaty provisions. Any use of this software in violation of copyright law or the terms of this agreement will be prosecuted.

All the software described in this document is copyrighted by P&E Microcomputer Systems, Inc. Copyright notices have been included in the software.

P&E Microcomputer Systems authorizes you to make archival copies of the software and documentation for the sole purpose of back-up and protecting your investment from loss. Under no circumstances may you copy this software or documentation for the purpose of distribution to others. Under no conditions may you remove the copyright notices from this software or documentation.

This software may be used by one person on as many computers as that person uses, provided that the software is never used on two computers at the same time. P&E expects that group programming projects making use of this software will purchase a copy of the software and documentation for each user in the group. Contact P&E for volume discounts and site licensing agreements.

P&E Microcomputer Systems does not assume any liability for the use of this software beyond the original purchase price of the software. In no event will P&E Microcomputer Systems be liable for additional damages, including any lost profits, lost savings or other incidental or consequential damages arising out of the use or inability to use these programs, even if P&E Microcomputer Systems has been advised of the possibility of such damage.

By using this software, you accept the terms of this agreement.

©2015-2019 P&E Microcomputer Systems, Inc.

ARM and Cortex are registered trademarks of ARM Ltd. or its subsidiaries.

NXP, ColdFire, and Kinetis are registered trademarks of NXP Semiconductors.

Texas Instruments and TI are registered trademarks of Texas Instruments Incorporated.

STMicroelectronics is a registered trademark of STMicroelectronics, Inc.

All other product or service names are the property of their respective owners.

P&E Microcomputer Systems, Inc.
98 Galen St.
Watertown, MA 02472
617-923-0053
<http://www.pemicro.com>

Manual version: 1.17

July 2019

1	INTRODUCTION.....	9
1.1	Cyclone Feature Comparison.....	9
1.2	Advanced Feature Licenses.....	9
1.2.1	ProCryption Security License	9
1.2.2	Cyclone Control Suite Advanced Features License	10
1.2.3	SDHC Port Activation License.....	10
2	QUICK START GUIDE FOR SAP OPERATION	11
2.1	Installing The Cyclone Software.....	11
2.2	Setting Up The Cyclone Hardware.....	11
2.3	Creating A Stand-Alone Programming Image.....	13
2.3.1	Advanced Features	16
2.4	Launching Cyclone Programming	16
3	CYCLONE LC HARDWARE	18
3.1	Touchscreen LCD	18
3.2	LED Indicators.....	18
3.3	Start Button	18
3.4	Access Panel.....	18
3.5	Cyclone System Power	19
3.6	RS232 Communication (Serial Port).....	19
3.7	Ethernet Communication	19
3.8	USB Communications	19
3.9	Electromechanical Relays.....	19
3.10	Power Connectors.....	20
3.11	Reset Button.....	20
3.12	SDHC Port.....	20
3.13	Optional Oscillator (MON08 Only).....	21
3.14	Cyclone Time / Real Time Clock.....	21
3.15	Power Jumper Settings	21
3.16	Debug Connectors	21
3.17	Target Headers For Part# CYCLONE-LC-ARM	23
3.17.1	PORT A: 10-Pin Keyed Mini Connector (Kinetis, S32 (ARM), other PEmicro-Supported ARM devices)	23
3.17.2	PORT B: 20-Pin Keyed Mini Connector (Kinetis, S32 (ARM), other PEmicro-Supported ARM devices)	24
3.17.3	PORT C: 20-Pin Debug Connector (Kinetis, S32 (ARM), other PEmicro-Supported ARM devices)	25
3.18	Target Headers For Part# CYCLONE-LC-UNIV	26
3.18.1	PORT A: 10-Pin Keyed Mini Connector (Kinetis, S32 (ARM), other PEmicro-Supported ARM devices)	26
3.18.2	PORT B: 20-Pin Keyed Mini Connector (Kinetis, S32 (ARM), other PEmicro-Supported ARM devices)	27
3.18.3	PORT C: 14-Pin Debug Connector (MPC55xx-57xx, SPC5, DSC, S32 (Power))	28
3.18.4	PORT D: 26-Pin Debug Connector (ColdFire V2/3/4).....	29
3.18.5	PORT E: 16-Pin Debug Connector (MON08).....	30
3.18.6	PORT F: 6-Pin Debug Connector (RS08, HCS08, HC(S)12(X), S12Z, ColdFire +/V1, STM8 w/ adapter).....	31
3.18.7	PORT G: 10-Pin Debug Connector (Power MPC5xx/8xx)	32

3.18.8	PORT H: 20-Pin Debug Connector (Kinetis, S32 (ARM), other PEmicro-Supported ARM devices)	32
3.19	Ribbon Cable	33
4	TARGET POWER MANAGEMENT	34
4.1	Cyclone Configuration	34
4.2	Cyclone Setup	36
4.2.1	Independently Powered Target	36
4.2.2	Power provided by the Cyclone to the debug cable	36
4.2.3	External Power passed through the Cyclone and out 2.5 mm barrel port	37
4.2.4	External Power passed through the Cyclone to the debug cable	37
4.2.5	Power provided by the Cyclone and out 2.5 mm barrel port	38
4.3	Setup Reminders	38
5	TOUCHSCREEN LCD MENU	39
5.1	Home Screen	39
5.1.1	Icons	39
5.1.2	Configurable Display Area	39
5.1.3	Status Window	40
5.1.4	Error Information Icon	40
5.1.5	AUX Button (Appears If Configured)	40
5.2	Main Menu	40
5.2.1	Select Programming Image	42
5.2.2	Current Image Options	42
5.2.3	Configure Cyclone Settings	44
5.2.4	Status	47
6	CREATING AND MANAGING PROGRAMMING IMAGES	48
6.1	Cyclone Image Creation Utility	48
6.1.1	Specify CPU Manufacturer	49
6.1.2	Security Settings - Qorivva (MPC55xx-57xx) Only	51
6.1.3	Programming Sequence	51
6.1.4	Programming Operations	54
6.1.5	Communication Mode and Rate Settings	56
6.1.6	Target Voltage and Power Settings	56
6.1.7	Image Description	56
6.1.8	ProCryption Security License Features	56
6.1.9	FX Exclusive Features	59
6.1.10	Store Image To Cyclone	59
6.1.11	Store Image To Disk	60
6.1.12	Save Cyclone Configuration	60
6.1.13	Load Cyclone Configuration	60
6.2	Managing Multiple SAP Images	60
6.2.1	Delete Images From Internal/External Memory	61
6.2.2	Add/Remove Images From The Commit Changes Panels	61
7	CYCLONE PROGRAMMER MANUAL CONTROL	63

7.1	Operation Via Start Button	63
7.1.1	LED Indicators	63
7.1.2	Procedure via Start Button / LEDs	63
7.1.3	Example	63
7.2	Operation Via LCD Touchscreen Menu	64
7.3	Home Screen	64
7.3.1	Icons.....	64
7.3.2	Configurable Display Area.....	64
7.4	Status Window	65
7.4.1	Error Information Icon.....	65
7.4.2	AUX Button (Appears If Configured)	65
7.4.3	Main Menu.....	65
8	CYCLONE PROGRAMMER AUTOMATED CONTROL (CYCLONE CONTROL SUITE)	68
8.1	Overview Of Cyclone Control Suite.....	68
8.1.1	Components	68
8.1.2	Features	68
8.1.3	PEmicro Compatible Hardware	69
8.2	Cyclone Control SDK	69
8.2.1	Introduction.....	69
8.2.2	Backwards Compatibility With Classic Cyclone Control API	70
8.2.3	Getting Started with the Cyclone Control DLL.....	70
8.2.4	Application Programming Interface (API)	73
8.3	Cyclone Control Console.....	87
8.3.1	Startup.....	87
8.3.2	Command-Line Parameters	87
8.3.3	Examples.....	89
8.4	Cyclone Control GUI	90
8.4.1	The Connection Dialog.....	91
8.4.2	The Control Tabs.....	92
8.4.3	The Status and Error Window:	97
8.5	License	97
8.5.1	Hardware Licensing.....	97
9	SAP IMAGE COMPILER (SCRIPTED PROGRAMMING & IMAGE CREATION).....	98
9.1	Launching From the Command Line	98
9.1.1	Command-Line Example	98
9.1.2	Filename and Additional Command-Line Parameters.....	99
9.1.3	List of Valid Command-Line Parameters.....	99
9.2	Configuration (.CFG) File Contents.....	100
9.2.1	Sample .CFG File.....	100
9.2.2	Configuration Commands.....	101
9.2.3	Programming Commands	106
9.2.4	Using Command Line Parameters Inside a .CFG File	107

9.2.5	Sample Batch File	108
9.3	CSAP Error Returns	108
10	ETHERNET CONFIGURATION	111
10.1	Network Architectures	111
10.2	Network Parameters.....	111
10.3	Internet Protocol.....	112
10.4	Connecting The Cyclone Device.....	112
10.4.1	Connecting the Cyclone to the PC over a network.....	112
10.4.2	Connecting Cyclone-to-PC via an Ethernet cable	113
10.5	Cyclone IP Setup Via LCD Menu	113
10.5.1	Configure Network Settings.....	113
10.6	Configuring Cyclone Network Settings using the Cyclone Control GUI	114
11	SAP IMAGE ENCRYPTION	116
11.1	Overview	116
11.2	Encrypting/Decrypting a Programming Image.....	116
11.3	What is Encrypted in an eSAP File, and How	116
11.4	Managing Encryption For Production Programming	117
11.4.1	Provisioning a Cyclone with an ImageKey	117
11.4.2	Removing ImageKeys From A Cyclone	119
11.4.3	Loading and Programming with Encrypted SAP Images	119
11.4.4	Encryption Status of SAP Images	120
11.5	Safer Production That's Easy To Implement.....	121
12	AUTOMATIC SERIAL NUMBER MECHANISM	122
12.1	Understanding Serialization	122
12.2	Serialize Utility.....	122
12.2.1	Startup And File Options	123
12.2.2	Serial Number File.....	124
12.2.3	Serial File Unique ID	124
12.2.4	Serial File Name To Display.....	124
12.2.5	Serial File Notes.....	124
12.2.6	Number of Bytes in Serial Number.....	124
12.2.7	Starting HEX Address	124
12.2.8	Count Sequence.....	124
12.2.9	Serial Number Bytes as Hex	124
12.2.10	Hex Upper Bounds.....	125
12.2.11	Hex Lower Bounds.....	125
12.2.12	Binary, Numeric, Constant, Alpha Upper, Alpha Lower, and Printable	125
12.2.13	Byte Program Order	125
12.3	Serial File Properties	125
12.3.1	Serial File Example	125
12.4	Serial Number Handling	126
12.4.1	Invoking A Serial File Via Command-Line.....	127

12.5	Creating A SAP Image With Multiple Serial Numbers.....	127
12.6	Shared Serial Numbers	128
12.6.1	Example	128
13	CYCLONE LICENSE INSTALLATION	133
13.1	How to Install Your License	133
14	TROUBLESHOOTING	138
14.1	My Cyclone Is Non-Responsive, Is There A Way To Re-Activate It?.....	138
14.1.1	What Is Bootloader Mode?.....	138
14.1.2	When Is Bootloader Mode Used?	138
14.1.3	How Is Bootloader Mode Entered?	138
14.2	I Received A “SAP Image Needs To Be Updated” Error Using A Next-Gen Cyclone, How Do I Update? .	138
14.2.1	How Do I Use SAP_Convert_Console.exe?	138
14.3	When Trying To Install The CYCLONE Software, A Popup WDREG Error Occurs Telling Me That There Are Open Devices Using WinDriver.....	139
15	ERROR CODES.....	140
15.1	Debug Mode Communication Related Errors.....	140
15.2	SAP Image Handling Related Errors.....	140
15.3	SAP Communication Handling Related Errors.....	141
15.4	SAP Algorithm Header Operation Handling Related Errors	141
15.5	SAP Operation Related Errors	141
15.6	SAP Blank Check Range and Module Related Errors	141
15.7	SAP Erase Range and Module Related Errors	141
15.8	SAP Program Byte, Word, and Module Related Errors.....	141
15.9	SAP Verify Checksum Related Errors.....	142
15.10	SAP Verify Range and Module Related Errors	142
15.11	SAP User Function Related Errors.....	142
15.12	SAP Trim Related Errors	142
15.13	Unrecoverable Fatal Errors	142
15.14	Operation Security Related Errors	143
15.15	External Memory-Related Errors.....	143
15.16	Serial Number Related Errors	144
15.17	Download Count Related Errors.....	144
15.18	System Hardware/Firmware/Logic Recoverable Errors	144
16	CYCLONE FEATURE OVERVIEW / COMPARISON	145
17	TECHNICAL INFORMATION.....	149
17.1	Life Expectancy	149
17.2	Electrical Specifications.....	149
17.3	Mechanical Specifications	149
17.4	Electromechanical Relays	149
17.5	Debug Ports - CYCLONE-LC-ARM.....	149

17.6	Debug Ports - CYCLONE-LC-UNIV	149
17.7	International Shipping.....	149
17.8	Compliances/Standards	149

1 INTRODUCTION

PEmicro's **Cyclone LC** production programmers are powerful, fast, and feature rich in-circuit programming solutions. PEmicro offers two models which have the same feature set and only vary by the devices supported.

Part# CYCLONE-LC-ARM supports a wide variety of ARM Cortex devices.

Part# CYCLONE-LC-UNIV supports those ARM Cortex devices as well as the following NXP device families: Kinetis, LPC, S32, MPC55xx-57xx), MPC5xx/8xx, DSC, S12Z, RS08, S08, HC08, HC(S)12(X), ColdFire, and STMicroelectronics' SPC5 & STM8.

Note: PEmicro refreshed Cyclone names and part numbers in July 2019. The part numbers listed on earlier Cyclones will differ slightly. CYCLONE is now called Cyclone LC, however the hardware has not changed.

CYCLONE LC PROGRAMMERS: SUPPORTED ARCHITECTURES

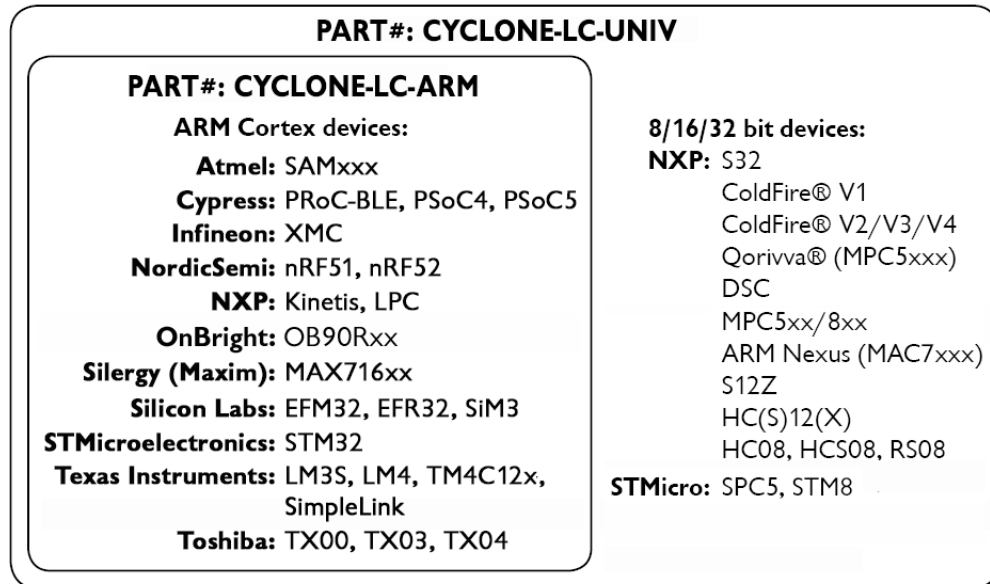

Figure 1-1: Cyclone LC Supported Architectures

Cyclone LC programmers are designed to withstand the demands of a production environment. They are Stand-Alone Programmers (SAP) that can be operated manually or used to host automated programming. In manual SAP mode the Cyclone is operated using the touchscreen LCD Menu and/or the Start button. Host-controlled SAP mode, for automated programming, is accomplished using the Cyclone Control Suite.

1.1 Cyclone Feature Comparison

In addition to **Cyclone LC** programmers, PEmicro offers **Cyclone FX** programmers that include enhanced speed, storage, and security features, plus advanced Cyclone control/automation features which make them an incredibly powerful and versatile solution. See **CHAPTER 16 - CYCLONE FEATURE OVERVIEW / COMPARISON** for a **CYCLONE** feature overview and comparison with the **Cyclone FX** programmers.

1.2 Advanced Feature Licenses

PEmicro offers **Cyclone LC** users the flexibility to add many of the advanced security, automation/control, and expandable memory features included with the **Cyclone FX**. These features can be added by purchasing and installing the appropriate activation license.

1.2.1 ProCryption Security License

The ProCryption Security License offers two extremely valuable security features:

1. RSA/AES encryption of programming images

Users create unique ImageKeys which are used to encrypt their programming images. SAP images encrypted in this way can only be loaded onto a Cyclone or programmed with a Cyclone if that Cyclone has been provisioned with the identical ImageKey.

2. The ability to restrict image programming by programming count or date range.

Programming restrictions on images are easily configured during the image creation process.

Together these security features help keep the user's valuable IP safe. The user should refer to **CHAPTER 11 - SAP IMAGE ENCRYPTION** for more information on encrypted programming images. Image restrictions are described in **Section 6.1.8.2 - Image Restrictions**.

1.2.2 Cyclone Control Suite Advanced Features License

Cyclone LC programmers include a basic version of the Cyclone Control Suite. The Advanced Cyclone Control Suite Update license enables additional features that allow the user to:

- Add/Remove/Update many images in the Cyclone (Console, SDK, GUI)
- Gang program: Simultaneously control multiple Cyclones via the USB, Serial, or Ethernet connections
- Program (and read) Dynamic Data in addition to fixed image data
- Access a Remote Display for the Cyclone
- Read/write Cyclone properties
- Read Image and target Properties and Status
- Compare images against a SAP file

This gives the user much more control and flexibility during the production process. The user should refer to **Section 8.1 - Overview Of Cyclone Control Suite** for more information.

1.2.3 SDHC Port Activation License

The SDHC Port Activation License activates the SDHC port of the **Cyclone LC**. This allows the user expand the storage capacity of the Cyclone by loading images onto SDHC cards. SDHC cards can hold more and larger images than a **Cyclone LC** programmer can normally accommodate. The Cyclone display and management tools allow the user to easily distinguish between "internal" and "external" images. **Section 6.2 - Managing Multiple SAP Images** displays an example of how external images are differentiated.

2 QUICK START GUIDE FOR SAP OPERATION

This guide will allow the user to set up and program a simple Stand-Alone Programming (SAP) image with the Cyclone by completing the following steps.

- Installing the Cyclone software
- Setting up the Cyclone hardware
- Creating a stand-alone programming image
- Launching Cyclone programming

This guide is intended as a supplement to the Cyclone's User Manual, which contains in-depth information about the topics covered here and much more.

2.1 Installing The Cyclone Software

First, the Cyclone software should be installed on the user's PC. It can be downloaded from the Support & Downloads tab on the pemicro.com Cyclone product page, or directly from https://www.pemicro.com/downloads/download_file.cfm?download_id=481.

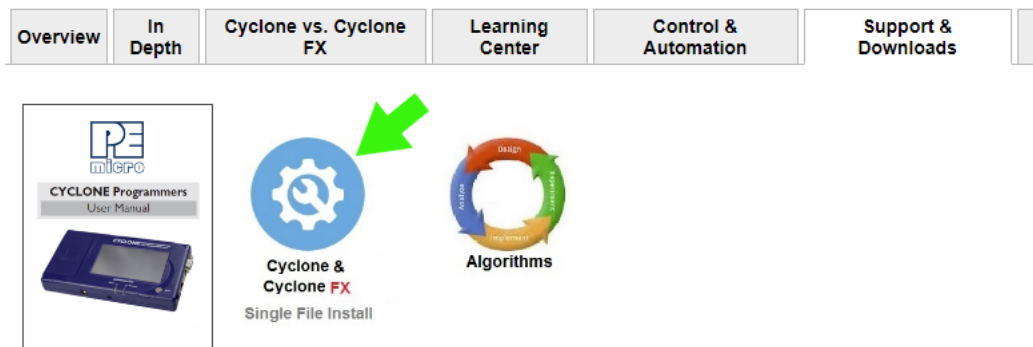

Once the software is downloaded, the user should install it on their PC. If Cyclone software is already installed on the PC, it is recommended that the old installation be removed before the user installs the latest software.

2.2 Setting Up The Cyclone Hardware

Step 1. Configure Cyclone power settings

The Cyclone has several different power configurations. The label on the bottom of the Cyclone indicates the appropriate Jumper settings for each. The user should install the Jumpers as indicated for their desired power configuration.

The Jumpers are located underneath the Cyclone's access panel. They are labeled "Power Jumpers." and numbered from 1-4. The Cyclone-LC-ARM is shown in the example below; the jumper location will be similar for all Cyclone models.

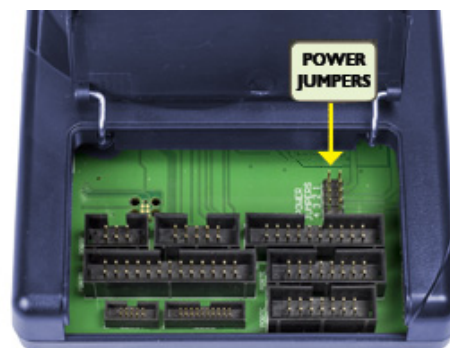
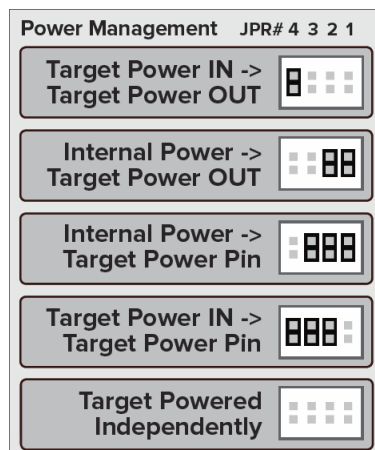

If power is provided via the Cyclone, the user may need to configure the programming image accordingly. Image creation and configuration is discussed in **Section 2.3 - Creating A Stand-Alone Programming Image**.

For more information on the various power configurations, the user should refer to their Cyclone's User Manual. There is also a blog post that covers this topic at: http://www.pemicro.com/blog/index.cfm?post_id=121

Step 2. Connect Cyclone to a PC (for programming image setup)

The Cyclone programmer should be connected to the PC via USB, Serial, or Ethernet. Cables for each of these options are included with the Cyclone.

Note: An Ethernet connection requires IP setup on the Cyclone unit; please refer to the Cyclone's User Manual for more information.

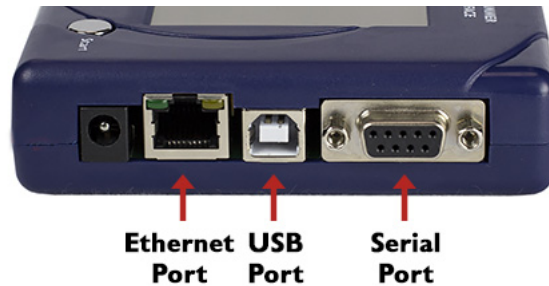

Step 3. Connect Cyclone to target

A ribbon cable should be connected from the appropriate Cyclone header (located under the Cyclone's access panel) to the header for your target device. Ribbon cables are provided with the Cyclone.

Cyclone Universal & Cyclone FX Universal (FX Model Shown)

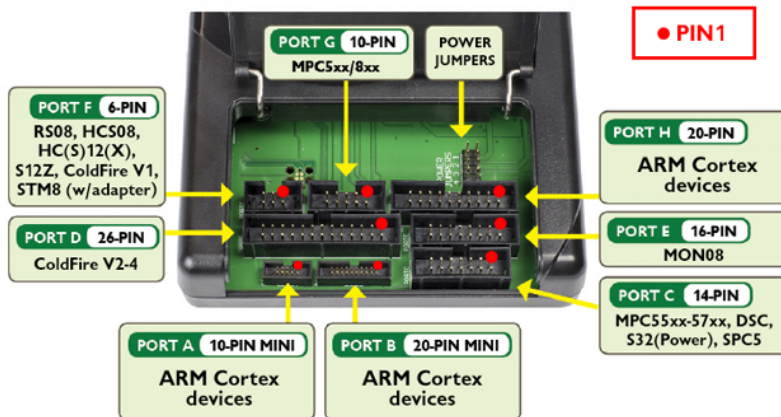

Cyclone ARM & Cyclone FX ARM (FX Model Shown)

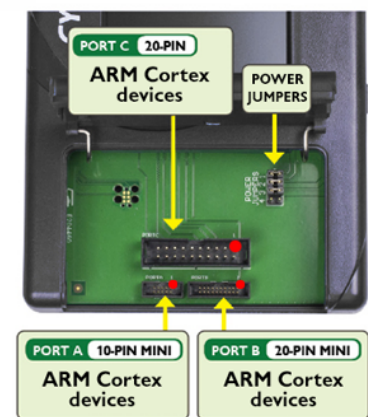

Step 4. Plug in power to the Cyclone

The provided power supply should be plugged into the System Power jack of the Cyclone programmer. Other power connections should be made according to the power configuration selected in Step 1.



On power-up the user may need to agree to a firmware update on the Cyclone unit.

Creating A Stand-Alone Programming Image

A stand-alone programming (SAP) image is the result of pre-processing the programming algorithms, data to be programmed, programming options, and scripted programming commands. These are combined into a single encrypted file. This SAP image can then be loaded onto the Cyclone and used to program, without need for the Cyclone to be connected to a PC.

The Cyclone Image Creation Utility, shown below, allows the user to configure and save SAP images. A simple programming image can be created in 6 steps:

Step 1. Run Cyclone Image Creation Utility

Step 2. Select Device Manufacturer & Device

Step 3. Set Up Programming Sequence

Step 4. Add Basic Programming Commands

Step 5. Configure Additional Settings

Step 6. Save SAP Image To Cyclone

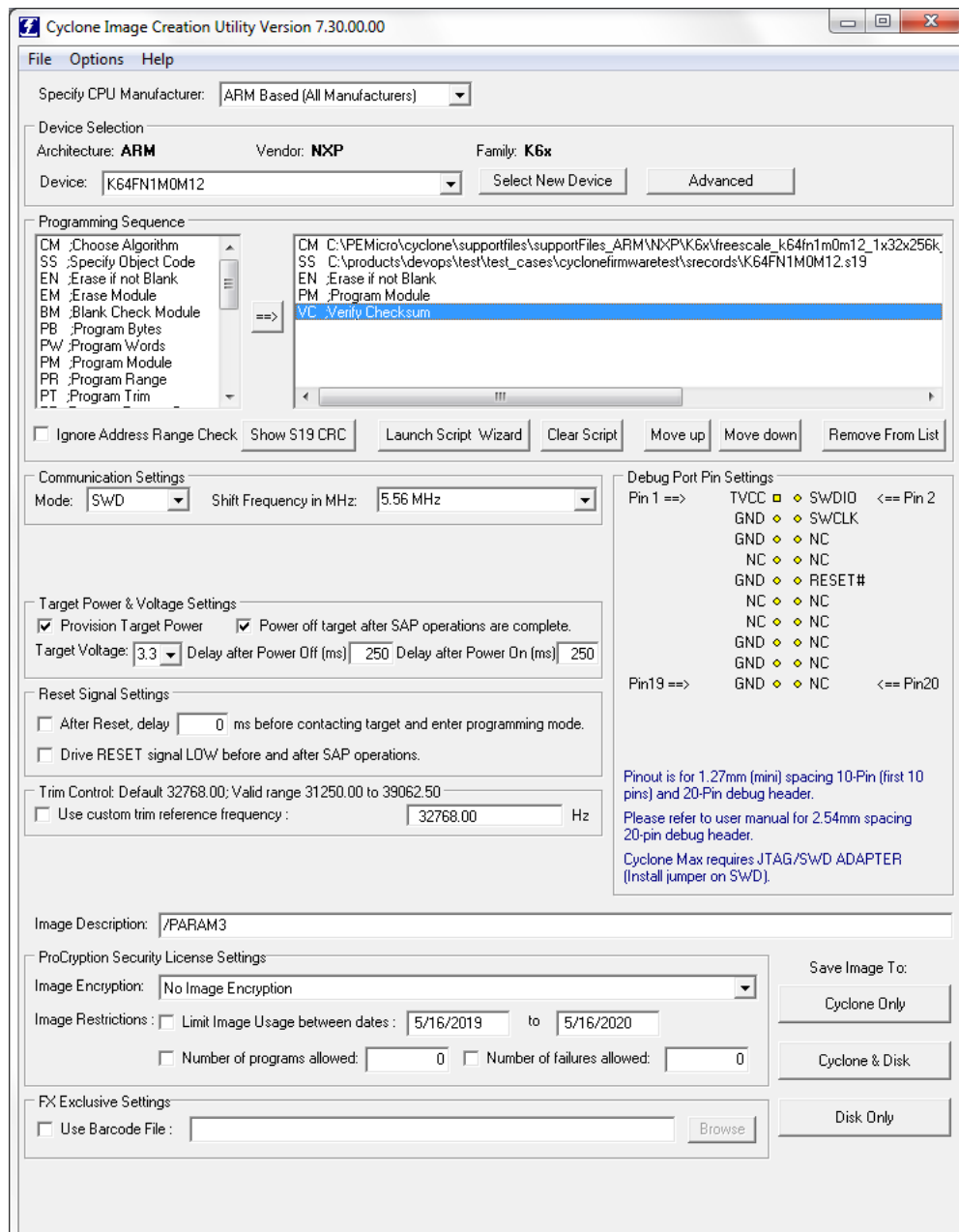

The following instructions walk the user through each of these steps:

Step 1. Run Cyclone Image Creation Utility

CreateImage.exe is in the “ImageCreation” folder, in the location where the Cyclone software was installed. For an in-depth description of the Cyclone Image Creation Utility, see **Section 6.1 - Cyclone Image Creation Utility**.

Step 2. Select Device Manufacturer and Device

Specify CPU Manufacturer and Select New Device are used to choose the manufacturer of the target device, and then the specific device or architecture.

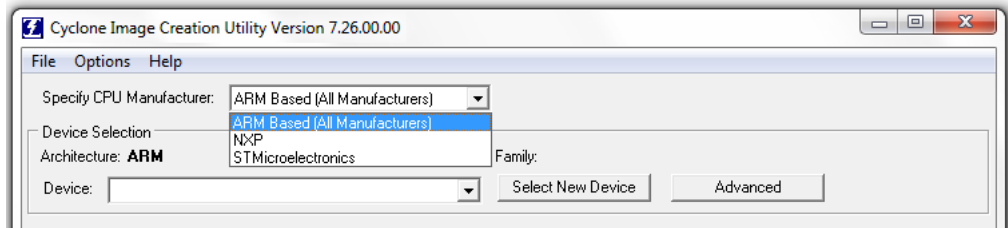

Step 3. Programming Sequence Setup

The user should double-click on CM in the Programming Sequence window to choose the appropriate Algorithm for the target device. They can navigate to the algorithm using the dialog provided.

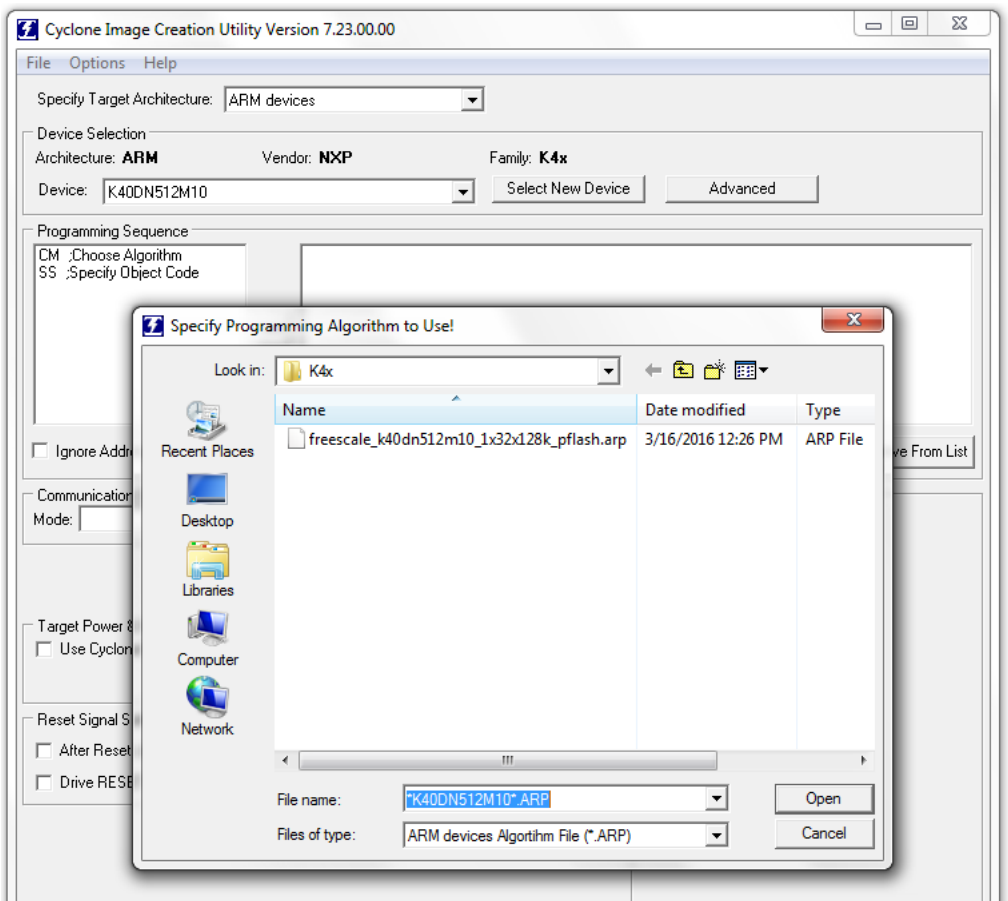

Based on the algorithm that was selected, additional commands will be made available in the box of programming commands on the left.

The user should then double-click on the SS command to specify the Object Code.

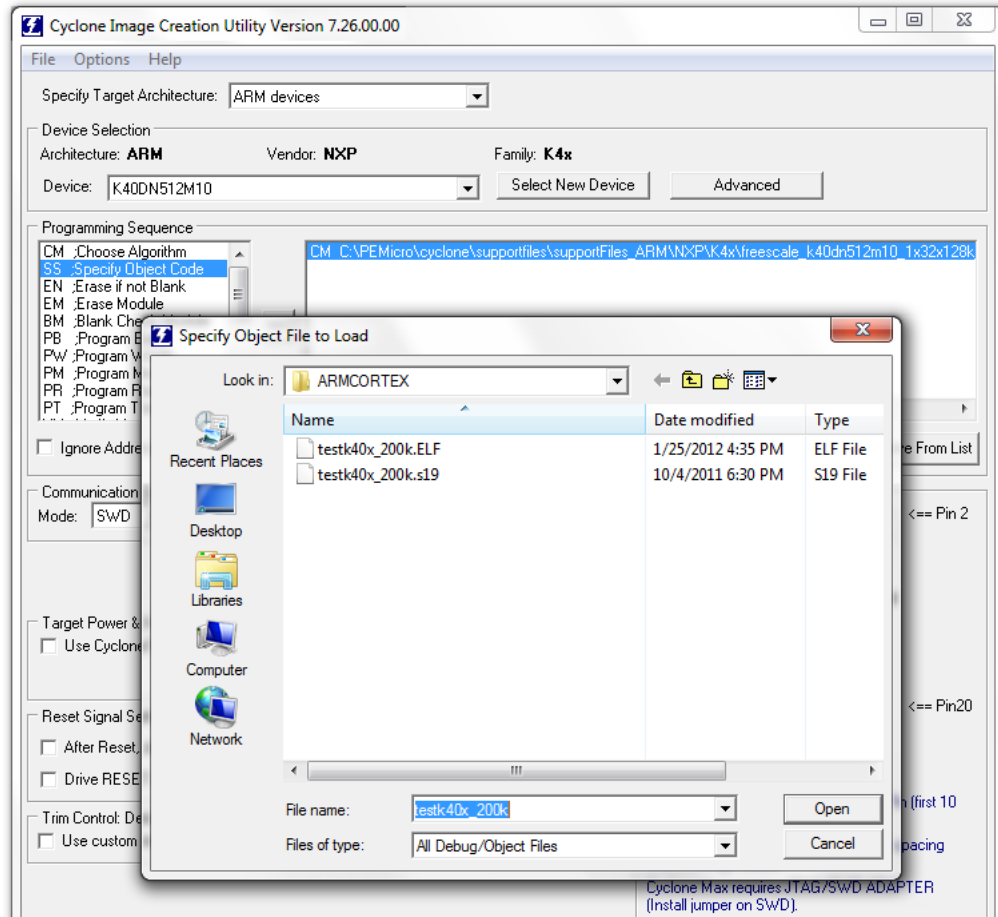

Step 4. Adding Basic Programming Commands

The user should then add other basic programming commands, using the list of commands on the left side of the Programming Sequence area. The arrow and buttons allow the user to add, remove, and re-sequence the commands, in the box on the right. As an example, some basic commands might be

- Erase
- Program
- Verify

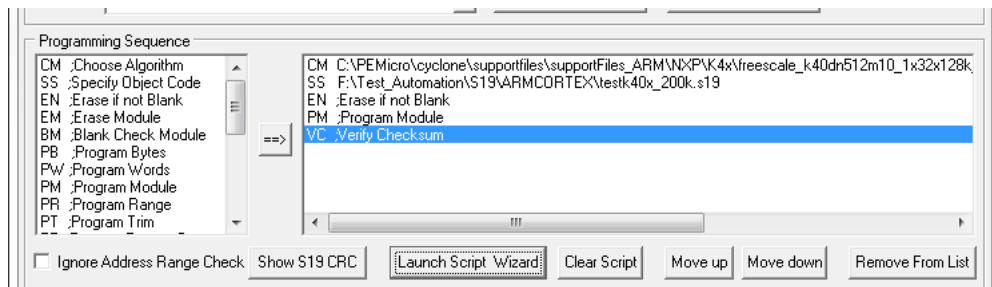

Note: Launch Script Wizard can also be used to quickly complete Steps 3 and 4.

Step 5. Other Settings

The user should then specify any other settings that the SAP image should contain in order to program correctly, such as

- Communication SWD vs JTAG
- Shift frequency
- Target Power and Voltage Settings

These settings can be made using the corresponding areas of the Cyclone Image Creation Utility.

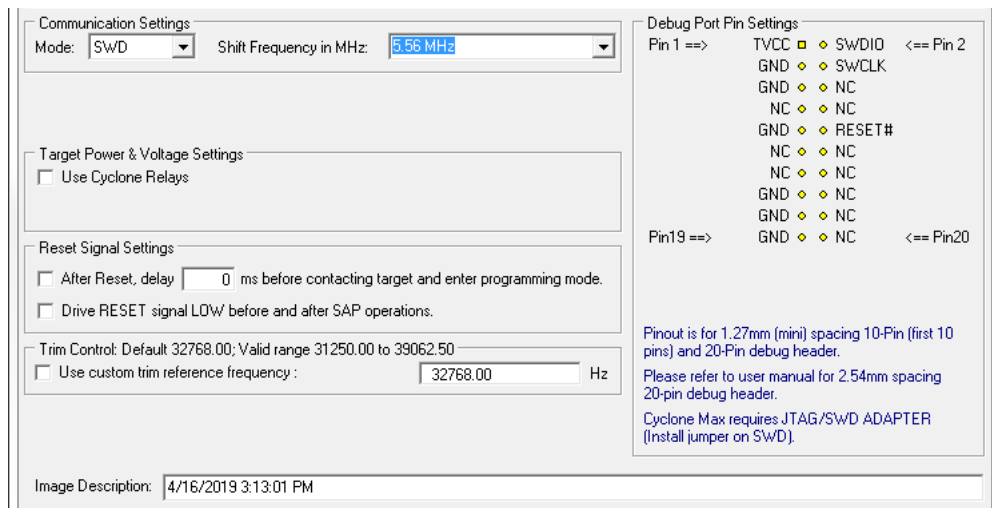

Step 6. Save SAP image to Cyclone

The user should then save the SAP image onto the Cyclone by clicking the button to save to “Cyclone Only” or “Cyclone & Disk.” The image will be automatically selected as the current SAP image on the Cyclone.



2.3.1 Advanced Features

Cyclone programmers can take advantage of several advanced features that are beyond the scope of this Getting Started guide, such as RSA/AES encrypted programming images, programming restrictions on images (see **Section 6.1.8 - ProCryption Security License Features**), and use of a barcode scanner to launch programming (see **CHAPTER 12 - USING A BARCODE SCANNER TO SELECT AN IMAGE & INITIATE PROGRAMMING**). CYCLONE FX programmers include all of these features, and CYCLONE programmers can use many of these features with the appropriate activation license.

2.4 Launching Cyclone Programming

There are three ways to launch programming.

1. Cyclone Start Button Press - The user simply presses the Start button located on top of the Cyclone programmer.



2. Cyclone Control Console (command-line utility) - The user writes a script that specifies parameters and initiates programming using the command line. More information is avail-

able in the Cyclone's User manual or at: http://www.pemicro.com/blog/index.cfm?post_id=142

3. SDK - The SDK is a software library that is used in conjunction with the user's own code. The user writes a customer application that uses this library of functions to launch programming. More information is available in the Cyclone's User Manual, or at: http://www.pemicro.com/blog/index.cfm?post_id=139

The "Success" or "Error" LED will illuminate to let the user know the result of programming.

Note: If programming is unsuccessful when using this quick start procedure, the user may instead wish to use the included PROG software for their target device. The PROG software allows the user to manually walk through the programming procedure step by step, which may help determine which part of setup or programming function is causing difficulty.

3 CYCLONE LC HARDWARE

The following is an overview of the features and interfaces of **Cyclone LC** programmers. Many of these interfaces are labeled on the underside of the plastic case.



Figure 3-1: Cyclone LC Top View

3.1 Touchscreen LCD

The LCD Touchscreen displays information about the Cyclone’s configuration and the programming process, and also allows the user to navigate the Cyclone’s menus. The location of the Touchscreen LCD is shown in **Figure 3-1**.

3.2 LED Indicators

The LED indicators for Error or Success will illuminate depending on the results of the programming process and provide a clear visual indication of the results. The location of the LED Indicators is shown in **Figure 3-1**.

3.3 Start Button

The Start Button can be used to begin the programming process manually, provided that the Cyclone is properly configured. The location of the Start Button is shown in **Figure 3-1**.

3.4 Access Panel

The Access Panel can easily be opened to allow the user to connect/disconnect ribbon cables from the headers, or to configure the Cyclone’s Power Jumpers to select one of the available Power Management setups. The location of the Access Panel is shown in **Figure 3-1**; a layout of the headers and jumpers beneath the Access Panel is shown in **Figure 3-5**.



Figure 3-2: Cyclone LC Right Side View

3.5 Cyclone System Power

The **Cyclone LC** programmer requires a regulated 6V DC Center Positive power supply with 2.5/5.5mm female plug. Cyclones derive power from the Power Jack located on the right end of the unit. The location of Cyclone System Power is shown in **Figure 3-2**.

3.6 RS232 Communication (Serial Port)

The **Cyclone LC** provides a DB9 Female connector to communicate with a host computer through the RS232 communication (115200 Baud, 8 Data bits, No parity, 1 Stop bit). The location of the Serial Port is shown in **Figure 3-2**.

3.7 Ethernet Communication

The **Cyclone LC** provides a standard RJ45 socket to communicate with a host computer through the Ethernet Port (10/100 BaseT). The location of the Ethernet Port is shown in **Figure 3-2**.

3.8 USB Communications

The **Cyclone LC** provides a USB connector for Universal Serial Bus communications between the Cyclone and the host computer. The **Cyclone LC** is a USB 2.0 **Full-Speed** compliant device. The location of the USB Port is shown in **Figure 3-2**.

3.9 Electromechanical Relays

Inside the **Cyclone LC** programmer, two electromechanical relays are used to cycle target power. The specifications of the relays are as following:

Maximum switched power:	30W or 125 VA
Maximum switched current:	1A
Maximum switched voltage:	150VDC or 300VAC
UL Rating:	1A at 30 VDC 1A at 125 VAC

PEmicro only recommends switching DC voltages up to 24 Volts.

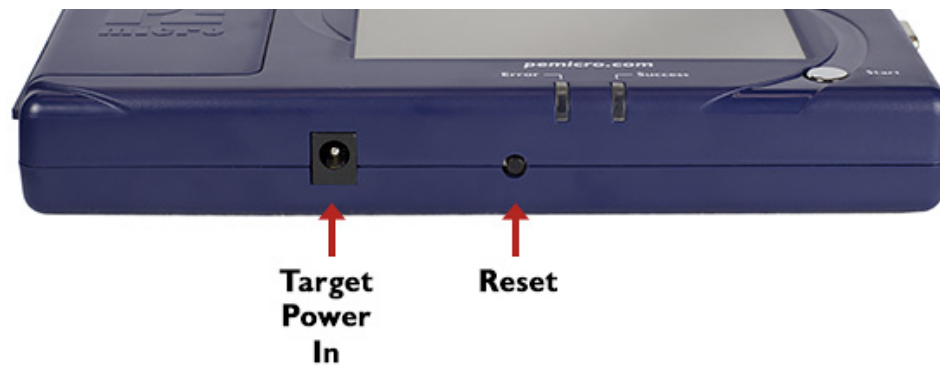

Figure 3-3: Cyclone LC Front Side View

3.10 Power Connectors

The **Cyclone LC** programmers provide a Target Power Supply Input Jack and a Target Power Supply Output Jack with 2.5/5.5 mm Pin Diameter. The power jacks are connected or disconnected by two electromechanical relays. When connected, the Center Pin of the Target Power Supply Input Jack is connected to the Center Pin of the Target Power Supply Output Jack. When disconnected, both terminals of the Target Power Supply Output Jack are connected to GND via a 1W, 100 Ohm resistor. The location of Target Power In is shown in **Figure 3-3**, and the location of Target Power Out is shown in **Figure 3-3**.

3.11 Reset Button

The Reset Button performs a hard reset of the Cyclone system. The location of the Reset Button is shown in **Figure 3-3**.



Figure 3-4: Cyclone LC Rear Side View

3.12 SDHC Port

Note: The SDHC port is activated on all **Cyclone FX** programmers, and may be activated on **Cyclone LC** programmers via purchase of the SDHC Port Activation License.

The SDHC port allows the user to store programming images that are, individually or collectively, larger than the Cyclone’s internal memory. It also makes it quicker and more convenient to swap programming images. PE micro offers certified SDHC cards on our website at pemicro.com. The location of the SDHC Port is shown in **Figure 3-4**.

Programming images are managed on the SD card in exactly the same way as they are in the Cyclone’s internal memory. Please see **Section 6.2 - Managing Multiple SAP Images** for more information about using the Manage Images utility.

Note: To view detailed information about the status of the SDHC card/port, tap the icon bar at the top of the touchscreen menu. This status can provide you with relevant information if you are

encountering any difficulty while trying to use an SDHC card.

3.13 Optional Oscillator (MON08 Only)

Cyclone LC programmers with MON08 support (PEmicro Part# CYCLONE-LC-UNIV only) provide a software configurable 9.8304MHz or 4.9152 MHz oscillator clock signal to Pin 13 of the MON08 Connector. The user may use this clock signal to overdrive the target RC or crystal circuitry. If this signal is not used, just leave Pin 13 of the target MON08 header unconnected.

Please note that if the target already uses an oscillator as its clock, the Cyclone will NOT be able to overdrive it. The clock should have sufficient drive to be used with a target system even if the target system has an RC circuit or crystal connected.

3.14 Cyclone Time / Real Time Clock

Cyclone LC programmers are equipped with a Real Time Clock (RTC) module designed to keep accurate timing even when the Cyclone is turned off.

The Date & Time are displayed on the home screen. Date/Time settings can be configured by navigating to the following menu using the touchscreen display:

Main Menu / Configure Cyclone Settings / Configure Time Settings

For more information on the available configuration options, see **Section 5.2.3.3 - Configure Time Settings (Cyclone Time / Real Time Clock)**.

3.15 Power Jumper Settings

The Power Jumpers must be set differently for various power management options that the **Cyclone LC** offers. If the target is being powered independently of the **Cyclone LC**, all pins in the Power Jumpers header must instead be left unpopulated. To reveal the Power Jumpers header, lift the access panel on the left end of the **Cyclone LC**. The location is indicated as Power Jumpers in **Figure 3-5**. Please see **CHAPTER 4 - TARGET POWER MANAGEMENT** for the correct jumper settings for the Cyclone's power management options. A quick guide to these settings is also located on the underside label of the **Cyclone LC**.

3.16 Debug Connectors

When purchasing a **Cyclone LC** programmer, the user is able to choose between two part numbers, each corresponding to a different level of device support. See the sticker on the underside of the Cyclone to determine the PEmicro part# for your specific **Cyclone LC** programmer.

PEmicro Part# CYCLONE-LC-ARM supports ARM Cortex devices only, so this programmer provides one shrouded, un-keyed, 0.100-inch pitch dual row 0.025-inch square header, and two shrouded, keyed 0.050-inch pitch dual row mini headers.

PEmicro Part# CYCLONE-LC-UNIV supports ARM Cortex devices and additionally supports target connections to many 8-/16-/32-bit NXP architectures, so this programmer provides six shrouded, un-keyed, 0.100-inch pitch dual row 0.025-inch square headers, and two shrouded, keyed 0.050-inch pitch dual row mini headers.

To reveal the headers and connect/disconnect ribbon cables, lift the access panel on the left end of the Cyclone. Each header is designated for one or more specific target architectures, as indicated in **Figure 3-5**.

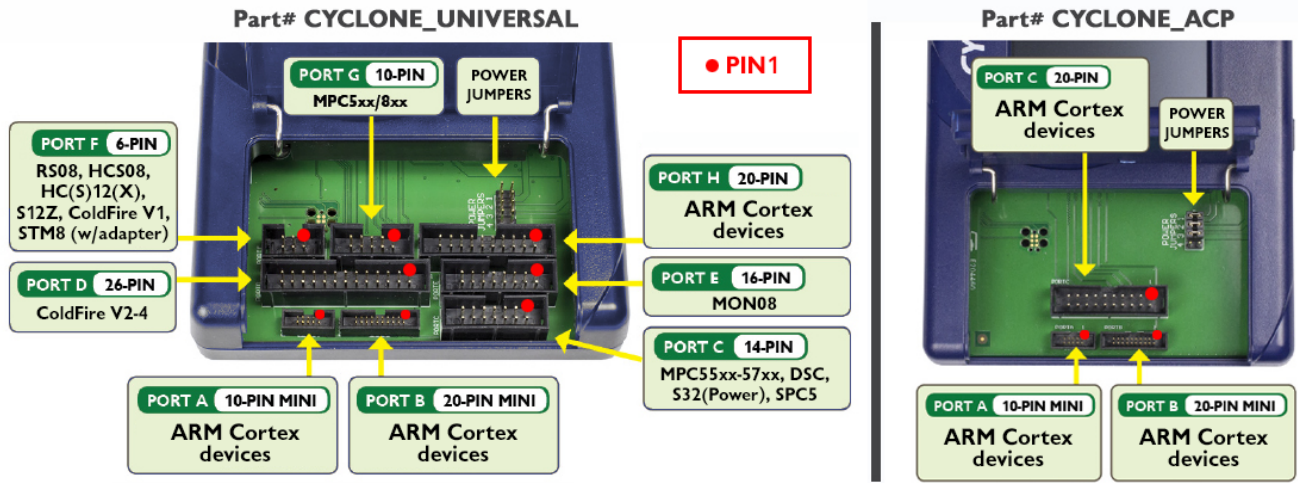

Figure 3-5: Target Headers & Power Jumpers (CYCLONE-LC-UNIV vs.CYCLONE-LC-ARM)

Mechanical drawings are shown below whose dimensions are representative of the pin size and spacing of these headers.

Note: The number of pins depicted in the mechanical drawings may differ from the Cyclone headers; the drawings are provided simply to demonstrate pin size and spacing.

0.100" Dual Row, 0.025" Square Header

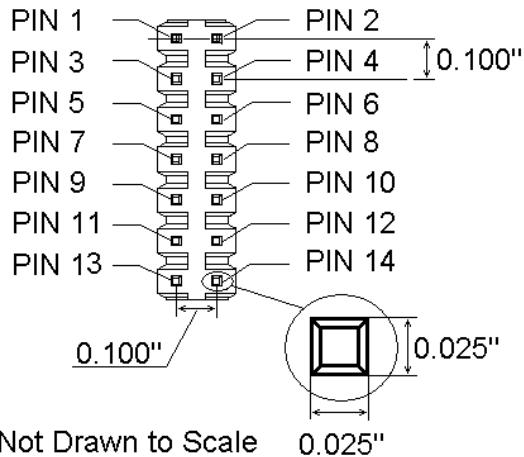

Figure 3-6: 20-Pin Un-Keyed Header Dimensions

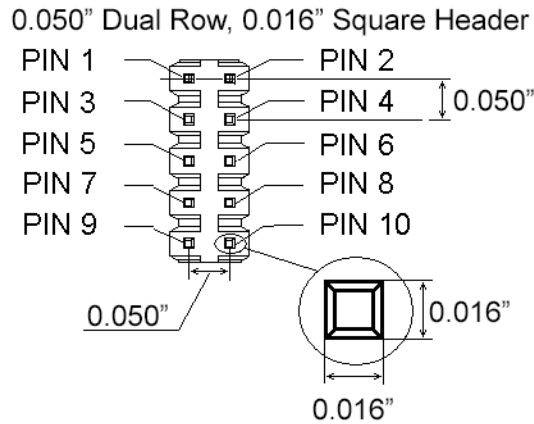

Figure 3-7: Mini 10-Pin and Mini 20-Pin Keyed Header Dimensions

3.17 Target Headers For Part# CYCLONE-LC-ARM

PEmicro Part# CYCLONE-LC-ARM features 3 ports labeled A-C.

3.17.1 PORT A: 10-Pin Keyed Mini Connector (Kinetis, S32 (ARM), other PEmicro-Supported ARM devices)

3.17.1.1 JTAG Pin Assignments

The Cyclone provides a keyed 10-pin 0.050-inch pitch double row connector for ARM targets. The location of the this header is indicated as PORT A in **Figure 3-5**. The 10-pin keyed mini connector pin definitions for JTAG mode are as follows:

10-Pin Keyed Mini Connector JTAG Mode Pin Assignments

PIN 1 - TVCC	TMS - PIN 2
PIN 3 - GND	TCK - PIN 4
PIN 5 - GND	TDO - PIN 6
PIN 7 - NC	TDI - PIN 8
PIN 9 - NC*	RESET - PIN 10

Note: *The pin is reserved for internal use within the PEmicro interface.

Cyclone LC programmers also support SWD Mode. This replaces the JTAG connection with a clock and single bi-directional data pin.

3.17.1.2 SWD Mode Pin Assignments

10-Pin Keyed Mini Connector SWD Mode Pin Assignments

PIN 1 - TVCC	TMS/SWDIO - PIN 2
PIN 3 - GND	TCK/SWCLK - PIN 4
PIN 5 - GND	NC* - PIN 6
PIN 7 - NC	NC* - PIN 8
PIN 9 - NC*	RESET - PIN 10

Note: *The pin is reserved for internal use within the PEmicro interface.

SWD Mode is selected from the “Communication Mode” drop-down box in the Cyclone Image Creation Utility:

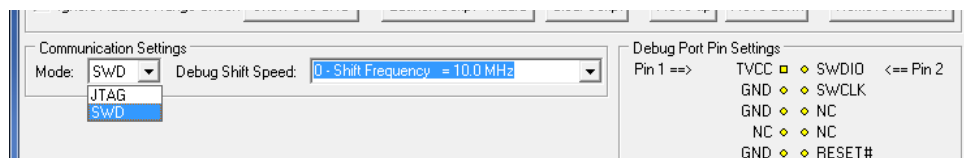

Figure 3-8: Communications Mode Selection

3.17.1.2.1 High-Performance Communications (FX ONLY)

If high-performance options are available for the selected device they will appear in the “Shift Frequency in MHz” drop-down. **Cyclone FX** programmers are capable of high-performance communications when using certain ARM Cortex targets in SWD mode.

Note: **Cyclone LC** programmers cannot currently take advantage of high-performance options, although the frequencies appear in the display.

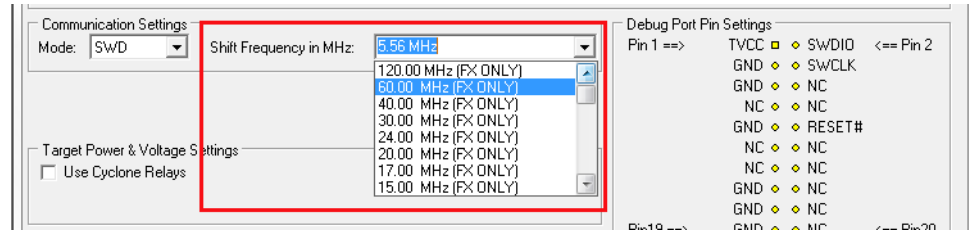

Figure 3-9: High-Performance Options (FX ONLY)

3.17.2 PORT B: 20-Pin Keyed Mini Connector (Kinetis, S32 (ARM), other PEmicro-Supported ARM devices)

3.17.2.1 JTAG Mode Pin Assignments

The Cyclone provides a keyed 20-pin 0.050-inch pitch double row connector for ARM targets. The location of the this header is indicated as PORT B in **Figure 3-5**. The 20-pin keyed mini connector pin definitions for JTAG mode are as follows:

20-Pin Keyed Mini Connector JTAG Mode Pin Assignments

PIN 1 - TVCC	TMS - PIN 2
PIN 3 - GND	TCK - PIN 4
PIN 5 - GND	TDO - PIN 6
PIN 7 - NC	TDI - PIN 8
PIN 9 - NC*	RESET - PIN 10
PIN 11 - NC	NC* - PIN 12
PIN 13 - NC	NC* - PIN 14
PIN 15 - GND	NC* - PIN 16
PIN 17 - GND	NC* - PIN 18
PIN 19 - GND	NC* - PIN 20

Note: *The pin is reserved for internal use within the PEmicro interface.

3.17.2.2 SWD Mode Pin Assignments

Cyclone LC programmers also support SWD Mode. This replaces the JTAG connection with a clock and single bi-directional data pin.

20-Pin Keyed Mini Connector SWD Mode Pin Assignments

PIN 1 - TVCC	TMS/SWDIO - PIN 2
PIN 3 - GND	TCK/SWCLK - PIN 4
PIN 5 - GND	NC* - PIN 6
PIN 7 - NC	NC* - PIN 8
PIN 9 - NC*	RESET - PIN 10
PIN 11 - NC	NC* - PIN 12
PIN 13 - NC	NC* - PIN 14
PIN 15 - GND	NC* - PIN 16
PIN 17 - GND	NC* - PIN 18
PIN 19 - GND	NC* - PIN 20

Note: *The pin is reserved for internal use within the PEmicro interface.

SWD Mode is selected from the “Communication Mode” drop-down box in the Cyclone Image Creation Utility:

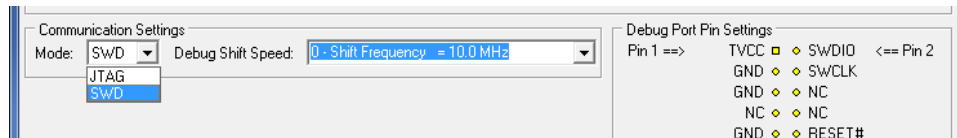

Figure 3-10: Communications Mode Selection

3.17.2.2.1 High-Performance Communications (FX ONLY)

If high-performance options are available for the selected device they will appear in the “Shift Frequency in M Hz” drop-down. **Cyclone FX** programmers are capable of high-performance communications when using certain ARM Cortex targets in SWD mode.

Note: **Cyclone LC** programmers cannot currently take advantage of high-performance options, although the frequencies appear in the display.

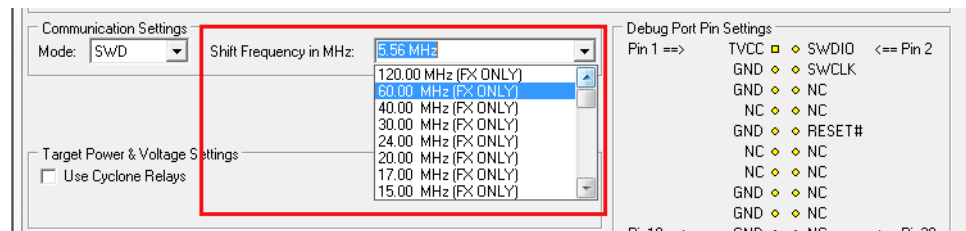

Figure 3-11: High-Performance Options (FX ONLY)

3.17.3 PORT C: 20-Pin Debug Connector (Kinetis, S32 (ARM), other PEmicro-Supported ARM devices)

3.17.3.1 JTAG Mode Pin Assignments

The Cyclone provides a 20-pin 0.100-inch pitch double row connector for ARM targets. The location of this header is indicated as **PORT C** under Part# CYCLONE-LC-ARM in **Figure 3-5**. The 20-pin standard connector pin definitions for JTAG mode are as follows:

20-Pin Standard Connector JTAG Mode Pin Assignments

PIN 1 - TVCC	NC* - PIN 2
PIN 3 - TRST or NC	GND - PIN 4
PIN 5 - TDI	GND - PIN 6
PIN 7 - TMS	GND - PIN 8
PIN 9 - TCK	GND - PIN 10
PIN 11 - NC*	GND - PIN 12
PIN 13 - TDO	GND - PIN 14
PIN 15 - RESET	GND - PIN 16
PIN 17 - NC*	GND - PIN 18
PIN 19 - NC*	GND - PIN 20

Note: *The pin is reserved for internal use within the PEmicro interface.

3.17.3.2 SWD Mode Pin Assignments

Cyclone LC programmers also support SWD Mode. This replaces the JTAG connection with a clock and single bi-directional data pin.

20-Pin Standard Connector SWD Mode Pin Assignments

PIN 1 - TVCC	NC* - PIN 2
PIN 3 - TRST or NC*	GND - PIN 4
PIN 5 - NC*	GND - PIN 6

PIN 7 - TMS/SWDIO	GND - PIN 8
PIN 9 - TCK/SWCLK	GND - PIN 10
PIN 11 - NC*	GND - PIN 12
PIN 13 - NC*	GND - PIN 14
PIN 15 - RESET	GND - PIN 16
PIN 17 - NC*	GND - PIN 18
PIN 19 - NC*	GND - PIN 20

Note: *The pin is reserved for internal use within the PE micro interface.

SWD Mode is selected from the “Communication Mode” drop-down box in the Cyclone Image Creation Utility:

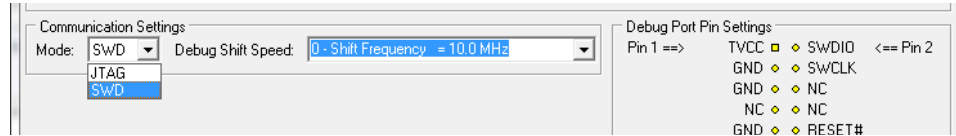

Figure 3-12: Communications Mode Selection

3.17.3.2.1 High-Performance Communications (FX ONLY)

If high-performance options are available for the selected device they will appear in the “Shift Frequency in MHz” drop-down. **Cyclone FX** programmers are capable of high-performance communications when using certain ARM Cortex targets in SWD mode.

Note: **Cyclone LC** programmers cannot currently take advantage of high-performance options, although the frequencies appear in the display.

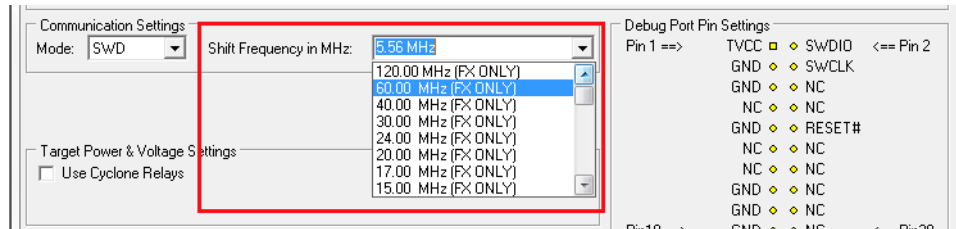

Figure 3-13: High-Performance Options (FX ONLY)

3.18 Target Headers For Part# CYCLONE-LC-UNIV

PE micro Part# CYCLONE-LC-UNIV features 6 ports labeled A-H.

3.18.1 PORT A: 10-Pin Keyed Mini Connector (Kinetis, S32 (ARM), other PE micro-Supported ARM devices)

3.18.1.1 JTAG Mode Pin Assignments

The Cyclone provides a keyed 10-pin 0.050-inch pitch double row connector for ARM targets. The location of the this header is indicated as PORT A in **Figure 3-5**. The 10-pin keyed mini connector pin definitions for JTAG mode are as follows:

10-Pin Keyed Mini Connector JTAG Mode Pin Assignments

PIN 1 - TVCC	TMS - PIN 2
PIN 3 - GND	TCK - PIN 4
PIN 5 - GND	TDO - PIN 6
PIN 7 - NC	TDI - PIN 8
PIN 9 - NC*	RESET - PIN 10

*The pin is reserved for internal use within the PE micro interface.

3.18.1.2 SWD Mode Pin Assignments

Cyclone LC programmers also support SWD Mode. This replaces the JTAG connection with a clock and single bi-directional data pin.

10-Pin Keyed Mini Connector SWD Mode Pin Assignments

PIN 1 - TVCC	TMS/SWDIO - PIN 2
PIN 3 - GND	TCK/SWCLK - PIN 4
PIN 5 - GND	NC* - PIN 6
PIN 7 - NC	NC* - PIN 8
PIN 9* - NC	RESET - PIN 10

*The pin is reserved for internal use within the PEmicro interface.

SWD Mode is selected from the “Communication Mode” drop-down box in the Cyclone Image Creation Utility:

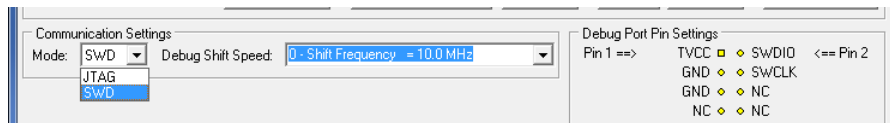

Figure 3-14: Communications Mode Selection

3.18.1.2.1 High-Performance Communications (FX ONLY)

If high-performance options are available for the selected device they will appear in the “Shift Frequency in MHz” drop-down. **Cyclone FX** programmers are capable of high-performance communications when using certain ARM Cortex targets in SWD mode.

Note: **Cyclone LC** programmers cannot currently take advantage of high-performance options, although the frequencies appear in the display.

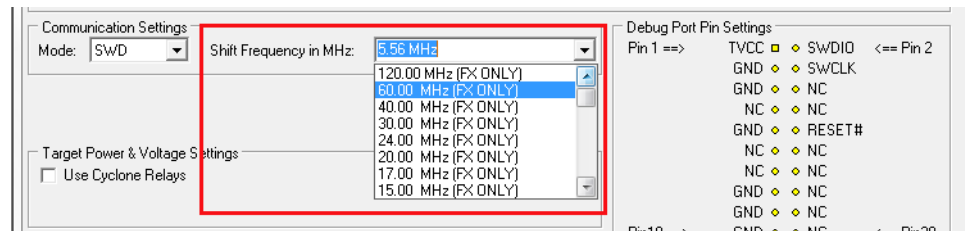

Figure 3-15: High-Performance Options (FX ONLY)

3.18.2 PORT B: 20-Pin Keyed Mini Connector (Kinetis, S32 (ARM), other PEmicro-Supported ARM devices)

3.18.2.1 JTAG Mode Pin Assignments

The Cyclone provides a keyed 20-pin 0.050-inch pitch double row connector for ARM targets. The location of the this header is indicated as PORT B in **Figure 3-5**. The 20-pin keyed mini connector pin definitions for JTAG mode are as follows:

20-Pin Keyed Mini Connector JTAG Mode Pin Assignments

PIN 1 - TVCC	TMS - PIN 2
PIN 3 - GND	TCK - PIN 4
PIN 5 - GND	TDO - PIN 6
PIN 7 - NC	TDI - PIN 8
PIN 9 - NC*	RESET - PIN 10
PIN 11 - NC	NC* - PIN 12
PIN 13 - NC	NC* - PIN 14
PIN 15 - GND	NC* - PIN 16
PIN 17 - GND	NC* - PIN 18
PIN 19 - GND	NC* - PIN 20

3.18.2.2 SWD Mode Pin Assignments

Cyclone LC programmers also support SWD Mode. This replaces the JTAG connection with a clock and single bi-directional data pin.

20-Pin Keyed Mini Connector SWD Mode Pin Assignments

PIN 1 - TVCC	TMS/SWDIO - PIN 2
PIN 3 - GND	TCK/SWCLK - PIN 4
PIN 5 - GND	NC* - PIN 6
PIN 7 - NC	NC* - PIN 8
PIN 9 - NC*	RESET - PIN 10
PIN 11 - NC	NC* - PIN 12
PIN 13 - NC	NC* - PIN 14
PIN 15 - GND	NC* - PIN 16
PIN 17 - GND	NC* - PIN 18
PIN 19 - GND	NC* - PIN 20

*The pin is reserved for internal use within the PEmicro interface.

SWD Mode is selected from the “Communication Mode” drop-down box in the Cyclone Image Creation Utility:

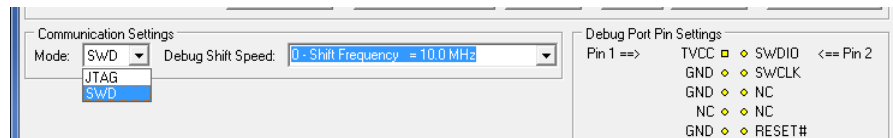

Figure 3-16: Communications Mode Selection

3.18.2.2.1 High-Performance Communications (FX ONLY)

If high-performance options are available for the selected device they will appear in the “Shift Frequency in MHz” drop-down. **Cyclone FX** programmers are capable of high-performance communications when using certain ARM Cortex targets in SWD mode.

Note: **Cyclone LC** programmers cannot currently take advantage of high-performance options, although the frequencies appear in the display.

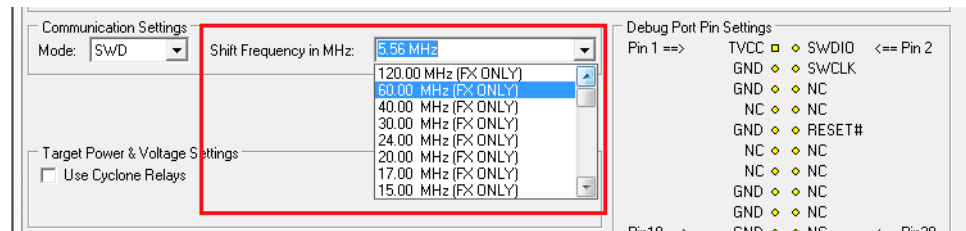

Figure 3-17: High-Performance Options (FX ONLY)

3.18.3 PORT C: 14-Pin Debug Connector (MPC55xx-57xx, SPC5, DSC, S32 (Power))

The Cyclone provides a standard 14-pin 0.100-inch pitch dual row 0.025-inch square header for MPC55xx-57xx, DSC (MC56F8xxx), S32R, or STMicroelectronics’ SPC5 targets. The location of the this header is indicated as PORT C in **Figure 3-5**.

MPC55xx-57xx, SPC5, or S32 (Power) Pinout

TDI	1	2	GND
TDO	3	4	GND
TCK	5	6	GND
NC	7	8	NC

RESET	9	10	TMS
VDDE7	11	12	GND
RDY	13	14	JCOMP

DSC Pinout

TDI	1	2	GND
TDO	3	4	GND
TCK	5	6	GND
NC	7	8	NC/KEY
RESET	9	10	TMS
VDD	11	12	GND
NC*	13	14	TRST

*The pin is reserved for internal use within the PEmicro interface.

3.18.3.1 BERG14-to-MICTOR38 Optional Connector

PEmicro offers a 14-pin BERG to 38-pin MICTOR adapter, sold separately, that may be used on Port C of the **Cyclone LC**. The PEmicro part number is BERG14-TO-MICTOR38.

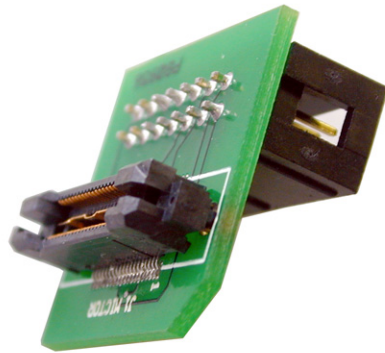

Figure 3-18: BERG14-TO-MICTOR38 Adapter (Sold Separately)

3.18.4 PORT D: 26-Pin Debug Connector (ColdFire V2/3/4)

The Cyclone provides a standard 26-pin 0.100-inch pitch dual row 0.025-inch square header for ColdFire MCF52xx/53xx/54xx family of microprocessors. This port connects to the target hardware using either the ColdFire extension cable for synchronous ColdFire targets such as MCF5272 & MCF5206E (PEmicro part# CABLE-CF-ADAPTER, sold separately), or a standard 26-pin ribbon cable for asynchronous ColdFire targets (included). Please refer to each processor's user manual to identify whether it is a synchronous or asynchronous interface. The location of the this header is indicated as PORT D in **Figure 3-5**.

ColdFire V2/3/4 Pinout

N/C	1	2	BKPT
GND	3	4	DSCLK
GND	5	6	NC*
RESET	7	8	DSI
VCC	9	10	DSO
GND	11	12	PST3
PST2	13	14	PST1
PST0	15	16	DDATA3
DDATA2	17	18	DDATA1

DDATA0	19	20	GND
N/C	21	22	N/C
GND	23	24	CLK
VCC	25	26	TEA

*The pin is reserved for internal use within the PE micro interface.

The ColdFire adapter for Synchronous targets and ribbon cable for Asynchronous targets is pictured below:

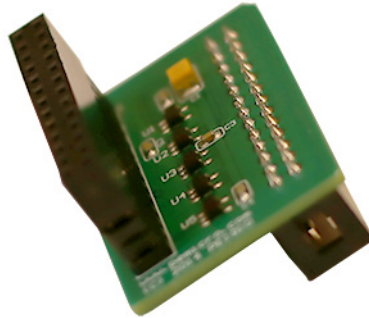

Figure 3-19: ColdFire Adapter (part# CABLE_CF_ADAPTER (Rev. B), for synchronous ColdFire targets, sold separately)



Figure 3-20: ColdFire Ribbon Cable (for asynchronous ColdFire targets, included with Cyclone)

3.18.5 PORT E: 16-Pin Debug Connector (MON08)

The Cyclone provides a 16-pin 0.100-inch pitch double row connector for MON08 targets. The location of this header is indicated as PORT E in **Figure 3-5**. The MON08 header adopts the standard pin-out from MON08 debugging with some modifications. The general pin-out is as follows:

MON08 Signals

PIN 1 - NC*	GND	- PIN 2
PIN 3 - NC**	RST	- PIN 4
PIN 5 - NC*	IRQ	- PIN 6
PIN 7 - NC*	MON4	- PIN 8
PIN 9 - NC*	MON5	- PIN10
PIN11 - NC*	MON6	- PIN12
PIN13 - OSC	MON7	- PIN14
PIN15 - Vout	MON8	- PIN16

*The pin is reserved for internal use within the PEmicro interface.

**The pin is reserved for internal use within the PEmicro interface only when using an MR8 target.

3.18.6 PORT F: 6-Pin Debug Connector (RS08, HCS08, HC(S)12(X), S12Z, ColdFire +/V1, STM8 w/ adapter)

The Cyclone provides a standard 6-pin 0.100-inch pitch dual row 0.025-inch square header for ColdFire V1, S12Z, 68(S)12(X), 68HCS08, RS08, and STMicroelectronics' STM8 targets. The location of the this header is indicated as PORT F in **Figure 3-5**. The header uses the NXP standard pin configuration, listed here for reference:

ColdFire V1, 68(S)12(X), 68HCS08, and RS08 Signals

PIN 1 - BKGD	GND - PIN 2
PIN 3 - NC	RESET - PIN 4
PIN 5 - NC	TVCC - PIN 6

S12Z Signals

Note:* indicates optional signal

PIN 1 - BKGD	GND - PIN 2
PIN 3 - PDO*	RESET - PIN 4
PIN 5 - PDOCLK*	TVCC - PIN 6

6-Pin STM8 Signals

PIN 1 -SWIM**	GND - PIN 2
PIN 3 - NC*	RESET - PIN 4
PIN 5 - NC*	TVCC - PIN 6

*The pin is reserved for internal use within the PEmicro interface.

** All the signals are direct connect except the SWIM line which requires a 680 Ohm pull-up

PEmicro also offers a separate STM8 adapter (part# CU-CUFX-STM8-ADPT) that can be plugged into the 6-pin header of the Cyclone (see **Figure 3-21**). The adapter offers 4 pins signals from an ERNI connector.

4-Pin STM8 Signals

(Requires STM8 Adapter, sold separately)

PIN 1 - TVCC	SWIM - PIN 2
PIN 3 - GND	RESET - PIN 4

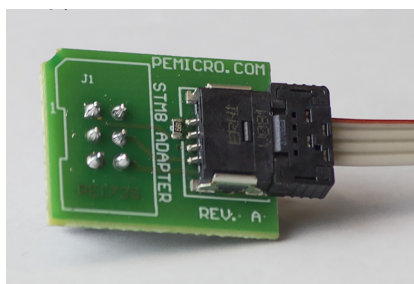
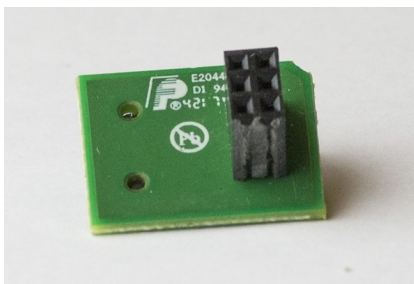

Figure 3-21: STM8 Adapter: 1) Bottom, 2) Top, 3) Connected To 6-Pin Header of Cyclone_Universal (Adapter Sold Separately)

3.18.7 PORT G: 10-Pin Debug Connector (Power MPC5xx/8xx)

The Cyclone provides a standard 10-pin 0.100-inch pitch dual row 0.025-inch square header for Power MPC5xx/8xx BDM targets. The location of the this header is indicated as PORT G in **Figure 3-5**.

Power MPC5xx/8xx BDM Pinout

NC*	1	2	SRESET#
GND	3	4	DSCLK
GND	5	6	NC*
HRESET#	7	8	DSDI
VDD	9	10	DSDO

*The pin is reserved for internal use within the PEmicro interface.

3.18.8 PORT H: 20-Pin Debug Connector (Kinetis, S32 (ARM), other PEmicro-Supported ARM devices)

3.18.8.1 JTAG Mode Pin Assignments

The Cyclone provides a 20-pin 0.100-inch pitch double row connector for ARM targets. The location of the this header is indicated as **PORT H** under Part# CYCLONE-LC-UNIV in **Figure 3-5**. The 20-pin standard connector pin definitions for JTAG mode are as follows:

20-Pin Standard Connector JTAG Mode Pin Assignments

PIN 1 - TVCC	NC - PIN 2*
PIN 3 - TRST or NC*	GND - PIN 4
PIN 5 - TDI	GND - PIN 6
PIN 7 - TMS	GND - PIN 8
PIN 9 - TCK	GND - PIN 10
PIN 11 - NC*	GND - PIN 12
PIN 13 - TDO	GND - PIN 14
PIN 15 - RESET	GND - PIN 16
PIN 17 - NC*	GND - PIN 18
PIN 19 - NC*	GND - PIN 20

*The pin is reserved for internal use within the PEmicro interface.

3.18.8.2 SWD Mode Pin Assignments

Cyclone LC programmers also support SWD Mode. This replaces the JTAG connection with a clock and single bi-directional data pin.

20-Pin Standard Connector SWD Mode Pin Assignments

PIN 1 - TVCC	NC* - PIN 2
PIN 3 - TRST or NC*	GND - PIN 4
PIN 5 - NC*	GND - PIN 6
PIN 7 - TMS/SWDIO	GND - PIN 8
PIN 9 - TCK/SWCLK	GND - PIN 10
PIN 11 - NC*	GND - PIN 12
PIN 13 - NC*	GND - PIN 14
PIN 15 - RESET	GND - PIN 16
PIN 17 - NC*	GND - PIN 18
PIN 19 - NC*	GND - PIN 20

*The pin is reserved for internal use within the PEmicro interface.

SWD Mode is selected from the "Communication Mode" drop-down box in the Cyclone Image Creation Utility:

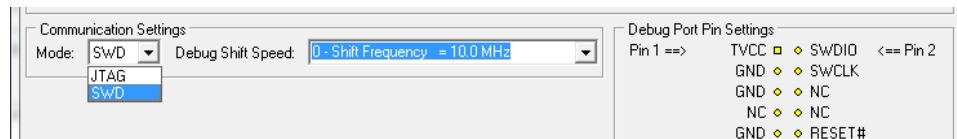

Figure 3-22: Communications Mode Selection

3.18.8.2.1 High-Performance Communications (FX ONLY)

If high-performance options are available for the selected device they will appear in the “Shift Frequency in MHz” drop-down. **Cyclone FX** programmers are capable of high-performance communications when using certain ARM Cortex targets in SWD mode.

Note: **Cyclone LC** programmers cannot currently take advantage of high-performance options, although the frequencies appear in the display.

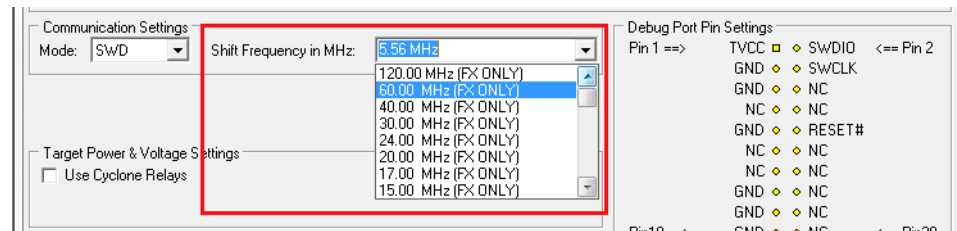

Figure 3-23: High-Performance Options (FX ONLY)

3.19 Ribbon Cable

Cyclone LC programmers communicate with the target through ribbon cables. The ribbon cables for standard debug connectors have a 0.100-inch centerline dual row socket IDC assembly (not keyed). The ribbon cables for 10- and 20-pin mini debug connectors have a 0.050-inch centerline dual row socket IDC assembly (keyed). The ribbon cables are designed such that the Cyclone’s Debug Connector has the same pinout as the Target Header, i.e., Pin 1 of the Cyclone’s Debug Connector is connected to Pin 1 of the Target Header. As an example, **Figure 3-24** sketches the connection mechanism (looking down into the sockets) for a 14-pin ribbon cable. Ribbon cables for other supported architectures use a similar scheme, but may have more or fewer pins.

Ribbon Cable with IDC Socket

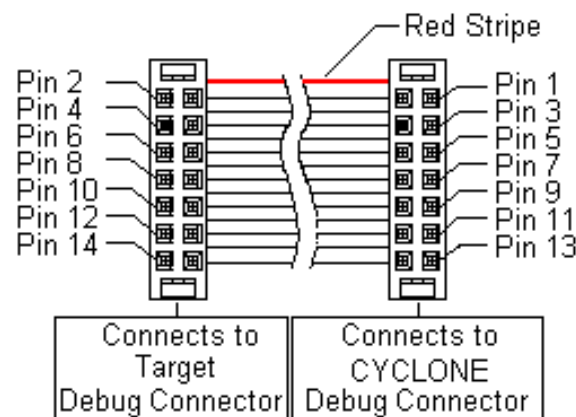

Figure 3-24: Ribbon Cable Example Diagram, When Looking Into IDC Socket

4 TARGET POWER MANAGEMENT

Different target devices may require different power schemes which depend on the design of the target board, target voltages, and even the device architecture. PEmicro has designed the **Cyclone LC** to be capable of powering a target before, during, and after programming. Power can be sourced at many voltage levels from the Cyclone itself, or sourced by an external power supply and switched by the Cyclone.

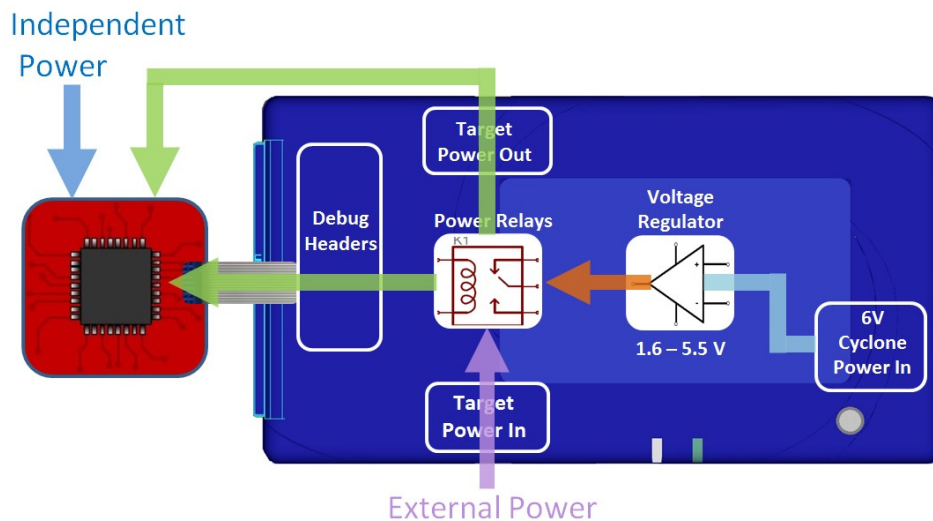

Figure 4-1: Five different paths to power a target

The versatility of the Cyclone power scheme gives the user the utmost flexibility, and includes the following features:

- Provides power through a power jack or through the debug connector
- Provides internally generated voltage from 1.6v-5.5v at up to 500mA
- Switches an external power supply voltage, up to 24V at 1amp
- Selectively powers the target before, during, and after programming
- Powers down the target connections between programming operations
- Uses power switching to aid entry into debug mode for certain targets
- Provides target voltage and current measurement capabilities

If target power is required, each target board may vary where the power is sourced from, externally or internally, and how it is channeled to the target: through the debug header or to a separate connector to the board. Power that is passed through and managed by the Cyclone goes through power relays so it can be power cycled. This is extremely useful because it also allows the power to be off during setup and automatically powered on by the Cyclone for programming. For some devices, the process of entering debug mode requires that the device be powered down and powered back up. Power can also be left in a desired power state, either on or off.

4.1 Cyclone Configuration

There are two different places Power Management is configured and they should be **matched**: first, by the **jumpers** on the **Cyclone LC**, and second, in the **setup** of the programming image. The Cyclone jumpers are the most important because they are the physical connection to the target. The Cyclone has an easy access panel that reveals debug header connections for a variety of different architectures, and a 2x4 jumper block for configuring power management of the target. The specific location of the jumpers is indicated by the label POWER JUMPERS in **Figure 4-3**. This set of 4 jumpers can be used to set 5 different power management schemes for the target.

Note: If these jumpers are not set correctly, the Cyclone will not function as intended.

1	Target is powered independently	
2	Power provided externally (center +) and managed by Cyclone, power out to debug ribbon cable.	
3	Power provided externally (center +) and managed by Cyclone, power out to 2.5 mm output jack (center +)	
4	Power provided by Cyclone, power out to debug ribbon cable	
5	Power provided by Cyclone, power out to 2.5 mm output jack (center +)	

Figure 4-2: Cyclone Power Schemes & Corresponding Jumper Settings

The bottom edge of the **Cyclone LC** has a Power In jack for externally provided power, and the top edge of the Cyclone has Power Out jack, for when power schemes including these are used (see **Figure 4-3**). One of the provided ribbon cables is connected to the appropriate debug header based on the specific target architecture.

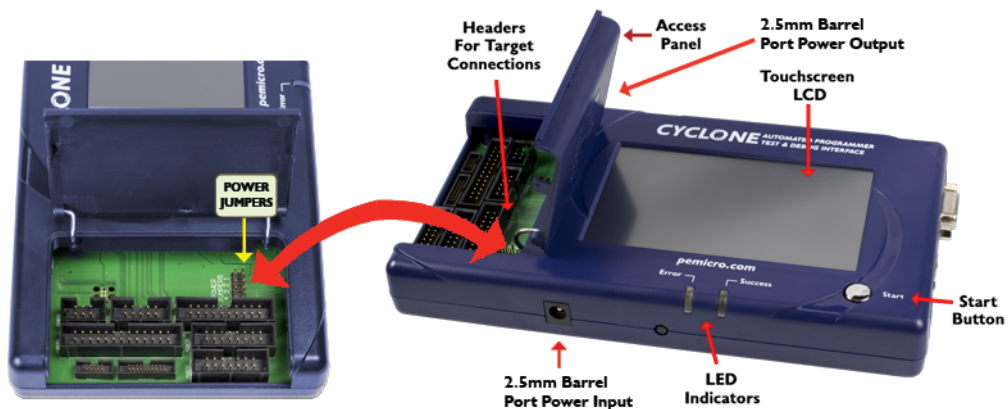

Figure 4-3: Cyclone Hardware Features: Power Jumpers and Target Headers

The power settings that are set by the jumpers are a physical connection and take precedence.

After the basic hardware setup, target power and voltage settings are also set in the creation of a SAP (stand-alone programming) image. At a minimum the SAP image contains all the commands to Erase, Program, and Verify a programming image. More sophisticated power selections in the SAP image can control the relays, target voltage, delays, and power down after SAP operations, as shown in the selection dialog.

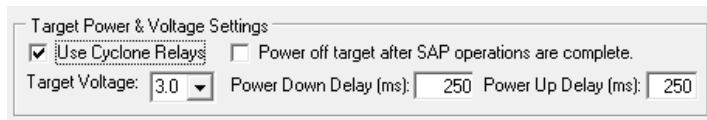

Figure 4-4: Target Power & Voltage Settings

Target voltages (with appropriate jumper settings) in the range of 1.6 to 5.5 volts may be provided. There is also the option to select the internal Cyclone relays to power cycle the Cyclone during programming, and set the length of delays during power up and down. This is extremely useful to make sure the power is off when hooking up the target. Power cycling is especially important for architectures that require it to enter debug mode. The SAP image settings may even be used to turn off the target power once programming is completed, to ensure that the microcontroller is left in a halted state and not running.

4.2 Cyclone Setup

Below is a tutorial that demonstrates how to set up the **Cyclone LC** in each of the 5 power configurations. A very common configuration is the independently powered target. In this power scenario, the Cyclone will detect and use the power on the target for the appropriate debug communication voltages.

4.2.1 Independently Powered Target

In the simplest and most common scenario, no jumpers are set, so the target is powered independently from the Cyclone. No power is passed through the debug header, just the standard debug signals. The Cyclone automatically detects the target power and sets the debug signals to match.

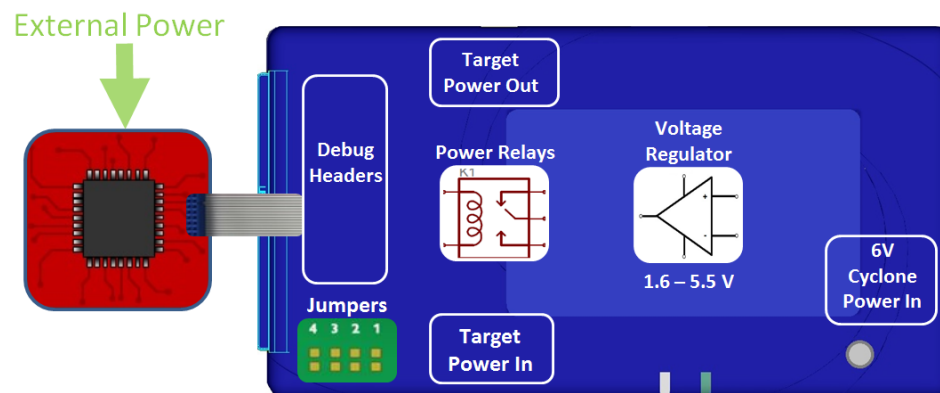

Figure 4-5: Independently Powered Target

4.2.2 Power provided by the Cyclone to the debug cable

It is also possible for the Cyclone to generate power through an internal regulator in the range of 1.6 to 5.5 Volts. In the jumper configuration below, the Cyclone generates the power through a voltage regulator, and passes it through the power relays and out through the debug ribbon cable, which is set up during the SAP image creation. There is only one connection to the target processor which will handle both the communication and the power. In this scenario, external power must not be connected to the Power In jack since it is already being provided.

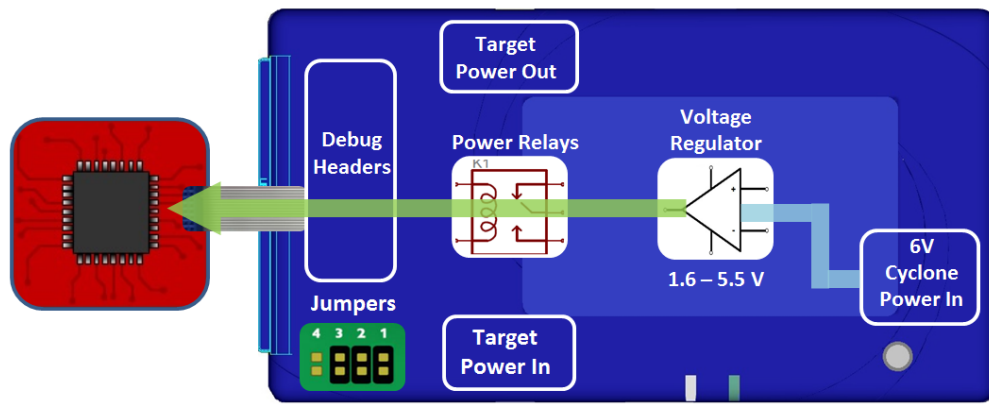

Figure 4-6: Power Provided by the Cyclone to the Debug Cable

4.2.3 External Power passed through the Cyclone and out 2.5 mm barrel port

It is also possible to provide external power, passed through the Cyclone power relays, and back out to be available to power the target board externally. This is useful when the user wants to control the power to the target and the target board has an external power connector. Setting a single jumper will connect the barrel port input connector on the bottom edge of the Cyclone, through the relays, to a matched 2.5 mm barrel port output connector on the top edge of the Cyclone, so that the power can be routed into and back out of the Cyclone.

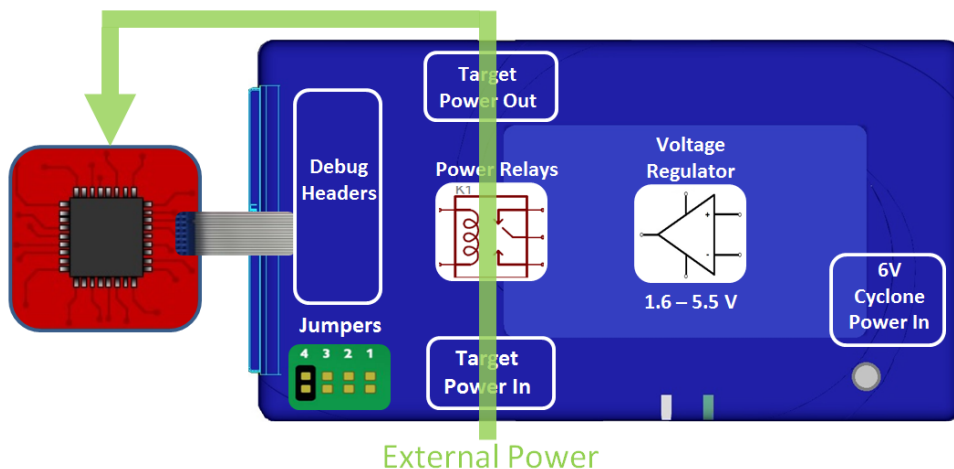

Figure 4-7: External Power Passed Through the Cyclone and Out 2.5 mm Barrel Port

4.2.4 External Power passed through the Cyclone to the debug cable

In a slightly different scenario, the user may wish to provide power to the target through the debug cable. On the bottom edge of the Cyclone is a 2.5 mm Power In port barrel which will pass power through target relays which lets the Cyclone take control of the power cycling during programming. This simple setup requires only an input to the Cyclone and a single ribbon cable connection to the target board that handles both communication and power. The external power provided must be between 1.6 to 5.5 volts.

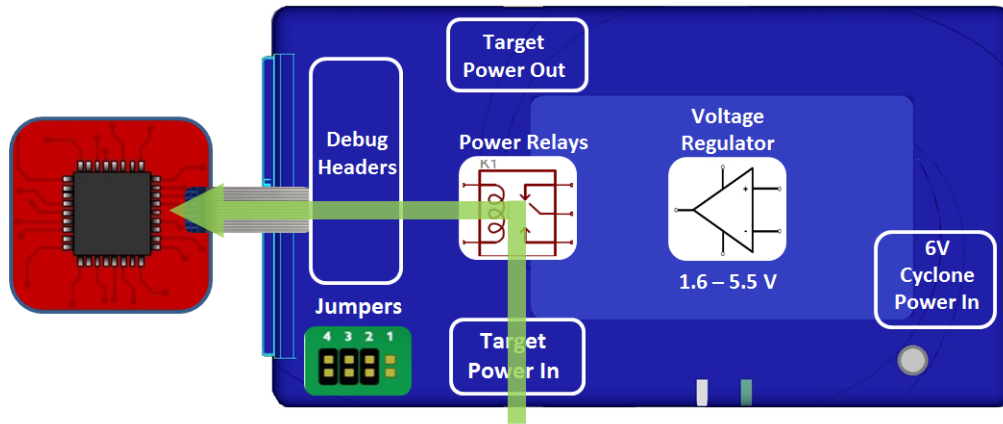

Figure 4-8: External Power Passed Through the Cyclone to the Debug Cable

4.2.5 Power provided by the Cyclone and out 2.5 mm barrel port

In a slightly different scenario, the user may wish to have the Cyclone provide power, but power the target via an external connector on the target. The voltage supplied to the target is determined by the settings in the SAP image. When generating the SAP image the Cyclone relays must be selected as well as the correct voltage level for the target.

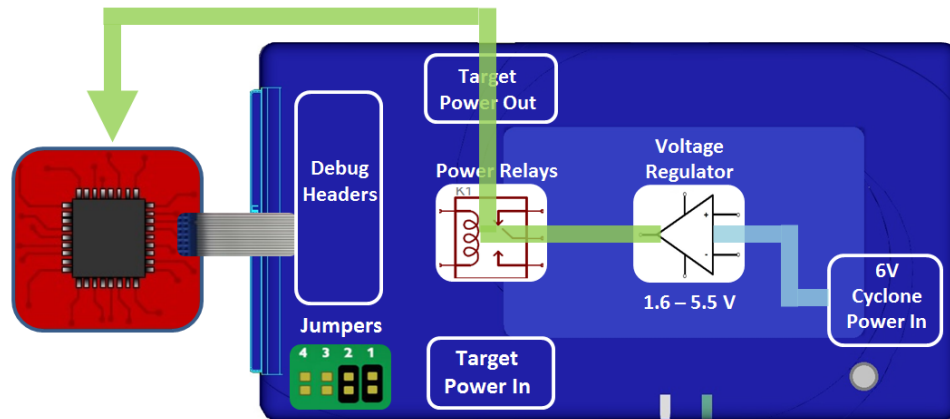

Figure 4-9: Power Provided by the Cyclone and Out 2.5 mm Barrel Port

4.3 Setup Reminders

The most important step when providing power out to a target is to check the Cyclone's **jumper settings** to make sure they match the intended power setup. The jumpers control the power settings which determine how power is supplied, regardless of the SAP image settings. If the jumpers are set for power to be provided through the Cyclone, and the target is externally powered, this is a conflict and may cause damage to the board.

In the case where power is being supplied through the Cyclone and the target is not being powered on, the user should **first check the jumper settings** to make sure they match the intended power setup. Second, the user should check to make sure the SAP image has the 'Use Cyclone Relays' box checked with the appropriate voltage level selected.

5 TOUCHSCREEN LCD MENU

This chapter describes the Cyclone’s touchscreen LCD menu. **Figure 5-1** shows an overview of the menu structure.

Note: This menu will change as features are added to the **Cyclone LC**, so if your menu does not match what is displayed here, please check PEmicro’s website, www.pemicro.com, for a user manual containing the latest LCD Menu operations information.



















5.1 Home Screen

The home screen appears when the **Cyclone LC** is powered on, or when the  Home button is tapped.

5.1.1 Icons

A row of icons in the upper right corner indicates the status of various attributes of the Cyclone.

Note: The user may tap on the row of icons to view the meaning of each of the currently displayed icons.

Cyclone Unit Status: Ok / Bad				
Programming Status: Ready / Busy				
Target Power Relays: On / Off				
USB-To-PC Enumerated: Yes / No				
Real-Time clock Enabled & Working: Yes / No				
Cyclone Power Relays: Closed / Open				
Target Device Is Powered*: Yes / No				
SDHC Memory Card: None / Valid / Unformattd / Reset Cyclone**				

* Target Device Is Powered - “Yes” indicates that the **Cyclone LC** detects power on the Vcc pin of the target device programming header.

** SDHC Memory Card (Requires SDHC Activation License) - “Reset Cyclone” indicates that the Cyclone needs to be reset before the SDHC card will register as Valid. The user can push the Reset button which is located on the front side of the Cyclone, below the LED indicators.

5.1.2 Configurable Display Area

The main area of the home screen can be configured to optionally display the following information, by using the Cyclone IP Configuration Utility (see **Section 5.2.3.5.4 - Configure Home Screen**):

1. Firmware version of the Cyclone (always shown).
2. IP address assigned to the Cyclone.
3. Name assigned to the Cyclone.
4. Number of programming images in the Cyclone’s memory.
5. Name of the selected programming image.
6. First serial number associated with the selected image
7. Current status.
8. Results of the last operation performed.
9. Time and date.

- 10. Status Window and Main Menu button (always shown).
- 11. Programming count & limit
- 12.

5.1.3 Status Window

The status window appears in the lower left corner of the home screen and displays the results of programming operations.

5.1.4 Error Information Icon

When the Cyclone experiences an error during programming operations, the Info icon will appear to the left of the Menu button (or AUX button, if configured).

Info Icon: 

Press the Info icon to view a detailed description of the error.

5.1.5 AUX Button (Appears If Configured)

The Cyclone allows the user to add an Auxiliary (AUX) button to the home screen which will perform a specific function when pressed. The specific function is chosen by the user when the AUX button is configured. The AUX button will appear on the home screen to the left of the “Menu” button, in the lower right corner of the home screen.



Figure 5-1: AUX Button On Home Screen (configured to perform CRC32 function)

For information on how to configure the AUX button, see **Section 5.2.4 - Status**.

5.2 Main Menu

The Main Menu is accessible by pressing the “Menu” button when the Home Screen is displayed. The Main Menu contains the following selections:

Select Programming Image	-	-	-	
Current Image Options	Execute Image Function	Launch Programming	-	
		Verify Data In Target	-	
		Toggle Power	-	
		Power cycle device to run user code	-	
		Validate Image CRC32	-	
	Set Image Validation	Enable Validate IMG	-	
		Disable Validate IMG	-	
	Serial Numbers	UID	-	
		Next Serial # ASCII	-	
		Algorithm ID	-	
CS ID		-		
Show Image Restriction Stats (FX or ProCryption License Only)	-	-		
Configure Cyclone Settings	Edit Cyclone Name	--	-	
	Configure Network Settings	Show Current IP Settings	Current IP Mode IP Mask Gateway MAC Address	
		Edit Static IP Settings	IP Mask Gateway MAC Address	
		Enable/Disable Dynamic IP	-	
		Modify Date/Time	Update Time From Internet	-
			Set Time Zone Hours	-
	Set Time Zone Minutes		-	
	Configure Time Settings	Set Time-Date Display	Display Date Only Display Time Only Display Date and Time	
		Set Date Formatting	YYYY-MM-DD	-
			MM-DD-YYYY	-
			DD-MM-YYYY	-
		Set Time Formatting	MM/DD/YYYY	-
	HH:MM (24-hour)		-	
	HH:MM (AM/PM)		-	
	Configure AUX Button	No operation	-	
		Perform verify only	-	
		Toggle Power	-	
		Validate image CRC32	-	
		Power cycle device to run user code	-	
		Launch image programming	-	
	Configure Screen	Configure Home Screen	Line 2 Display: [...] Line 8 Display:	
		Change Screen Brightness	-	
		Calibrate Screen	-	
		Set Progress Details	Show Progress Details Hide Progress Details Show Details, Keep Last Progress On	
	Configure Storage	Format Internal Storage	-	
		Format External SD Card (FX or SDHC License Only)	-	
	Enable/Disable Start Button	Enable Start Button	-	
Disable Start Button		-		
Configure USB Host Device (FX Only)	Disable	-		
	Enable USB Scanner	-		
Status	Shared Serial Numbers	Choose Serial File to Edit	-	
	Show Current IP Settings	Current IP Mode	-	
		IP	-	
		Mask	-	
		Gateway	-	
	Show Logs	MAC Address	-	
		Show Barcode Scanner Log (FX Only)	-	

Figure 5-2: Main Menu Structure

5.2.1 Select Programming Image

Displays a list of the available programming images so that the user may select one for programming. Images in the Cyclone's internal memory are preceded by the designation "IN" and numbered sequentially, i.e., **IN1**: *first image name*, **IN2**: *second image name*. If the SDHC port of the Cyclone is activated and contains a memory card (and the SDHC License Activation is installed), any programming images that reside on the SD card will be preceded by the designation "EX" in similar fashion.

Encrypted (eSAP) images will display a lock icon to the left of the image description. If the ImageKey needed to decrypt an eSAP image is missing from the Cyclone, the image will appear grayed out, and cannot be selected for programming until the appropriate ImageKey is loaded onto the Cyclone (see image #2 in **Figure 5-3**).

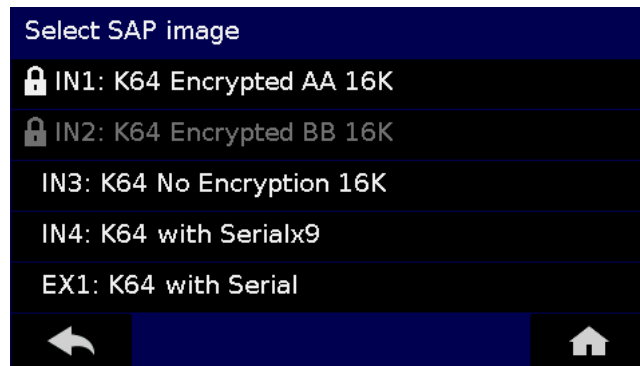

Figure 5-3: Lock Icon Denotes Encrypted Images

You may tap the appropriate image to select it. The image name shown is the one specified in the Cyclone Configuration Utility when saving the image to the Cyclone/SD card.

5.2.2 Current Image Options

This menu presents options that allow the user to select or configure programming images on the **Cyclone LC**.

5.2.2.1 Execute Image Function

Execute Specific SAP Function presents four Stand-Alone Programming functions that you may execute by tapping the function that you wish to execute:

5.2.2.1.1 Launch Programming

This allows the user to execute the programming function. The **Cyclone LC** will program the target device, if able, using the currently selected programming image. This is functionally equivalent to pressing the Start button.

5.2.2.1.2 Verify Data In Target

Performs a verify function on the data that has been programmed into the target device.

5.2.2.1.3 Toggle Power

Toggles the target power and makes sure all ports are driven to debug mode level.

5.2.2.1.4 Power Cycle Device To Run User Code

Toggles the target power and maintains tri-state mode for all signals.

5.2.2.1.5 Validate Image CRC32

Allows the user to perform a CRC32 validation on the currently selected programming image.

5.2.2.1.6 Launch Image Programming

Launches the selected programming image. Replaces the hardware Start Button.

5.2.2.2 Set Image Validation

Allows the user to choose between two validation settings: 1) validate the image each time the Start button is pressed, or 2) do not validate the image.

5.2.2.3 Serial Numbers

Displays the serial number information associated with the currently selected programming image. If there is none, it will display, "This Image Contains No Serial Numbers." There may be one or more Serial Files associated with the image. The user can click on a specific Serial File name to see the following information about that Serial File:

- UID - Unique identifier of the serial number
- Next Serial # ASCII - Next serial number to be programmed (shown in ASCII format)
- Algorithm ID - Displays the algorithm ID of the serial file
- CS ID - Displays the ID of the CS (Choose Serial) command in the SAP file.

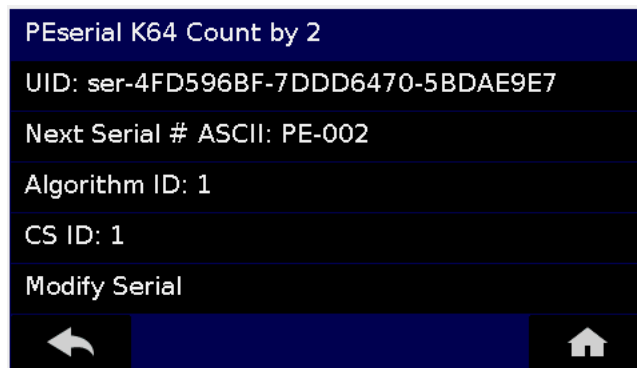

Figure 5-4: Serial File Selection

The user can also click on "Modify Serial Number" to edit that serial number. It is possible to Decrease or Increase the Next Serial by -10, -1, +1, +10. This is often done to address issues in the production process, such as during initial setup.

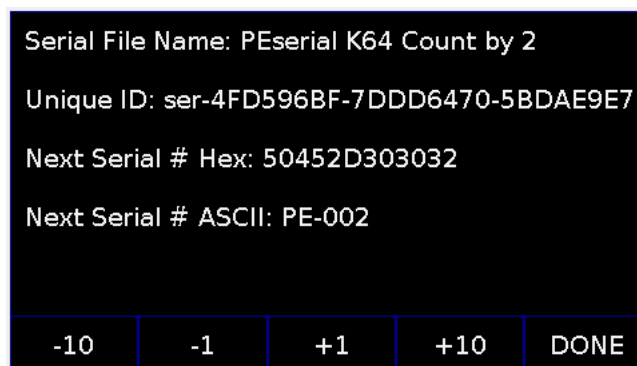

Figure 5-5: Increase or Decrease Serial Number

The adjustment buttons will display "Increase Not Allowed" and "Decrease Not Allowed" if the image/algorithm/CS file that the user has selected does not allow for this operation.

Note: Older serial files are specific to one programming image, unlike PEmicro's current serial files. If viewing Serial Number info for an image that references one or more older serial files, the Cyclone will not show links to the serial files but will instead display serial number info for the first serial file. The user can then Modify Next Serial to change the next serial number, or click MORE at the

bottom to proceed to the next serial file (if any).

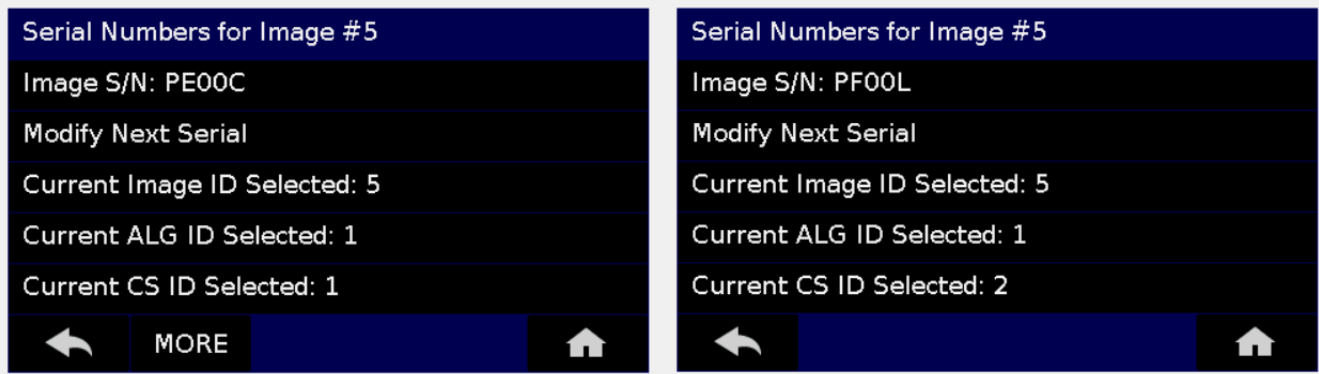

Figure 5-6: Serial Number View With Older Serial Files (CS IDs #1 & #2)

5.2.2.4 Show Image Restriction Stats (Requires FX or ProCryption Security License Activation)

Displays current statistics, if any, for Image Programmed Count & Maximum Allowed, Errors Logged & Maximum Allowed, and Date Range Allowed. These limits can be set in the Security Features section of the Cyclone Image Creation Utility (see **Section 6.1.8.2 - Image Restrictions**).

Note: When *Current Image Stats* is displayed as a home screen item, only Image Programmed Count & Maximum Allowed are displayed on the home screen.

5.2.3 Configure Cyclone Settings

Presents options that allow the user to choose to configure the **Cyclone LC** network settings, time/date settings, and LCD touchscreen display settings, or to set the display to dynamic.

5.2.3.1 Edit Cyclone Name

Allows the user to edit the name of the Cyclone using the on-screen keyboard. Click “Done” to save the new Cyclone name or “Cancel” to exit without saving a new Cyclone name. This name will be displayed on the **Cyclone LC** home screen if the Cyclone is configured to do so.

5.2.3.2 Configure Network Settings

Presents options that allows the user to view or edit various IP settings, toggle the IP settings between static and dynamic, and re-name the **Cyclone LC**.

5.2.3.2.1 Show Current IP Settings

This menu allows you to view the **Cyclone LC** IP address, Mask, and Gateway, and MAC address. You may also tap these entries to edit, as long as the Cyclone is set to Static IP mode.

Dynamic vs. Static

There are two schemes for assigning IP addresses. One is the Static IP addressing mode. This involves the user manually setting the IP address for every device on the network. In this case, it falls to the user to ensure the IPs assigned do not conflict and are within the boundaries of the network. The other is the Dynamic Host Configuration Protocol (DHCP). This involves setting up a separate server to manage the IP addresses. The server is given a list of valid IP addresses for the network. Using a predetermined set of rules, each new device that wishes to connect to the network is given an IP address by the server. This takes the task of managing the validity and uniqueness of IP addresses out of the user's hands and relegates it to the server. **Cyclone LC** programmers are capable of using either Static IP addressing or DHCP.

5.2.3.2.2 Edit Static IP Settings

This menu allows you to edit the Cyclone's IP address, Mask, and Gateway, and view the Cyclone's MAC address. If you are unable to edit these values, you may wish to check to be

certain that the Cyclone is not set to Dynamic IP mode.

IP

Edit IP Numbers allows the user to set an IP number for the Cyclone. The current IP number is displayed on the second line. Tap a number to edit and use the touchscreen keyboard to set the new number. When you are finished, hit Done. If you change your mind and decide not to save, hit Cancel to leave the IP number as is and return to the Main Menu.

Mask

Edit IP Mask allows the user to set an IP Mask for the Cyclone. The current IP Mask is displayed on the second line. Use the Up/Down buttons to scroll through the characters. To select a character, hit the Select button. When you are finished, scroll through the characters until you reach the -> (right-arrow) character. Selecting this character will complete the process. The default IP mask is 255.255.255.0.

Gateway

Edit IP Gateway allows the user to set the IP Gateway for the Cyclone. The current IP Gateway is displayed on the second line. Use the Up/Down buttons to scroll through the characters. To select a character, hit the Select button. When you are finished, scroll through the characters until you reach the -> (right-arrow) character. Selecting this character will complete the process.

MAC Address

Show MAC Address displays the current MAC address for the Cyclone.

5.2.3.2.3 Enable/Disable Dynamic IP

Allows the user to toggle the Cyclone configuration between utilizing a Static IP address or a Dynamic IP address. The user must reset the **Cyclone LC** after changing from Static to Dynamic or vice-versa. The reset button on the front side of the unit may be used.

5.2.3.3 Configure Time Settings (Cyclone Time / Real Time Clock)

The **Cyclone LC** is equipped with a Real Time Clock (RTC) module designed to keep accurate timing even when the Cyclone is turned off. The Date & Time are displayed on the home screen.

This menu presents options that allow the user to configure the Cyclone's various date/time/timezone settings, including formatting options.

5.2.3.3.1 Modify Date / Time

- 1. Update Time from Internet** - Connects to an SNTP server, fetches the current time, and saves it to the Cyclone. When executed it displays a message that this can freeze the Cyclone for up to 3 minutes – This is due to an invalid ARP response due to a bad gateway configuration. Proper configuration will ensure the problem is resolved. If the network connection is not configured/connected this displays a message that the time failed to update. If it is successful no message is displayed.
- 2. Set Time Zone Hours** - Allows you to set the timezone offset, in hours +/-, from GMT time
- 3. Set Time Zone Minutes** - Allows you to set the timezone offset, in minutes +/-, from GMT time

5.2.3.3.2 Set Time-Date Display

Allows you set the Cyclone's Time-Date Display to one of the following configurations:

1. Display Date Only
2. Display Time Only
3. Display Date and Time

5.2.3.3.3 Set Date Formatting

Allows you to select how the date is displayed. The options are:

1. YYYY-MM-DD
2. MM-DD-YYYY
3. DD-MM-YYYY
4. MM/DD/YYYY

5.2.3.3.4 Set Time Formatting

Allows you to select how the time is displayed. The options are:

1. HH:MM (24-hour)
2. HH:MM (AM/PM)
3. HH:MM:SS (24-hour)
4. HH:MM:SS (AM/PM)

5.2.3.4 Configure AUX Button

Allows the user to configure an auxiliary (AUX) button which (if configured) will be labeled appropriately and displayed to the left of the Menu button on the Cyclone's touchscreen LCD. When pressed, the AUX button will perform the task for which it has been configured. The options that may be assigned to the AUX button are:

1. No Operation - No operation is assigned to the AUX button and it will not be displayed on the LCD screen.
2. Perform Verify Only - Verifies the data on the target device against the data in the programming image.
3. Toggle Power - Toggles the Cyclones power relays off/on.
4. Validate Image CRC32 - Validates the CRC32 of the data on the target device against that of the data in the programming image.
5. Power Cycle Device To Run User Code - Toggles the target power and maintains tri-state mode for all signals.
6. Launch Image Programming - Launches the selected programming image. Replaces the hardware Start Button.

5.2.3.5 Configure Screen

This menu presents options that allow the user to adjust or customize the Cyclone's LCD touchscreen display in various ways.

5.2.3.5.1 Change Screen Brightness

Allows the user to adjust the brightness of the LCD touchscreen. The "Increase" and "Decrease" buttons will raise or lower the brightness level, respectively, in increments of 10%. Brightness can be adjusted from between 100% - 10%. Press "Done" to exit.

5.2.3.5.2 Calibrate Screen

Allows the user to click on specified points on the LCD touchscreen in order to calibrate the accuracy of the touch function. Follow the on-screen instructions.

5.2.3.5.3 Set Progress Details

This configures the display to present more detailed information during the progress of programming, including the specific programming steps that are performed and specific information about the programming and verifying procedure. The user may select "Show Details, Keep Last Progress On," "Show Progress Details," or "Hide Progress Details."

5.2.3.5.4 Configure Home Screen

This menu allows you to choose what information to display on Lines 2-8 of the home screen. Available elements to display consist of information such as: the current IP address, the Cyclone name, the number of images, etc. In this way the user can customize the display to provide the information that they find most useful. There is a separate button for each of Lines 2-8. Tapping on the button for a specific Line brings up a list of elements that you can choose to display on that Line of the home screen. If the list of elements is greater than one page, tap the More button to view the rest of the available elements. Tap the element that you want to display on that line and then tap Done to save your selection.

5.2.3.6 Configure Storage

This menu selection allows the user to format the Cyclone's internal memory. This menu will also allow the user to format an SD card located in the Cyclone's memory expansion slot if the SDHC Port Activation License is installed. Select "Format Internal Storage" or "Format External SD Card". The user will be prompted to ensure that they wish to format the corresponding memory. Tap "Yes" to format, or "Cancel" to go back to the previous menu option without formatting the memory.

5.2.3.7 Enable/Disable Start Button

This menu option gives the user the option to disable the physical Start Button. Programming can then be initiated via the Cyclone Control Suite, or by a digital start button on the Cyclone screen if you have the AUX button set to the "Launch Image Programming" option.

The physical Start Button can always be re-enabled via this same menu toggle.

5.2.4 Status

This menu contains a selection that allow the user to view status information regarding various aspects of the Cyclone. This menu will likely be expanded with future updates.

5.2.4.1 Show Current IP Settings

Allows the user to view the Cyclone's Current IP Mode, IP Address, Mask, Gateway, and MAC Address.

6 CREATING AND MANAGING PROGRAMMING IMAGES

The Cyclone Image Creation Utility is used to create programming images which may be loaded into the Cyclone. The user creates programming images based on data sets to be programmed and programming instructions which are all self contained. The next step is to download these programming images to the Cyclone via the GUI, Console, or SDK. Programming can then be launched either manually via the button, or automatically via the Console.exe or SDK. Learn about how to download and launch programming images in **CHAPTER 8 - CYCLONE PROGRAMMER AUTOMATED CONTROL (CYCLONE CONTROL SUITE)**.

Cyclone LC programmers, or **Cyclone LC** programmers with the ProCryption Security Activation License, can also use the The Cyclone Image Creation Utility to encrypt programming images, such that only Cyclones with a specific key can decrypt and program these images. Instructions on how to encrypt using the Cyclone Image Creation Utility are found in **Section 6.1.8.1 - SAP Image Encryption**. A more in-depth description of the encryption process is available in **CHAPTER 11 - SAP IMAGE ENCRYPTION**.

Note: If the user wishes to use a programming image created with an earlier generation Cyclone (such as the Cyclone PRO or MAX, or the Cyclone for ARM devices Rev. A/B) they should first convert the image using the conversion utility described in **CHAPTER 14 - TROUBLESHOOTING**.

6.1 Cyclone Image Creation Utility

This section describes in detail how use the Cyclone Image Creation Utility, shown in **Figure 6-1**, to configure, create, and save a SAP image that will be used for stand-alone programming with the **Cyclone LC**. The **Cyclone LC** does not require a target to be connected when it is being configured. However, the Cyclone must be powered on and one of the communications interfaces must be connected to the Cyclone if an image is to be stored on it.

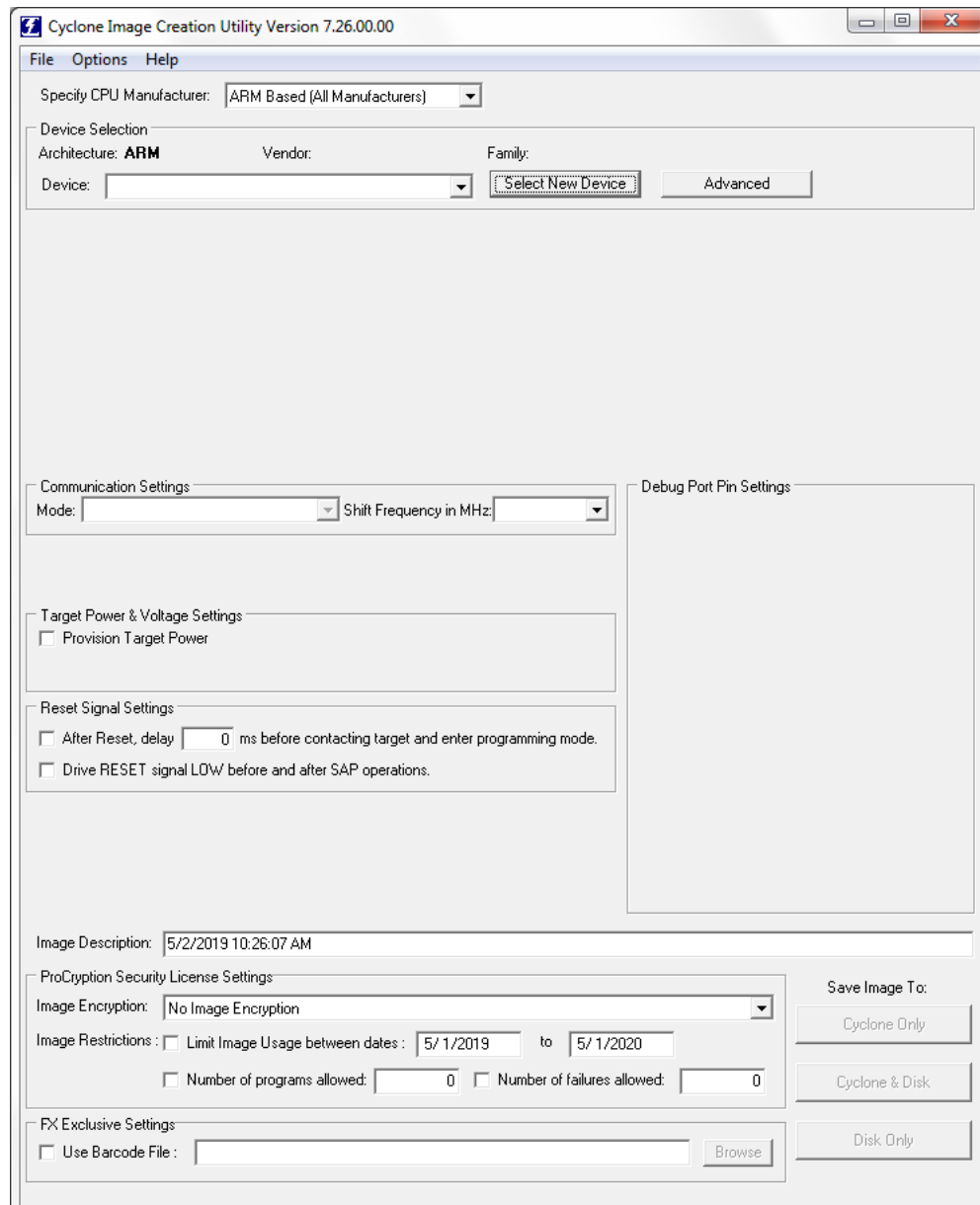

Figure 6-1: Cyclone Image Creation Utility

6.1.1 Specify CPU Manufacturer

The user should select the manufacturer of their target device from the drop-down list.

Cyclone LC programmers support ARM Cortex devices from several manufacturers, including NXP’s Kinetis and LPC devices. For a complete index of PEmicro-supported ARM Cortex devices, please view pemicro.com/arm.

If you are using **PEmicro Part# CYCLONE-LC-UNIV**, this Cyclone also supports these 8-16/32-bit architectures: NXP’s S32, ColdFire® V2/V3/V4, ColdFire+V1, MPC5xx/8xx, MPC55xx-57xx, DSC, ARM® Nexus (MAC7xxx), S12Z, HC(S)12(X), HCS08, HC08, and RS08 devices, as well as STMicroelectronics’ SPC5 & STM8 (**w/ adapter**) devices.

Figure 6-2 shows the Specify CPU Manufacturer drop-down box. The options are:

- ARM-based (All Manufacturers)
- NXP
- STMicroelectronics

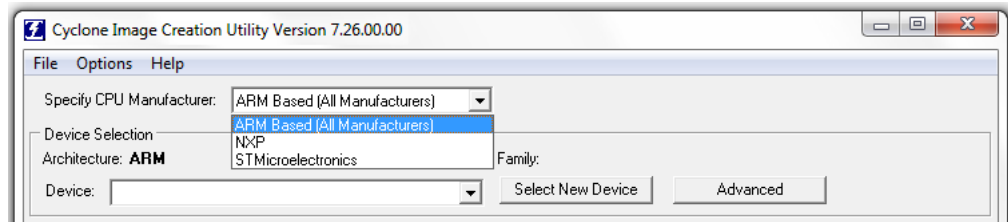

Figure 6-2: Specify CPU Manufacturer

6.1.1.1 ARM-Based Devices

If the user chooses “ARM Based (All Manufacturers)” they should then select their specific device. A recently used device can be selected from the Device drop-down box on the left (see **Section 6.1.1.3 - Device Box**). The user may also click the "Select New Device" button. The Device Selection window will then appear. This dialog directs the user how to navigate the device tree to select their ARM device.

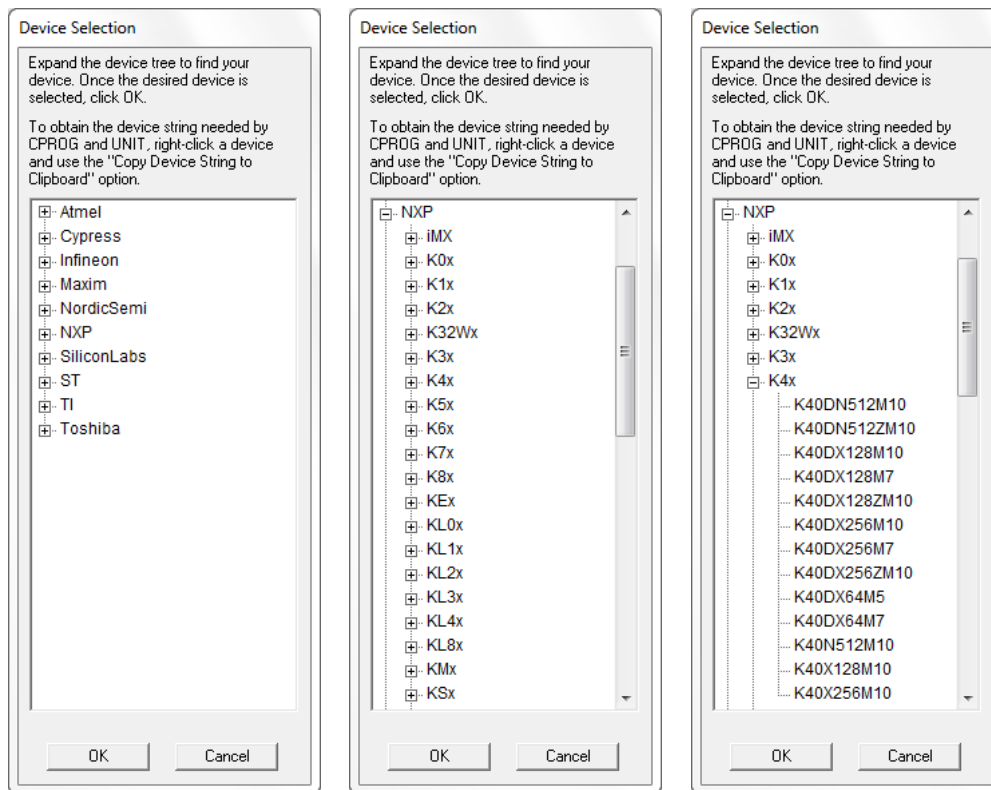

Figure 6-3: Device Selection - Drill Down To Specific Target Device

6.1.1.2 NXP or STMicroelectronics Devices

If the user chooses NXP or STMicroelectronics from the Specify CPU Manufacturer list, they should then select the appropriate architecture from the Specify Target Architecture drop-down.

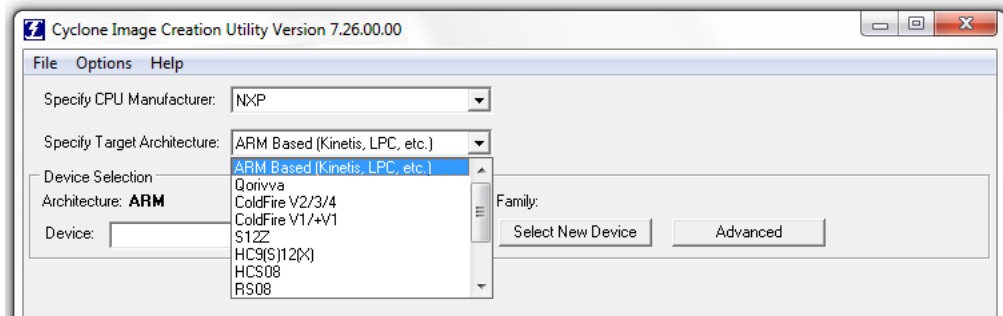

Figure 6-4: Specify Target Architecture (NXP)

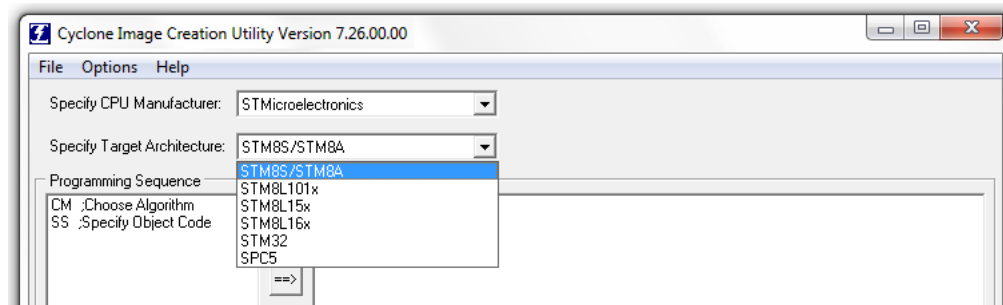

Figure 6-5: Specify Target Architecture (STMicroelectronics)

Note: The user can still select an ARM-based device when using the NXP or STMicroelectronics manufacturer selections.

6.1.1.3 Device Box

The Device box can be used to choose from any devices that have recently been selected.

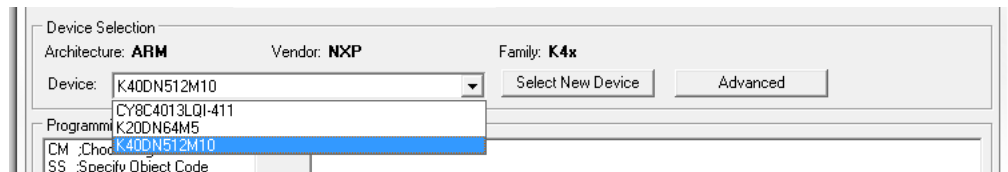

Figure 6-6: Device Drop-Down - Select From Recently Chosen Devices

6.1.2 Security Settings - Qorivva (MPC55xx-57xx) Only

If your selected target architecture was Qorivva (MPC55xx-57xx), the Cyclone Image Creation Utility will display an area called Security Settings (see **Figure 6-7**). If your MPC55xx-57xx device supports uncensoring, click the “Device supports uncensoring” checkbox and select the appropriate bit depth for the device’s password (64-bit or 256-bit). The box to the right is where the password must be entered. Optionally you may use the Browse button to navigate to a text file that contains the correct password for the device. The contents of the text file that you select will automatically be used to fill the password text box.

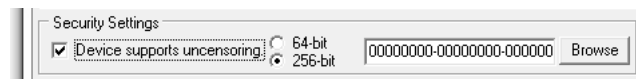

Figure 6-7: Security Settings - Qorivva (MPC55xx-57xx) Only

6.1.3 Programming Sequence

This is the two-panel interface directly below the Device Selection area. This is where the user creates the sequence of commands to be carried out during programming. The left panel provides a list of available programming functions. The right panel displays the ordering of the functions.

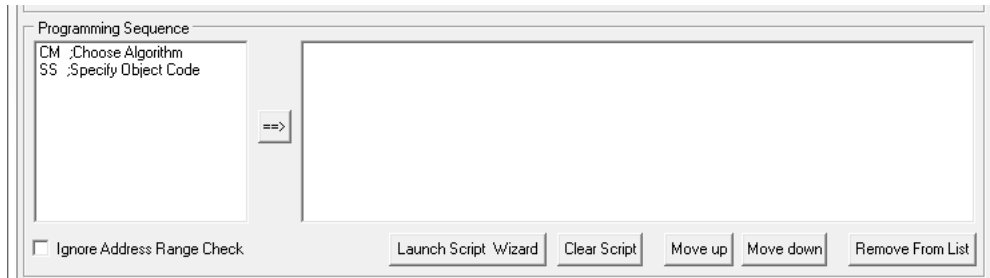

Figure 6-8: Specify Programming Sequence

There are two ways to create the programming sequence.

6.1.3.1 Manual Selection

The user can individually specify the algorithm and the object code and then add commands. To specify the programming algorithm for the target, double-click on the Choose Algorithm (CM) function in the left panel. Or, it can be highlighted and added it to the right panel using the arrow (->). This opens the “Specify Programming Algorithm to Use” dialog.

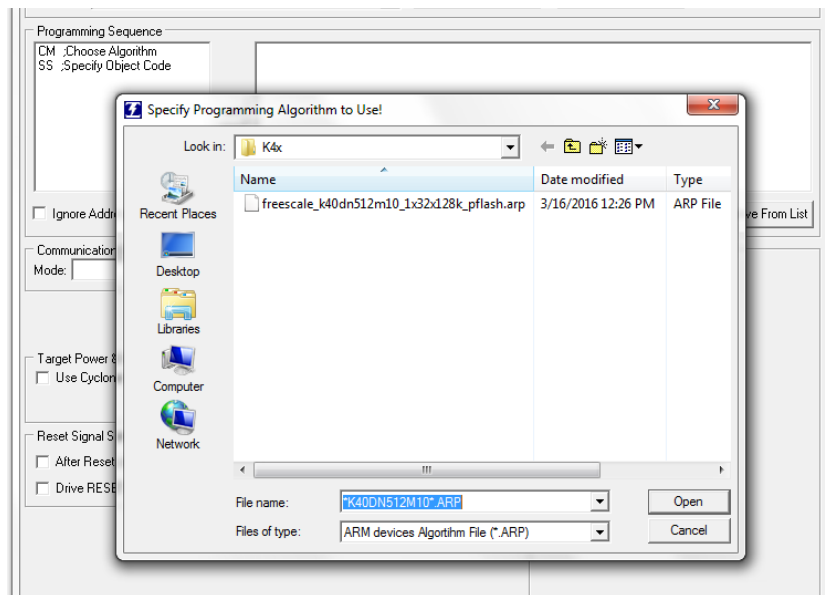

Figure 6-9: Specify Programming Algorithm To Use

The user should select the programming algorithm to be used. Once the algorithm is selected, the full list of programming functions becomes available in the left panel.

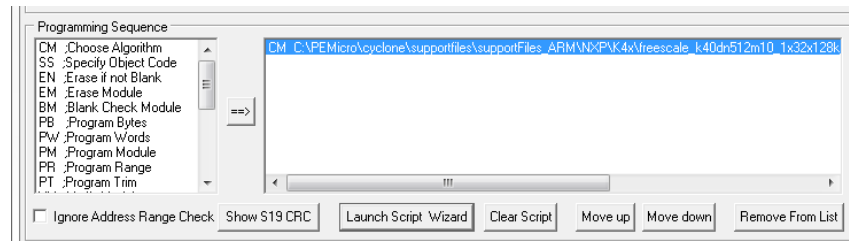

Figure 6-10: Programming Functions Available

Similarly, to specify the S-Record to be programmed into the target, the user may double-click on Specify Object Code (SS) in the left panel or highlight it and add it using the arrow (->). This opens a dialog which allows you to select the appropriate S-Record.

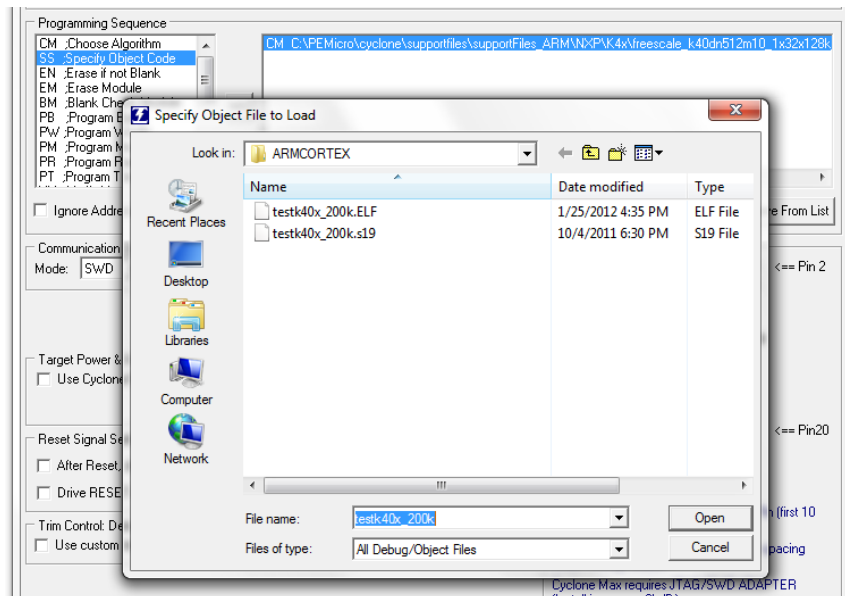

Figure 6-11: Specify Object File To Load

Next, the user would add additional programming functions to complete the programming script by selecting programming operation commands from the Programming Sequence area. See **Section 6.1.4 - Programming Operations** for a description of these commands. The commands can be added by double-clicking them, or by selecting them and using the arrow (->). Commands can also be removed or resequenced; see **Section 6.1.3.3 - Function Buttons**.

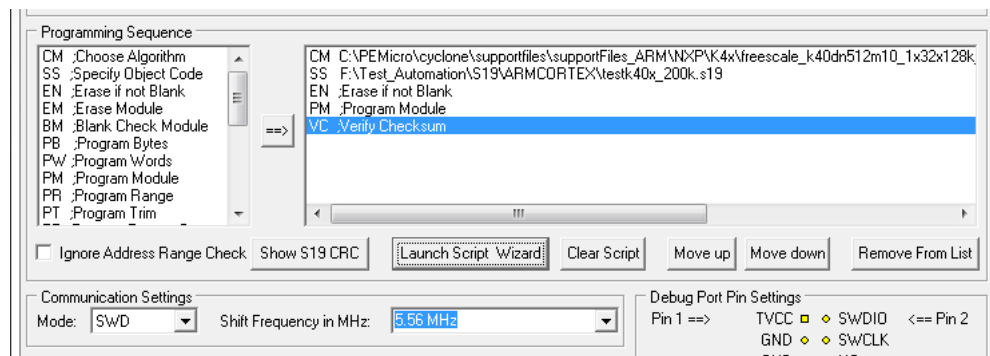

Figure 6-12: Add Programming Functions

6.1.3.2 Script Wizard

Another method that can be used to create a programming sequence is the Launch Script Wizard button.

Note: Launch Script Wizard removes any commands that are already in the programming sequence window and begins a new sequence.

The Launch Script Wizard button will automatically prompt the user for a programming algorithm, followed by an object file, and then adds commands (EN - Erase if not blank, PM - Program module, VC - Verify Checksum) to create a default programming script. The user can then use the programming commands on the left and function buttons to modify the programming sequence as needed.

6.1.3.3 Function Buttons

The arrow (->) will add the selected programming commands to the end of the programming sequence. Double-clicking the command has the same effect.

The Clear Script button will remove all programming commands from the right panel.

The Move Up and Move Down buttons allow the user to manually re-sequence the order of the

programming commands.

The Remove From List button can be used to remove a selected command from the right panel. The user can also simply hit the Delete button on their keyboard when the command is selected in the programming sequence.

6.1.3.4 Programming Sequence Complete

Once the programming sequence is complete, the programming image can be saved to a disk or to the Cyclone unit. For more information, please see **Section 6.1.10 - Store Image To Cyclone**.

6.1.4 Programming Operations

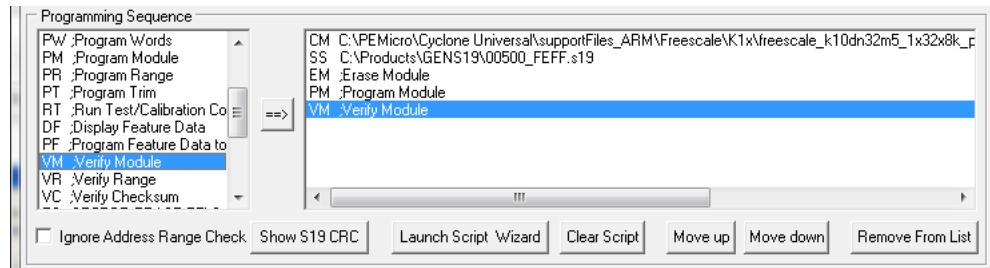

Figure 6-13: Programming Operations Dialog Section

The Programming Sequence field, the user may specify the algorithm, object file, and operations to be carried out.

6.1.4.1 Choose Module

Presents a list of available programming files. Each programming file contains information on how to program a particular module. Usually, the name of the file indicates what kind of module it relates to.

6.1.4.2 Specify Object File

Asks for the name (and/or path) to a file of object files to be used in programming or verifying a module. If the file is not found, an error message is given. The currently-selected file is shown in the S19 file selected window. The programmer accepts S1, S2, and S3 records. All other file records are treated as comments. If you do not specify a file-name extension .S19 is used by default. The programmer also supports ELF/Dwarf 2.0, 3.0, and 4.0 object files.

Your .S19 file may contain data for both EEPROM and flash. If you know that your S19 file contains the correct data, “Ignore S19 Range” may be checked. This will cause any out of range errors to be ignored.

6.1.4.3 Erase If Not Blank

This command performs a blank check of the module and erases it if it is not blank.

6.1.4.4 Erase Module

If “Erase Module” is specified, the Cyclone will erase the EEPROM/flash on the target device after entering the Monitor Mode or BDM mode.

6.1.4.5 Blank Check Module

If “Blank Check Module” is checked, the Cyclone will check to see if the flash/EEPROM on the target device is erased.

6.1.4.6 Program Bytes

Prompts for a starting address, which must be in the module. You are then asked to enter in hexadecimal a byte to be programmed into the current location. Clicking the OK button will automatically advance to the next data byte location.

6.1.4.7 Program Words

Prompts for a starting address, which must be in the module. You are then asked to enter, in hexadecimal, a word to be programmed into the current location. Clicking the OK button will automatically advance to the next data word location.

6.1.4.8 Program Module

This command will program the selected S-record file into EEPROM/flash. For this command to work, you must have previously selected an S-record file.

6.1.4.9 Program Feature Data

The Program Feature Data option on the Cyclone Image Creation Utility gives the user more options to program dynamic data programming on the target device. To use Program Feature Data select the "PF" command when creating a programming image. A window will show you the options for feature data to program.

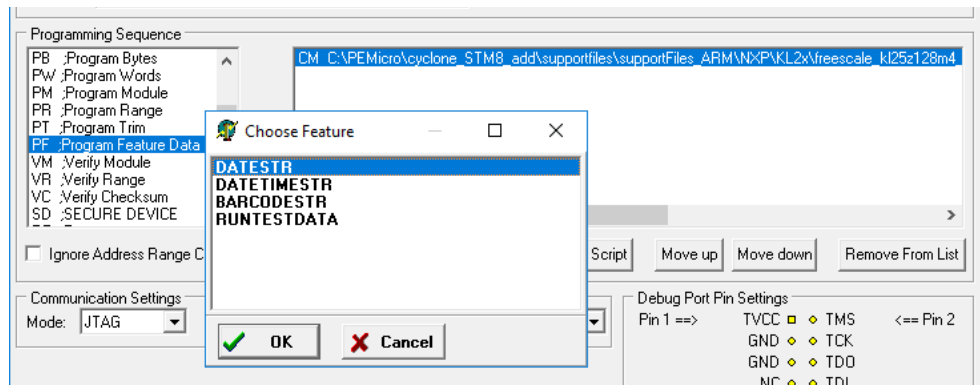

Figure 6-14: Using PF Command (Dynamic Data)

The options can be 1) a string of the current date (YYYY-MM-DD), 2) a string of the current date and time, 24-hour clock (YYYY-MM-DD HH:MM:SS), 3) run test data.

Cyclone FX only: To 4) program the barcode into the flash of the target device, BARCODESTR should be selected. The next window contains the hex address of where the dynamic data will be stored:

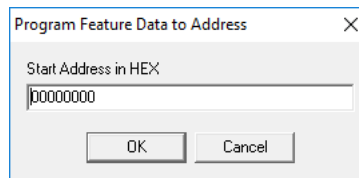

Figure 6-15: Program Feature Address Dialog (Hex)

6.1.4.10 Verify Module

This command will verify that the selected S-record file was programmed into the EEPROM/flash. For this command to work, you must have previously selected an S-record file.

6.1.4.11 Verify Checksum

This command verifies the module content via a CRC calculation. This command is typically much faster than performing a full Verify Module command.

6.1.4.12 Choose Serial File

This command becomes available once a programming algorithm is selected. It specifies the serial file that holds the serial numbers to be programmed to the target.

6.1.4.13 Program Serial Number

This command becomes available once a programming algorithm is selected. It will instruct the Cyclone to program the serial number to the target once executed. As with other commands, the serial number will not be programmed until the SAP operations are carried out.

Note:

6.1.5 Communication Mode and Rate Settings

Cyclone LC programmers support multiple communication modes and communication rates. A user needs to select proper communication mode and rate from the drop down list after programming operations are specified. The debug connector pin definitions are listed for reference.

6.1.6 Target Voltage and Power Settings

A user may elect to use Cyclone to supply power to the target. In this case, the Target Voltage specifies the target MCU I/O voltage level.

The user needs to take into account the power discharge time for the Power Down delay. The reset driver delays, power stabilization time, and the target clock stabilization time should be considered for the Power Up delay.

A checkbox is available for a user to instruct the Cyclone to turn off target power after SAP operations. If unchecked, the target power will remain on.

The user has the option to provide Reset Delay if certain reset monitoring devices are used. The Cyclone will delay for the specified time after allowing the target out of reset.

6.1.7 Image Description

The Cyclone Image Creation Utility allows the user to summarize the purpose of their current configuration for future reference by adding text to the Image Description box. The description will be either programmed into the Cyclone or saved into an encrypted file.

The image description will appear on the Cyclone's touchscreen LCD for image identification. This field will not affect the Cyclone's operations with the target.

Tip: If your image will be encrypted, it can be helpful to indicate this as part of the Image Description.



Figure 6-16: Image Description Box

6.1.8 ProCryption Security License Features

Cyclone FX programmers, and **Cyclone LC** programmers with the ProCryption Security Activation License installed, can take advantage of the powerful security features that can be configured in this area of the Cyclone Image Creation Utility.

6.1.8.1 SAP Image Encryption

Users can create unique ImageKeys which can be used to encrypt their programming images. SAP images encrypted in this way can only be loaded onto a Cyclone that has been provisioned with the identical ImageKey.

Note: Both the Cyclone and the ImageKey are needed to decrypt the image. If the ImageKey is later removed from the Cyclone, the encrypted SAP image cannot be decrypted for programming. Likewise, the encrypted image cannot be read on a PC.

This section will detail how to use the Cyclone Image Creation Utility to encrypt a SAP image. For a more in-depth description of Cyclone SAP image encryption, please see **CHAPTER 11 - SAP IMAGE ENCRYPTION**. For detailed information about how to use and manage encrypted programming images during the production process, the user should refer specifically to **Section 11.4 - Managing Encryption For Production Programming**.

6.1.8.1.1 Creating an ImageKey

If an ImageKey has not been created or a new ImageKey is required, the user should select the “Image Encryption” combo-box in the Cyclone Image Creation Utility and choose the “Create Image Encryption Key...” option.

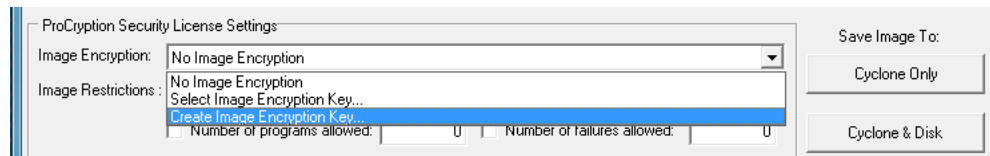

Figure 6-17: Create Image Encryption Key - Drop Box

This will pop up a box asking for a descriptive ImageKey Name (this name will be used for display in many dialogs):



Figure 6-18: Create ImageKey

After entering the name, the user should click Generate Encryption Key. This will bring up a dialog which allows the user to choose the save location:

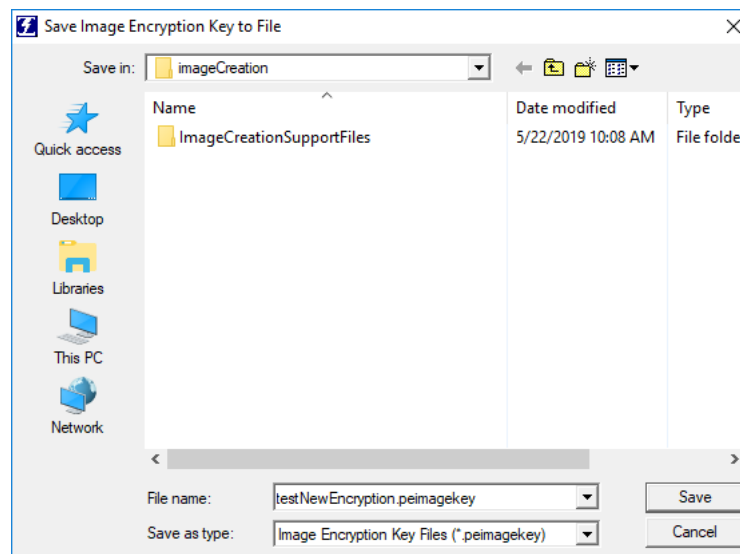

Figure 6-19: Save Image Encryption Key To File Dialog

The user should navigate to the desired location and then click "Save". The ImageKey will be generated and automatically selected in the Cyclone Image Creation Utility, such that generating an image will use this ImageKey for encrypting.



Figure 6-20: ImageKey Selected After Creation

Note: Every ImageKey created is unique and may not be recreated. This means that once generated, the user should keep the ImageKey in a secure place. Users may also wish to keep track of which SAP images have been encrypted with each ImageKey, as the current software does not track this information.

By default, the ImageKey will stay selected in the Image Creation Utility. If a different ImageKey is required for encryption, or the user does not wish to encrypt their SAP image, the corresponding change may easily be selected using the drop-down box.

6.1.8.1.2 Encrypting A SAP Image

To create an encrypted programming image, the user sets up their parameters in the Cyclone Image Creation Utility as usual, and then simply selects the desired ImageKey in the "Image Encryption" combo-box.

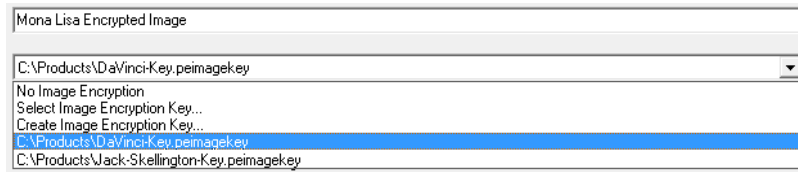

Figure 6-21: ImageKey Selection

The image will automatically be generated as an encrypted image, encrypted with the selected ImageKey. An encrypted stand-alone programming image is called an eSAP (Encrypted Stand Alone Programming) file. This eSAP file may be downloaded to any Cyclone which has been provisioned with the same ImageKey (i.e. the ImageKey has already been added to the Cyclone). This is discussed in **Section 11.4.1 - Provisioning a Cyclone with an ImageKey**.

6.1.8.2 Image Restrictions

There are any number of reasons why the user may want to place restrictions on the use of specific programming images on a Cyclone programmer: from added ease when managing production to a desire to protect intellectual property.

Cyclone FX programmers and **Cyclone LC** programmers with the ProCryption Security Activation License are able to restrict the use of programming images via the associated fields in the Cyclone Image Creation Utility.

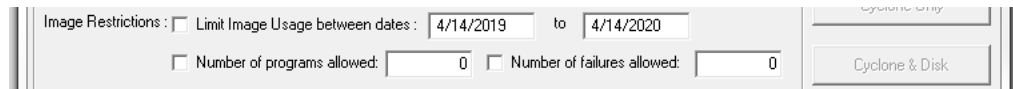

Figure 6-22: Image Restrictions

This area allows you to specify one or more restrictions and tie them to specific programming images. Even if restricted programming images are deleted from Cyclone’s internal memory or an SD card, the Cyclone platform has a persistent memory that continues to tie security restrictions to that programming image. Thus, if an image is removed and re-added to a Cyclone, the image counts are maintained and would continue counting from where it left off. Also, if the SD Card is moved from Cyclone to Cyclone, the count is maintained in both Cyclones as well as the SD Card.

Every time an image is generated by the Cyclone Image Creation utility, it is encoded with a unique image ID number. All counts are stored relative to this unique ID number. So, when an image is regenerated in the Cyclone Image Creation utility, it will have its own counts which will not conflict with the previously generated image, even if the images are otherwise exactly the same. In this way, the user can regenerate an image to allow a new batch of targets to be programmed.

Note: The user may set more than one type of restriction on a programming image. The ability to program the image will be restricted by whichever triggers first. E.g., if the user creates settings to allow 100 programs, and also sets an allowed date range restriction, the ability to program the image will be restricted as soon as the first of these conditions is triggered.

Currently the user may set the following restrictions:

6.1.8.2.1 Limit Image Usage Between Dates

When “Limit Usage Between Dates” is checked and the start and end dates are specified with valid dates (format: DD/MM/YYYY), the Cyclone operator will only be allowed to program the

corresponding programming image when the date is on or between the dates specified. The Cyclone has an onboard battery and clock which keeps a clock running even when power to the Cyclone is removed. This clock date is the one used for comparison to the UTD Date specified in the image. The ability to limit programming to a date is useful for making sure that an image will stop working after a period of time. This could be for security purposes, or to make sure that a new and updated image will need to be uploaded to the Cyclone after a period of time (for instance, to not allow a firmware more than a year old to be programmed onto a target).

6.1.8.2.2 Limit Number of Programs Allowed

When “Limit Number of Programs Allowed” is checked and a number is specified in the corresponding box (minimum = 1), the Cyclone operator will only be able to execute a number of successful programming operations of this programming image less than or equal to the number specified. The current programming count can be displayed on the main screen of the Cyclone or it can be seen on the image’s statistics page (see **Section 6.1.8.2.4 - Image Restriction Statistics**).

6.1.8.2.3 Limit Number of Failures Allowed

When “Limit Number of Failures Allowed” is checked and a number is specified in the corresponding box (minimum = 1), the Cyclone operator will only be able to execute programming operations on the current image until the maximum number of errors specified has been reached. This restriction exists largely to prevent an operator from intentionally generating an error as part of the programming process in an attempt to circumvent the count restrictions. A recommended limit on this number would be on the order of 5% of the allowed programming counts.

6.1.8.2.4 Image Restriction Statistics

Statistics related to any specified restrictions for the currently selected programming image may be viewed by navigating in the touchscreen menu to *Current Image Operations - Show Current Image Stats*. For more information on viewing programming image stats, see **Section 5.2.2.4 - Show Image Restriction Stats (Requires FX or ProCryption Security License Activation)**.

In addition, the statistics for Number of Programs & Maximum Allowed can be set to display on the home screen by navigating in the touchscreen menu to *Configure Cyclone Settings -> Configure Screen -> Configure Home Screen*. For more information on how to configure the Cyclone’s home screen, see **Section 5.2.3.5.4 - Configure Home Screen**.

6.1.9 FX Exclusive Features

This area contains a hardware feature that is exclusive to the **Cyclone FX**, and as such cannot be licensed by **Cyclone LC** programmers.

6.1.10 Store Image To Cyclone

“Store Image to Cyclone” allows the current configuration to be programmed into the Cyclone. The Cyclone will then be ready for operations. After you click “Store Image To Cyclone,” the Cyclone Control GUI will pop up so that you can choose the Cyclone onto which you wish to save the SAP image.

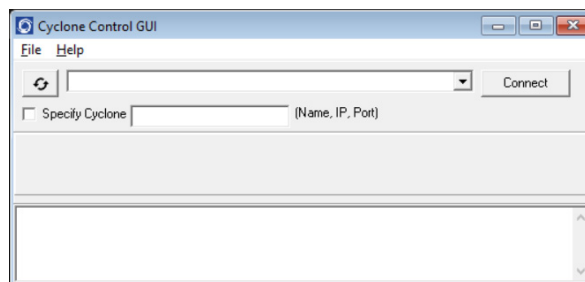

Figure 6-23: Cyclone Control GUI: Choose Cyclone for Stored Image

The Cyclone Control GUI drop-down list allows the user to select from all the Cyclones available.

In the case of a Cyclone present on a different network (i.e., not displayed automatically in the drop-down list), the user may specify its IP address by using the Specify Cyclone checkbox and typing the identifier of the Cyclone.

Click on "Connect" to access the specified Cyclone. A click on the "Apply Changes" button will then store the image on the selected Cyclone.

6.1.11 Store Image To Disk

"Store Image To Disk" allows the current configuration to be saved onto the hard drive. The image can then be transferred to the Cyclone's internal flash (or an installed SD card) via the Manage Images Utility.

6.1.12 Save Cyclone Configuration

"Save Cyclone Configuration," in the file menu, allows the user to save the configuration into a file, which may be used for future reference, e.g., comparing the Cyclone contents with the file to see if they are the same.

6.1.13 Load Cyclone Configuration

"Load Cyclone Configuration" in the file menu allows the user to load a configuration that has previously been saved in order to create a new image.

6.2 Managing Multiple SAP Images

The Cyclone Control GUI, shown below in **Figure 6-25**, allows the Cyclone to store and manage multiple images in the Cyclone's internal memory and - on a **Cyclone FX** or a **Cyclone LC** with the SDHC Port Activation License installed - on any compatible memory card that is loaded into the SDHC port (**CYCLONE** programmers require SDHC License Activation).

Any programming images that have been created and saved to the disk using the Cyclone Image Creation Utility may be loaded collectively onto the Cyclone, with one exception. Encrypted images may only be loaded if their ImageKey resides on the Cyclone.

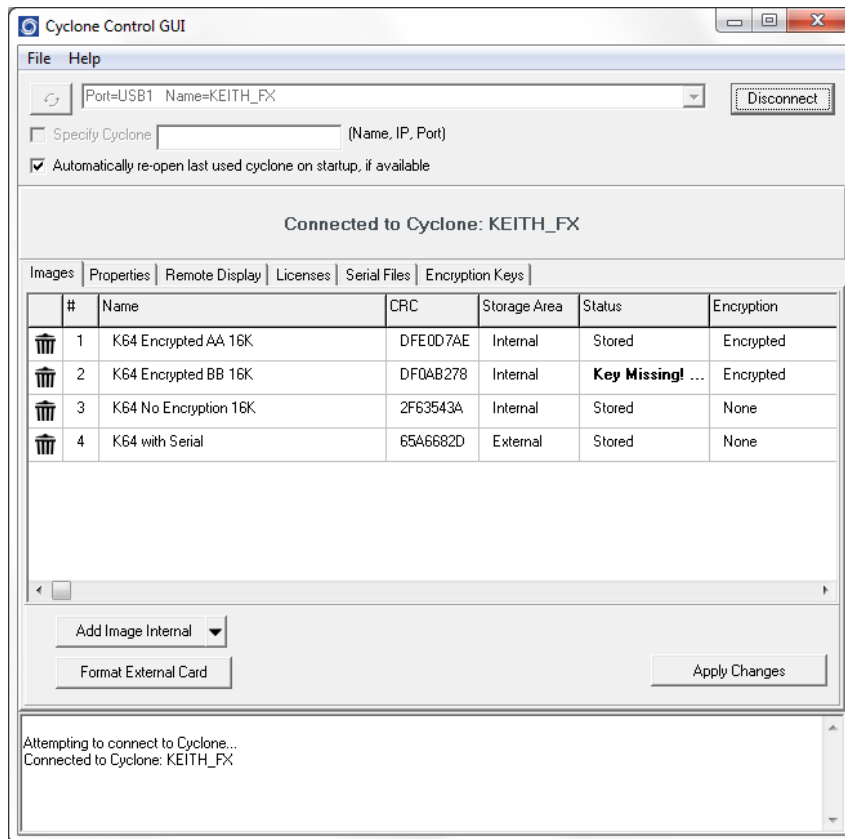

Figure 6-24: Manage Images Utility

Upon opening a selected Cyclone in the Cyclone Control GUI, the user is provided in the first tab with a list of the images currently on the unit's internal memory which are marked with a **Storage Area** label of "Internal". A list of images on any installed SDHC card will also be displayed with a **Storage Area** label of "External"

You can add images with the "Add Image Internal" button under the images panel. These images will appear with a "Status" label of "Ready to Store". These images are not yet in the Cyclone, the "Apply Changes" button will have to be clicked for the changes to take effect.

If the Cyclone's SDHC port is activated, the user can also add images to the external memory by using the drop-down next to the "Add Image Internal" button and selecting "External". Alternatively, once an image has been added to the proposed changes and it is in the "Ready to Store" state, the user may right click on the image and click the "Switch storage to External" option.

In **Figure 6-25**, note that the **Encryption** area displays "Encrypted" or "None" to indicate whether or not each programming image is has been encrypted. The **Status** area will display "Key Missing!" if the ImageKey for an encrypted image has been removed from the Cyclone.

For information on how to encrypt SAP Images and the significance of the ImageKey, please refer to **Section 6.1.8.1 - SAP Image Encryption**. For an overview of Cyclone SAP Image encryption and the process of using encrypted images in the production process, please see **CHAPTER 11 - SAP IMAGE ENCRYPTION**.

6.2.1 Delete Images From Internal/External Memory

Any images that are already stored on the Cyclone or installed SD card can be deleted by just clicking on the trash can on the left of the image or by selecting the image and clicking the Delete key on the keyboard, the image status will be changed to "Ready to Erase." The image will be removed after "Apply Changes" is clicked.

6.2.2 Add/Remove Images From The Commit Changes Panels

Once the images that you wish to load appear in the images tab, you must press "Apply Changes"

to update the Cyclone accordingly. No actual updates will occur to the Cyclone's internal/external memory or installed SD card until the user selects "Apply Changes.

Note: Any SAP images that are already stored on older Cyclone models such as the Cyclone PRO, MAX, Renesas, STMicro, or Cyclone LC ARM - Rev. A/B (or on a CompactFlash card in one of those units, if applicable) can not be removed individually and can only be erased by removing all images.

7 CYCLONE PROGRAMMER MANUAL CONTROL

The **Cyclone LC** must be configured before it can serve as a Stand-Alone Programmer. The user may manually control the Cyclone via the LCD touchscreen menu and/or the Start button, or via PC software. See **CHAPTER 8 - CYCLONE PROGRAMMER AUTOMATED CONTROL (CYCLONE CONTROL SUITE)** for information on how to use the Cyclone Control Suite to configure, control, and automate Cyclone operations. The target power management schemes remain the same for each control method.

7.1 Operation Via Start Button

There is a Start button on the top of the Cyclone which is used for stand-alone programming. It is specified as follows.

<u>Button</u>	<u>Function</u>
START	Start executing the tasks pre-configured into the Cyclone of the currently selected programming image.

7.1.1 LED Indicators

The Cyclone has two (2) LEDs to indicate the current operation stage.

<u>LED</u>	<u>FUNCTION</u>
Error	The Cyclone failed to execute the functions as instructed.
Success	The Cyclone executed the functions successfully.

7.1.2 Procedure via Start Button / LEDs

The following steps must be followed in order for the Cyclone to operate properly after it has been configured:

1. Turn off the target power supply if the "POWER IN" Jack is adopted.
2. Turn off the Cyclone system power.
3. Set the correct Power Management jumper settings.
4. Connect the target power supply to the "POWER IN" Jack, if applicable.
5. Connect the "POWER OUT" Jack to the target board power, if applicable.
6. Connect the ribbon cable to the target board debug connector.
7. Turn on the Cyclone system power.
8. Turn on the target power supply, if applicable.
9. Press the "START" button on the Cyclone.

When the "Success" LED lights up, you have successfully programmed your target.

7.1.3 Example

After the user programs the contents and procedures into the Cyclone's on-board flash, the Cyclone may be used as a Stand-Alone Programmer. Suppose the user wants to perform the following instructions for a target device:

- 1) Erase Module
- 2) Program Module
- 3) Verify Module.

If the Cyclone is providing power to the target board, the "Target Power" icon will illuminate on the LCD display.

The Cyclone will then perform the operations. If they are performed successfully, the "Success" LED will be illuminated. One stand-alone programming cycle will have just been completed.

7.2 Operation Via LCD Touchscreen Menu

Once the **Cyclone LC** is configured for stand-alone programming it may be operated by making selections from the touchscreen LCD menu. This section describes the menu functions that allow the user to easily execute stand-alone programming functions using the touchscreen LCD.



















7.3 Home Screen

The home screen appears when the Cyclone is powered on, or when the  Home button is tapped.

7.3.1 Icons

A row of icons in the upper right corner indicates the status of various attributes of the Cyclone.

Note: The user may tap on the row of icons to view the meaning of each of the currently displayed icons.

Cyclone Unit Status: Ok / Bad				
Programming Status: Ready / Busy				
Target Power Relays: On / Off				
USB-To-PC Enumerated: Yes / No				
Real-Time clock Enabled & Working: Yes / No				
Cyclone Power Relays: Closed / Open				
Target Device Is Powered*: Yes / No				
SDHC Memory Card: None / Valid / Unformatted / Reset Cyclone**				

* Target Device Is Powered - “Yes” indicates that the **Cyclone LC** detects power on the Vcc pin of the target device programming header.

** SDHC Memory Card (Requires SDHC License Activation) - “Reset Cyclone” indicates that the Cyclone needs to be reset before the SDHC card will register as Valid. The user can push the Reset button which is located on the front side of the Cyclone, below the LED indicators.

7.3.2 Configurable Display Area

The main area of the home screen can be configured to optionally display the following information, by using the Cyclone IP Configuration Utility (see **Section 5.2.3.5.4 - Configure Home Screen**):

1. Firmware version of the Cyclone (always shown).
2. IP address assigned to the Cyclone.
3. Name assigned to the Cyclone.
4. Number of programming images in the Cyclone's memory.
5. Name of the selected programming image.
6. First serial number associated with the selected image
7. Current status.
8. Results of the last operation performed.
9. Time and date.
10. Status Window and Main Menu button (always shown).
11. Programming count & limit

7.4 Status Window

The status window appears in the lower left corner of the home screen and displays the results of programming operations.

7.4.1 Error Information Icon

When the Cyclone experiences an error during programming operations, the Info icon will appear to the left of the Menu button (or AUX button, if configured).

Info Icon:

Press the Info icon to view a detailed description of the error.

7.4.2 AUX Button (Appears If Configured)

The Cyclone allows the user to add an Auxiliary (AUX) button to the home screen which will perform a specific function when pressed. The specific function is chosen by the user when the AUX button is configured. The AUX button will appear on the home screen to the left of the “Menu” button, in the lower right corner of the home screen.

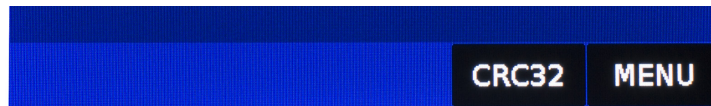

Figure 7-1: AUX Button On Home Screen (configured for perform CRC32 function)

For information on how to configure the AUX button, see **Section 5.2.4 - Status**.

7.4.3 Main Menu

The Main Menu is accessible by pressing the “Menu” button when the Home Screen is displayed. The Main Menu screen contains four selections. From these, select “Current Image Options.”

Current Image Options	Execute Image Function	Launch Programming	-
		Verify Data In Target	-
		Toggle Power	-
		Power cycle device to run user code	-
	Set Image Validation	Validate Image CRC32	-
		Enable Validate IMG	-
		Disable Validate IMG	-
	Serial Numbers	UID	-
		Next Serial # ASCII	-
		Algorithm ID	-
		CS ID	-
	Show Image Restriction Stats <i>(FX or ProCrypton License Only)</i>	Modify Serial	-
		-	-

Figure 7-2: Touchscreen LCD Menu - Standalone Functions Highlighted

The menu selections in “Current Image Options” will allow the user to execute programming operations, verify data, toggle power, validate the programming image, and modify the upcoming serial number if necessary.

7.4.3.1 Execute Image Function

Execute Specific SAP Function presents four Stand-Alone Programming functions that you may execute by tapping the function that you wish to execute:

7.4.3.1.1 Launch Programming

This allows the user to execute the programming function. The Cyclone will program the target device, if able, using the currently selected programming image. This is functionally equivalent to pressing the Start button.

7.4.3.1.2 Verify Data In Target

Performs a verify function on the data that has been programmed into the target device.

7.4.3.1.3 Toggle Power

Toggles the target power and makes sure all ports are driven to debug mode level.

7.4.3.1.4 Power Cycle Device To Run User Code

Toggles the target power and maintains tri-state mode for all signals.

7.4.3.1.5 Validate Image CRC32

Allows the user to perform a CRC32 validation on the currently selected programming image.

7.4.3.2 Set Image Validation

Allows the user to choose between two validation settings: 1) validate the image each time the Start button is pressed, or 2) do not validate the image.

7.4.3.3 Serial Numbers

Displays the serial number information associated with the currently selected programming image. If there is none, it will display, "This Image Contains No Serial Numbers." There may be one or more Serial Files associated with the image. The user can click on a specific Serial File name to see the following information about that Serial File:

- UID - Unique identifier of the serial number
- Next Serial # ASCII - Next serial number to be programmed (shown in ASCII format)
- Algorithm ID - Displays the algorithm ID of the serial file
- CS ID - Displays the ID of the CS (Choose Serial) command in the SAP file.

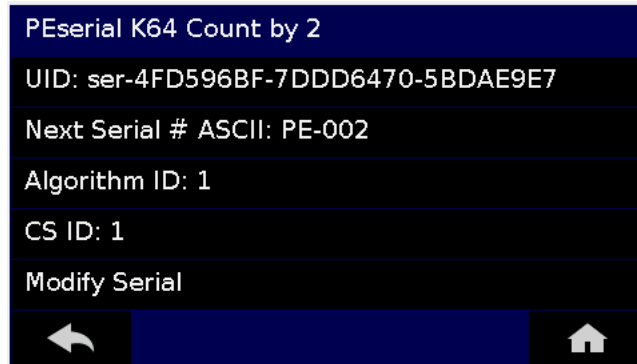

Figure 7-3: Serial File Selection

The user can also click on "Modify Serial Number" to edit that serial number. It is possible to Decrease or Increase the Next Serial by -10, -1, +1, +10. This is often done to address issues in the production process, such as during initial setup.

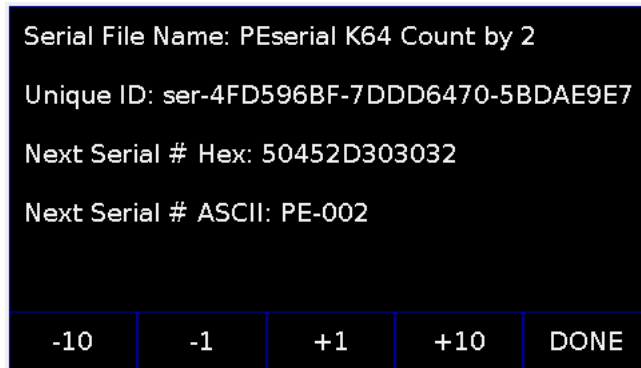

Figure 7-4: Increase or Decrease Serial Number

The adjustment buttons will display “Increase Not Allowed” and “Decrease Not Allowed” if the image/algorithm/CS file that the user has selected does not allow for this operation.

Note: Unlike PEmicro’s current serial files, earlier “legacy” serial files are specific to one programming image, When viewing Serial Number info for an image that references one or more legacy serial files, the Cyclone will not show links to the serial files but will instead display serial number info for the first serial file. The user can then Modify Next Serial to change the next serial number, or click MORE at the bottom to proceed to the next serial file (if any).

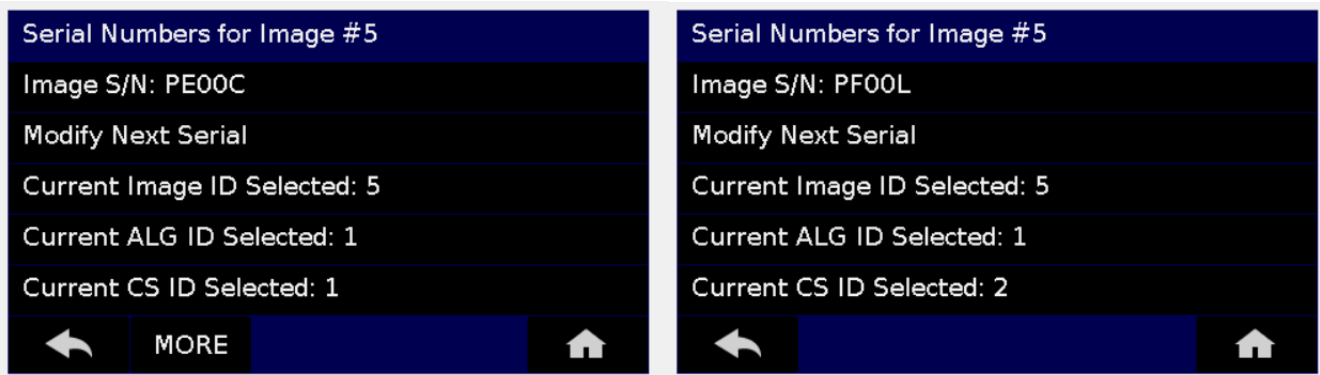

Figure 7-5: Serial Number View With Legacy Serial Files (CS IDs #1 & #2)

7.4.3.4 Show Image Restriction Stats (Requires FX or ProCryption Security License Activation)

Displays current statistics, if any, for Image Programmed Count & Maximum Allowed, Errors Logged & Maximum Allowed, and Date Range Allowed. These limits can be set in the Security Features section of the Cyclone Image Creation Utility (see **Section 6.1.8.2 - Image Restrictions**).

Note: When *Current Image Stats* is displayed as a home screen item, only Image Programmed Count & Maximum Allowed are displayed on the home screen.

8 CYCLONE PROGRAMMER AUTOMATED CONTROL (CYCLONE CONTROL SUITE)

Users who wish to control, configure, and automate one or more Cyclone units have several options available. This chapter presents a brief overview of those options along with some additional information about each.

8.1 Overview Of Cyclone Control Suite

The Cyclone Control Suite is a new generation of automated control software developed to support PC based control of the popular Cyclone and Cyclone FX stand-alone programmers.

The suite provides comprehensive control of one or more Cyclones from the PC via the following components: the Cyclone Control GUI application, the Cyclone Control Console application, or via custom applications using the Cyclone Control SDK. Ways to control the Cyclone include programming launch, recovering results, managing images resident on a Cyclone, adding unique programming data for each target, as well as recovering descriptive errors.

Much of the cyclone control feature set works for all touchscreen Cyclones. Advanced features require a Cyclone-resident Advanced Automation License which comes built into the Cyclone FX and is available as an upgrade for all other touch screen Cyclones.

8.1.1 Components

The Cyclone Control Suite consists of three major components:

1. Cyclone Control SDK – This is a Software Development Kit with a comprehensive API allowing multiple Cyclones to be managed simultaneously from a user developed custom application that loads the provided Cyclone Control DLL. The DLL can be loaded from many programming languages that are able to load a DLL (C, Delphi, C#, Java, Python, etc) as well as environments such as LabVIEW. Examples and interface code are provided in C (MSVC and GCC), C#, and Delphi/FPC. See **Section 8.2 - Cyclone Control SDK**.
2. Cyclone Control Console – This is a powerful command-line application can be launched from a script, a command-line, or another application and allows control of one or more Cyclones simultaneously. The command-line application displays comprehensive status messages and also returns an error code which can be recovered from the calling application. See **Section 8.3 - Cyclone Control Console**.
3. Cyclone Control GUI – This is an interactive GUI based application which provides an easy way to control Cyclones and manage images resident in the Cyclones. Given its graphical nature, it is very easy to explore Cyclone Control Suite capabilities to intuitively control or interact with a Cyclone. See **Section 8.4 - Cyclone Control GUI**.

The Console and GUI were both built with the SDK and are good examples of the types of applications which can be built using the SDK.

Additional sample applications come as part of the installation. They contain defined build scripts that you should be able to use to build the sample application without any modifications.

8.1.2 Features

The SDK, Console, and GUI control applications provide the following Standard features for all Cyclones:

- Control a Cyclone via USB, Serial, or Ethernet connections
- Select and Launch Images by Name or Enumeration
- Recover programming result and descriptive error information
- Use automatically counting local (Cyclone stored) serial numbers
- Add/Remove/Update a single image in the Cyclone
- Read/write Cyclone properties

- Read Image and target Properties and Status

The GUI application provides the following Advanced features for all Cyclones:

- Add/Remove/Update many images in the Cyclone
- Remote Display Access and the ability to “touch” the screen

These features require an Advanced license only when using the SDK or Console (see below).

The SDK and Console application provide the following Advanced features for all Cyclone FX units and any Cyclone upgraded with a resident Cyclone Control Advanced Automation License:

- Add/Remove/Update many images in the Cyclone
- Simultaneously (Gang) Control multiple Cyclones via the USB, Serial, or Ethernet connections
- Program (and Read) Dynamic Data in addition to fixed image data
- Remote Display Access

8.1.3 PEmicro Compatible Hardware

The following lists the PEmicro hardware that is compatible with the Cyclone Control Suite. To ensure proper operations, PEmicro recommends upgrading all Cyclone units to the latest firmware.

- Cyclone FX Universa
- Cyclone LC Universal
- Cyclone FX ARM
- Cyclone LC ARM
- Cyclone PRO (Standard features only)
- Cyclone MAX (Standard features only)
- Cyclone for ARM (Standard features only)
- Cyclone for Renesas (Standard features only)
- Cyclone for STMicro (Standard features only)

8.2 Cyclone Control SDK

The Cyclone Control SDK allows the user to interact with the Cyclone via a .DLL.

8.2.1 Introduction

The Cyclone Control SDK is one of the three components that comprise the Cyclone Control Suite. Its dynamic link library (.DLL) allows you to create an application on the PC that can directly control one or more PEmicro Cyclone units. These interface routines are designed to be compiled into visual and non visual applications running on Windows operating systems

The actual interface routines are located in the “CycloneControlSDK.dll” 32 bit DLL file. The DLL is callable from almost any 32-bit / 64-bit Windows development environment. Since the way the DLL is called varies depending on the compiler used, you are provided with the DLL interface code and sample applications for each of the following compilers. Compilers in bold link to a PEmicro blog post about using that environment with the SDK:

Borland Delphi 2.0+ (Pascal)

GCC

Microsoft Visual C

Microsoft Visual C#

NI LabVIEW 2018

The sample applications come with build scripts defined for ease of use. Simply run the scripts and you should be able to build the sample application without any modifications. The callable interface routines are defined in:

```
INSTALLDIR\cycloneControl\controlsdk\examples\pascal\cyclone_control_api.pas
INSTALLDIR\cycloneControl\controlsdk\examples\c\cyclone_control_api.h
```

8.2.2 Backwards Compatibility With Classic Cyclone Control API

The “CycloneControlSDK.dll” is backwards compatible with many of the classic Cyclone Control API calls. In each header file, there is a constant variable or define (typically DLL_filename) which is declared as the file name of the DLL. The value of this variable should be changed to new filename “CycloneControlSDK.dll” instead of the old “CYCLONE_CONTROL.dll”. After this modification, rebuild the project and it should continue working with the new DLL.

8.2.3 Getting Started with the Cyclone Control DLL

This section outlines the steps you need to take to begin developing your own custom application and offers tips and suggestions to get the Cyclone Control DLL working with your PEmicro hardware smoothly.

BLOG TIP: Please click [here](#) to visit the PEmicro blog for a detailed example of how to set up a programming image and use the SDK with some advanced options.

8.2.3.1 Example Programs

Located in the installation directory of the package, you will find two example programs that you can use as a reference for your own application. The examples are located in the following directories:

```
INSTALLDIR\cycloneControl\controlsdk\examples\pascal\
INSTALLDIR\cycloneControl\controlsdk\examples\c\
INSTALLDIR\cycloneControl\controlsdk\examples\labview2018
INSTALLDIR\cycloneControl\controlsdk\examples\msvc
INSTALLDIR\cycloneControl\controlsdk\examples\msvcsharp
```

These example programs are a valuable reference to use when starting your own custom application.

8.2.3.2 Starting your own project

To gain access to the functions available in the DLL, the following files need to be added to the new project workspace:

Delphi 2.0+ Projects

```
INSTALLDIR\cycloneControl\controlsdk\examples\pascal\cyclone_control_api.pas
```

All other source files which will call functions from the DLL should include the above file using the Delphi “uses” command.

MSVC 5.0+ Projects

```
INSTALLDIR\cycloneControl\controlsdk\examples\c\cyclone_control_api.h
INSTALLDIR\cycloneControl\controlsdk\examples\c\cyclone_control_api.c
```

All other source files which will call functions from the DLL should include the above header file with the C/C++ #include directive.

Msvc# 2017 Projects

```
INSTALLDIR\cycloneControl\controlsdk\examples\msvcsharp\visual_sap_control\cyclone_control_api.cs
```

NI LabVIEW 2018 Projects

```
INSTALLDIR\cyclone\cycloneControl\controlsdk\examples\labview2018\user.lib\CycloneControlSDK\CycloneControlSDK.lvlib
```

```
INSTALLDIR\cyclone\cycloneControl\controlsdk\examples\labview2018\user.lib\CycloneControlSDK\Vis\*.vi
```

The pre-built VIs that we provide include modifications for error handling using error clusters. Please visit our blog post “Automated Flash Programming with LabVIEW” for more information on how to develop your own LabVIEW project.

8.2.3.3 Initialization

Loading the DLL (C/C++ Projects only)

Before calling any routines from the DLL, the DLL must be loaded into memory. To do this, the following function has been provided in the included header files. Refer to Chapter 4 of this manual for a detailed description of this function.

```
loadLibrary( );
```

For Delphi (Pascal) and C# users, this process is transparent for the user and no action is required.

Enumerate all ports

After loading the DLL, a call to the following function is required in order to properly initialize all devices. This function should only be called once, typically at the beginning of the application.

```
enumerateAllPorts( );
```

Connect to the PEmicro hardware interface

The next step is to establish communications with the PEmicro Cyclone unit. This is accomplished with the following function call:

```
connectToCyclone( );
```

Refer to Chapter 4 of this manual for a detailed description of this function. This call returns the handle to the Cyclone unit which is used in all other routines in the DLL to identify the Cyclone. Note that the special case of a return value of 0 indicates an error contacting the Cyclone. This

function will be called once for each Cyclone.

8.2.3.4 Finalization

Before closing the application, it is recommended that the session with the PEmicro hardware be terminated and the DLL unloaded from memory.

These calls should always be made before the application closes:

```
disconnectFromAllCyclones( );
unloadLibrary();
```

Note that the “unloadLibrary” call is only required for C/C++ applications. For the Delphi and C# example projects, the DLL is automatically unloaded when the application closes.

8.2.3.5 Initial Cyclone Setup

The Cyclone Image Creation Utility software, which is included with each Cyclone, is used to create the standalone images that will be stored in the non-volatile memory of the Cyclone. These images contain the FLASH / EEPROM programming algorithms, the actual binary data to be programmed, the sequence of programming operations, and user specified Cyclone settings.

Prior to using the Cyclone Control Suite, these standalone images need to be created. Please refer to the user’s manual of your Cyclone unit for more information on standalone images and image creation.

8.2.3.6 Typical Usage

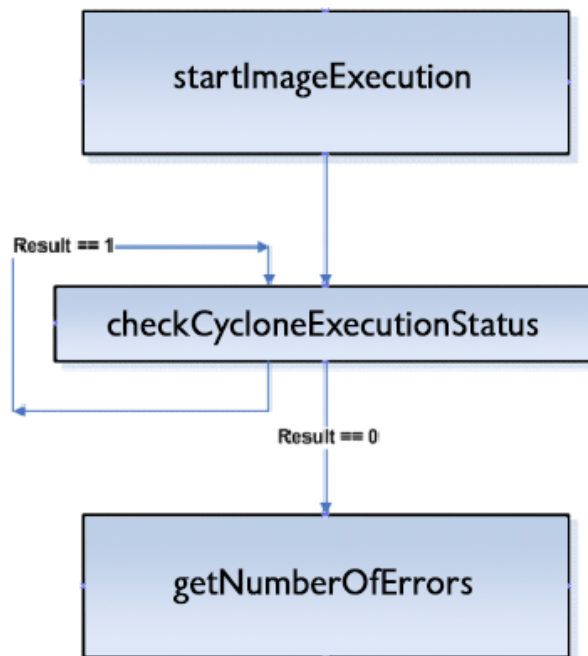

Figure 8-1: Typical programming procedure flow chart

Figure 8-1 describes the most common sequence of calls to the DLL after successfully connecting to the Cyclone unit.

- a. Initiate programming operations. “startImageExecution” carries out the programming operations defined in the stand-alone image stored on the Cyclone unit.
- b. Wait for programming completion. Note that no error checking is provided by the

“checkCycloneExecutionStatus” call. A result of 0 will be returned even if an error has occurred or if communication with the Cyclone is lost.

- c. Retrieve the error code from the Cyclone unit to determine if the programming was successful.

8.2.3.7 External Memory Storage Support

Some Cyclones support external memory storage. The Cyclone Control SDK and Cyclone Control Console both support images residing on external memory cards. The parameter “selectedMediaType” is used to select between Cyclone internal Flash and external memory.

Image numbers will go in ascending order starting with image number 1. Internal images will be counted first and external image numbers will start after the last internal image number. Image number 1 will refer to the first image in the internal memory if there are any images in the Cyclone internal memory, if there are no internal images, image 1 will refer to the first image in the external memory.

Modifying images residing in external memory will only be available on Cyclones with the proper license. Certain Cyclones may require a supplementary license to support external memory.

8.2.4 Application Programming Interface (API)

This chapter describes the API of the “CycloneControlSDK.dll” in detail. A C/C++ function prototype is given here. Header files are provided for the following languages:

Pascal

C/C++

8.2.4.1 Constants

Name	32-bit Value
CyclonePortType_USB	5
CyclonePortType_Ethernet	6
CyclonePortType_Serial	7
CycloneInformation_IP_Address	1
CycloneInformation_Name	2
CycloneInformation_Generic_Port_Number	3
CycloneInformation_Cyclone_Type_String	4
MEDIA_INTERNAL	1
MEDIA_EXTERNAL	2

8.2.4.2 DLL Loading / Unloading Calls

8.2.4.2.1 loadLibrary

*bool loadLibrary(char *filepath);*

This function loads the CycloneControlSDK.dll into memory and gives the user access to all of the

functions available in the library. **This routine must be called before any of the other routines can be called.**

@returnvalue	True if the load was successful, false otherwise.
--------------	---

8.2.4.2.2 unloadLibrary

void unloadLibrary(void);

This function unloads the DLL loaded with loadLibrary(). This call should be made before the application starts to unload itself.

8.2.4.2.3 enumerateAllPorts

void enumerateAllPorts(void);

This function performs all necessary initialization in order to successfully communicate with a Cyclone. The function is called once before the first call to “connectToCyclone”.

8.2.4.2.4 disconnectFromAllCyclones

void disconnectFromAllCyclones(void);

This function closes all open Cyclones (if any) and frees all dynamic memory used by the DLL. The function is called before the user application is closed.

8.2.4.2.5 version

*char *version(void);*

This call returns a pointer to a null-terminated string that contains the version number of the DLL.

@returnvalue	A pointer to a null-terminated string containing the version number of the DLL.
--------------	---

8.2.4.2.6 queryNumberOfAutodetectedCyclones

*uint32_t *queryNumberOfAutodetectedCyclones(void);*

This function returns the number of Cyclones connected locally on USB and on your local network.

@returnvalue	The number of Cyclones.
--------------	-------------------------

8.2.4.2.7 queryInformationOfAutodetectedCyclone

*char *queryInformationOfAutodetectedCyclone(int32_t autodetectIndex, int32_t informationType);*

@parameter autodetectIndex	Specifies the index of the detected Cyclone by the function queryNumberOfAutodetectedCyclones()
-------------------------------	---

@parameter informationType	Specifies the property of the Cyclone to return. The possible values are: <ul style="list-style-type: none"> • CycloneInformation_IP_Address • CycloneInformation_Name • CycloneInformation_Generic_port_number
@returnvalue	A pointer to a null-terminated string containing the property value of the specified Cyclone.

8.2.4.3 Cyclone Connecting / Disconnecting Calls

8.2.4.3.1 connectToCyclone

```
uint32_t connectToCyclone(char *nameIpOrPortIdentifier) ;
```

This function opens a session with a Cyclone and tests the connection. The handle returned by this function is passed as a parameter to other functions provided by the DLL. If you connect to a Cyclone that already has a handle, the same handle is returned. If there is a failure contacting the Cyclone, the function returns a 0.

Note that the DLL does not support multiple Cyclones connected via the serial port. If you require more than one Cyclone to use a serial port connection, PEmicro recommends using the RS232 communication protocols.

@parameter nameIPOrPortIdentifier	<p>A pointer to a null-terminated string which uniquely identifies the Cyclone connected to the host PC.</p> <p>If identifying by IP address, the string should be in the format of xxx.xxx.xxx.xxx, where xxx = 0...255.</p> <p>If identifying by name, the string should contain the name of the Cyclone.</p> <p>If identifying by port and the Cyclone is connected by USB, the string should be USB# where # is 1...8. If the Cyclone is connected by Ethernet, the string should be in the format of xxx.xxx.xxx.xxx, where xxx = 0...255.</p> <p>If the Cyclone is connected by Serial, the string should be COM1.</p>
@returnvalue	The handle to the opened Cyclone unit. A return value of 0 indicates a failure to connect to the specified Cyclone unit.

8.2.4.3.2 connectToMultipleCyclones

```
bool connectToMultipleCyclones(char *nameIpOrPortIdentifierArray,  
multipleCycloneHandleArrayPtrType cycloneHandleArrayPointer, int32_t  
*numberOfCycloneOpensAttempted);
```

This function returns a array of handles to opened Cyclones from a null-terminated String of comma delimited identifiers.

<p>@parameter nameIpOrPortIdentifierArray</p>	<p>A null terminated string containing one or more Cyclone identifiers (name, IP address, or port number) delimited by commas.</p> <p>Example: USB1,209.1.10.2,Orion,COM1</p> <p>If identifying by IP address, the string should be in the format of xxx.xxx.xxx.xxx, where xxx = 0...255.</p> <p>If identifying by port and the Cyclone is connected by USB, the string should be USB# where # is 1...8.</p> <p>If the Cyclone is connected by Serial, the string should be COM1.</p>
<p>@parameter multipleCycloneHandleArrayPtrType</p>	<p>A pointer to an array of Cyclone handles. Each element of the array corresponds to the position of the identifier in the previous parameter. If the function connected to the Cyclone, the value of the array element would correspond to its handle otherwise it will be 0.</p>
<p>@parameter numberOfCycloneOpensAttempted</p>	<p>This value will be modified with the number of Cyclones that the function attempted to open. It is also the size of the multipleCycloneHandleArrayPtrType structure.</p>
<p>@returnvalue</p>	<p>True if every Cyclone was identified and has a valid handle.</p> <p>False if there were any errors identifying or connecting to any of the Cyclones.</p>

8.2.4.3.3 setLocalMachineIpNumber

```
void setLocalMachineIpNumber(char* ipNumber);
```

If a PC has multiple network interface cards, this function sets the IP address of the network card to use communicate with the Cyclones. This is called prior to calling any other functions.

<p>@parameter ipNumber</p>	<p>A pointer to a null-terminated character string in the format xxx.xxx.xxx.xxx, where xxx = 0...255, representing the IP address of the network card.</p>
----------------------------	---

8.2.4.4 Controlling Cyclone Programming

8.2.4.4.1 startImageExecution

```
bool startImageExecution(uint32_t cycloneHandle, uint32_t imageId);
```

A Cyclone may have several independent programming images in its non-volatile internal or external memory. A programming image contains the programming algorithms, binary data, and programming sequence. This function instructs the Cyclone to start execution of an image. After invoking this call, the “checkCycloneExecutionStatus” function is used to poll the Cyclone until completion.

@parameter cycloneHandle	The handle of the Cyclone to begin programming operations
@parameter imageId	Selects the image on the Cyclone to use. The valid range of this parameter is from 1 to the total number of images in the Cyclone with the count starting from internal memory and then external memory. If a Cyclone only stores one image, this parameter is 1.
@returnvalue	True if the programming process has started successfully. False otherwise.

8.2.4.4.2 startDynamicDataProgram

```
bool startDynamicDataProgram(uint32_t cycloneHandle, uint32_t targetAddress,
uint16_t dataLength, char *buffer);
```

Sometimes, in addition to the large amount of static data being programmed into a target from the Cyclone, it is advantageous for the calling application to program small sections of unique data dynamically. Examples of this include date/time, serial number, MAC addresses, and lot numbers.

This function is valid to be called only after a programming image has been programmed into the target (once startImageExecution has completed). Call the “checkCycloneExecutionStatus” function to wait for completion. If the target is reset by the Cyclone or by a power cycle after programming the image, this function will fail. The workaround for this is to execute a second image that will re-load the algorithm before you call startDynamicDataProgram.

@parameter cycloneHandle	The handle of the Cyclone to begin dynamic programming.
@parameter targetAddress	The first memory address of the target processor where the dynamic data should be written.
@parameter dataLength	The total number of bytes to be written. This parameter cannot be greater than 255.
@parameter buffer	A pointer to the array which holds the data to be written.
@returnvalue	True if the programming process has started successfully. False otherwise.

8.2.4.4.3 checkCycloneExecutionStatus

```
uint32_t checkCycloneExecutionStatus(uint32_t cycloneHandle);
```

Checks to see if the Cyclone has completed a programming operation started with either the “startImageExecution” or “startDynamicDataProgram” functions.

After this function returns with completed value, “getLastErrorCode” should be called to determine the programming result. A result of 0 will be returned even if a programming error has occurred or if communication with the Cyclone is lost.

@parameter cycloneHandle	The handle of the Cyclone to perform a status check on.
@returnvalue	1 = Currently programming 0 = Completed (with or without error)

8.2.4.4.4 dynamicReadBytes

```
bool dynamicReadBytes(uint32_t cycloneHandle, uint32_t targetAddress, uint16_t dataLength, char *buffer);
```

This function reads a specified number of bytes from a specified memory address of the target processor. This call is only valid after first having made a call to the “startImageExecution” function in the sequence of commands.

@parameter cycloneHandle	The handle of the Cyclone that will perform the dynamic read.
@parameter targetAddress	The first memory address of the target processor where the data will be read.
@parameter dataLength	The number of total bytes to read from the target processor
@parameter buffer	A pointer to the array where the data read will be stored. This array must have been allocated prior to calling this function.
@returnvalue	True if the data was successfully read False otherwise

8.2.4.4.5 getNumberOfErrors

```
uint32_t getNumberOfErrors(uint32_t cycloneHandle);
```

This function returns a count of all the errors recorded in the DLL and in the Cyclone.

@parameter cycloneHandle	The handle of the Cyclone to get a count of the errors.
@returnvalue	The number of errors in the DLL and in the Cyclone.

8.2.4.4.6 getErrorCode

```
uint32_t getErrorCode(uint32_t cycloneHandle, uint32_t errorNum);
```

This function returns the specified error code recorded in the DLL or in the Cyclone.

@parameter cycloneHandle	The handle of the Cyclone to retrieve the error code.
@parameter errorNum	If getNumberOfErrors is greater than 1, this specifies the error number.

@returnvalue	The error code of the DLL or Cyclone
--------------	--------------------------------------

8.2.4.4.7 getLastErrorAddr

```
uint32_t getLastErrorAddr(uint32_t cycloneHandle);
```

If the “getErrorCode” function returns a non-zero value (indicating an error has occurred), this routine can be used to query the address where the error occurred.

@parameter cycloneHandle	The handle of the Cyclone from which to request the error address.
@returnvalue	The memory address where the last programming error occurred.

8.2.4.4.8 getDescriptionOfErrorCode

```
char *getDescriptionOfErrorCode(uint32_t cycloneHandle, uint16_t errorCode);
```

This function returns a description of the error code.

@parameter cycloneHandle	The handle of the Cyclone to retrieve the error code description.
@parameter errorCode	The error code to check.
@returnvalue	A pointer to a null-terminated character string that contains the error code description.

8.2.4.4.9 resetCyclone

```
bool resetCyclone(uint32_t cycloneHandle, uint32_t resetDelayInMs);
```

This function performs a hard reset of the Cyclone. It is the same as pressing the reset button. This is considered a legacy call and does not need to be called by the application.

@parameter cycloneHandle	The handle of the Cyclone that will be reset.
@parameter resetDelayInMs	The reset delay, specified in milliseconds. The delay should be at least 5500 ms.
@returnvalue	True if reset was successful False otherwise

8.2.4.5 Configuration / Image Maintenance Calls

8.2.4.5.1 getImageDescription

```
char *getImageDescription(uint32_t cycloneHandle, uint32_t imageId) ;
```

This function returns the description of a particular image stored on the Cyclone (internal Flash or external memory card). This description is specified by the user when the image is created.

@parameter cycloneHandle	The handle of the Cyclone to get an image description.
--------------------------	--

@parameter imageId	Used to select which image stored on the Cyclone to read the description from. The valid range of this parameter is from 1 to the total number of images in the Cyclone with the count starting from internal memory and then external memory. If a Cyclone only stores one image, this parameter should be set to 1.
@returnvalue	A pointer to a null-terminated character string which contains the image description

8.2.4.5.2 compareImageInCycloneWithFile

```
bool compareImageInCycloneWithFile(uint32_t cycloneHandle, char *aFile, uint32_t imageId);
```

This function compares an image stored on the Cyclone against a .SAP file created with the Cyclone Image Creation Utility.

@parameter cycloneHandle	The handle of the Cyclone that will have its image compared
@parameter aFile	A pointer to a null-terminated character string which contains the full path to the .SAP file that will be compared
@parameter imageId	Used to select which image stored on the Cyclone to compare against. The valid range of this parameter is from 1 to the total number of images in the Cyclone with the count starting from internal memory and then external memory. If a Cyclone only stores one image, this parameter should be set to 1.
@returnvalue	True if the image and the .SAP file match False otherwise Note that a false will also be returned if an error occurred during communications between the PC and the Cyclone unit.

8.2.4.5.3 formatCycloneMemorySpace

```
bool formatCycloneMemorySpace(uint32_t cycloneHandle, uint32_t selectedMediaType);
```

This function erases all images stored on the selected media type. This function should not be constantly called, as this will shorten the lifespan of the non-volatile flash memory. It is recommended that the user make use of the “compareImageInCycloneWithFile” function first to determine if an erase is indeed necessary. (e.g. if the images on the Cyclone do not match the

latest images on a server).

@parameter cycloneHandle	The handle of the Cyclone that will have its images erased
@parameter selectedMediaType	This parameter selects between Cyclone internal Flash (selectedMediaType = 1) or external memory (selectedMediaType =2).
@returnvalue	True if the erasure was successful False otherwise

8.2.4.5.4 eraseCycloneImage

bool eraseCycloneImage(uint32_t cycloneHandle, uint32_t imageId);

This function erase the specified image that is stored on the Cyclone. This function is not supported by legacy Cyclone. It is recommended that the user make use of the “compareImageInCycloneWithFile” function first to determine if an erase is indeed necessary. (e.g. if the images on the Cyclone do not match the latest images on a server).

@parameter cycloneHandle	The handle of the Cyclone that will have its image erased
@parameter imageId	Selects the image on the Cyclone to use. The valid range of this parameter is from 1 to the total number of images in the Cyclone with the count starting from internal memory and then external memory. If a Cyclone only stores one image, this parameter is 1.
@returnvalue	True if the erasure was successful False otherwise

8.2.4.5.5 addCycloneImage

*uint32_t addCycloneImage(uint32_t cycloneHandle, uint32_t selectedMediaType, bool replaceImageOfSameDescription, char *aFile);*

This function adds a specified stand-alone programming image into the selected media type. The image files have a .SAP file extension and are created with the Cyclone Image Creation Utility. If the Cyclone’s storage limits are reached, this routine will return an error.

@parameter cycloneHandle	The handle of the Cyclone that will accept the new image
@parameter selectedMediaType	This parameter selects between Cyclone internal Flash (selectedMediaType = 1) or external memory (selectedMediaType =2).

@parameter replaceImageOfSameDescription	Set to True if you want the image to overwrite any existing images with the same description Set to False if you do not want the image to overwrite any existing images with the same description. An error will occur.
@parameter aFile	A pointer to a null-terminated character string which contains the full path to the .SAP file to be added.
@returnvalue	The image number of the image that was just added. This number is used as the "imageld" parameter for some function calls. A return value of "0" indicates an error has occurred during the process.

8.2.4.5.6 countCycloneImages

```
uint32_t countCycloneImages(uint32_t cycloneHandle);
```

This function returns the number of stand-alone programming images currently stored in the internal Flash and the external memory card of the Cyclone.

@parameter cycloneHandle	The handle of the Cyclone to query for the image count
@returnvalue	The total number of images stored in internal and external memory.

8.2.4.5.7 getPropertyValue

```
char *getPropertyValue(uint32_t cycloneHandle, uint32_t resourceOrImageId, char *categoryName, char *propertyName);
```

This function reads a property value of the Cyclone or a stored SAP image. Examples of properties are Cyclone Name, Cyclone IP Address, Image Name or Image media type. There are different categories with different properties. Refer to the header file for a list of valid category and property names. The function getPropertyList will return a list of valid properties for each category.

@parameter cycloneHandle	The handle of the Cyclone from which to read the property.
@parameter resourceOrImageId	The id for image properties is the image id on the Cyclone. The id for Cyclone or Network properties is 0.
@parameter categoryName	A pointer to a null-terminated character string that contains the category of the property that will be read.
@parameter propertyName	A pointer to a null-terminated character string that contains the name of the property that will be read.
@returnvalue	A pointer to a null-terminated character string that contains the value of the property.

8.2.4.5.8 setPropertyValue

```
bool setPropertyValue(uint32_t cycloneHandle, uint32_t resourceOrImageId, char *
categoryName, char *propertyName, char *newValue);
```

This function changes the property of the Cyclone to the value specified. Only certain properties can be changed using this call. This function will return false if the property was not changed. Refer to the header file for a list of valid category and property names. The function getPropertyList will return a list of valid properties for each category.

@parameter cycloneHandle	The handle of the Cyclone from which to read the property.
@parameter resourceOrImageId	The id for image properties is the image id on the Cyclone. The id for Cyclone or Network properties is 0.
@parameter categoryName	A pointer to a null-terminated character string that contains the category of the property that will be modified.
@parameter propertyName	A pointer to a null-terminated character string that contains the name of the property that will be modified.
@parameter newValue	A pointer to a null-terminated character string that contains the new value of the property.
@returnvalue	True if the data was successfully set False otherwise

8.2.4.5.9 getPropertyList

```
char *getPropertyList(uint32_t cycloneHandle, uint32_t resourceOrImageId, char
*categoryName);
```

This function returns a list of valid category and property names that can be used with the “getPropertyValue” and “setPropertyValue” functions. Refer to the header file for a list of valid category and property names.

@parameter cycloneHandle	The handle of the Cyclone that will return the property list.
@parameter resourceOrImageId	The id for image properties is the image id on the Cyclone. The id for Cyclone or Network properties is 0.
@parameter categoryName	A pointer to a null-terminated character string that contains the category of the property list.
@returnvalue	A pointer to a null-terminated character string that contains a list of property names.

8.2.4.6 Features Calls

8.2.4.6.1 getFirmwareVersion

```
char *getFirmwareVersion(uint32_t cycloneHandle);
```

This function reads the firmware version of the selected Cyclone.

@parameter cycloneHandle	The handle of the Cyclone of which to read the firmware version.
@returnvalue	Returns a pointer to a null-terminated character string containing the firmware version.

8.2.4.6.2 cycloneSpecialFeatures

```
bool cycloneSpecialFeatures(uint32_t featureNum, bool setFeature, uint32_t paramValue1, uint32_t paramValue2, uint32_t paramValue3, void *paramReference1, void *paramReference2);
```

This function is used for executing special features described by the featureNum parameter. Refer to the parameter specifications below for details.

@parameter featureNum	CYCLONE_GET_IMAGE_DESCRIPTION_FROM_FILE
@parameter setFeature	Indicates whether the image file has been decoded. If previous operations has already decoded the file, then set it to true. Otherwise set it to false.
@parameter paramValue1	Ignored, set it to 0.
@parameter paramValue2	Ignored, set it to 0.
@parameter paramValue3	Ignored, set it to 0.
@parameter paramReference1	A pointer to a pointer to a null-terminated character string that contains the image description of the SAP file.
@parameter paramReference2	A pointer to a null-terminated character string which contains the full path to the specified SAP file.
@returnvalue	True if the image description was read False otherwise

@parameter featureNum	CYCLONE_GET_IMAGE_CRC32_FROM_FILE
@parameter setFeature	Indicates whether the image file has been decoded. If previous operations has already decoded the file, then set it to true. Otherwise set it to false.
@parameter paramValue1	Ignored, set it to 0.
@parameter paramValue2	Ignored, set it to 0.
@parameter paramValue3	Ignored, set it to 0.
@parameter paramReference1	A pointer to an unsigned 32-bit value containing the CRC32 of the SAP file.

@parameter paramReference2	A pointer to a null-terminated character string which contains the full path to the specified SAP file.
@returnvalue	True if the CRC32 was read False otherwise

@parameter featureNum	CYCLONE_GET_IMAGE_SETTINGS_FROM_FILE
@parameter setFeature	Indicates whether the image file has been decoded. If previous operations has already decoded the file, then set it to true. Otherwise set it to false.
@parameter paramValue1	The type of setting to extract {configuration script=1, image unique id etc.=2, serial numbers=3, additional settings=4, crc_exclusive settings=5}.
@parameter paramValue2	Ignored, set it to 0.
@parameter paramValue3	Ignored, set it to 0.
@parameter paramReference1	A pointer to a pointer to a null-terminated character string that contains the settings of the SAP file.
@parameter paramReference2	A pointer to a null-terminated character string which contains the full path to the specified SAP file.
@returnvalue	True if the image settings was read False otherwise

@parameter featureNum	CYCLONE_GET_IMAGE_COMMMAND_LINE_PARAMS_FROM_FILE
@parameter setFeature	Indicates whether the image file has been decoded. If previous operations has already decoded the file, then set it to true. Otherwise set it to false.
@parameter paramValue1	Ignored, set it to 0.
@parameter paramValue2	Ignored, set it to 0.
@parameter paramValue3	Ignored, set it to 0.
@parameter paramReference1	A pointer to a pointer to a null-terminated character string that contains the command line parameters of the SAP file.
@parameter paramReference2	A pointer to a null-terminated character string which contains the full path to the specified SAP file.
@returnvalue	True if the command line parameters was read False otherwise

@parameter featureNum	CYCLONE_GET_IMAGE_SCRIPT_FILE_FROM_FILE
@parameter setFeature	Indicates whether the image file has been decoded. If previous operations has already decoded the file, then set it to true. Otherwise set it to false.
@parameter paramValue1	Ignored, set it to 0.
@parameter paramValue2	Ignored, set it to 0.
@parameter paramValue3	Ignored, set it to 0.
@parameter paramReference1	A pointer to a null-terminated character string that contains the name of the script file.
@parameter paramReference2	A pointer to a null-terminated character string which contains the full path to the specified SAP file.
@returnvalue	True if the script file was read False otherwise

@parameter featureNum	CYCLONE_TOGGLE_POWER_NO_DEBUG
@parameter setFeature	Ignored, set it to false.
@parameter paramValue1	Ignored, set it to 0.
@parameter paramValue2	Ignored, set it to 0.
@parameter paramValue3	Ignored, set it to 0.
@parameter paramReference1	Ignored, set it to null.
@parameter paramReference2	Ignored, set it to null.
@returnvalue	True if the power was toggled. False otherwise

@parameter featureNum	CYCLONE_SET_ACTIVE_SECURITY_CODE
@parameter setFeature	Ignored, set it to true.
@parameter paramValue1	The security code type (e.g. MON08, Renesas, PPC Nexus 64 bit, PPC Nexus 256 bit ignored, set it to 0).
@parameter paramValue2	The length of the security code bytes.

@parameter paramValue3	Ignored, set it to 0.
@parameter paramReference1	A pointer to an array containing the security code bytes.
@parameter paramReference2	A pointer to a null-terminated character string containing the security type string (such as 'MON08', 'RENESAS', 'PPCNEXUS').
@returnvalue	True if the security code was set False otherwise

8.3 Cyclone Control Console

The Cyclone Control Console, the next component of the Cyclone Control Suite, is an application that controls Cyclone operations through the use of simple console commands. This application is very easy to set up and use and offers functionality very similar to using the Cyclone Control DLL directly.

To find the Cyclone Control Console application, navigate to the following directory:

[INSTALLDIR]\Cyclone Control\

The Cyclone Control software performs all operations specified in simple commands. A separate batch file would typically be used to launch the utility with the correct parameters.

BLOG TIP: Please click [here](#) to visit the PEmicro blog for detailed examples that show how to use the Cyclone Control Console to connect to the Cyclone, manage programming images, launch programming, and more.

8.3.1 Startup

- a. Connect all Cyclone units to the PC via RS232, USB, or Ethernet. Any combination of different connections is allowed. The exception is that only one RS232 serial port connection can be used; no more than one Cyclone can be connected via the RS232 serial port.
- b. Connect all Cyclones to their target systems. This is done using a ribbon cable that connects from the Cyclone to a debug header on the target board.
- c. Power up the PC, all Cyclone units, and all target systems that require external power.
- d. Run the CycloneControlConsole software from the DOS prompt.

8.3.2 Command-Line Parameters

The command-line utility supports the following commands:

-listcyclones

Shows a list of auto-detected Cyclones

-cyclone=[cyclone identifier]

Opens the Cyclone or Cyclones by name or identifier. The Cyclone argument can be a single identifier or a comma delimited list. Available identifiers are cyclone name, port number, or IP address.

-listimages

List the images present on all open Cyclones. If there are no open Cyclones the command will list the images on all detected Cyclones.

-launchimage=[image name or number]

Launch a specific image on the open Cyclones. The image can be identified by name or image number.

-putdynamicdata=[cyclone number],[address],[data]

ONLY SUPPORTED BY CYCLONE FX OR THE CYCLONE CONTROL SUITE ADVANCED LICENSE.
 Performs programming of dynamic data with the selected Cyclone unit. [cyclone number] is the index of the connected Cyclone in the order in which it was entered. [address] is the starting memory address. [data] are the bytes of data to be programmed. All values should be in hexadecimal format. No more than 255 bytes may be programmed this way.

A Cyclone unit may only use this command after it has performed its “-launchimage” command.

If the target is reset after programming the image, “-putdynamicdata” will fail. The workaround to this is to execute a second blank image that will re-load the algorithm before using this command.

-putdynamicstring=[cyclone number],[address],[string]

Performs programming of dynamic data with the selected Cyclone unit. [cyclone number] is the index of the connected Cyclone in the order in which it was entered. [address] is the starting memory address. [string] is the data in string format. No more than 255 bytes may be programmed this way.

A Cyclone unit may only use this command after it has performed its “-launchimage” command.

If the target is reset after programming the image, “-putdynamicstring” will fail. The workaround to this is to execute a second blank image that will re-load the algorithm before using this command.

-showproperties=[category],[image id if applicable]

List all available properties in a [category] in the open Cyclones or a stored SAP image by using the [image id if applicable] argument. Refer to the header file for a list of valid category and property names. Using an empty string as the [category] value will return the available categories.

-addimageinternal=[filename]

Add a specific programming image to the internal memory of the open Cyclones. [filename] is the path and filename of the image to be programmed into the Cyclones.

-addimageexternal=[filename]

ONLY SUPPORTED WITH CYCLONE FX OR THE CYCLONE MEMORY EXPANSION LICENSE.
 Add a specific programming image to the external memory of the open Cyclones. [filename] is the path and filename of the image to be programmed into the Cyclones.

-eraseallinternalimages

Perform a format of the internal memory connected to the open Cyclones. This will cause all internal images to be erased.

-eraseallexternalimages

Perform a format of the external memory connected to the open Cyclones. This will cause all external images to be erased.

-eraseimage=[image name or number]

Erase an individual image from the open Cyclones. The image can be identified by image name or by image number.

-listserialfiles

List Serial Files in Cyclone

-addserialfile=[file path]

Add Serial File to Cyclone

-deleteserialfile=[object ID or display index]

Delete Serial File from Cyclone. Can be deleted by ID or by display index.

-firmwareupdate=[firmware update mode]

Set the firmware update mode to “auto”, “dontupdate”, “forceupdate”. The default mode is “auto.”

-help

Display a list of available commands.

The following command-line parameters require a **Cyclone FX**, or a **Cyclone LC** with the ProCryption Security Activation License.

-listencryptionkeys

List Encryption Key Files that reside on Cyclone

-addencryptionkey=[file path]

Add ImageKey file to Cyclone. The file path is the path to the ImageKey.

-deleteencryptionkey=[object ID or display index]

Delete ImageKey File from Cyclone. Can be deleted by ID, or by display index number (-listencryptionkeys returns a numbered list of ImageKeys; the display index corresponds to these numbers).

8.3.3 Examples

The commands should be separated by a space. Every command starts with a “-” character, arguments follow the “=” character.

8.3.3.1 Typical Usage

```
CycloneControlConsole.exe -cyclone=10.0.1.1 -launchimage=1
```

This example connects to a single Cyclone identified by its IP address 10.0.1.1 and executes its first image. This is the most common usage of the Cyclone Control Utility.

```
CycloneControlConsole.exe -cyclone=USB1 -launchimage=1
```

This example connects to a single Cyclone enumerated on USB1 and executes its first image.

8.3.3.2 Controlling Multiple Cyclones

```
CycloneControlConsole.exe -cyclone=USB1,10.0.1.2,10.0.1.3 -
launchimage=2
```

This example connects to three separate Cyclone units. Two units are connected via USB (10.0.1.1 and 10.0.1.2) and the third is connected via Ethernet (10.0.1.3). The three Cyclone units are configured to execute image #2.

8.3.3.3 Programming Dynamic Data

```
CycloneControlConsole.exe -cyclone=CycloneFX_Table1,CycloneFX_Table2  
-launchimage=1 -putdynamicdata=2,1080,45,44,49,53,4F,4E
```

Here, a Cyclone is connected via the Serial port and is identified by name rather than IP address. After executing image #1 on both cyclones, we write 6 bytes of dynamic data on Cyclone #2 starting at address 0x1080. Note that all parameters for the “-putdynamicdata” command should be hexadecimal values.

8.3.3.4 Executing more than 1 image on the same Cyclone

```
CycloneControlConsole.exe -cyclone=CycloneFX_1,CycloneFX_2  
-launchimage=1 -launchimage=2
```

Two Cyclone units are connected via Ethernet and both Cyclone units execute their first image. Afterwards, the both Cyclones will execute their second image.

This example is useful when the processor’s code is split into two separate images. For example, one image could contain the bootloader while the second image contains the main application code.

8.3.3.5 Image Management – Modifying External Images

```
CycloneControlConsole.exe -cyclone=USB1 -eraseallexternalimages  
-addexternalimage=c:\images\externalImage1.SAP
```

In this example, a Cyclone unit is connected via USB and it has an image stored on its external memory card. The external image is erased and a new one is added. This type of command should only be used when an image needs to be updated.

8.3.3.6 Image Management – Modifying Images on Two Cyclones in Parallel

```
CycloneControlConsole.exe -cyclone=USB1,USB2 -eraseallinternalimages  
-addinternalimage=c:\images\Image1.SAP
```

In this example, two Cyclone units connected via USB have their images erased and a new image is added to both Cyclone units. This type of command should only be executed when images need to be updated.

8.4 Cyclone Control GUI

As part of the Cyclone Control Suite, PEmicro includes the Cyclone Control GUI, a graphical application that gives the users access to all the functions of the latest Cyclone Control.

Note: This new application replaces the previous Image Manager Utility and Cyclone Config IP Utility. The Cyclone Control GUI allows users to add and remove images from the internal Cyclone memory as well as from the external memory cards. The utility also allows the user to view and edit Cyclone properties, to view the Cyclone LCD remotely, to view and add Cyclone Licenses, and to

view and manage Serial Files and Encryption Keys.

The utility is composed of three main parts: a connection dialog, the control tabs, and a status window.

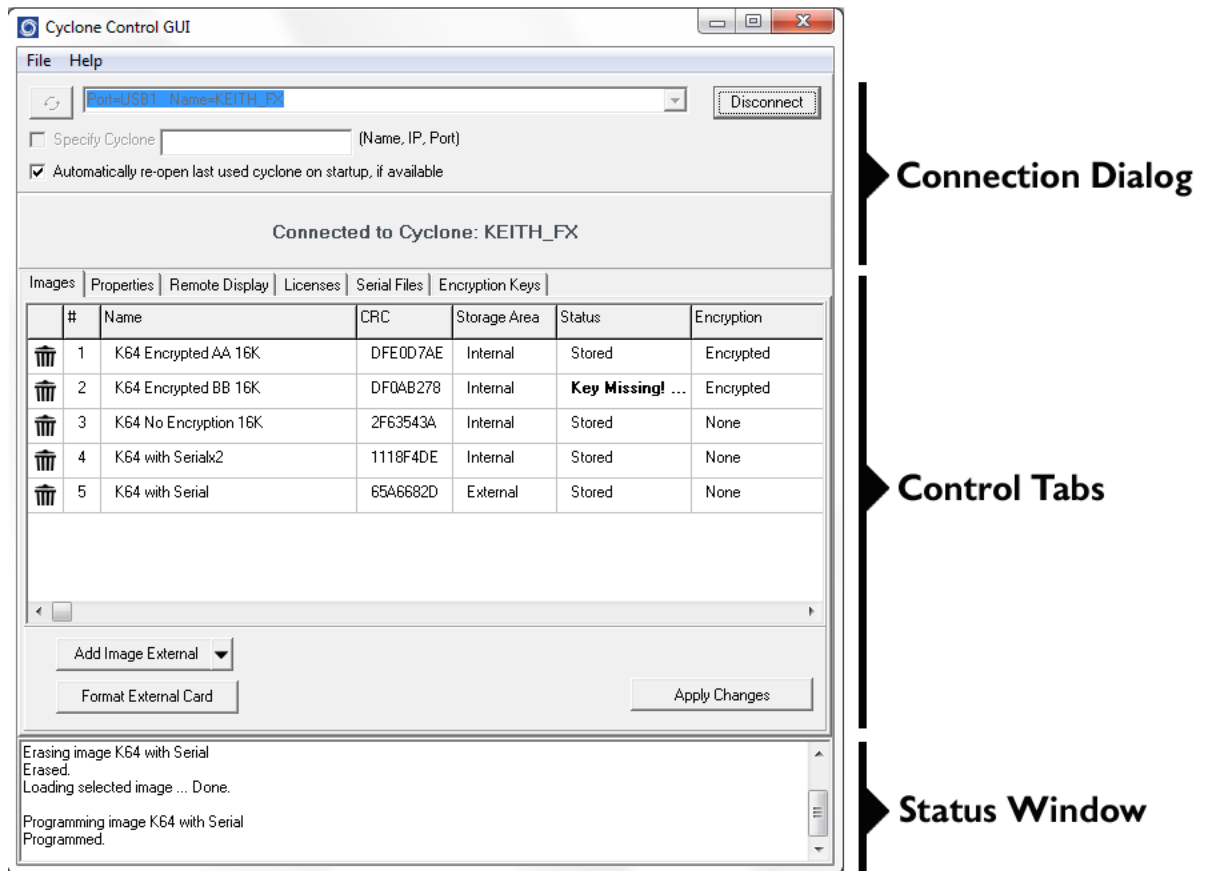

Figure 8-2: Areas of the Cyclone Control GUI

8.4.1 The Connection Dialog

Allows the user to specify a Cyclone to connect with, as well as specify the connection options. The utility will always automatically upgrade the firmware of a Cyclone if the firmware in the Cyclone is outdated. However, firmware update can also be forced by using the checkbox in File->Force Firmware Update. This option will update the firmware on the Cyclone with the latest firmware in the same folder as the Cyclone Control GUI.

At launch, the Cyclone Control GUI will show all the Cyclones detected on the network and those attached by USB connections in a drop-down list. Cyclones can also be connected to by using the “Specify Cyclone” checkbox and specifying a Cyclone by identifier. This identifier can be the Cyclone name, its IP address or its port number.

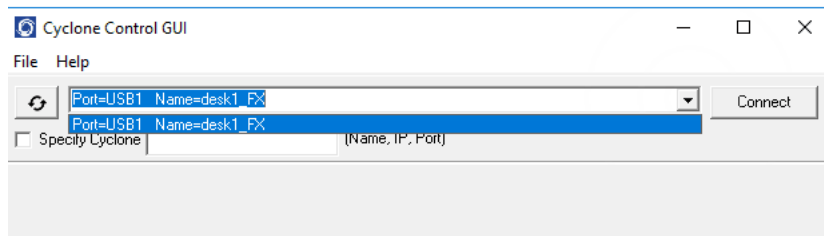

Figure 8-3: Select Cyclone From Drop Down

Once the Cyclone is selected, clicking on the “Connect” button will bring a series of tabs that will allow full access to the Cyclone.

8.4.2 The Control Tabs

The control tabs allow access to the Cyclone. Through these tabs you can view, add, and erase Cyclone images, you can view and modify properties, you can modify licenses, see the Cyclone screen remotely and view/manage Serial Files and Encryption Keys.

8.4.2.1 Images Tab

The Images tab allows the user to view and modify the Cyclone images both in internal Cyclone memory and on external memory cards. To add a new image to the Cyclone, click on the “Add Image Internal” button and selected the image you want to add. For the changes to take effect, the “Apply Changes” button needs to be clicked, this will place the image in the Cyclone memory.

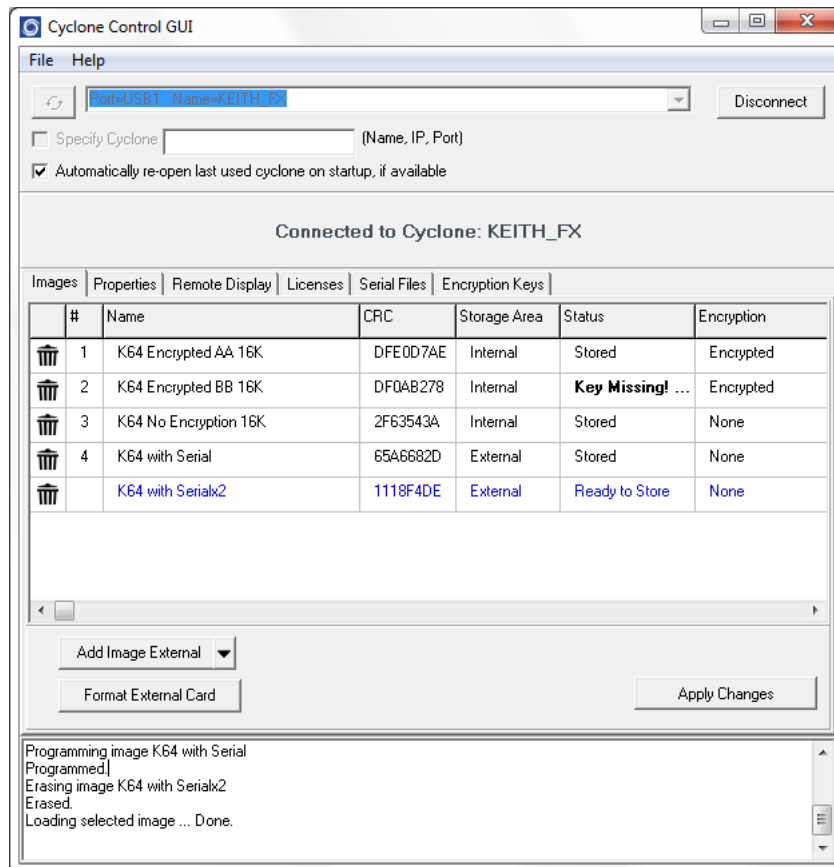

Figure 8-4: Images Tab - Image Ready to Store

CYCLONE FX programmers and **CYCLONE** programmers with the SDHC Port Activation License can also store images in external memory (an SDHC card). The storage area for the Add Image button is toggled between Internal and External by clicking on the drop down arrow on the right of the “Add Image” button. Users can also right-click on an uncommitted image to toggle the storage between Internal and External.

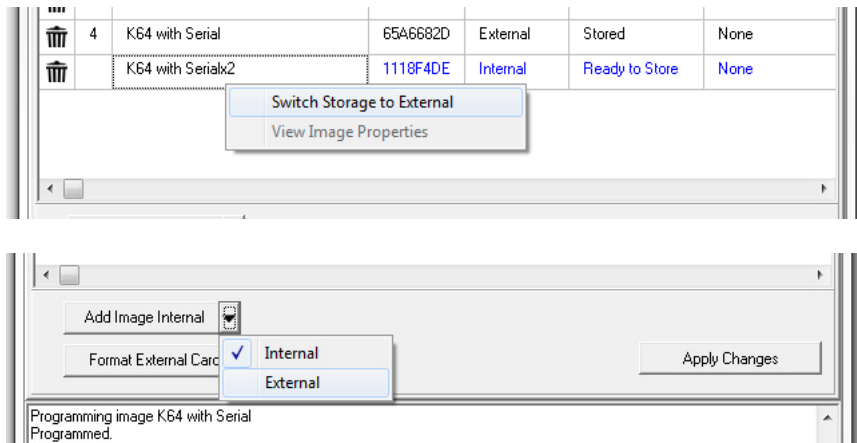

Figure 8-5: Changing Storage Area - Right Click or Drop-Down Selections

Note: An image displayed in blue is not yet committed, so disconnecting from the Cyclone before the “Apply Changes” button is clicked will discard any changes not committed.

Erasing an image can be done by clicking on the trashcan icon at the left of the image, it can also be done by selecting the image and click the DELETE key on the keyboard. The “Apply Changes” buttons must be clicked for any changes to the Cyclone to take place.

To format the external memory card click on the “Format External Card” button. This will erase all image information stored in the external card.

8.4.2.1.1 Categories

The following information is displayed for each image in the Images Tab:

Delete Image - Clicking the trash icon will designate an image for deletion. Apply Changes must be clicked to execute this action.

Number - Displays the Cyclone’s numbering for each image.

Name - Displays the Image Name.

CRC - Displays the CRC value for each image.

Storage Area - “IN” designates that the image is stored in the Cyclone’s internal memory; “EX” designates that it is stored in external memory (SDHC Card).

Status - This displays whether the image is “Stored” on the Cyclone, “Ready to store”, or “Ready to erase”. A stored image that is encrypted but missing its ImageKey will always show “Key Missing!” to indicate that the user must provision the Cyclone with this key in order to program that encrypted image.

Encryption - Displays “Encrypted” for encrypted images, and “None” for images that have not been encrypted.

For more about encrypted programming images, please see **Section 6.1.8 - ProCryption Security License Features**.

8.4.2.1.2 View Image Properties

From this tab a user can also access the image properties of images in the Cyclone. Just right click on the image then click on “View Image Properties” and a window with public image properties will pop up.

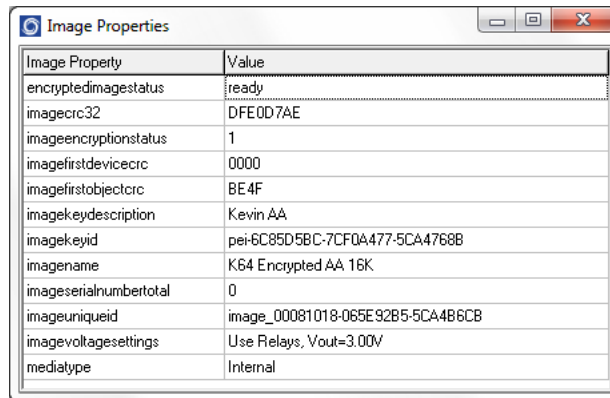

Figure 8-6: Image Properties Window

Properties like the image name, the voltage settings, image CRC, encryption info, and all current serial numbers can be viewed from this window. Use this feature to make sure your image settings are correct or check that the serial numbers change accordingly.

8.4.2.2 Properties Tab

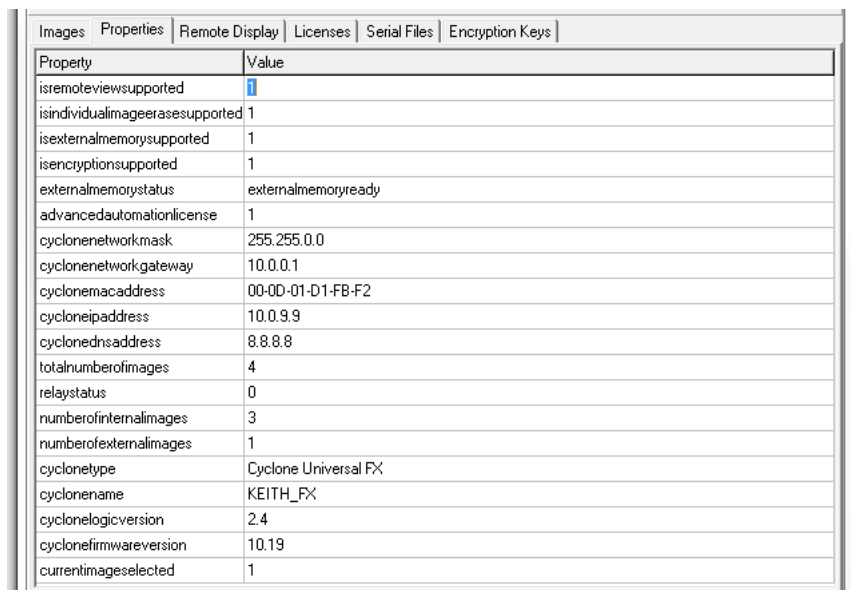

Figure 8-7: Properties Tab

The properties tab shows all the network, Cyclone and image properties. It also shows properties for the supported features of the Cyclone. From this tab the Cyclone firmware and logic versions, the cyclone type, and the number of images are available. Also from this tab some of the properties can be modified.

8.4.2.2.1 Modifying A Cyclone Property

Some properties in the Cyclone are modifiable. Only the properties that can be modified will show three dots to the right of the property when the property is selected.

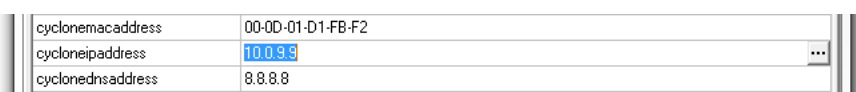

Figure 8-8: Modifying Cyclone Properties

Clicking on the three dots or double clicking on the property value will bring up an edit window. Write the new property value and click “OK”, the property window will refresh and the value

showed will be the updated value of the property.

8.4.2.3 The Remote Display Tab

This tab will show the current display of the Cyclone. The utility checks every second for changes in the display and updates the image to the current display. This image is also clickable so clicks on the virtual screen are also registered by the Cyclone.

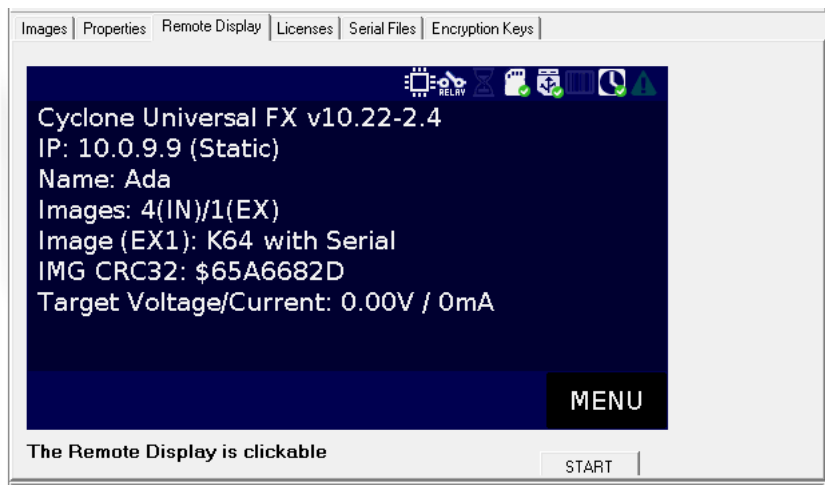

Figure 8-9: Remote Display & Control of Cyclone Screen

8.4.2.4 Licenses Tab

New licenses can be added to the Cyclone using the Licenses tab. Clicking on “Add New License” will prompt the PEmicro License Activation Form. This form takes in the Installation Code for a product and can automatically validate and register the installation.

This tab also shows the current licenses active in the Cyclone, including the Cyclone Control Advanced Automation License, SDHC Port Activation License, and ProCryption Security Activation License.

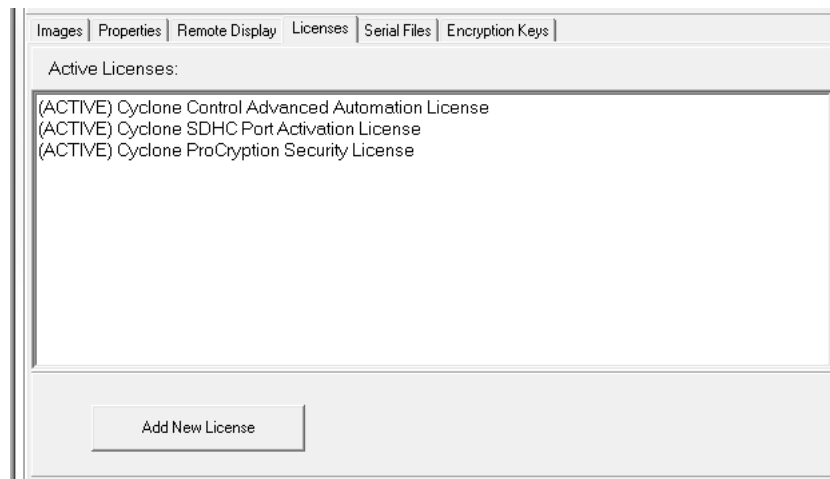

Figure 8-10: Licenses Tab

8.4.2.5 Serial Files Tab

The Serial Files Tab displays any Serial Files that are on the Cyclone. Serial Files can be “deleted” with the “Delete Serial File” button, but in this case it simply means that they will not be displayed. An image file that uses a “deleted” Serial File will simply cause the file to re-appear and resume with its next serial number.

Note: Older images may reference Serial Files that are image-specific and cannot be shared among images (like current Serial Files). These will not appear in the Serial Files tab. The Cyclone menu

can be used to make changes to the serialization of these images.

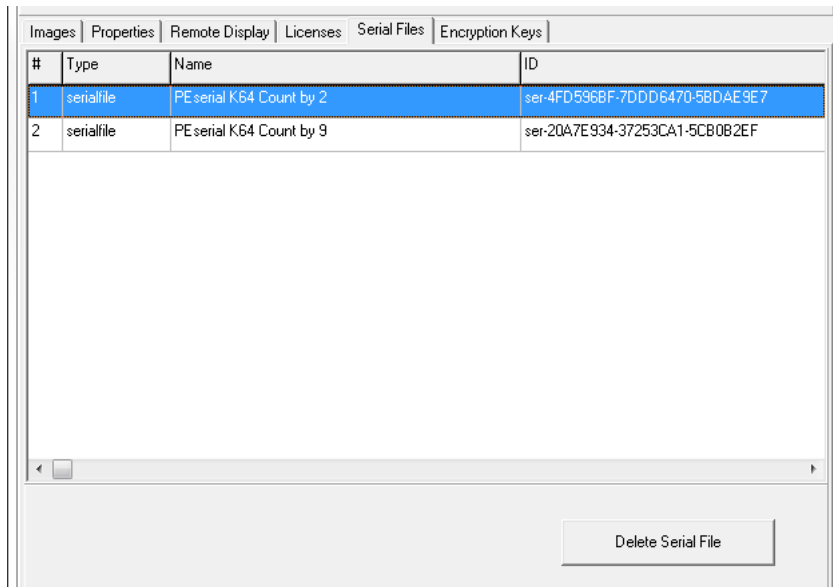

Figure 8-11: Serial Files Tab

8.4.2.6 Encryption Keys Tab

CYCLONE FX programmers and **CYCLONE** programmers with the ProCryption Security Activation License are able to encrypt programming images with a user-generated ImageKey. In order to load an encrypted image onto a Cyclone, or to program with an encrypted image once it is on the Cyclone, the ImageKey used to encrypt that image must be present on the Cyclone.

The Encryption Keys tab displays any ImageKeys that reside on the Cyclone. The Name and unique ID number for each ImageKey is shown.

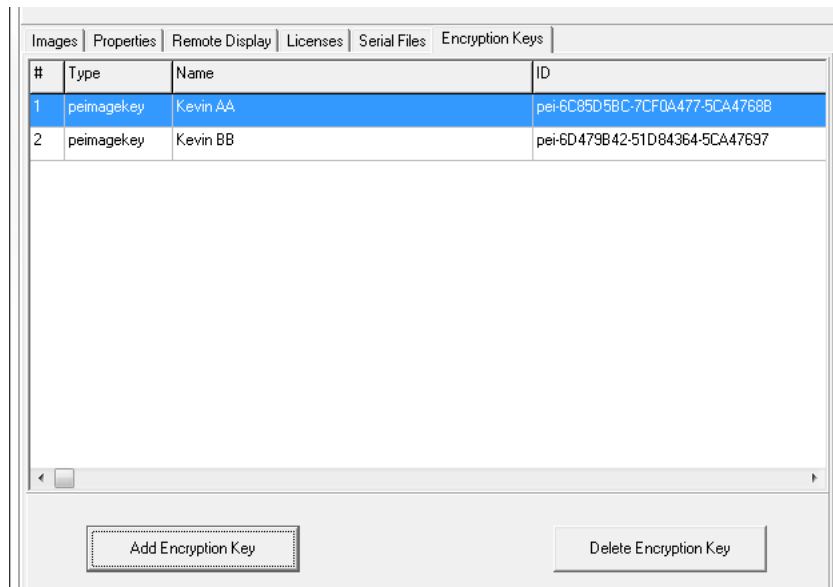

Figure 8-12: Encryption Keys Tab

The Add Encryption Key button allows the user to browse to an ImageKey that they wish to add to the Cyclone. Encrypted (eSAP) programming images cannot be loaded onto the Cyclone unless the ImageKey that was used to encrypt them is present on the Cyclone.

The Delete Encryption Key button will delete the selected ImageKey from the Cyclone. The user should bear in mind that if the ImageKey is missing for an eSAP image, that image will be locked and cannot be programmed.

8.4.3 The Status and Error Window:



Figure 8-13: Status & Error Window

This section of the Cyclone Control GUI displays the status of the utility as well as any errors during the connection or any of the actions performed by the utility. It'll show detailed errors on images that failed to be properly added or actions that require additional licensing.

This new status and error window increases the visibility of the user into the tasks the utility is performing as well as the issues that may arise.

8.5 License

The Cyclone Control Suite software does not need a license to operate when using the standard features with any touchscreen Cyclone or when using advanced features with a **Cyclone FX**. When using the advanced automation features of the SDK or Console with non-FX cyclones, a "Cyclone Control Advanced Automation License" needs to be present in the Cyclone. This advanced license is available for purchase for the Cyclone LC programmers.

Information on how to install the license for your **Cyclone LC** programmer is available in **CHAPTER 8 - CYCLONE PROGRAMMER AUTOMATED CONTROL (CYCLONE CONTROL SUITE)**.

Advanced automation features in the Cyclone Control Suite are not available for older, non-touchscreen Cyclone models (Cyclone MAX, Cyclone PRO, Cyclone for STMicro, and Cyclone Renesas). Please use the Classic Cyclone Automated Control Package when using advanced features with these Cyclones

8.5.1 Hardware Licensing

PEmicro's Cyclone licensing is hardware-based to provide the user with added flexibility. For example, a customer in Germany can configure a Cyclone for a contract manufacturer in China, without requiring the contract manufacturer to re-license PEmicro's software. The manufacturer can simply download any PEmicro software, and as long as a licensed PEmicro hardware is available on site, they can simply use the product.

Additionally, a hardware license does not require a networked or USB connection to a host PC, thereby making possible stand-alone operations that may require other licensing (such as the use of an SDHC card). Hardware licensing also simplifies the management of personal computers by IT departments. PCs can be replaced, upgraded, or re-formatted, without any impact to the functionality and /licensing in place on PEmicro's hardware.

One last beneficial feature of the hardware licensing mechanism is the fact that it requires no change to how licenses are obtained from PEmicro. It preserves backwards compatibility, and it maintains the same traditional licensing workflow that was previously used to license PEmicro software.

9 SAP IMAGE COMPILER (SCRIPTED PROGRAMMING & IMAGE CREATION)

PEmicro's Cyclone SAP Image Compiler, or CSAP, is an essential component in the Stand-Alone Programming (SAP) image creation process. It is designed to work in tandem with the Cyclone Image Creation Utility, by running in the background, but it can also be called directly by the user. The CSAP image compiler typically takes the .CFG file that was generated by the Image Creation Utility and uses it to locate and combine all of the components that will be included in the specific SAP image that is being created. However the user can also use a command line to submit a CFG file and various Command-Line Parameters directly to the image compiler. This allows users to write scripts that can automate the image creation/re-creation process.

In order for the user to do this, they will need to know what Command-Line Parameters are available and how they are used, and what items can/must be included in a CFG file, including Programming Commands and Configuration Commands. There is also a specific Command-Line Parameter that allows the user to easily substitute values inside a specific CFG file. This can enable a single CFG file to be used to create different SAP images.

9.1 Launching From the Command Line

The image compiler can be launched from the command line to create a SAP image. Below is an example of a command-line that the user might put together, along with descriptions of its various components.

9.1.1 Command-Line Example

Below is an example of using the command line to launch CSAP for ARM Cortex devices. The command line specifies where to locate the .CFG file and other necessary information.

```
>csapacmpz.exe "C:\MyWorkspace\MyProject\KL25Z128_script.cfg" /image-  
file "C:\MyWorkspace\MyProject\KL25Z128_image.sap"
```

Most command-line parameters can be used with any device, but some are specific to certain architectures or device types.

9.1.1.1 CSAP Executable

The user must first specify the particular CSAP executable that is compatible with their device. See the area of the example in green, which is specifically for ARM devices:

```
>csapacmpz.exe "C:\MyWorkspace\MyProject\KL25Z128_script.cfg"  
/imagefile "C:\MyWorkspace\MyProject\KL25Z128_image.sap"
```

Below is a list of which executable corresponds to which architecture/device type.

Target Architecture / Executable Name

ARM-based devices (all manufacturers) : CSAPACMPZ.exe
MAC71XX, MAC72XX: CSAPARMZ.exe
HC(S)12(X): CSAPBDM12Z.exe
ColdFire V1: CSAPBDMCFV1Z.exe
ColdFire V2, V3, V4: CSAPBDMCFZ.exe
MPC5xx/8xx: CSAPBDMPPCZ.exe
DSC: CSAPDSCZ.exe
HCS08: CSAPHCS08Z.exe

HC08: CSAPMON08Z.exe

MPC55XX-57XX: CSAPPPCNEXUSZ.exe

RS08: CSAPRS08Z.exe

S12Z: CSAPS12ZZ.exe

STM8: CSAPWIZ01.exe

9.1.2 Filename and Additional Command-Line Parameters

After specifying the executable, the user must also include the **[filename]** parameter, which represents the path and filename of the .CFG file. This is shown in blue in the example below. The user may also include one or more other command-line parameters. The area of the example in **violet** shows these other command-line parameters.

```
>csapacmpz.exe "C:\MyWorkspace\MyProject\KL25Z128_script.cfg"
/imagefile "C:\MyWorkspace\MyProject\KL25Z128_image.sap"
```

9.1.3 List of Valid Command-Line Parameters

Here is the listing of valid parameters:

- | | |
|------------------------|---|
| [executable] | Specifies the particular CSAP executable that is compatible with the user's device. Mandatory. |
| [filename] | A configuration file containing configuration commands and comments, default = PROG.CFG. Mandatory. |
| [?] | Use the '?' character option to cause the utility to wait and display the result of configuration in the image compiler window. If the user does not use a batch file to test error level, this provides a method to display the configuration result. This option should be the FIRST command-line option. |
| [hideapp] | This will cause the CSAP executable programmer to NOT display a visual presence while running, with the exception of appearing on the taskbar. (32-bit applications only) |
| [/logfile logfilename] | This option opens a logfile of the name "logfilename" which will cause any information which is written to the status window to also be written to this file. The "logfilename" should be a full path name such as c:\mydir\mysub-dir\mylog.log. |

Note: When using Windows, if the logfilename path or filename include any white spaces then the logfilename path and filename must be surrounded by double quotation marks.

[/imagefile imagefilename] Used when the SAP file should be saved to disk instead of stored on the Cyclone. This specifies the path and filename for the SAP file. A user may later update a Cyclone with this image file.

Note: If the image path or filename include any white spaces then the image path and filename must be surrounded by double quotation marks.

[imagecontent] This command-line parameter is a string that can be used to describe the SAP image, whether it is stored in a file or on the Cyclone. If the configuration command :DESCRIBEIMAGE is also present in the .CFG file, this will be overwritten.

[paramn=s] This is a type of command-line parameter that can be used within the .CFG file as a placeholder for data, and this data can then be specified on the command-line. Multiple scripts can potentially reference the same .CFG file, each specifying different data on the command-line.

The n is a numeral, which allows multiple parameters to be used within the same .CFG file.

See **Section 9.2.4 - Using Command Line Parameters Inside a .CFG File** for more information and examples.

9.2 Configuration (.CFG) File Contents

A Configuration (.CFG) file includes programming commands and the location of the binary files and programming algorithm to be used during programming. It may also include configuration commands and may refer to utilities that can augment the programming process, such as serialization, or setup information for use of a bar code scanner during programming.

Because the CFG file is essential to the process of creating a SAP image, the command-line used to call CSAP must always use the [filename] parameter to specify a .CFG file. This file will instruct the image compiler which components will be used to create the eventual SAP image and where to them, among other things.

9.2.1 Sample .CFG File

A .CFG file is a pure ASCII file that includes one command per line. It will always include two main types of commands: Configuration Commands and Programming Commands. It can also include a certain type of command-line parameter that can serve as a placeholder for some of the script contents.

Below is a sample .CFG for NXP's Kinetis KL25Z128 device. Lines in the file that begin with semicolons are comment lines.

The first several lines are comments that describe some of the attributes of the programming setup. The next several lines, which begin with a colon, are Configuration Commands that are read before programming. The final several lines are the Programming Commands that will be executed during the programming process.

```
; Automatically generated configuration file
; Silicon Manufacturer is NXP
; Silicon Architecture is ARM Based (Kinetis, LPC, etc.)
;
:ALLOWOUTOFRANGE 1
:DEVICE NXP_K7x_K70FN1M0M15
:USESVD 1
:DEBUGFREQUENCY 5560
:SAPGUIVERSION 352E3737
:PROVIDEPOWER
:POWERVOLTAGE 3.0
:POWERDOWNDELAY 250
:POWERUPDELAY 250
:KEEPPOWERON 0
:CUSTOMTRIMREF 31250.00
```

```

:NEWIMAGE
:DESCRIBEIMAGE Test_K70
CM
C:\PEMicro\cyclone\supportfiles\supportFiles_ARM\NXP\K7x\freescale
_k70fn1m0m15_1x32x256k_pflash.arp
SS C:\test\nxp\armcortex\mk_x_32_pflash_dflash_m5_05A0_1FFF.s19
EN ;Erase if not Blank
PM ;Program Module
VC ;Verify Checksum

```

9.2.2 Configuration Commands

Configuration Commands are commands that will be executed at startup, before the programming process. You can see configuration commands used inside a sample .CFG file above in **Section 9.2.1 - Sample .CFG File**. They listed are in the middle of the file. They always begin with a colon. A listing of valid Configuration Commands and their formats is included below.

9.2.2.1 Target Power Related Configuration Commands

9.2.2.1.1 :PROVIDEPOWER n

Processors: All (EXCEPT MON08)

Determines whether the Cyclone should provide power to the target. (This is the same as legacy option :USEPRORELAYS n).

Note: Not all hardware interfaces support this command. Valid values of n are:

- 0 : Cyclone does NOT provide power to target. (default)
- 1 : Enable Cyclone to provide power to target.

9.2.2.1.2 :POWERVOLTAGE n.n

Processors: All

Use this command if the Cyclone is providing/switching power to the target, otherwise omit this command. Specifies the target voltage as a real number. Acceptable range is from 1.6V - 5.0V.

:POWERVOLTAGE 3.3 Specifies target voltage as 3.3V

9.2.2.1.3 :KEEPPOWERON n

Processors: All

Determines whether power provided to the target should be turned off when the application terminates. NOTE: Not all hardware interfaces support this command. Valid values of n are:

- 0 : Turn power off upon exit (default)
- 1 : Keep power on upon exit

9.2.2.1.4 :POWERDOWNDelay n

Processors: All

Amount of time to delay when the power to the target is turned off for the target's power supply to drop to below 0.1v. n is the time in milliseconds.

9.2.2.1.5 :POWERUPDelay n

Processors: All

Amount of time to delay when the power to the target is turned on OR the target is reset, and before the software attempts to talk to the target. This time can be a combination of power on time and reset time (especially if a reset driver is used). n is the time in milliseconds.

9.2.2.2 Trim Related (If supported) Configuration Commands

9.2.2.2.1 :CUSTOMTRIMREF *n.nn*

Processors: All

Desired internal reference clock frequency for the “PT; Program Trim” command. This frequency overrides the default internal reference clock frequency. Valid values for “n.nn” depend on the particular device being programmed. Please refer to the electrical specifications of your device for valid internal reference frequency clock range.

Where:

n.nn : Frequency in Hertz with two decimal places

9.2.2.3 Information Processing Configuration Commands

9.2.2.3.1 :CLEARSTATUS *n*

Processors: All

Specifies the amount of time after programming, in milliseconds, before the Success indicator (LED) will be turned off.

9.2.2.3.2 :DESCRIBEIMAGE *string*

Processors: All

string This is a string that describes the SAP image. Will overwrite the command-line parameter “imagecontent” if both are present in the .CFG file.

Example:

```
:DESCRIBEIMAGE KL25Z128 TEST IMAGE
```

9.2.2.3.3 :ALLOWOUTOFRANGE *n*

Processors: All

Sets whether programming will continue when data is out of range.

:ALLOWOUTOFRANGE 1 Allows programming to continue when some data is out of range (addresses not in module). Out of range data is ignored.

:ALLOWOUTOFRANGE 0 Requires all programming data to be in range of the module. Out of range data causes an error on image creation.

9.2.2.4 Image Security Configuration Commands

9.2.2.4.1 :PROGRAMLIMIT *n*

Processors: All

Sets a limit to the number of devices that the Cyclone may program, until this limit is removed or reset.

9.2.2.4.2 :DATERANGE *mm/dd/yyyy mm/dd/yyyy*

Processors: All

Sets a starting date and ending date for Cyclone programming operations. The Cyclone will then only allow devices to be programmed on or between these two dates, until the date limit is removed or reset. Dates always refer to the Cyclone’s internal calendar. The character between the two dates should be a single space. The dates should be listed in chronological order, first to last.

Example:

```
:DATERANGE 05/10/2018 05/12/2018            Allows Cyclone programming operations on
```

9.2.2.4.3 :ERRORLIMIT n

Processors: All

Sets a limit to the number of errors that may occur while the Cyclone is programming devices. Once this limit has been reached, the Cyclone will no longer program devices until the error limit is removed or reset.

9.2.2.5 Image Launch Settings Configuration Commands

9.2.2.5.1 :BARFILE *barfile*

Processors: All

Specifies that a .BAR file will be used during programming (programming initiated by bar code scanner).

barfile Indicates the path and filename of the .bar file.

Example:

```
:BARFILE C:\PEMicro\cyclone\imageCreation\barcodeTest.bar
```

9.2.2.6 Connection Related Configuration Commands (ARM)

9.2.2.6.1 :DEVICE *string*

Processors: ARM, DSC, MAC7xxx

For ARM devices, this is a mandatory parameter that specifies the device. It is required because the debug protocol changes between manufacturers and sometimes also between families or devices.

Where:

string: represents the device and follows the “VENDOR_FAMILY_DEVICE” format.

For ARM devices, the easiest way to obtain the device ***string*** is from the Device Selection dialog in the Cyclone Image Configuration Utility software. In the PEMICRO Connection Manager, click “Select New Device” to open the Device Selection dialog. Expand the device tree to find your device, then right-click and select “Copy Device String to Clipboard.”

9.2.2.6.2 :DEBUGFREQUENCY n

Processors: ARM, ColdFire, PPC, MAC7xxx

Specifies the communications frequency with the target device.

n Frequency in Kilohertz.

9.2.2.6.3 :USESWD n

Processors: ARM, MAC7xxx

Allows the user to specify SWD (single wire debug) mode instead of JTAG mode.

0 Specifies that JTAG mode will be used during communications (default).

1 Specifies that SWD (single wire debug) mode will be used during communications.

9.2.2.6.4 :JTAGTAPNUM n

Processors: ARM, MAC7xxx

The JTAG Tap Number is the index of the target device in the daisy chain. The first device connected to TDI is index 0, the next is index 1, and so on. The index of the last device connected to the TDO of the debugger is the total number of devices in the chain minus 1.

Note: This command is mandatory for JTAG daisy chain configurations. It is also important to specify

JTAG communications using the :USESWD 0 command/value.

n Specifies the index number of a device in the daisy chain.

For more information on how to program or debug with a daisy chain setup, read:

http://www.pemicro.com/blog/index.cfm?post_id=136

9.2.2.6.5 :JTAGPREIR n

Processors: ARM, MAC7xxx

Every JTAG device has an IR register that is a certain width in bits. In the daisy chain the number of Pre-IR bits is the sum of all of the IR registers between your device and the TDO pin.

Note: This command is mandatory for JTAG daisy chain configurations. It is also important to specify JTAG communications using the :USESWD 0 command/value.

n Specifies the total length of IR registers following the target device. The first device in the daisy chain is index 0.

For more information on how to program or debug with a daisy chain setup, read:

http://www.pemicro.com/blog/index.cfm?post_id=136

9.2.2.6.6 :RSTLOWPOSTSAP

Processors: All

Drives the RESET signal LOW before and after SAP operations.

9.2.2.7 Connection Related (S08, S12, ColdFire V1, RS08, S12Z) Configuration Commands

9.2.2.7.1 :DRIVEBKGDLOW n

Processors: S08, S12, CFV1, S12Z **Note: Not RS08.**

By default, the BKGD signal **is driven low** before and after programming operations are complete.

- 0 Do NOT drive BGND low before and after programming operations.
- non-zero or missing Drive BGND signal low before and after programming operations.

Example:

:DRIVEBKGDLOW 0 Does NOT drive the BKGD signal LOW after operations are complete.

9.2.2.7.2 :RSTLOWPOSTSAP

Processors: All

Drives the RESET signal LOW before and after SAP operations.

9.2.2.8 Connection Related Configuration Commands (ColdFire V2, V3, V4)

9.2.2.8.1 :USEPST SIGNALS n

Processors: ColdFire

Specifies whether to use PST signals during debug.

- 0 Do not use PST signals.
- 1 Use PST signals.

9.2.2.8.2 :RSTLOWPOSTSAP

Processors: All

Drives the RESET signal LOW before and after SAP operations.

9.2.2.9 Connection Related (MPC5xxx, SPC5xxx) Processors

9.2.2.9.1 :DEBUGFREQUENCY *n*

Processors: ARM, ColdFire, PPC, MAC7xxx, DSC, PPCNexus

Specifies the communications frequency with the target device.

n Frequency in Kilohertz.

9.2.2.9.2 :UNCENSOR *n*

Processors: PPCNexus

This parameter should be used if 64-bit and 256-bit censorship passwords are needed to bypass security.

Note: The ASCII version of the password must have each long word separated by a dash.

n Password represented as a hexadecimal value, with no symbols or spaces

9.2.2.9.3 :RSTLOWPOSTSAP

Processors: All

Drives the RESET signal LOW before and after SAP operations.

9.2.2.10 Connection Related - DSC Processors

9.2.2.10.1 :DEVICE *string*

Processors: ARM, DSC, MAC7xxx

Describes the device being programmed.

string Describes the device being programmed.

9.2.2.10.2 :RSTLOWPOSTSAP

Processors: DSC, STM8

Drives the RESET signal LOW before and after SAP operations.

9.2.2.11 Connection Related - MON08 Processors

When using MON08 devices, the user must specify :POWERVOLTAGE and :POWERUPDELAY & :POWERDOWNDELAY.

9.2.2.11.1 :DEVICECLOCK *n*

For Class 5, 6, 7, and 8 devices. Controls whether the Cyclone should drive a clock to the target or whether the PEmicro interface should tristate its clock output. Valid values of *n* are:

0 : Clock driven by Cyclone. Must use :OUTPUTCLOCK to specify.

1 : Target self-clocked, Cyclone clock output disabled

9.2.2.11.2 :OUTPUTCLOCK *n*

Specifies the clock when :DEVICECLOCK is set to 0 (driven by Cyclone). Valid values of *n* are:

0 : 4.9152 MHz

1 : 9.8304 MHz

9.2.2.11.3 :CLOCKDIVIDER *n*

For Class 5, 6, 7, and 8 devices. Often one of the port pins of the target processor controls the ratio of the BUS clock to the External clock. Valid values of *n* are:

0 : Divide by 2 (usually and if applicable)

1 : Divide by 4 (usually and if applicable)

9.2.2.11.4 :BAUD n

Sets the baud rate to n. Serial port connection only If :BAUD is specified, include :FORCEPASS followed by :SECURITYCODE.

9.2.2.11.5 :FORCEPASS

Specifies that security should be passed on startup of the software instead of waiting for an EM (Erase Module) command. The :SECURITY code command must also be provided.

9.2.2.11.6 :SECURITYCODE hh hh hh hh hh hh hh hh

Specifies the 8 bytes of security code to use at startup which correspond to the addresses \$FFF6-\$FFF6 of the target HC08 device. The parameter for this is a string containing 8 bytes of data in HEX separated by white spaces.

9.2.2.11.7 :DEVICETYPE string

Specifies the target device family. As an example, the device type for a 68HC908KX8 would be KX. The allowed device type values are:

AB,AP,AS,AT,AZ,BD,EY,GP,GR,GR4/8,GT,GZ,JB12,JB16, JB1/8,JG,JK,JL,JR,JW,KX,LB,LD, LJ,LK,LT,LV,MR4/8,MR16/32,QB,QC,QL,QT,QY,RF,RK,SR

9.2.2.12 Connection Related - STMicroelectronics' STM8 Processors

9.2.2.12.1 :ARCHTYPE n

Processors: STM8

Specifies the STM8 family via the numeral n, where n indicates the following:

161 = STM8S/STM8A
 162 = STM8L101X
 163 = STM8L15X
 164 = STM8L16X

9.2.2.12.2 :COMMSMODE 0

Processors: STM8

Indicates that communications speed should be controlled automatically.

9.2.2.12.3 :FORCEPASS

Processors: STM8

If this command is present, read-out protection will be ignored, i.e. the target will be unsecured and the programming process will continue.

If this command is missing, read-out protection will NOT be ignored. If the device is protected the programming process will not proceed.

9.2.2.12.4 :RSTLOWPOSTSAP

Processors: All

Drives the RESET signal LOW before and after SAP operations.

9.2.3 Programming Commands

Programming Commands are the commands that will be executed during the programming process. These are the main commands that will manipulate and verify data on your device. A list of programming commands and their formats is included below.

See **Section 9.2.1 - Sample .CFG File** to view programming commands within a CFG file. The

example programming commands are at the bottom of the file.

Note: The command parameter formats *starting_addr*, *ending_addr*, *base_addr*, and *byte*, *word* are hexadecimal by default.

BM Blank check module.

BR *starting_addr ending_addr* Blank check range.

CM Choose module (algorithm) file. Note: Certain modules may require a base address to be specified

EB *starting_addr ending_addr* Erase byte range.

EW *starting_addr ending_addr* Erase word range.

EM Erase module.

EN Blank check and erase

GO Starts device running. Can be used as final command if you want the device to run for testing. Should be immediately preceded by an 'RE' command.

PB *starting_addr byte ... byte* Program bytes.

PF *feature_ID starting_addr* Program feature data. feature_ID must be: datestr, datetimestr, barcodestr, or runttestdata. See **Section 6.1.4.9 - Program Feature Data**.

PW *starting_addr word ... word* Program words.

PM Program module.

PT Program trim (devices with trim only)

RE Reset chip.

SS *path* Specify binary data file (S19/Elf/Hex) Path indicates file path to the binary.

VC Verify the programmed device using a checksum

VM *starting_addr ending_addr* Verify module.

VR *starting_addr ending_addr* Verify range.

VV *type* Verify module CRC. Type is CRC8 or CRC16.

DE *timeinms* - Delays "timeinms" milliseconds

9.2.4 Using Command Line Parameters Inside a .CFG File

The user may wish to make their .CFG files more versatile by inserting one or more placeholders into the script, and then specifying the values for those placeholders later, on the command line, when calling the CSAP executable that will references that script.

The command-line parameter /PARAMn=s can be used to insert text into a .CFG file. It can replace any part of the script including programming commands, filenames, and parameters. **n** is a numeral from 0..9, which allows you to use multiple versions of this command line parameter in a .CFG file. **s** represents a string which will replace any occurrence of /PARAMn in the script file.

As an example, the following section of a .CFG script features three instances of /PARAMn=s: /PARAM1, /PARAM2, and /PARAM3:

```
RE ;Reset the MCU
CM /PARAM1 ;Choose Flash Module
EM ;Erase the module
BM ;Blank Check the module
SS /PARAM2 ;Specify the S19 to use
PM ;Program the module with the S19
/PARAM3 ;Verify the module again
```

When the user calls the CSAP executable that will reference this CFG file they will need to specify the values of these parameters on the command line. See the example below, where the first of these parameters is used to specify a programming algorithm (.SRP), the second an .S19 file, and the third a programming command (VM).

```
CSAPACMPZ
/PARAM1=C:\PEMICRO\Freescale_MK40X256_PFlash_DFlash.ARP
"/PARAM2=C:\PEMICRO\EXAMPLE FILES\TEST.S19"
/PARAM3=VM
```

Note: Notice that /PARAM2 is enclosed in double quotation marks. This is because the parameter has a space in its value (Example Files). The surrounding double quotation marks are required in this situation, in order to indicate to Windows that it is a single parameter.

The complete example command line would be as below (note that this is one **continuous** line; no line breaks):

```
C:\PROJECT\CSAPACMPZ C:\PROJECT\GENERIC.CFG /
PARAM1=C:\PEMICRO\Freescale_MK40X256_PFlash_DFlash.ARP "/
PARAM2=C:\PEMICRO\EXAMPLE FILES\TEST.S19" /PARAM3=VM
```

9.2.5 Sample Batch File

Here is an example of how to call a command-line programmer and test its error code return in a simple batch file. Sample batch files are given for both Windows 95/98/XP and Windows 2000/NT/XP/Vista/7/8/10.

9.2.5.1 Windows NT/2000/Vista/7/8/10:

```
C:\PEMicro\CYCLONE\IMAGECREATION\IMAGECREATIONSUPPORTFILES\CSA
PACMPZ.EXE C:\PROJECT\ENGINE.CFG
PORT=USB1
if errorlevel 1 goto bad
goto good
:bad
ECHO BAD BAD BAD BAD BAD BAD BAD BAD
:good
ECHO done
```

Note: Path names of files that are relative to the CSAP executable can also be used.

9.3 CSAP Error Returns

An Error code is returned by the Image Compiler so that a script file or an application launching the Image Compiler can check for it. The error codes used are:

- 0 - Program completed with no errors.
- 1 - Canceled by user.
- 2 - Error reading S record file.
- 3 - Verify error.
- 4 - Verify canceled by user.
- 5 - S record file is not selected.

- 6 - Starting address is not in module.
- 7 - Ending address is not in module or is less than starting address.
- 8 - Unable to open file for uploading.
- 9 - File write error during upload.
- 10 - Upload canceled by user.
- 11 - Error opening algorithm file.
- 12 - Error reading algorithm file.
- 13 - Device did not initialize.
- 14 - Error loading .PCP file.
- 15 - Error enabling module just selected.
- 16 - Specified S record file not found.
- 17 - Insufficient buffer space specified by .PCP to hold a file S-record.
- 18 - Error during programming.
- 19 - Start address does not point into module.
- 20 - Error during last byte programming.
- 21 - Programming address no longer in module.
- 22 - Start address is not on an aligned word boundary.
- 23 - Error during last word programming.
- 24 - Module could not be erased.
- 25 - Module word not erased.
- 26 - Selected algorithm file does not implement byte checking.
- 27 - Module byte not erased.
- 28 - Word erase starting address must be even.
- 29 - Word erase ending address must be even.
- 30 - User parameter is not in the range.
- 31 - Error during algorithm-specified function.
- 32 - Specified port is not available or error opening port.
- 33 - Command is inactive for this .PCP file.
- 34 - Cannot enter background mode. Check connections.
- 35 - Not able to access processor. Try a software reset.
- 36 - Invalid algorithm file.
- 37 - Not able to access processor RAM. Try a software reset.
- 38 - Initialization canceled by user.
- 39 - Error converting hexadecimal command number.
- 40 - Configuration file not specified and file prog.cfg does not exist.
- 41 - Algorithm file does not exist.
- 42 - Error in io_delay number on command line.
- 43 - Invalid command line parameter.
- 44 - Error specifying decimal delay in milliseconds.
- 47 - Error in script file.
- 49 - Cable not detected
- 50 - S-Record file does not contain valid data.
- 51 - Checksum Verification failure - S-record data does not match MCU memory.
- 52 - Sorting must be enabled to verify flash checksum.

- 53 - S-Records not all in range of module. (see "v" command line parameter)
- 54 - Error detected in settings on command line for port/interface
- 60 - Error calculating device CRC value
- 61 - Error - Device CRC does not match value given
- 70 - Error - CSAP is already running
- 71 - Error - Must specify both the INTERFACE and PORT on the command line
- 72 - The selected target processor is not supported by the current hardware interface.

10 ETHERNET CONFIGURATION

This section describes the mechanism used by the Cyclone device to transact data over an Ethernet network. It primarily focuses on the User Datagram Protocol (UDP), which is a popular method for sending data over a network when the speed of a data transaction is of more concern than the guarantee of its delivery. The Cyclone takes advantage of the UDP protocol's penchant for speed, and adds an extra layer of logic to guarantee the delivery of UDP packets in order to offer a best-of-both-worlds solution.

10.1 Network Architectures

Before delving into the innards of Ethernet message passing, it is prudent to briefly describe the different network architectures in use today, and how they pertain to the operation of the Cyclone. Computers are, of course, connected to one another through intermediary devices in order to form networks. There are several classes of these intermediary devices, but they generally fall into one of the following three groups:

Hubs

At the most basic level, computers are connected to one another through a Hub. A Hub is a device with several ports that are used to connect multiple computers together. It is a repeater device – a Hub simply copies the data incoming on one port as data outgoing on the other ports. In this manner, if there are four computers connected through a Hub, and if the first computer is sending data to the second computer, then the third and the fourth computers will also receive an identical copy of that data. Hubs are usually used to set up a small Local Area Network (LAN), which may have on the order of 10 to 20 computers.

Switches

The aforementioned type of process, where the data is simply replicated onto every available port, quickly becomes inefficient for larger sized networks. For this reason, a larger sized LAN employs the usage of Switches instead of Hubs. A Switch is essentially a smart Hub, in that it limits the input and output of data to the two transacting computers.

Routers

Larger networks, such as Wide Area Networks (WANs), or the Internet for that matter, use progressively more sophisticated devices to transact data. At the core of these devices is the Router, which functions as a switch between networks.

The Cyclone performs irrespective of the connection mechanism, with one very important caveat: it needs to be set up with the appropriate network parameters for the underlying network architecture.

10.2 Network Parameters

A typical network becomes operational not after the physical connections have been established, but after network parameters in the form of IP (Internet Protocol) numbers have been assigned to the individual computers. An IP number is a unique string that consists of four numbers ranging between 0 and 255, separated by dots, e.g., 192.168.1.2. Every computer that is on a network needs to have a unique IP number. The computer uses this IP number to identify itself on the network, and also to address the recipient of its data.

Assignment of this IP number is sufficient information to transact data on a simple network connected by a hub. On a more complex network, however, routing information becomes important. The routing information consists of two more IP numbers. The first of these is called the Subnet Mask, and is used to determine whether or not the destination address resides on the same subnet (i.e., doesn't need to be forwarded to another network). The other IP number is the Gateway Address, which is the address of the computer that handles forwarding and receiving of packets to and from other networks.

Before first use, the Cyclone needs to be programmed with a unique IP number, the Subnet Mask IP number, and also the default Gateway's IP number. This can be done via the USB or the Serial port, and is described in greater detail in the "Configuring the Cyclone" section of this manual.

10.3 Internet Protocol

Once the network has been established, and the IP numbers have been assigned, data can be transacted over a network with one of several protocols. By far the most prevalent protocol is the Transmission Control Protocol (TCP), which runs on top of the Internet Protocol in what is collectively known as the TCP/IP protocol. The TCP/IP protocol was developed by the Department of Defense to connect different computers from different vendors by a “network of networks,” which has become what is known as the Internet today.

The primary purpose of the TCP/IP protocol was to prevent a complete network outage in the case of a nuclear attack, by automatically rerouting data traffic through the functioning part of the network. As such, the TCP/IP mechanism guaranteed delivery of data packets by introducing a system of acknowledgments and sequence numbers for the data packets. This mechanism, while good for transacting large amounts of data (such as email or file transfers), is unsuitable in the real-time type environment in which the Cyclone operates. Because the Cyclone needs to transact data as quickly as possible to the target, it takes advantage of TCP/IP’s alternative, the UDP/IP protocol.

Unlike TCP/IP, the UDP/IP protocol is a connectionless, single-packet protocol that sends short data packets at the expense of not guaranteeing their delivery. This makes the UDP/IP protocol efficient in real-time applications such as broadcasting video over the Internet, where the occasional loss of a frame of data is not going to hamper the overall viewing experience. Left unmodified, the UDP/IP, with its lack of guarantees for packet delivery, would be unusable in an environment where the delivery of a single byte of data needs to be guaranteed. The Cyclone firmware adds mechanisms to the UDP/IP protocol, without affecting its underlying efficiency, to guarantee delivery of data packets.

10.4 Connecting The Cyclone Device

There are two methods for establishing a connection between a Cyclone and a PC with an Ethernet cable. The most basic method is to connect the Cyclone directly to a PC, via a cross-over Ethernet cable. However, the more common method is to place the Cyclone and the PC on the same network through a Hub.

10.4.1 Connecting the Cyclone to the PC over a network

The Cyclone was intended for use on a network of multiple computers (and other Cyclones). There are many possible network configurations, and to describe them all is beyond the scope of this document. However, most configurations are a modification of a basic theme, which is that of connecting one or more PCs through a Hub to one or more Cyclones.

In order to connect these devices to the Hub, you will need to use the provided straight-through Ethernet cable. The straight-through cable, which is the “standard” Ethernet cable, is used to connect devices of different types together, such as a PC to a Hub, or a Hub to a Cyclone.

At this point it once again becomes necessary to program the Cyclone with valid IP numbers, the process for which is described in greater detail in the following section. However, it is important for the Cyclone and the PCs to have matching Subnet and Gateway IP numbers, and for each to have a unique IP number on the network. An example of a setting for above is as follows:

	<u>IP Number</u>	<u>Gateway IP</u>	<u>Subnet Mask</u>
PC1	192.168.100.1	192.168.100.3	255.255.255.0
PC2	192.168.100.2	192.168.100.3	255.255.255.0
CYCLONE	192.168.100.4	192.168.100.3	255.255.255.0
Gateway	192.168.100.3	192.168.100.3	255.255.255.0

It is important to briefly touch upon the underlying network architecture, which can be a 10Mb (Megabit), 100Mb, 10/100Mb, half-duplex, or a full-duplex connection. The details of the underlying network architecture are beyond the scope of this document, but it is sufficient to note that most modern network cards, as well as the Cyclone device, have the capability to configure themselves for the underlying network through the Auto-negotiation mechanism. Auto-negotiation is performed as soon as a network cable is connected to the device, and it sets the operating parameters of the

device to match those of the network.

10.4.2 Connecting Cyclone-to-PC via an Ethernet cable

In order to connect the Cyclone to a PC directly via an Ethernet cable, you need to use what is known as a cross-over cable. A cross-over cable, which is not provided by PEmicro, is normally used to connect two similar devices such as a PC to a PC, or a Hub to a Hub. It is a cable that has its receive and transmit wires crossed over so that the similar devices can effectively communicate with one another.

With this configuration, it is still important to assign IP numbers to both the PC and the Cyclone device. Although at first glance it may not seem necessary to assign a Gateway address in this configuration, the Cyclone was designed to operate on a network of more than two computers, and therefore it needs to be programmed with a Gateway address.

Assuming the desktop's IP number to be 192.168.100.1, this is an example of the three IP numbers that would need to be programmed into the Cyclone:

	<u>IP Number</u>	<u>Gateway IP</u>	<u>Subnet Mask</u>
PC	192.168.100.1	none	255.255.255.0
CYCLONE	192.168.100.2	192.168.100.1	255.255.255.0

For more information on programming these IP numbers into the Cyclone device, please see the following section.

10.5 Cyclone IP Setup Via LCD Menu

When the user is connecting the Cyclone via Ethernet, before the connection is established between the Cyclone and the network the menu's Home Screen will display the Cyclone's IP address as 0.0.0.0.

Once a connection has been established, the menu's Home Screen displays the Cyclone's IP address and connection setting (Static or Dynamic).

The Ethernet cable can either be attached at the start of Cyclone startup or connected after setup is complete. The connection with the network will be established when the cable is connected. If the Ethernet cable is disconnected after setup is complete, the user should be able to simply reconnect the cable to reestablish networking. However, depending on the setup of the DHCP server, if the Ethernet cable is left unplugged for a considerable time the IP address may expire and connection will have to be set up once again. This can be accomplished by restarting the Cyclone.

10.5.1 Configure Network Settings

To configure network settings for the Cyclone, navigate to the following Menu location:

Main Menu / Configure Cyclone Settings / Configure Network Settings

The following options will be available under Configure Network Settings:

- Show Current IP Settings
- Edit Static IP Settings
- Enable/Disable Dynamic IP
- Edit Cyclone Name

10.5.1.1 Show Current IP Settings

Show Current IP Settings displays the current IP settings, including:

- Current IP Mode
- IP Number
- Mask
- Gateway

- MAC Address

If you are in Static IP mode, these settings (excluding the MAC address) may be changed by tapping on them. In this case a tap will take you to the Edit menus. If you are in Dynamic IP mode, tapping will show a message that the Cyclone settings cannot be changed.

Dynamic vs. Static

There are two schemes for assigning IP addresses. One is the Static IP addressing mode. This involves the user manually setting the IP address for every device on the network. In this case, it falls to the user to ensure the IPs assigned do not conflict and are within the boundaries of the network. The other is the Dynamic Host Configuration Protocol (DHCP). This involves setting up a separate server to manage the IP addresses. The server is given a list of valid IP addresses for the network. Using a predetermined set of rules, each new device that wishes to connect to the network is given an IP address by the server. This takes the task of managing the validity and uniqueness of IP addresses out of the user's hands and relegates it to the server. **Cyclone LC** programmers are capable of using either Static IP addressing or DHCP.

Note: The current IP settings may also be viewed/edited by navigating to:

Main Menu / Status / Show Current IP Settings

10.5.1.2 Edit Static IP Settings

This allows editing of IP, Mask, and Gateway in Static IP mode. In the edit dialogs, the user must enter a valid IP address to continue:

Format

xxx.xxx.xxx.xxx

Where:

0 <= xxx <= 255

10.5.1.3 Enable/Disable Dynamic IP

Opens a dialog to toggle the IP settings between Static and Dynamic. Once an option is selected a message is displayed indicating that the Cyclone must be reset for this option to take effect. The reset button on the front side of the Cyclone may be used.

10.6 Configuring Cyclone Network Settings using the Cyclone Control GUI

Before the Cyclone device transacts data on an Ethernet network, it will need to be configured with the relevant network parameters. This configuration can be done in the "Properties" tab of the Cyclone Control GUI.

To access the "Properties" tab, select the Cyclone from the drop-down list in the Cyclone Control GUI and click on "Connect". The "Properties" tab will be accessible once the Cyclone is open.

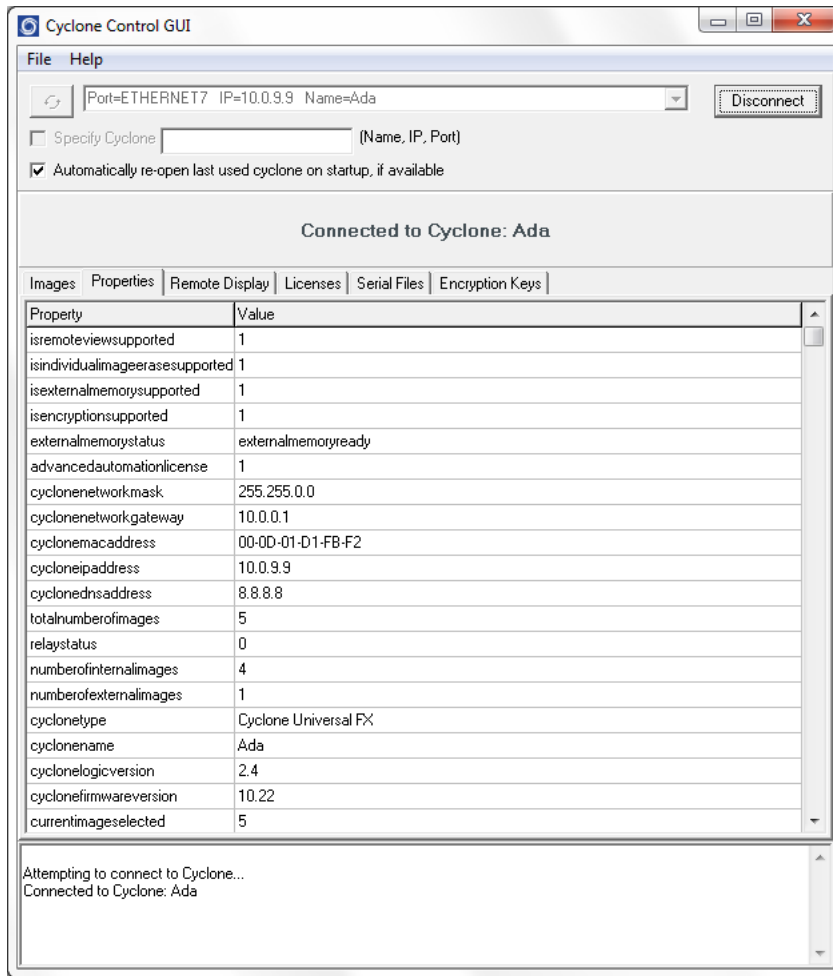

Figure 10-1: Cyclone Control GUI: Properties Tab Selected

From this tab, all Cyclone and Network properties can be accessed. Some of this properties are modifiable, including all the properties needed for network configuration. A property that can be edited will show three dots to the right of the property when you select it by clicking on its box. You can click on the three dots or double click on the property value to bring up the edit window.



Figure 10-2: Dots Displayed At Right When Property Selected

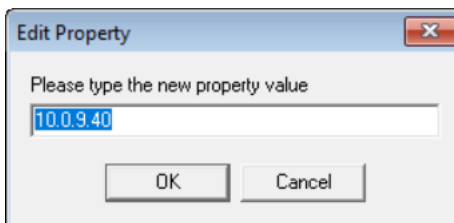

Figure 10-3: Edit Property Window

Once the "OK" button is pressed, the values of the property will be updated in the Cyclone and the value of the property in the Cyclone Control GUI will be refreshed showing the new value.

11 SAP IMAGE ENCRYPTION

CYCLONE FX programmers and **CYCLONE** programmers with the ProCryption Security Activation License allow users to create RSA/AES encrypted programming images that use their own uniquely generated ImageKey. These encrypted images may only be used to program when on Cyclones that are also pre-configured with the same ImageKey. This keeps the user securely in control of both their IP and the programming process.

11.1 Overview

PEmicro uses a combination of industry-standard RSA and AES encryption technologies to encrypt images. When a programming image has been encrypted it requires two different asymmetric keys to be decrypted. The first is a user generated RSA encryption Key that was specified when the programming image was generated. The second is a native key which comes pre-installed in the Cyclone (and does not exist on the PC). This means that an encrypted image may (A) only be loaded onto a Cyclone which holds a copy of a user generated ImageKey, and (B) only be decrypted for programming while on a Cyclone which holds a copy of a user generated ImageKey. The Cyclone Control Suite (GUI, Console, SDK) allows the user to add and delete ImageKeys from Cyclones, much like programming images may be added or deleted. While many users will use only a single ImageKey to encrypt all of their images, Cyclones may have many different keys loaded.

Encrypted images are stored in the Cyclone in their encrypted form. If the ImageKey needed by a programming image is deleted from the Cyclone, the Cyclone loses the ability to load any images encrypted with that ImageKey or program any encrypted images encrypted with that ImageKey that are already loaded. Adding the ImageKey back into a Cyclone gives that Cyclone access to those stored encrypted images which require that ImageKey.

Encrypted images can safely be sent through electronic means to production facilities since they are unusable without a Cyclone which has been pre-loaded with the appropriate ImageKey.

ImageKeys on the PC are themselves partially encrypted so that certain pieces can only be used on a Cyclone. Even with this, they should be handled with care as they can be loaded into any Cyclone.

11.2 Encrypting/Decrypting a Programming Image

The Cyclone Image Creation Utility can generate ImageKeys that are used to encrypt SAP images. The steps that are necessary to generate ImageKeys, encrypt SAP images, provision Cyclones to decrypt, and program with encrypted SAP images are detailed in **Section 6.1.8 - ProCryption Security License Features**.

11.3 What is Encrypted in an eSAP File, and How

An encrypted image (eSAP) contains three distinct sections: an informational header, a configuration section, and a stand alone programming (SAP) data section. The ImageKey encrypts each section in different ways to control access to each portion of the eSAP file.

The three eSAP sections are:

1) Informational Header

This section includes the description of the eSAP Image, its unique ID, the ID and name of the ImageKey used to encrypt it, and a checksum of the data. This section is not encrypted.

2) Configuration Section

This section contains a copy of the configuration settings used to generate the Image including which algorithm was used, power settings, clock settings, script files, and paths to the binary data files. No programming data from the user's data files is included in this section. This section is encrypted in such a way that if a user has the appropriate ImageKey on the PC, they may import the configuration information from an eSAP file into the Image Creation Utility. This is useful for seeing the settings used to generate an image, and, if the user has all of the data files needed, generate a new programming image file with the same

configuration.

3) Stand Alone Programming (SAP) Data

This section contains all of the information a Cyclone needs to program a target as specified in the image creation process. This includes all programming data, algorithms, scripts, settings, etc. This section is encrypted with several keys, including the user generated asymmetric key as well as a native asymmetric key used by the Cyclone. Once encrypted, this section may not be decrypted except by the Cyclone during the programming process.

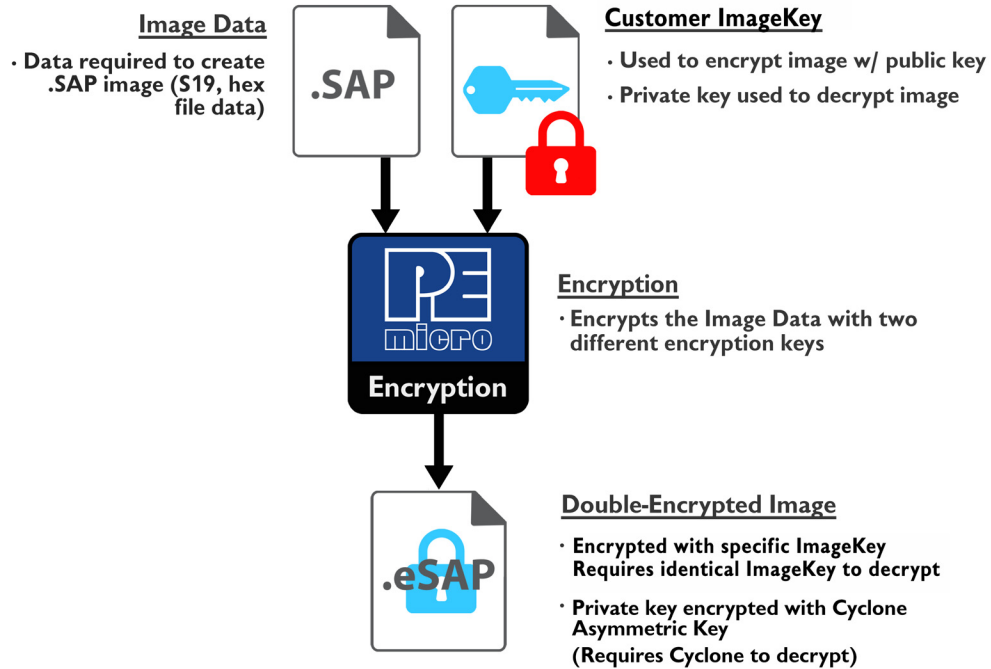

Figure 11-4: SAP Encryption

The end result of the encryption used to proceed the Stand Alone Programming Data is that the section can only be decrypted and used internally on a Cyclone which has a copy of the specified ImageKey provisioned within it. This eSAP section cannot be decrypted on a PC even with the ImageKey

11.4 Managing Encryption For Production Programming

The steps needed to encrypt programming images using the Cyclone Image Creation Utility are detailed in **Section 6.1.8.1 - SAP Image Encryption**. This section details how to successfully implement the use of these encrypted (eSAP) images into the production programming process.

11.4.1 Provisioning a Cyclone with an ImageKey

Cyclones that have been provisioned with an ImageKey are the only Cyclones that are able to load and program eSAP images encrypted with that ImageKey. When the user determines that one or more Cyclone programmer(s) will have access to an encrypted image, they need to load the ImageKey that was used to encrypt that image onto the Cyclone. This can be done with the Cyclone Control Suite GUI, Console, or SDK. Instructions on the use of these Control Suite options is explained in **CHAPTER 8 - CYCLONE PROGRAMMER AUTOMATED CONTROL (CYCLONE CONTROL SUITE)**.

Figure 11-5 shows the Cyclone Control GUI with the Encrypted Keys tab selected.

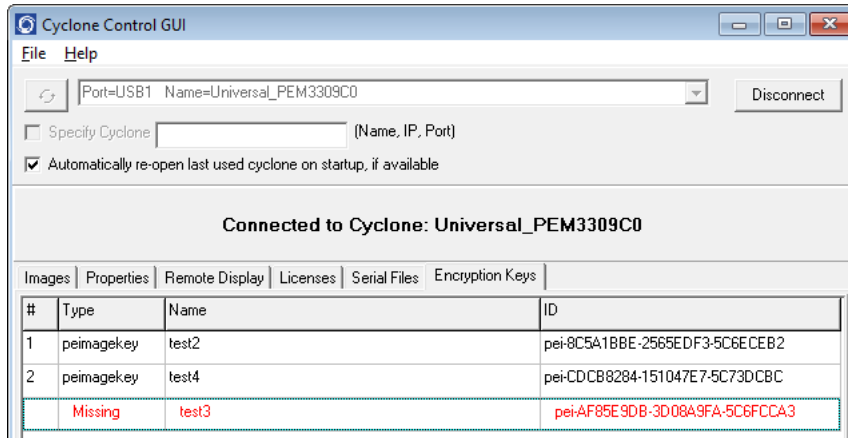

Figure 11-5: ImageKey Listing for Connected Cyclone

This tab displays any ImageKeys that are present on the Cyclone to which the user is connected.

Note: If there is an encrypted SAP image on the Cyclone whose corresponding ImageKey has been removed, the required ImageKey will be displayed as “Missing,” along with its Name and ID.

To provision a Cyclone with an ImageKey, the user simply clicks the “Add Encryption Key” button and browses for the ImageKey that they wish to load onto the connected Cyclone.

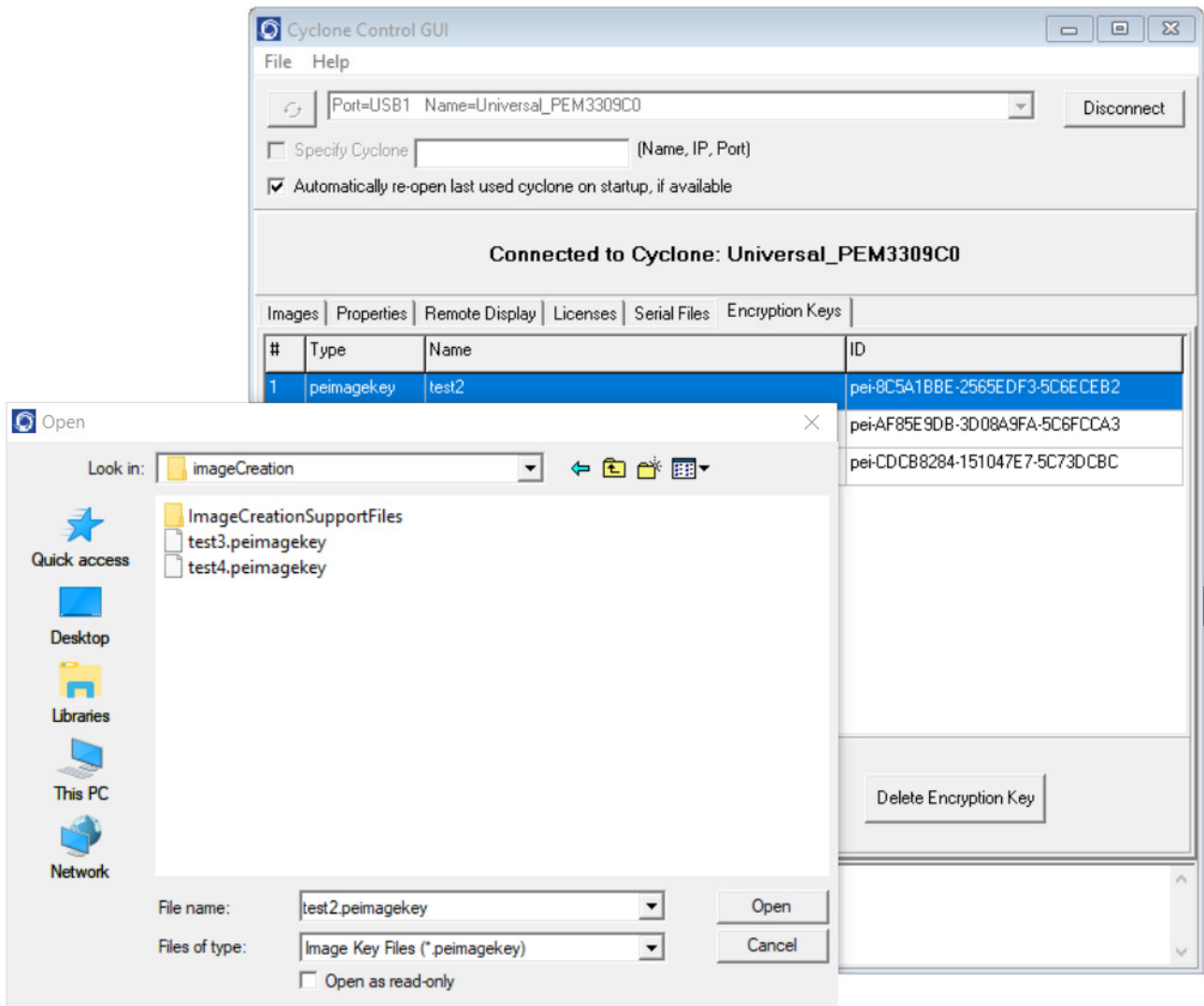

Figure 11-6: Browse for ImageKey

11.4.2 Removing ImageKeys From A Cyclone

It is also easy to remove an ImageKey from the connected Cyclone. The user selects the ImageKey that they wish to delete and hits the “Delete Encryption Key” button.

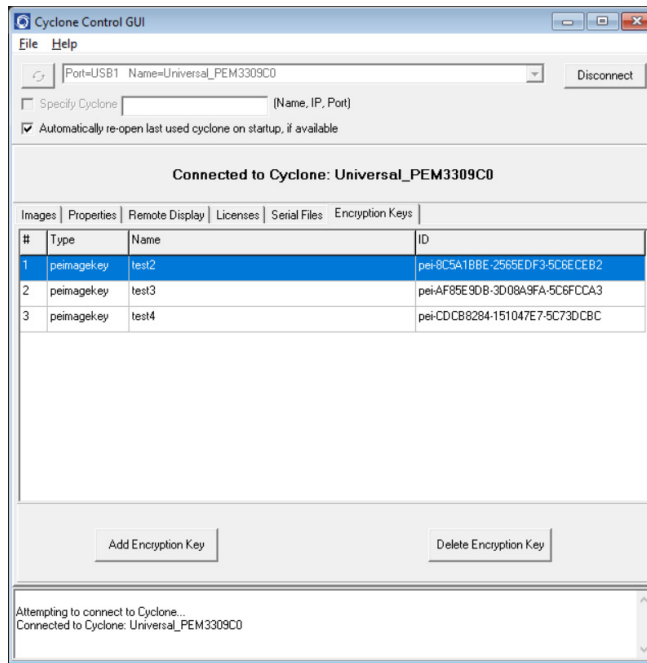

Figure 11-7: ImageKey Selected for Deletion

If the ImageKey that was selected for deletion is one that is required to decrypt one or more eSAP images that are on the connected Cyclone, a warning message will be displayed when the Delete button is pressed. The user may then cancel the deletion or confirm that they wish to proceed.

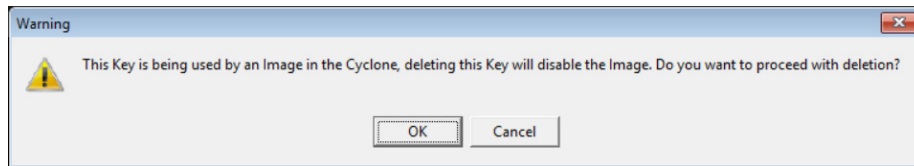

Figure 11-8: Warning: ImageKey Used By SAP Image on Connected Cyclone

11.4.3 Loading and Programming with Encrypted SAP Images

From the user's perspective, loading an eSAP file with the Cyclone Image Creation Utility and programming with that eSAP file looks the same as loading/using a SAP file which is not encrypted (as long as the appropriate ImageKey exists on the Cyclone).

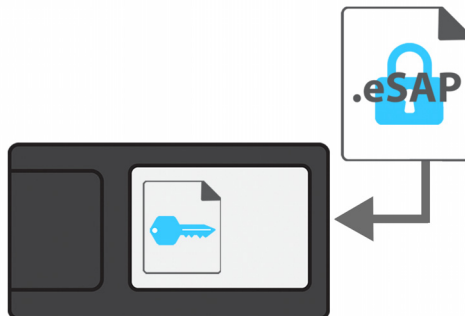

Figure 11-9: Load Encrypted Image (eSAP) onto Cyclone with Corresponding ImageKey

When the user attempts to load an encrypted programming image onto a Cyclone, the Cyclone will

refuse to load the image unless the appropriate ImageKey resides on the Cyclone. If the ImageKey is present, the Cyclone will load the eSAP File and automatically decrypt it using both the matching ImageKey and the Cyclone's internal decryption mechanism.

A user may create and use multiple ImageKeys and corresponding eSAP images on a single Cyclone.

The decryption process is transparent to the user when the Cyclone goes to program the target. The decrypted programming image appears as usual on the Cyclone menu screen. The user can now program devices using the unencrypted SAP Image.

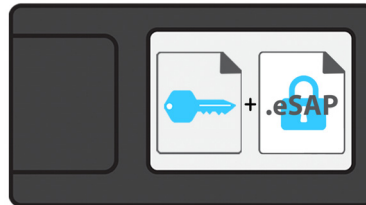

Figure 11-10: Decryption Occurs Automatically For Programming

11.4.4 Encryption Status of SAP Images

In the Images tab of the Cyclone Control Suite GUI the user can view the encryption status of SAP images that reside on the connected Cyclone. **Figure 11-11** shows the Cyclone Control GUI with the Images tab selected.

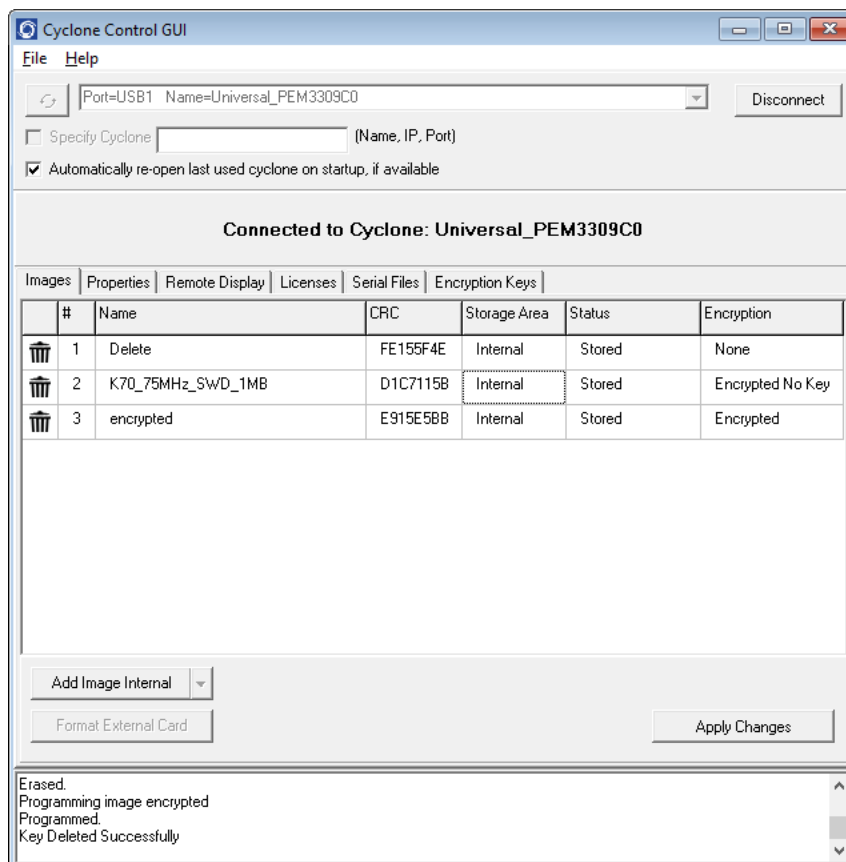

Figure 11-11: SAP Image Listing for Connected Cyclone

The rightmost column, labeled Encryption, displays whether each SAP image is unencrypted (“None”), encrypted with the required ImageKey present (“Encrypted”), or encrypted but missing the ImageKey required to decrypt (“Encrypted No Key”).

11.5 Safer Production That's Easy To Implement

SAP Image encryption with Cyclone programmers is simple to implement and helps keep valuable intellectual property safe. Protected programming images can safely be sent electronically to remote production facilities. This adds much needed convenience and peace of mind to the production process.

12 AUTOMATIC SERIAL NUMBER MECHANISM

When producing a microcontroller- or microprocessor-based product, it is often useful to program a unique serial number into the permanent memory (FLASH) of the product.

PEmicro offers a serial number mechanism to automate this process. Each time you issue a serialization command in the programming software, the current serial number is programmed at a specified address. In addition, the serial number is incremented to the next available serial number and saved for future serialized programming operations.

The Cyclone adopts this automatic serial number mechanism for its stand-alone operations. The user can create a Serial File using PEmicro's Serialize Utility and then include commands in the programming sequence of the programming image to implement that Serial File. If needed, adjustments can later be made to the serial number of a programming image by using the Cyclone menu screen (see **Section 5.2.2.3 - Serial Numbers**).

12.1 Understanding Serialization

The automatic serial number mechanism supports serial numbers from 1 to 16 bytes in length. Each byte of a serial number ranges between a lower and an upper bound. This approach allows the individual bytes of the serial number to have distinct properties. Some of the forms these properties can take are:

Type	Lower Bound (hex)	Upper Bound (hex)
Constant	Constant	Constant
Binary	00	FF
ASCII Printable	20	7E
ASCII Numeric	30	39
ASCII Upper Case Letter	41	5A
ASCII Lower Case Letter	61	7A
Other	XX	YY

Each serial number and its properties are stored in a separate file. Any file name can be used for the serial number file, however the extension .ser is normally appended because it makes it simpler to locate the file.

A utility called SERIALIZE has been developed to make it easy to create, visualize, edit, and maintain these serial number files.

12.2 Serialize Utility

The serialize utility allows the user to create a serial number file with a serial number that is anywhere from 1 to 16 bytes long. Each byte may be bounded as a full binary or as a Number, Constant, Alpha Uppercase, Alpha Lowercase, or ASCII printable character. The serial number file also has a field for a starting hex address that may range from 00000000 to FFFFFFFF. Serial numbers can be programmed in order or in reverse order.

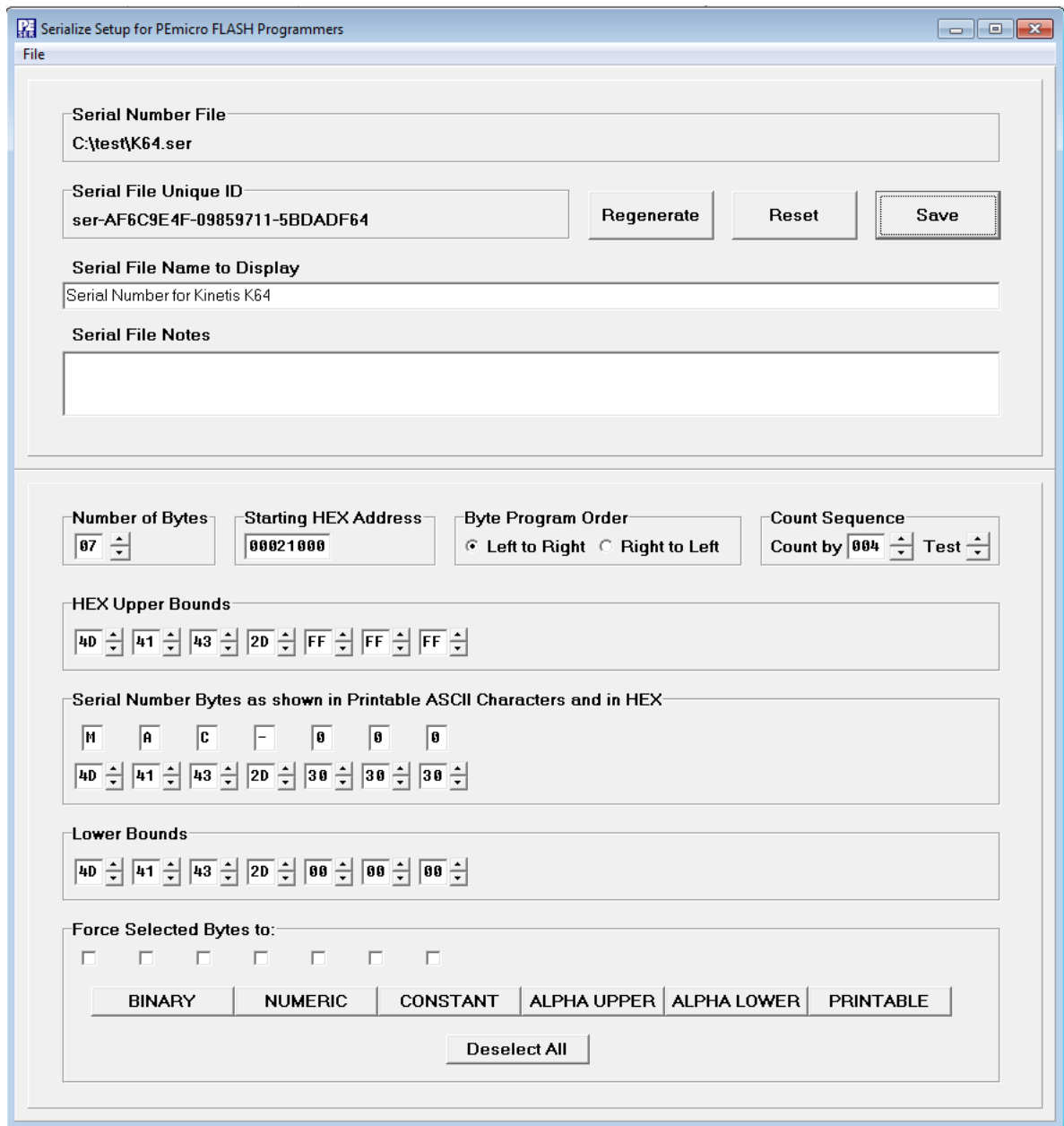

Figure 12-1: Serialize Main Screen

12.2.1 Startup And File Options

On startup, the Serialize program will automatically open the last file saved. If no file has been saved, it will default to blank.

- Reset Button - Lets you reset to a screen with only a single serial number byte defaulted to binary (00), Hex Address 00000000.
- Regenerate Button - Preserves serial number bytes and bounds but assigns a new Serial Number Unique ID
- Save Button, File→Save - Brings up a dialog to which is set to save to the current serial file configuration.
- File→Save As - Brings up a dialog to select any file
- File→Load - Brings up a dialog to select a previously saved file

12.2.1.1 Reset

Instructs the program to start editing a NEW (as yet un-named) serial number file. It will throw away the information for any serial number currently being edited unless that information has been saved (Save Button). The new serial number is initialized with one (1) byte of binary.

12.2.1.2 Save

Pops up a Save dialog with the current serial number being edited into the file name and path as shown in the Serial Number File window. If a file name has not been provided, a dialog will pop up to allow the user select a file name. Save will save any setup information in the file Serialize.ini. This file will initialize the setup information the next time the program is started.

12.2.2 Serial Number File

Displays the path and filename of the open Serial File, if saved.

12.2.3 Serial File Unique ID

Displays the unique ID associated with the Serial File. A unique ID is generated anytime a Serial File is created or modified. Multiple programming images are able to share the same serial numbers by referencing the same ID number (see **Section 13.6 - Shared Serial Numbers**). The user can click the “Regenerate” button to assign a new unique ID to the current Serial File.

12.2.4 Serial File Name To Display

The name that will appear in the JSON viewer, Cyclone menu, and in the Name field of the Cyclone Control GUI. A descriptive name can help to easily differentiate Serial Files.

12.2.5 Serial File Notes

Allows the user to save notes regarding the Serial File. These will appear in the JSON viewer when viewing the properties of the Serial File, see **Section 13.3 - Serial File Properties**.

12.2.6 Number of Bytes in Serial Number

The up and down arrows allow the user to add or delete bytes for the serial number, the maximum in hexadecimal = 0x10 (16 base ten), the minimum = 1.

- Up Arrow Click - Adds new bytes to the Serial Number. Each byte added appears as a new column in the serial number representation. Added bytes are input as Binary Bytes, i.e. the upper bound is FF and the lower bound is 00.
- Down Arrow Click - Deletes bytes from the right end of the Serial Number. Any previously entered byte properties are lost.

12.2.7 Starting HEX Address

Assigns the starting address (in hexadecimal) of the device memory where the serial number will be programmed.

12.2.8 Count Sequence

This window lets you test the serial number by counting up or down through the sequencing of the serial number. The serial number will roll over the upper bounds of the highest serial number back to the lower bounds of the serial number, and vice versa.

- Up Arrow Click - Counts the serial number up.
- Down Arrow Click - Counts the serial number down.

12.2.9 Serial Number Bytes as Hex

There is one display column for each byte in the serial number shown as printable ASCII characters. Non-printable ASCII characters are indicated by a blank gray box.

- Up Arrow Click - Counts the serial number up.

- Down Arrow Click - Counts the serial number down.
- Click into the edit Box to enter any number within range. Values entered will be limited by the upper and lower bounds.

12.2.10 Hex Upper Bounds

There is one display column for each upper bound of the byte in the serial number in hex.

- Up Arrow Click - Increases the upper bound by one with a maximum of FF Hex.
- Down Arrow Click - Decreases the upper bound by one with a minimum of the current serial number byte value.
- Click into the edit Box to enter any number within range (from the Serial number value up to a maximum of Hex FF).

12.2.11 Hex Lower Bounds

There is one display column for each byte of the lower bound of the serial number in hex.

- Up Arrow Click - Increases the lower bound by one with a maximum of the current serial number byte value.
- Down Arrow Click - Decreases the lower bound by one with a minimum of 00 Hex.
- Click into the edit Box to enter any number within range (from the Serial number value to a minimum of 00 Hex).

12.2.12 Binary, Numeric, Constant, Alpha Upper, Alpha Lower, and Printable

Checkboxes at the bottom will select properties to set for each serial number byte. Selections will be highlighted in yellow. The buttons below may be used to set the boundary type for the selected serial byte(s).

12.2.13 Byte Program Order

The user can choose whether the serial number increments from left to right, or from right to left, in the Byte Program Order section.

12.3 Serial File Properties

Serial File properties are easy to access, as the generated serial file is stored in JSON format. This makes it simple for the user to save and parse the information.

Note: Serial Files in JSON format are compatible with **Cyclone LC** firmware version 10.13 and later.

Users that wish to retrieve the original text serial number format can parse out the JSON file:

```
object->pesettings-> serial_number_definition -> legacyv1encoding
```

12.3.1 Serial File Example

An example file is provided, Example.ser, located in the Image Creation folder of your installation directory. Below is a screen snapshot of the saved serial file as seen from a JSON viewer.

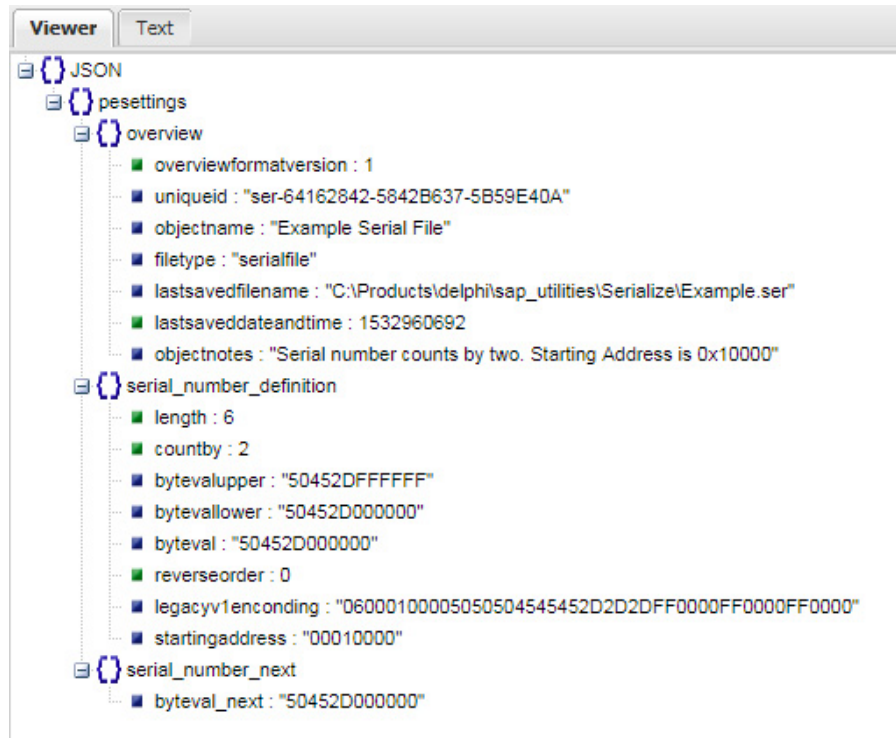

Figure 12-2: Example Serial File In JSON Viewer

12.4 Serial Number Handling

The **Cyclone LC** firmware implements the automatic serial number mechanism (see **Section 5.2.2.3 - Serial Numbers**). The same serial number files are used with the Cyclone Image Creation Utility, and the same commands are used to specify the serial number file and initiate serial number programming and incrementation. The serial number data structure is saved in the SAP image. Once a “PS” command is carried out, a serial number is programmed into the target. Only after all operations have been completed successfully does the Cyclone firmware automatically increment the serial number and store it in the Cyclone’s flash for internal images (or external CompactFlash for external SAP images).

The CS and PS commands are not present in the Cyclone Image Creation Utility until a valid programming algorithm is specified.

To complement the Cyclone’s usage in production environments, the Cyclone supports multiple serial number structures for each programming algorithm block. Each SAP image may contain multiple programming algorithms for every memory module it needs to program, and each programming algorithm block may contain multiple serial number structures. The SAP image sequence below illustrates this briefly:

```

CM algorithm_file_1
SS object_code_1
EM
PM
VC
CS serial_file1.ser
PS
CS serial_file2.ser
PS

```

```

CS serial_file_3.ser
PS
CM algorithm_file_2
SS object_code_2
EM
PM
VC
CS serial_file4.ser
PS
CS serial_file5.ser
PS

```

12.4.1 Invoking A Serial File Via Command-Line

The command to invoke the serial number file in PE micro’s interactive programming software is “CS Choose Serial File”. The command to actually program the serial number to target and automatically increment the serial number afterward is “PS Program Serial Number”.

PE micro’s command line software uses the same commands in a command line fashion to invoke the serial number file, initiate its programming, and increment:

```

CS serial_number_file.ser
PS

```

12.5 Creating A SAP Image With Multiple Serial Numbers

In the example shown in **Figure 13-3**, a SAP image was created that will select and program two different serial numbers into different locations in memory as part of the programming sequence. The first serial number counts by two with starting address 0x00020000 and the second serial number counts by four with starting address 0x00021000.

As indicated by the programming sequence, first the Algorithm is selected, followed by the S19 file. The part is erased, and then the s19 is programmed into the device. Once this is done, the first serial file is selected and programmed, and then the second serial file. These same unique serial numbers may be used by other SAP images, and each program will increase the serial number by the designated count defined in the serial number file.

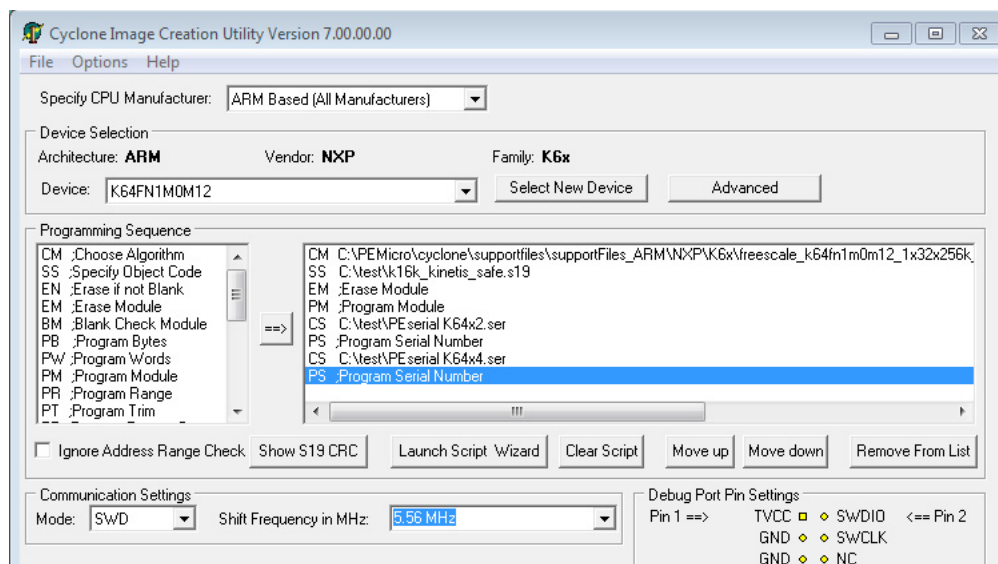

Figure 12-3: Cyclone Image Creation Utility: Serial Files In Programming Sequence

12.6 Shared Serial Numbers

An important feature of the Serialize utility is that it automatically creates a Unique ID anytime a serial file is created or modified. This allows Stand-Alone Programming (SAP) images stored on a Cyclone to share serial numbers that reference the same unique serial number ID. There are several cases where this is very useful. The first is when a user may want to update their firmware for a product to a new version but needs the serial number to have persistence. The user may also have different products that need to be programmed with different firmware, but need to have those products draw from the same serialization sequence.

Note: Shared serial numbers require **Cyclone LC** firmware version 10.13 and later.

12.6.1 Example

This section describes how a user might configure multiple SAP images on their Cyclone to share the same Serial File.

12.6.1.1 View and Edit SAP image Via Cyclone Control GUI

In **Figure 13-4**, the Cyclone Control GUI has been launched and is looking at the image contents of the Cyclone. In this case it shows that the Cyclone named Colossus contains four different SAP images. To view properties of a particular image properties, the user can simply right click on the desired image and select "View properties" which will pop up an image properties window. In this case it shows Image "Kinetis K64 PE S2 and Mac S4." The Image Unique ID is visible, as well as the two serial numbers and their respective Unique IDs. It also shows the next serial numbers (in ASCII representation) to be programmed upon launch: PE-000 and MAC-00, respectively.

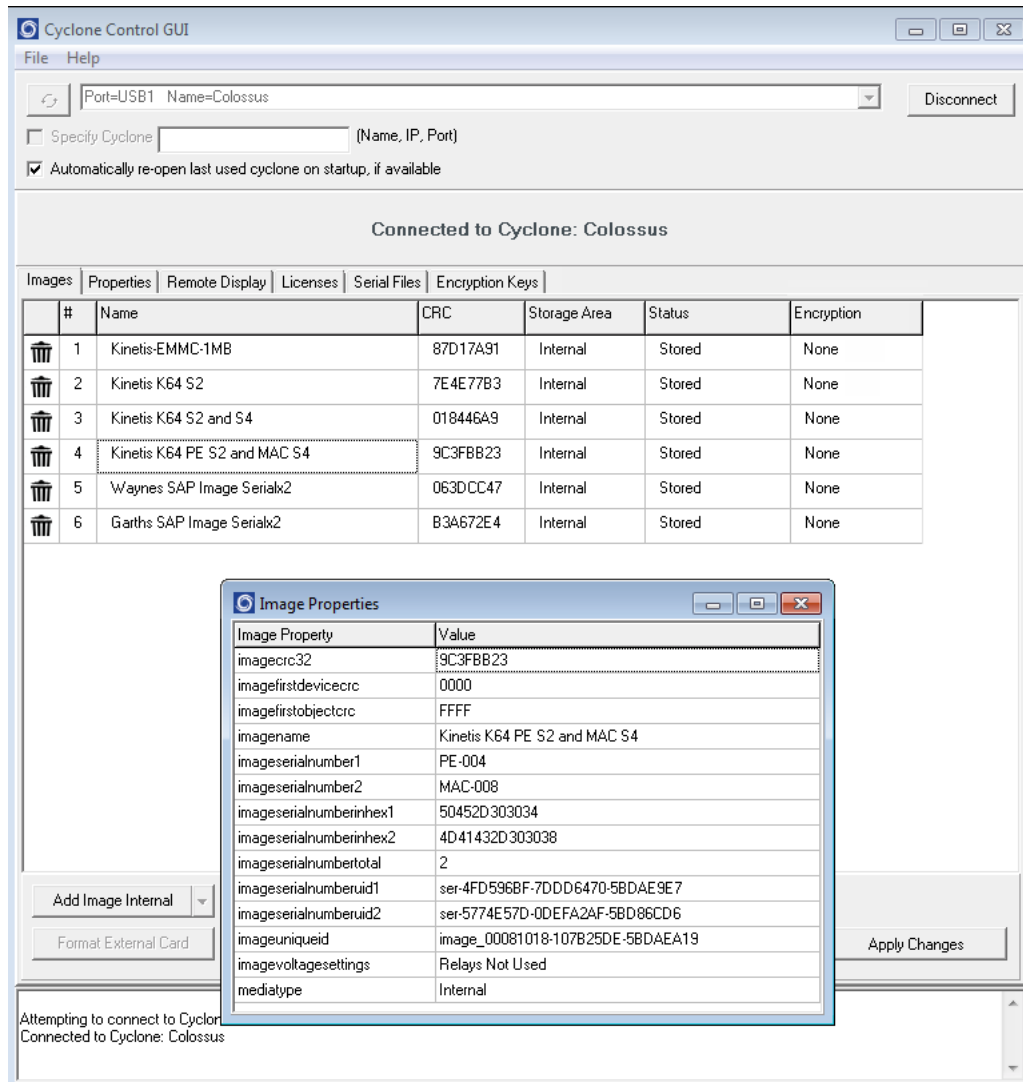

Figure 12-4: Cyclone Control GUI: Image Properties Window

Deleting the image will not delete the associated serial number as other images stored on the Cyclone may be using that same serial number. The serial number is tracked on the Cyclone by the *imageuniqueid* JSON property. If any image is added back onto the Cyclone with that same Serial Unique ID, it will continue to track with that same serial number at the latest count. So if a user has a new version of their firmware, they can create a new SAP image that uses the same serial number as the previous firmware (referenced by same serial unique ID) and the programming will continue the serial number sequence from the current serial number state since that serial file is stored on the Cyclone.

Once a SAP image is loaded with a serial file, and it is selected as the current image on the Cyclone, it is possible to adjust the serial count. This is done by navigating through the following screens on the Cyclone.

Menu → Current Image Options → Serial Number

If the image has more than one serial number incorporated into the SAP image, select the Serial number which is to be modified. Otherwise just select 'Modify Serial'.

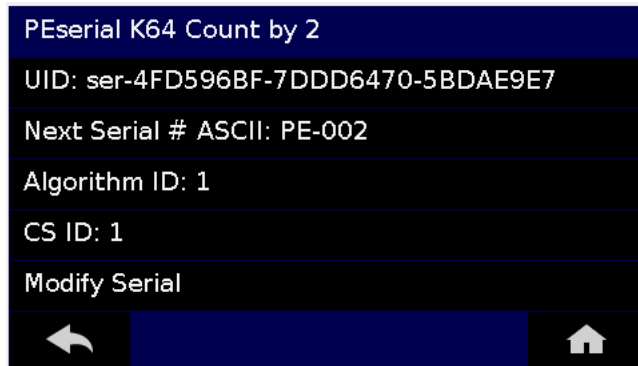

Figure 12-5: Cyclone Menu Selection

It is possible to Decrease or Increase the Next Serial by -10, -1, +1, +10. This is often done to address issues in the production process, such as during initial setup.

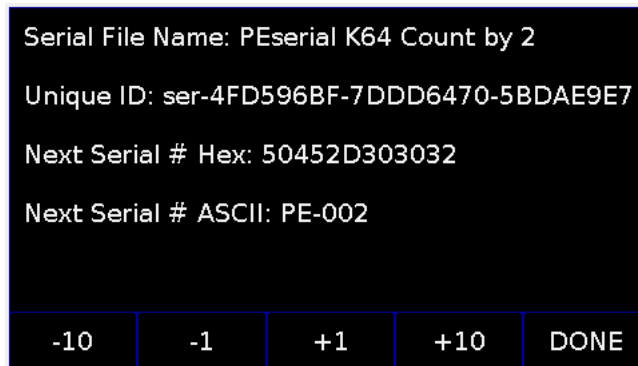

Figure 12-6: Increase or Decrease Serial Number

Note that the Cyclone Control GUI has the ability to show all the Serial Files stored on the Cyclone. This is done by opening a Cyclone, and then navigating to the Serial Files Tab, as shown in **Figure 13-7**. The Serial File tab has a Delete Button at the bottom which will remove the selected serial file from view and reset the tracking of the serial number to its original state. This does not actually delete the serial file. Once any programming is initiated using this 'deleted' serial file, the serial file will reappear back in the list and program using the original serial number.

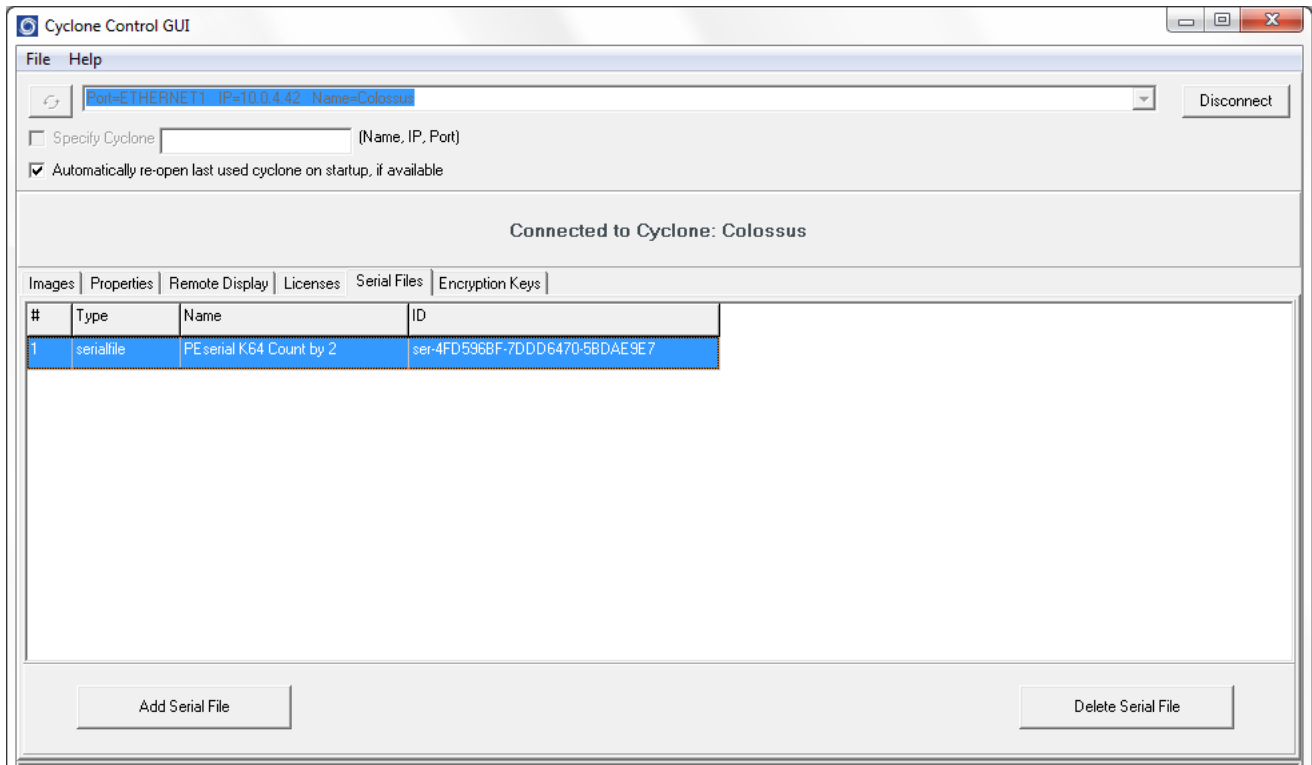

Figure 12-7: Cyclone Control GUI: Serial Files Tab

12.6.1.2 Program SAP images With Shared Serialization

The Cyclone screen in **Figure 13-8** shows two SAP images stored on the Cyclone: The first is 'Waynes SAP Image Serialx2' and the second is 'Garths SAP Image Serialx2'. They both use the same serial file named 'PEserial K64 Count by 2' which has a unique ID *ser-4FD596BF-7DDD6470-5BDAE9E7* and the next serial number to be programmed (in ASCII) is PE-002. If we select Waynes SAP image we can see this current PE-002.

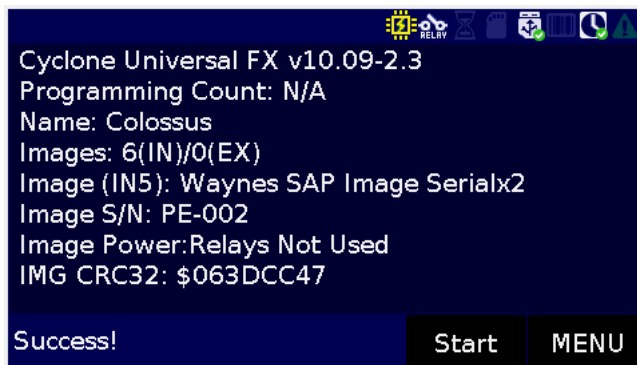

Figure 12-8: View Current Serial Number for "Wayne's SAP Image"

Once programmed is initiated, PE-002 is programmed into memory and the screen shows the next serial number to be programmed is which is PE-004.

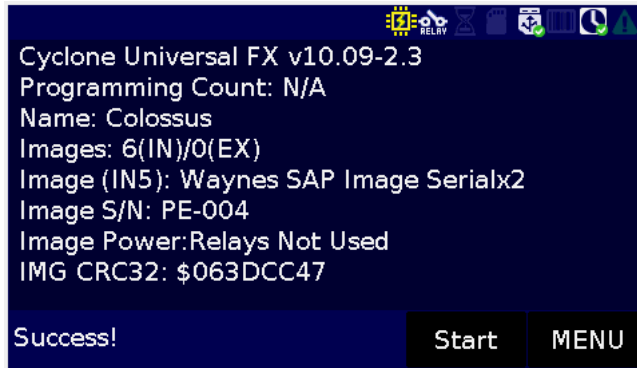

Figure 12-9: Serial Number Incremented for "Wayne's SAP Image"

If the Garth's SAP Image is now selected on the Cyclone, it will show the next serial number to be programmed is PE-004 because it tracks the same serial number.

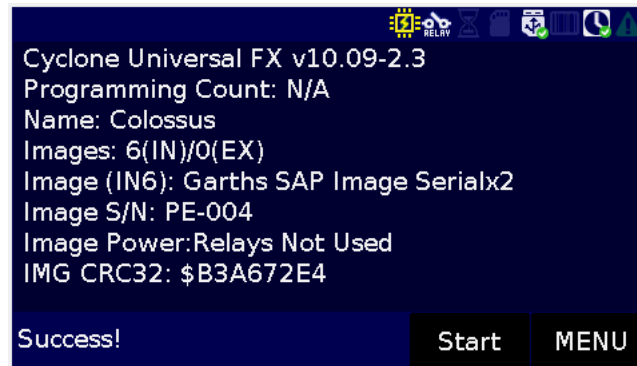

Figure 12-10: Serial Number Also Incremented for "Garth's SAP Image"

13 CYCLONE LICENSE INSTALLATION

PEmicro's current-generation Cyclone LC programmers can have optional licenses installed into them: the SDHC Port Activation License, the ProCryption Security Activation License, and the Cyclone Control Suite Advanced Features License. Once a license is installed into the Cyclone, it will be available to the Cyclone even after it is reset and/or powered down. Having a license installed in the Cyclone is often advantageous since it moves with the Cyclone (if the Cyclone is moved from PC to PC).

13.1 How to Install Your License

Follow the steps below to install a license on your Cyclone LC programmer:

1. Make sure the Cyclone is powered and connected to the PC or PC's network (via USB, Ethernet, or Serial).
2. Open the Cyclone Control GUI and connect to the appropriate Cyclone.
3. Click the "License" tab in the Cyclone Control GUI.

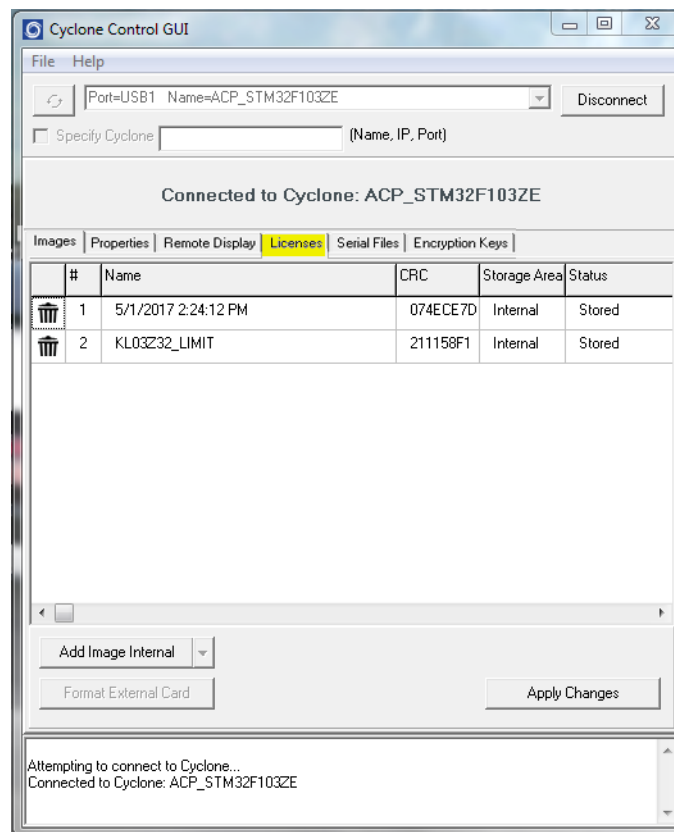

Figure 13-1: Cyclone Control GUI: License Tab

4. Click the “Add New License” button.

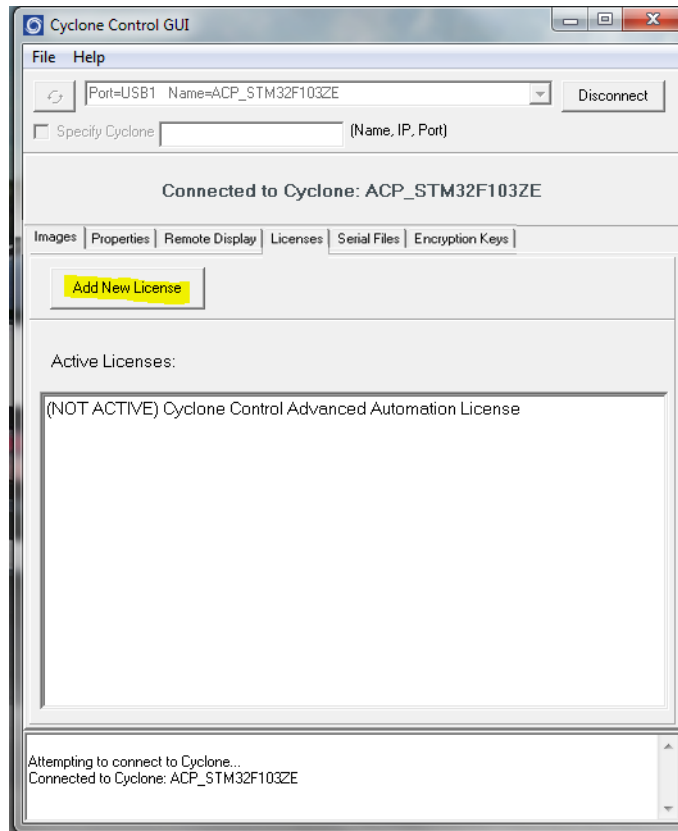

Figure 13-2: Add New License Button

5. A new window will pop-up and ask for you installation code. Add the Installation code for the license, which can be found on your invoice.

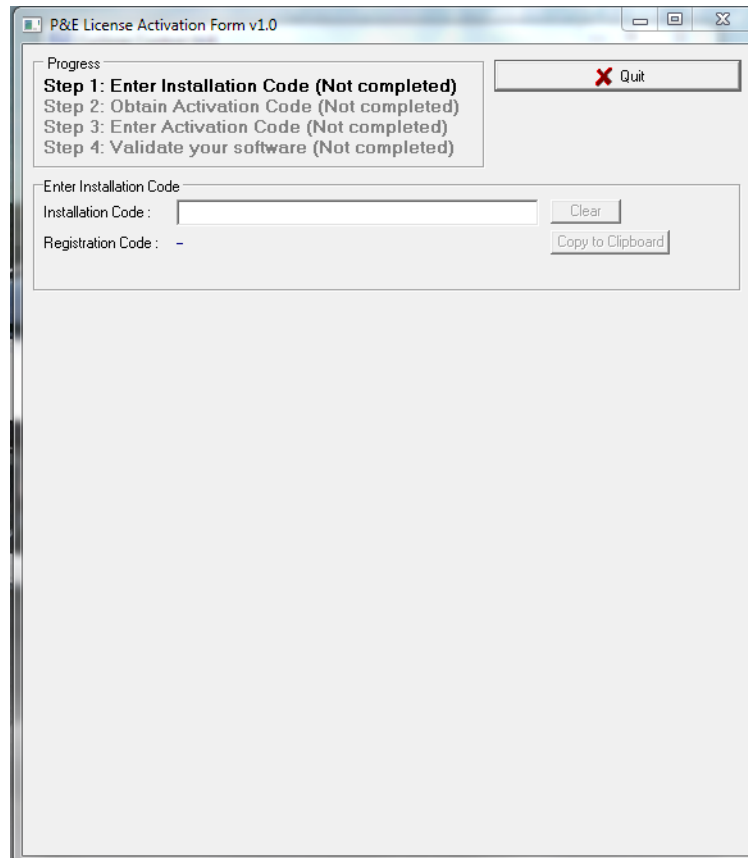

Figure 13-3: Add Installation Code For License

- Once you add your Installation code, the License Activation window will now tell you the several ways you can activate the license.

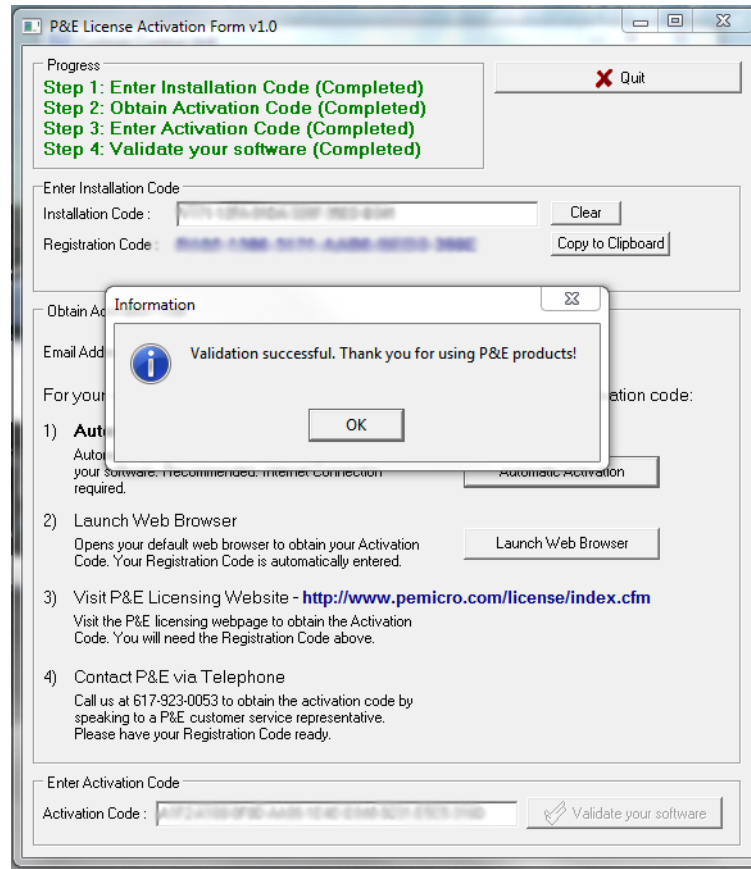

Figure 13-4: Activate License

When the activation process is complete, your license is stored in the Cyclone and ready for use.

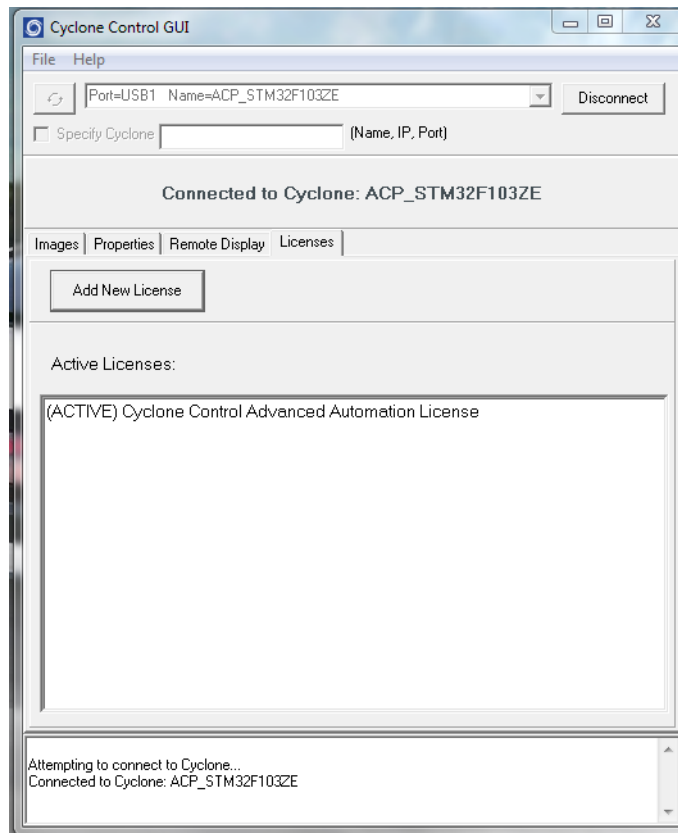

Figure 13-5: License Installed

14 TROUBLESHOOTING

This section answers some common questions that should help the user with various aspects of **Cyclone LC** operation.

14.1 My Cyclone Is Non-Responsive, Is There A Way To Re-Activate It?

It is possible that the issue is outdated firmware. In this case, you may wish to use **bootloader mode** to update the Cyclone firmware and then try to re-start the Cyclone.

14.1.1 What Is Bootloader Mode?

Bootloader Mode is a special running mode of the Cyclone Universal and Cyclone Universal FX in which only limited functionality of the Cyclone is allowed. In this mode, the Cyclone will allow communication to a PC via USB, Ethernet or serial ports. In Bootloader Mode the user can update the Cyclone firmware via the cyclone utilities.

The Bootloader screen will display the version of the bootloader, the version of the internal and external application, the name of the Cyclone and it's IP address.

14.1.2 When Is Bootloader Mode Used?

If the Cyclone ever becomes unresponsive, communication to the PC is not possible via USB, Ethernet, or Serial ports and if the cyclone fails to power on.

14.1.3 How Is Bootloader Mode Entered?

You can force the Cyclone into bootloader mode with the following sequence, with the Cyclone powered:

- Press the Reset button
- Press the Start button
- Release the Reset button
- Tap the Cyclone LCD screen 3 times
- Release the Start button

14.2 I Received A “SAP Image Needs To Be Updated” Error Using A Next-Gen Cyclone, How Do I Update?

The current PEmicro software that is available for all our Cyclones generates SAP images that are compatible with our newest generation of Cyclones.

However, customers who have generated SAP images using **older versions of our Cyclone software** with Cyclones such as the Cyclone PRO and Cyclone MAX, etc., will find that these SAP images will not work on the newer **Cyclone LC** and **Cyclone FX** programmers. Simply recreating these images for current generation Cyclones could potentially introduce errors and lose information about commands, settings, and configurations.

Therefore, we created the “SAP_Convert_Console.exe” which can be used to convert older generation SAP images into current generation SAP images. Once converted, an image will work not only on **Cyclone LC** and **Cyclone FX** programmers, but it will also remain compatible with the Cyclone for which it was originally created.

14.2.1 How Do I Use SAP_Convert_Console.exe?

SAP_Convert_Console.exe is a Windows command line utility and the software must be run through the Windows Command Prompt. The utility can be found in the same folder as the Cyclone's software install path.

The command line parameter syntax:

```
>SAP_Convert_Console [old_SAP_path] [new_SAP_path]
```

Where:

- [old_SAP_path]** The relative or full path to the SAP file. Usually has the .SAP file extension.
- [new_SAP_path]** Optional parameter where the user can specify a relative or full path to dump the output of the conversion. If path and file name matches the input, then the output file will replace the input file. If this parameter is not specified, the output will be dumped in the same path as the input file renamed with postfix “_2”. For example if the input is myfile.SAP, then the output will be myfile_2.SAP and will not replace the original input file.

14.3 When Trying To Install The CYCLONE Software, A Popup WDREG Error Occurs Telling Me That There Are Open Devices Using WinDriver.

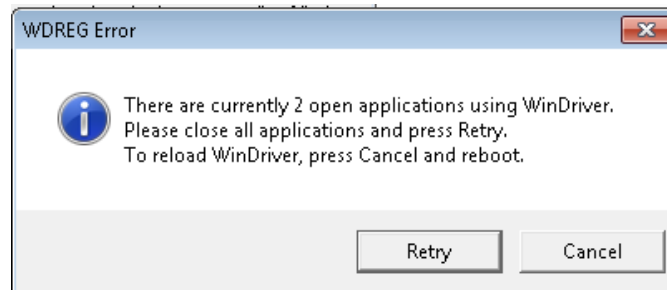

Figure 14-1: WDREG Error Message

The error is that the USB Driver (WinDriver) used by PE micro devices and software is currently in use and can't be upgraded as such. The simple solution is to shut down any PE micro software and also unplug any PE micro Cyclone, Multilink, and OpenSDA devices. If the error pops back up upon Retry, or you are remote from the machine itself, go to the Windows Device Manager and right click on each Multilink, Cyclone, and OpenSDA device and select “Disable”.

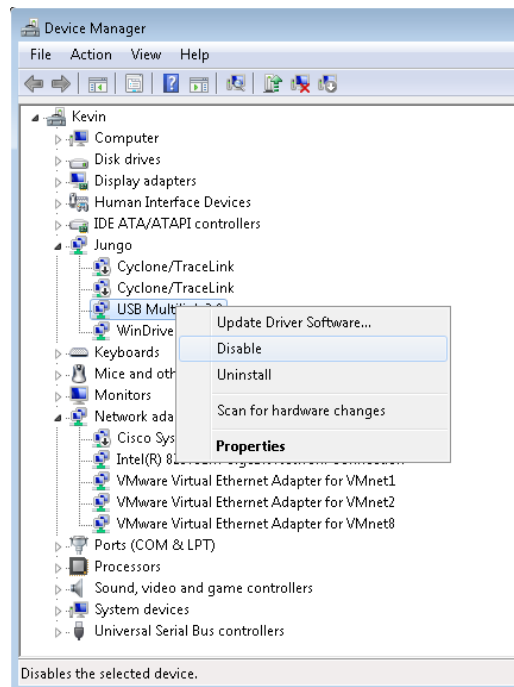

Figure 14-2: Disable Interfaces In Windows Device Manager

Upon clicking the Retry button in the installer, the drivers should now install and the devices will be automatically re-enabled.

15 ERROR CODES

The **Cyclone LC** will indicate errors using the following codes. Please contact PEmicro if instructed or if you are unsure of the specific meaning of an error code.

Note: Some code numbers in the sequence are skipped, these are old codes that have been removed.

15.1 Debug Mode Communication Related Errors

- \$0001: No target device response.
- \$0002: Invalid target device response.
- \$0003: Programming operation canceled.
- \$0004: Error while waiting for programming operation to complete.
- \$0005: Error attempting to detect the communication speed.
- \$0006: Error: Attempt to unsecure the device was unsuccessful.
- \$0007: An error occurred while entering debug mode.
- \$0008: Error entering debug mode. The device is secured.
- \$0009: Error entering debug mode for verification.
- \$000A: Error writing data to target.
- \$000B: Error enabling or disabling device for programming.
- \$000C: Error performing timing test.
- \$000E: Error: Vendor hardware is not supported.
- \$000F: Error generating VPP high voltage.

15.2 SAP Image Handling Related Errors

- \$0011: No image selected
- \$0012: Error validating image CRC
- \$0014: SAP image storage was not initialized
- \$0015: SAP image transfer error, odd length is not allowed
- \$0016: SAP image transfer error, invalid start address
- \$0017: SAP image transfer error while writing to storage
- \$0018: Error writing the serial number structure storage
- \$0019: Error writing the menu structure storage
- \$001A: Error erasing internal memory
- \$001B: Image requires higher firmware version
- \$001C: Image version is not supported. Please update firmware.
- \$001D: Out of RAM memory. Try reset Cyclone.
- \$001E: SAP image storage failure
- \$001F: Old SAP image format, not supported.
- \$0020: Programming image is not accessible.
- \$0021: Another image is being loaded. Do not interrupt.
- \$0022: Image already exists.
- \$0023: invalid Image ID. Image ID exceeds the maximum number of images allowed.
- \$0024: invalid Image ID. Image ID exceeds the total number of images available in the cyclone.
- \$0025: The ImageKey needed for decryption is not found on the Cyclone.
- \$0026: Image file can not be loaded.

15.3 SAP Communication Handling Related Errors

- \$0031: System reset occurred
- \$0032: System is busy with other operations.
- \$0033: System is busy with too many inquiries.
- \$0034: System has not finished initialization.

15.4 SAP Algorithm Header Operation Handling Related Errors

- \$0061: Undefined header operation
- \$0062: Operation in algorithm header has failed.

15.5 SAP Operation Related Errors

- \$0081: SAP operation is not supported.
- \$0082: Target type mismatch
- \$0083: SAP operation canceled
- \$0084: Running algorithm failure

15.6 SAP Blank Check Range and Module Related Errors

- \$1001: Blank Check is not supported by this algorithm.
- \$1002: Blank Check algorithm was not found.
- \$1003: Blank Check operation failed

15.7 SAP Erase Range and Module Related Errors

- \$2001: Erase error, algorithm not supported
- \$2002: Erase error, algorithm not found
- \$2003: Erase error, module failed or canceled
- \$2004: Erase error, module failed, target is still secured
- \$2005: Erase error, module not performed, data is preserved

15.8 SAP Program Byte, Word, and Module Related Errors

- \$3001: Program error, algorithm not supported
- \$3002: Program error, algorithm not found
- \$3003: Program operation failed or was canceled
- \$3004: Program operation failed, write protected
- \$3005: Program error, Data size exceeds the limit
- \$300A: Error during reading data range, invalid data length
- \$300B: Error during reading data range, invalid start address
- \$300C: Error during reading data range, no target power
- \$300D: Error during programming data range, invalid data length
- \$300E: Error during programming data range, invalid start address
- \$300F: Error during programming data range, no target power
- \$3010: Error reported while running the custom test application (RT) on the target.
- \$3011: Error displaying feature
- \$3012: Error programming feature
- \$3013: Error overlaying feature

- \$3014: Error: Run Test Operation terminated
- \$3015: Error: Run Test Operation over character limit 255
- \$3016: Error run test operation failed
- \$3017: Error: unable to allocated memory during run test.
- \$3018: Error: Dynamic operation failure. Algorithm is not loaded. Check image settings.
- \$3040: Error: Program may cause the device to be secured permanently

15.9 SAP Verify Checksum Related Errors

- \$4001: Verify Checksum not supported
- \$4002: VC failed, invalid algorithm was used
- \$4003: VC operation failed or was canceled
- \$4011: VV command not supported
- \$4012: VV failed, invalid algorithm was used
- \$4013: VV operation failed or was canceled

15.10 SAP Verify Range and Module Related Errors

- \$5003: Error during verifying module.

15.11 SAP User Function Related Errors

- \$6003: Error during user functions.

15.12 SAP Trim Related Errors

- \$7001: Program Trim operation is not supported
- \$7003: No target response during a Program Trim operation
- \$7004: Program Trim error. Trim value is not set
- \$7007: Program Trim error. Trim value failed
- \$7008: Trim error. Trim value read failed
- \$7009: Trim value invalid, value is \$00 or \$FF
- \$700A: Trim value is invalid. Trim value is already programmed.

15.13 Unrecoverable Fatal Errors

- \$8001: Fatal Error: please contact PEmicro.
- \$8002: Fatal Error: please contact PEmicro.
- \$8003: Fatal Error: please contact PEmicro.
- \$8004: Fatal Error: please contact PEmicro.
- \$8005: Fatal Error: please contact PEmicro.
- \$8006: Fatal Error: please contact PEmicro.
- \$8007: Fatal Error: please contact PEmicro.
- \$8008: Fatal Error: please contact PEmicro.
- \$8009: Fatal Error: please contact PEmicro.
- \$800A: Fatal Error: please contact PEmicro.
- \$800B: Fatal Error: please contact PEmicro.
- \$800C: Fatal Error: please contact PEmicro.
- \$800D: Fatal Error: please contact PEmicro.

\$800E: Fatal Error: please contact PEmicro.
\$800F: Fatal Error: please contact PEmicro.
\$8010: Fatal Error: please contact PEmicro.
\$8011: Fatal Error: please contact PEmicro.
\$8012: Fatal Error: please contact PEmicro.
\$8013: Fatal Error: please contact PEmicro.
\$8014: Fatal Error: please contact PEmicro.
\$8015: Fatal Error: please contact PEmicro.
\$8016: Fatal Error: please contact PEmicro.
\$8017: Fatal Error: please contact PEmicro.
\$8018: Fatal Error: please contact PEmicro.
\$8019: Fatal Error: please contact PEmicro.
\$801A: Fatal Error: please contact PEmicro.
\$801B: Fatal Error: please contact PEmicro.
\$801C: Fatal Error: please contact PEmicro.
\$8020: Fatal Error: please contact PEmicro.
\$8021: Fatal Error: please contact PEmicro.
\$8022: Fatal Error: please contact PEmicro.
\$8023: Fatal Error: please contact PEmicro.
\$8024: Fatal Error: please contact PEmicro.
\$8025: Fatal Error: please contact PEmicro.

15.14 Operation Security Related Errors

\$9001: Error: Exceeds image specified Program Limit
\$9002: Error: Exceeds image specified Error Limit
\$9003: Error: Exceeds Image specified Date Range
\$9004: Error: This programming image has usage restrictions enabled. A Cyclone ProCryption Security License is needed..
\$9005: Error: This programming image has barcode enabled. Requires Cyclone FX hardware.
\$9006: Error: This programming image has command RT Run Code in Test/Calibration Mode. Requires Cyclone FX hardware.
\$9007: Error: This programming image has command DF Display Feature Data. Requires Cyclone FX hardware.
\$9008: Error: This programming image has command PF Program Feature Data to Address.Requires Cyclone FX hardware.
\$9009: Error: This programming image has command OF Overlay Feature Data over File Data. Requires Cyclone FX hardware.
\$900A: Error: A Cyclone SDHC Port Activation License is needed before you can use an SD Card.

15.15 External Memory-Related Errors

\$A001: Error writing to external memory card
\$A002: Error formatting the external memory card
\$A003: External memory card was disconnected during use
\$A004: External memory card has unsupported format
\$A005: External memory card has corrupted data

\$A006: Faulty external memory card.

\$A007: Failed during internal memory verification

\$A008: Failed during external memory card verification

\$A009: Error while reading external memory card for image pointer

\$A00A: Error: Read-only lock is enabled in the external memory card.

15.16 Serial Number Related Errors

\$B001: Error erasing the serial number storage

\$B002: Error writing serial number

\$B003: Serial number is over the limit, up to 255 can be supported at a time

\$B004: Error loading Serial Number structure from reset

\$B005: Error during serial number structure update

\$B006: Error: Serial Number structure was not found.

\$B007: Error: Serial Number structure is invalid

\$B008: Error programming Serial Number to target.

\$B009: Error obtain Serial Number from storage.

15.17 Download Count Related Errors

\$C001: Error erasing the download counts storage

\$C002: Error writing the download counts

\$C003: Download counts is over the limit, up to 255 can be supported at a time

\$C004: Error trying to convert the download counts structure

15.18 System Hardware/Firmware/Logic Recoverable Errors

\$D001: Error: Firmware does not exist

\$D002: Error: Firmware update is not allowed

\$D003: Error: Firmware update has failed

\$D004: Error: There is a firmware mismatch during firmware update.

\$D005: Error: Voltage calibration failure.

\$D006: Error: Cannot either read or write disk

Cyclone LC vs. Cyclone FX Features		
	Cyclone LC	Cyclone FX
Support For Multiple Manufacturers & Architectures	<p>PEmicro-supported ARM Cortex devices (see pemicro.com/arm for complete list):</p> <ul style="list-style-type: none"> – Microchip (Atmel): SAMxxx – Cypress: PProC-BLE, PSoc4, PSoc5 – Infineon: XMC – NordicSemi: nRF51, nRF52 – NXP: Kinetis, LPC – OnBright: OB90Rxx – Silergy (Maxim): MAX716xx – Silicon Labs: EFM32, EFR32, SiM3 – STMicroelectronics: STM32 – Texas Instruments: LM3S, LM4, TM4C12x – Toshiba: TX00, TX03, & TX04 <p>Depending on the model, your Cyclone may also support these NXP 8-/16-/32-bit architectures (see Cyclone Models, below):</p> <ul style="list-style-type: none"> • S32 • ColdFire® V2/V3/V4 • ColdFire+/V1 • MPC5xx/8xx • Qorivva® (MPC5xxx) • DSC • ARM® Nexus (MAC7xxx) • S12Z • HC(S)12(X) • HCS08 • HC08 • RS08 • STMicroelectronics SPC5, STM8 	
Touchscreen Navigation & Control	Cyclone LC	Cyclone FX
	<ul style="list-style-type: none"> • 4.3" Touchscreen Display • Easily navigable LCD menu • Can be used to perform Stand-Alone Programming (SAP) operations 	

Cyclone LC vs. Cyclone FX Features		
	Cyclone LC	Cyclone FX
Extended Security Features	<ul style="list-style-type: none"> • Anti-tamper technology • Internal memory protection & encryption • ProCryption Security Activation License enables RSA/AES encryption and programming limits 	<ul style="list-style-type: none"> • Anti-tamper technology • Internal memory protection & encryption • RSA/AES encryption of programming images • Limit image programming to a date range • Limit # of programming operations
USB Expansion Port Functionality	-	<ul style="list-style-type: none"> • Barcode scanner can be used during programming process
On-Board Storage	16MB, up to 8 programming images	1GB, no practical limit to # of programming images
High-Speed Target Communications	Very fast	Extremely fast: Up to 75 Mb/s
Cyclone Models (PEmicro Part #)	<ul style="list-style-type: none"> • CYCLONE-LC-ARM: Supports a variety of ARM cortex MCU's • CYCLONE-LC-UNIVERSAL: Supports a variety of ARM cortex MCU's as well as STMicroelectronics SPC5, STM8, and NXP's Kinetis, LPC, S32, Qorivva (MPC5xxx), MPC5xx/8xx, DSC, S12Z, RS08, S08, HC08, HC(S)12(X), and ColdFire MCU's 	<ul style="list-style-type: none"> • CYCLONE-FX-ARM: Supports a variety of ARM cortex MCU's • CYCLONE-FX-UNIVERSAL: Supports a variety of ARM cortex MCU's as well as STMicroelectronics SPC5, STM8, and NXP's Kinetis, LPC, S32, Qorivva (MPC5xxx), MPC5xx/8xx, DSC, S12Z, RS08, S08, HC08, HC(S)12(X), and ColdFire MCU's
Powerful LCD Menu	<ul style="list-style-type: none"> • Executes SAP operations • Selects SAP image • Configures Cyclone IP settings • Displays operation status 	

Cyclone LC vs. Cyclone FX Features		
Multiple Communications Interfaces	Cyclone LC	Cyclone FX
	USB 2.0 Full Speed	USB 2.0 High-Speed
	<ul style="list-style-type: none"> • Ethernet: 10/100 baseT • Serial Baud 115200, no parity, 8 data bits, 1 stop bit (adjustable to 57600 Baud for RS232 controlled production environment) 	
Additional Storage - SDHC Memory Card Support	Cyclone LC	Cyclone FX
	<ul style="list-style-type: none"> • Available with SDHC Port Activation License 	<ul style="list-style-type: none"> • Via SDHC Port • SD Card can store more than 200 images.
Versatile Power Management	Cyclone LC	Cyclone FX
	<ul style="list-style-type: none"> • Uses electromechanical relays to automatically cycle target power when necessary. • Jumper-settable power management schemes. 	
Multiple Voltage Operation	Cyclone LC	Cyclone FX
	<ul style="list-style-type: none"> • Automatically detects and caters to target voltages ranging from 1.8V to 5V. 	
Multiple Target Communication Modes	Cyclone LC	Cyclone FX
	<ul style="list-style-type: none"> • Supports the following communications modes: <ul style="list-style-type: none"> – 6-Pin Regular Debug Connector BDM/JTAG Mode – 10-Pin Regular Debug Connector BDM/JTAG Mode – 14-Pin Regular Debug Connector Nexus/JTAG Mode – 16-Pin Regular Debug Connector MON08 Mode – 20-Pin Regular Debug Connector JTAG/SWD Mode – 26-Pin Regular Debug Connector BDM/ JTAG Mode – Mini 10-Pin Mini Debug Connector JTAG/SWD Mode – Mini 20-Pin Mini Debug Connector JTAG/SWD Mode • User-selectable target communication speed. 	
Multiple SAP Images	Cyclone LC	Cyclone FX
	<ul style="list-style-type: none"> • Onboard flash memory stores up to 8 images. • Images for different architectures can co-exist. 	
Multiple Memory Modules In One SAP Image	Cyclone LC	Cyclone FX
	<ul style="list-style-type: none"> • Supports multiple programming algorithms for internal or external memory modules such as EEPROM and Flash. 	

Cyclone LC vs. Cyclone FX Features		
Automatic Serial Number Mechanism	Cyclone LC	Cyclone FX
	<ul style="list-style-type: none"> • Supports serial number programming and automatic incrementing • Supports multiple serial number structures within each SAP Image. 	
Powerful Cyclone Control Suite for Production Control	Cyclone LC	Cyclone FX
	<p>Standard Features:</p> <ul style="list-style-type: none"> • Control a Cyclone via USB, Serial, or Ethernet connections • Select and Launch Images by Name or Enumeration • Recover programming result and descriptive error information • Use automatically counting local (Cyclone stored) serial numbers • Add/Remove/Update a single image in the Cyclone • Read/write Cyclone properties • Read Image and target Properties and Status <p>Advanced Cyclone Control Suite License available separately</p>	<p>Standard Features, Plus These Advanced Features:</p> <ul style="list-style-type: none"> • Add/Remove/Update many images in the Cyclone • Remote Display Access and the ability to “touch” the screen • Simultaneously (Gang) Control multiple Cyclones via the USB, Serial, or Ethernet connections • Program (and Read) Dynamic Data in addition to fixed image data
Versatile Programming Software	Cyclone LC	Cyclone FX
	<ul style="list-style-type: none"> • Free image creation utility, image management utility, and IP configuration utility 	
Convenient LED Display	Cyclone LC	Cyclone FX
	<ul style="list-style-type: none"> • Indicates success or failure 	
Real-Time Clock	Cyclone LC	Cyclone FX
	<ul style="list-style-type: none"> • System clock with battery backup, can be configured to display time and date on the main screen. • Time zone can be configured and time can be updated from the internet. 	
Production Environment Ready	Cyclone LC	Cyclone FX
	<ul style="list-style-type: none"> • Cyclones feature voltage protection technology. 	

17 TECHNICAL INFORMATION

This section contains information about various physical, mechanical, electrical, etc. aspects of the **Cyclone LC** programmers, part # CYCLONE-LC-ARM and part # CYCLONE-LC-UNIV. The information applies to both **Cyclone LC** part numbers unless specified.

17.1 Life Expectancy

Start Button: 1 Million Press Rated

17.2 Electrical Specifications

Input Voltage: DC 6V

Maximum Current: Up to 2A (0.6A typical) @ 6V

17.3 Mechanical Specifications

Dimensions: 8" L x 4" W x 1.25" H (20.3cm L x 10.2cm W x 3.2cm H)

Weight: 12.7 oz (360 g)

17.4 Electromechanical Relays

Max Recommended Switched Voltage: DC 24V

Max Recommended Switched Current: 1A

Output Voltage To Debug Port (when configured for internal power): DC 2V-5V

Max Current To Debug Port (when configured for internal power): 0.5 A

17.5 Debug Ports - CYCLONE-LC-ARM

Ports A, B: 0.05" (1.27 mm) Pitch

Ports C,,: 0.1" (2.54 mm) Pitch

Characteristic Impedance: 50 ohms (all ports)

17.6 Debug Ports - CYCLONE-LC-UNIV

Ports A, B: 0.05" (1.27 mm) Pitch

Ports C, D, E, F, G, H: 0.1" (2.54 mm) Pitch

Characteristic Impedance: 50 ohms (all ports)

17.7 International Shipping

HTS Number: 8471500150

ECCN: EAR99

17.8 Compliances/Standards

ROHS Compliant

CE Certified

FCC Certified

More information on PEmicro's Cyclone programmers is available at: pemicro.com/cyclone.