

Applications

- Military radar
- Civilian radar
- Professional and military radio communications
- Test instrumentation
- Wideband or narrowband amplifiers
- Jammers



Product Features

- Frequency: DC to 6 GHz
- Output Power (P_{3dB}): 10 W at 3.3 GHz
- Linear Gain: >17 dB at 3.3 GHz
- Operating Voltage: 28 V
- Low thermal resistance package

Functional Block Diagram

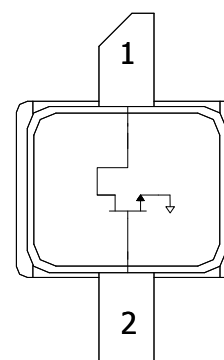

General Description

The TriQuint T2G6000528-Q3 is a 10W (P_{3dB}) discrete GaN on SiC HEMT which operates from DC to 6 GHz. The device is constructed with TriQuint's proven TQGaN25 production process, which features advanced field plate techniques to optimize power and efficiency at high drain bias operating conditions. This optimization can potentially lower system costs in terms of fewer amplifier line-ups and lower thermal management costs.

Lead-free and ROHS compliant

Evaluation boards are available upon request.

Pin Configuration

Pin No.	Label
1	V_D / RF OUT
2	V_G / RF IN
Flange	Source

Ordering Information

Part	ECCN	Description
T2G6000528-Q3	EAR99	Packaged part Flangeless
T2G6000528-Q3-EVB3	EAR99	3.0-3.5 GHz Evaluation Board
T2G6000528-Q3-EVB5	EAR99	3.8-4.2 GHz Evaluation Board
T2G6000528-Q3-EVB6	EAR99	5.8 GHz Evaluation Board
T2G6000528-Q3-EVB1	EAR99	1.9 – 2.7 GHz Evaluation Board

Absolute Maximum Ratings

Parameter	Value
Breakdown Voltage (V_{DGS})	100 V (Min.)
Drain Gate Voltage (V_{DG})	40 V
Gate Voltage Range (V_G)	-10 to 0 V
Drain Current (I_D)	2.5 A
Gate Current (I_G)	-2.5 to 7 mA
Power Dissipation (P_D)	15 W
RF Input Power, CW, $T = 25^\circ\text{C}$ (P_{IN})	34 dBm
Channel Temperature (T_{CH})	275 $^\circ\text{C}$
Mounting Temperature (30 Seconds)	320 $^\circ\text{C}$
Storage Temperature	-40 to 150 $^\circ\text{C}$

Operation of this device outside the parameter ranges given above may cause permanent damage. These are stress ratings only, and functional operation of the device at these conditions is not implied.

Recommended Operating Conditions

Parameter	Value
Drain Voltage (V_D)	28 V (Typ.)
Drain Quiescent Current (I_{DQ})	50 mA (Typ.)
Peak Drain Current (I_D)	650 mA (Typ.)
Gate Voltage (V_G)	-3.0 V (Typ.)
Channel Temperature (T_{CH})	225 $^\circ\text{C}$ (Max)
Power Dissipation, CW (P_D)	11 W (Max)
Power Dissipation, Pulse (P_D)	12.5 W (Max)

Electrical specifications are measured at specified test conditions. Specifications are not guaranteed over all recommended operating conditions.

RF Characterization – Load Pull Performance at 3.0 GHz ⁽¹⁾

Test conditions unless otherwise noted: $T_A = 25^\circ\text{C}$, $V_D = 28\text{ V}$, $I_{DQ} = 50\text{ mA}$

Symbol	Parameter	Min	Typical	Max	Units
G_{LIN}	Linear Gain		18.5		dB
P_{3dB}	Output Power at 3 dB Gain Compression		9.2		W
DE_{3dB}	Drain Efficiency at 3 dB Gain Compression		57.5		%
PAE_{3dB}	Power-Added Efficiency at 3 dB Gain		55.9		%
G_{3dB}	Gain at 3 dB Compression		15.5		dB

Notes:

- $V_{DS} = 28\text{ V}$, $I_{DQ} = 50\text{ mA}$; Pulse: 100 μs , 20%

RF Characterization – Load Pull Performance at 6.0 GHz ⁽¹⁾

Test conditions unless otherwise noted: $T_A = 25^\circ\text{C}$, $V_D = 28\text{ V}$, $I_{DQ} = 50\text{ mA}$

Symbol	Parameter	Min	Typical	Max	Units
G_{LIN}	Linear Gain		15.0		dB
P_{3dB}	Output Power at 3 dB Gain Compression		9.3		W
DE_{3dB}	Drain Efficiency at 3 dB Gain Compression		63.0		%
PAE_{3dB}	Power-Added Efficiency at 3 dB Gain		59.0		%
G_{3dB}	Gain at 3 dB Compression		12.0		dB

Notes:

- $V_{DS} = 28\text{ V}$, $I_{DQ} = 50\text{ mA}$; Pulse: 100 μs , 20%

RF Characterization – Performance at 3.3 GHz ^(1, 2)

Test conditions unless otherwise noted: $T_A = 25\text{ }^\circ\text{C}$, $V_D = 28\text{ V}$, $I_{DQ} = 50\text{ mA}$

Symbol	Parameter	Min	Typical	Max	Units
G_{LIN}	Linear Gain	15.5	17.4		dB
P_{3dB}	Output Power at 3 dB Gain Compression	8.9	9.7		W
DE_{3dB}	Drain Efficiency at 3 dB Gain Compression	50.0	53.0		%
PAE_{3dB}	Power-Added Efficiency at 3 dB Gain	45.0	49.7		%
G_{3dB}	Gain at 3 dB Compression	12.5	14.4		dB

Notes:

- Performance at 3.3 GHz in the 3.0 to 3.5 GHz Evaluation Board
- $V_{DS} = 28\text{ V}$, $I_{DQ} = 50\text{ mA}$; Pulse: 100 μs , 20%

RF Characterization – Narrow Band Performance at 3.5 GHz ⁽¹⁾

Test conditions unless otherwise noted: $T_A = 25\text{ }^\circ\text{C}$, $V_D = 28\text{ V}$, $I_{DQ} = 50\text{ mA}$

Symbol	Parameter	Typical
VSWR	Impedance Mismatch Ruggedness	10:1

Notes:

- $V_{DS} = 28\text{ V}$, $I_{DQ} = 50\text{ mA}$, CW at P_{1dB}

Thermal and Reliability Information

Parameter	Test Conditions	Value	Units
Thermal Resistance (θ_{JC})	DC at 85 °C Case	12.4	°C/W
Channel Temperature (T_{CH})		225	°C

Notes:
 Thermal resistance measured to bottom of package, CW.

Median Lifetime

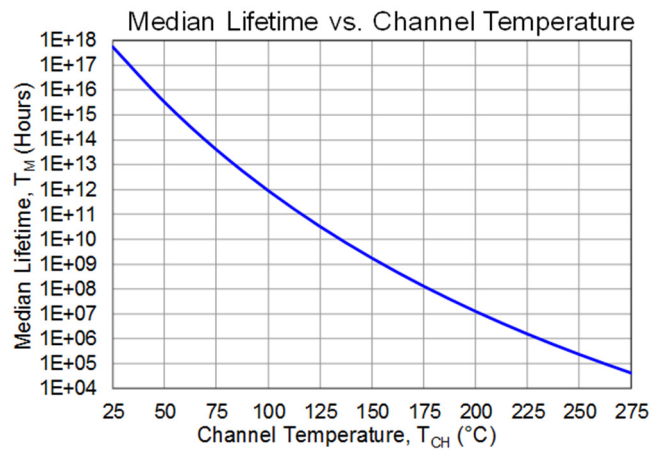

Maximum Channel Temperature

$T_{BASE} = 85^\circ\text{C}$, $P_D = 12.5\text{ W}$

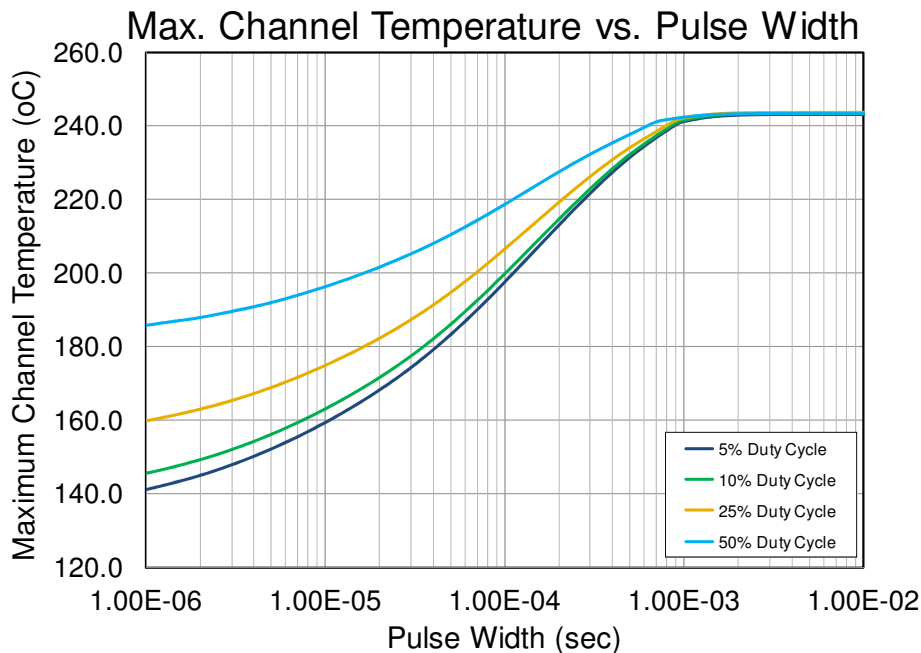

Load Pull Smith Charts (1, 2)

RF performance that the device typically exhibits when placed in the specified impedance environment. The impedances are not the impedances of the device, they are the impedances presented to the device via an RF circuit or load-pull system. The impedances listed follow an optimized trajectory to maintain high power and high efficiency.

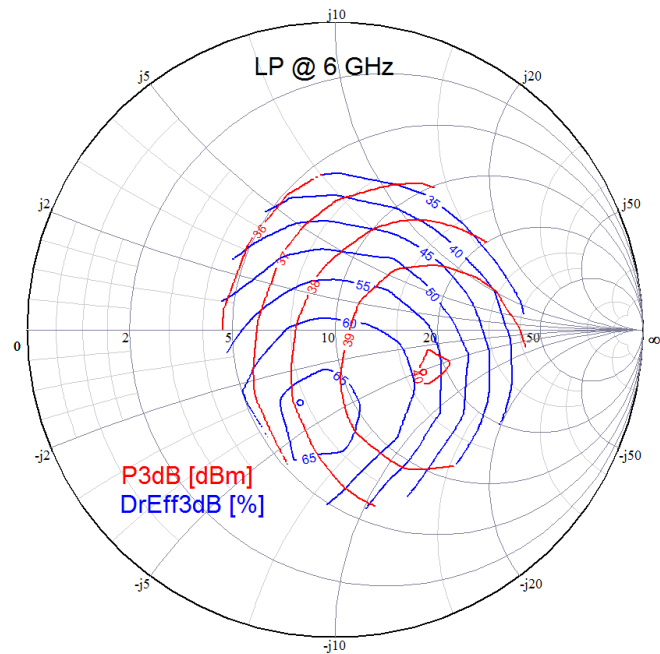
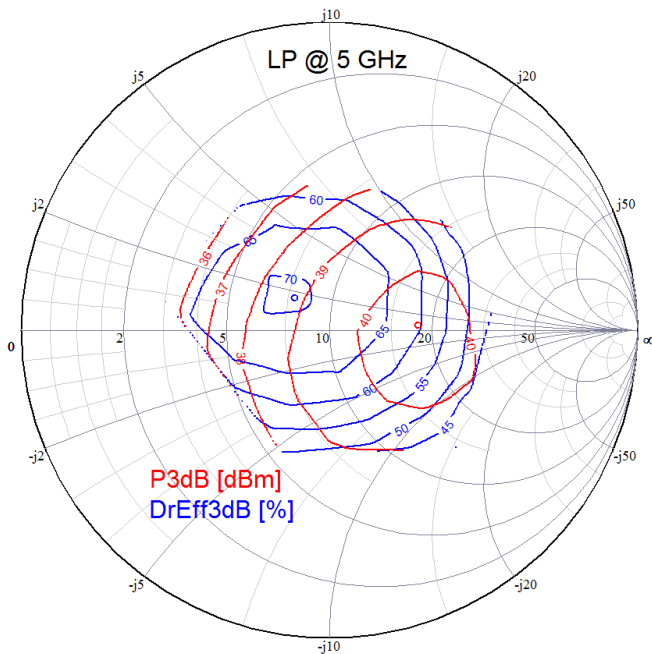
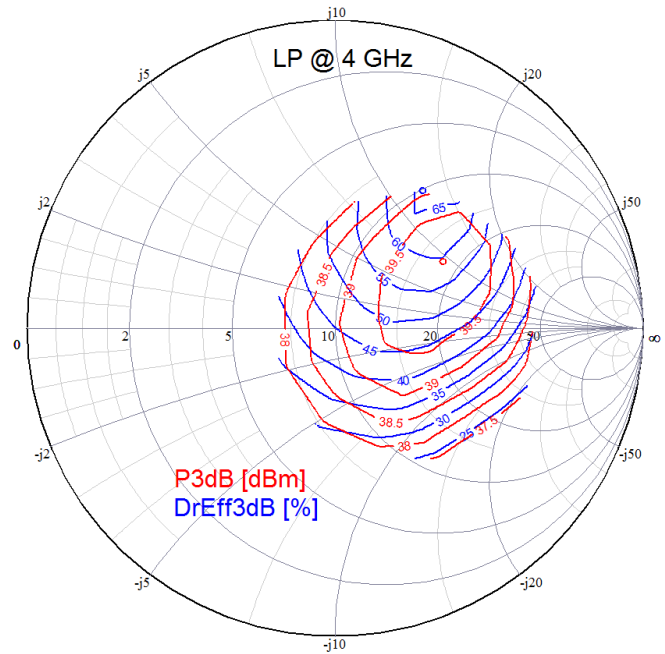
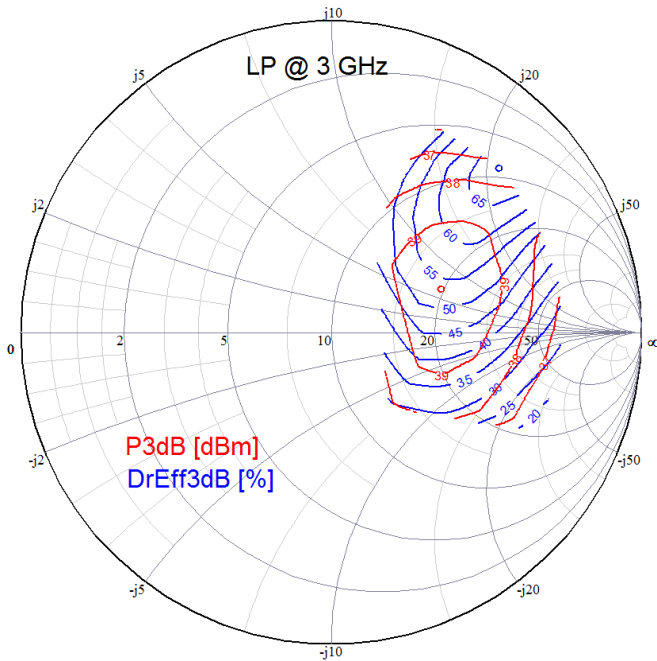

Notes:

1. Test Conditions: $V_{DS} = 28\text{ V}$, $I_{DQ} = 50\text{ mA}$
2. Test Signal: Pulse Width = 100 μsec , Duty Cycle = 20%

Typical Performance

Performance is based on compromised impedance point and measured at DUT reference plane.

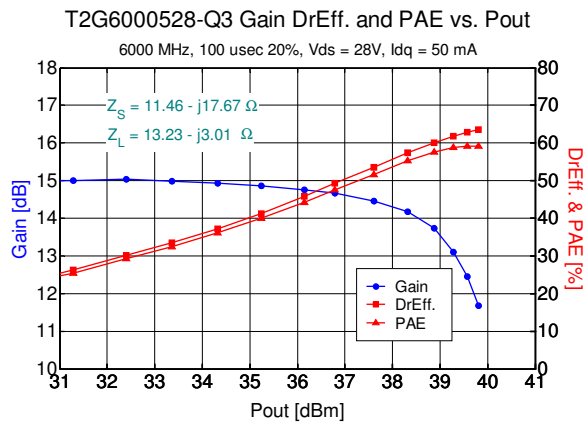
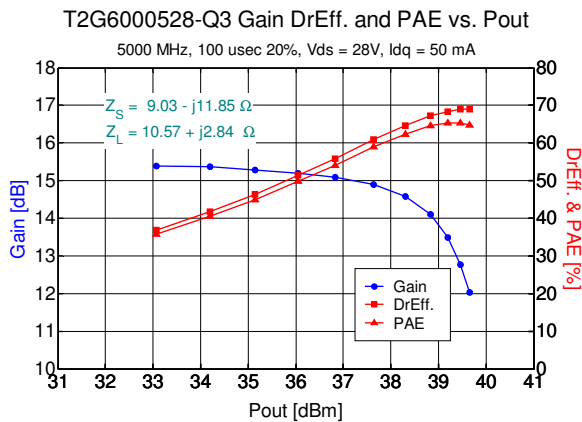
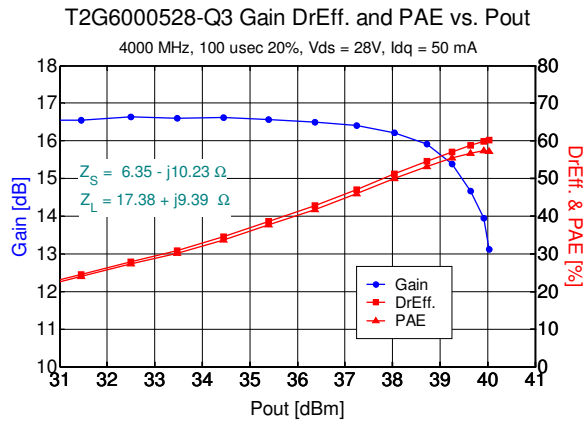
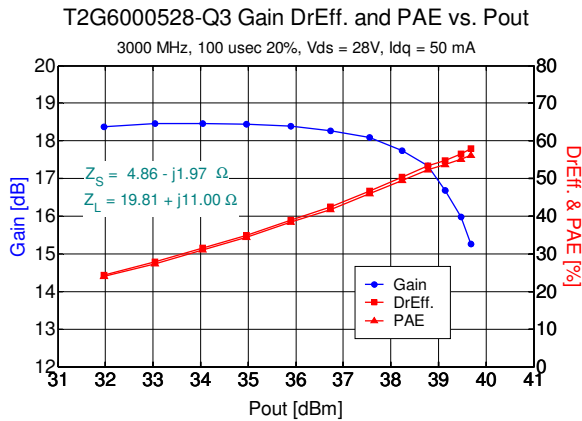
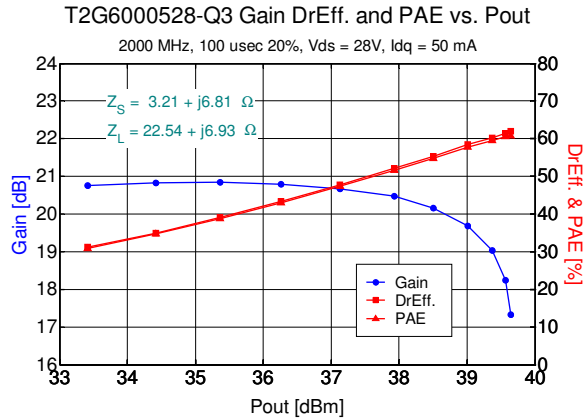
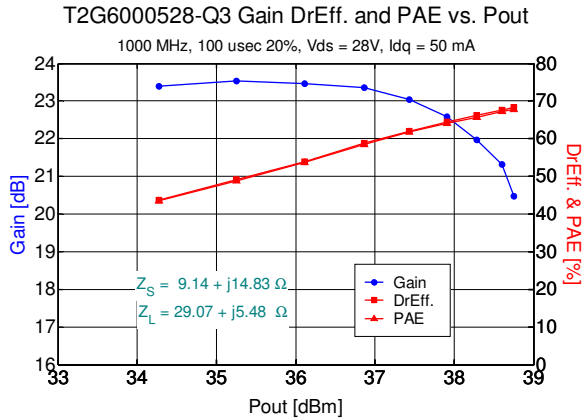

Performance Over Temperature (1, 2)

Performance measured in TriQuint's 3.0 GHz to 3.5 GHz Evaluation Board at 3 dB compression.

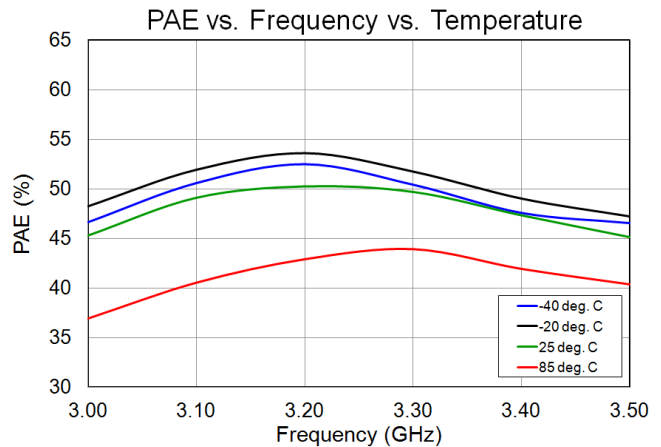
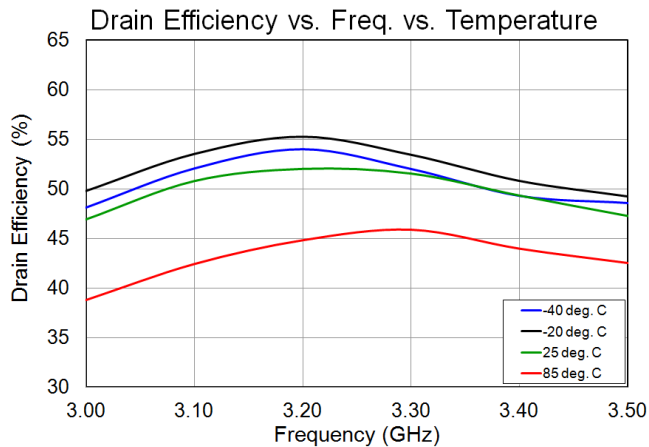
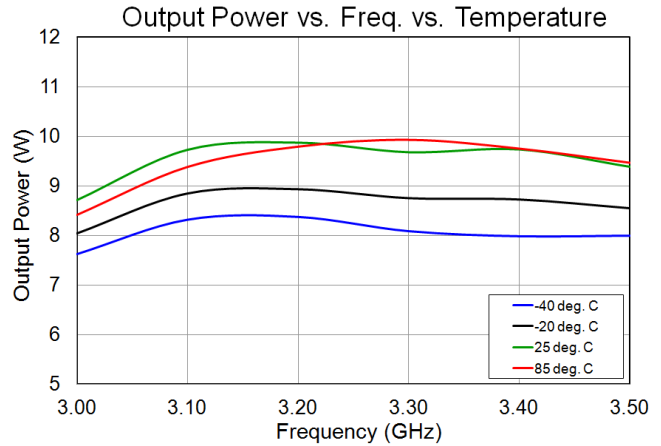
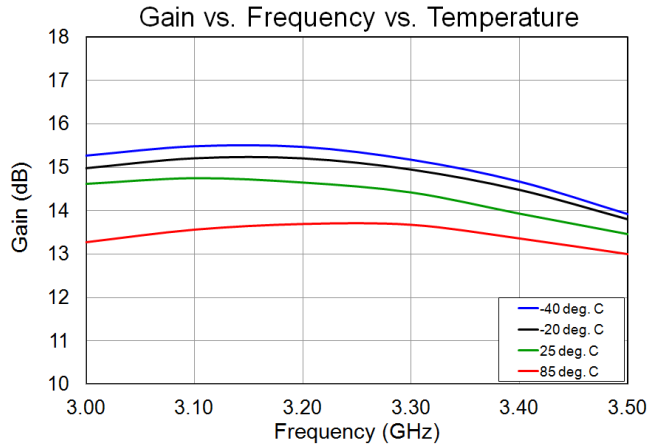

Notes:

1. Test Conditions: $V_{DS} = 28\text{ V}$, $I_{DQ} = 50\text{ mA}$
2. Test Signal: Pulse Width = 100 μs , Duty Cycle = 20%

Evaluation Board Performance (1, 2)

Performance at 3 dB Compression

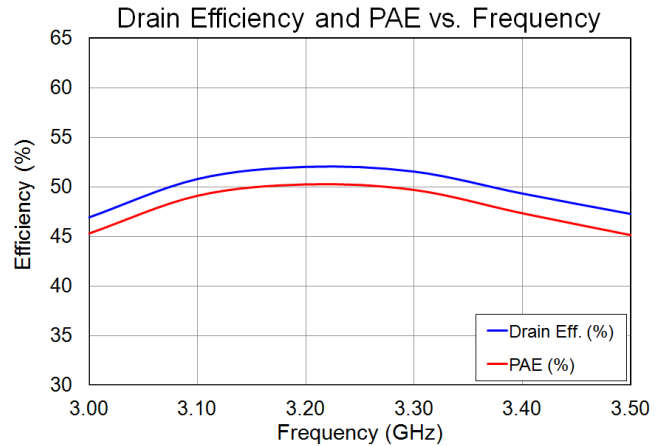
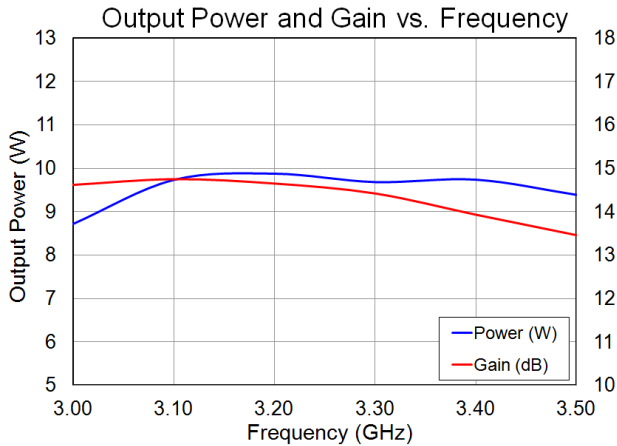

Notes:

1. Test Conditions: $V_{DS} = 28\text{ V}$, $I_{DQ} = 50\text{ mA}$
2. Test Signal: Pulse Width = $100\text{ }\mu\text{s}$, Duty Cycle = 20 %

Application Circuit

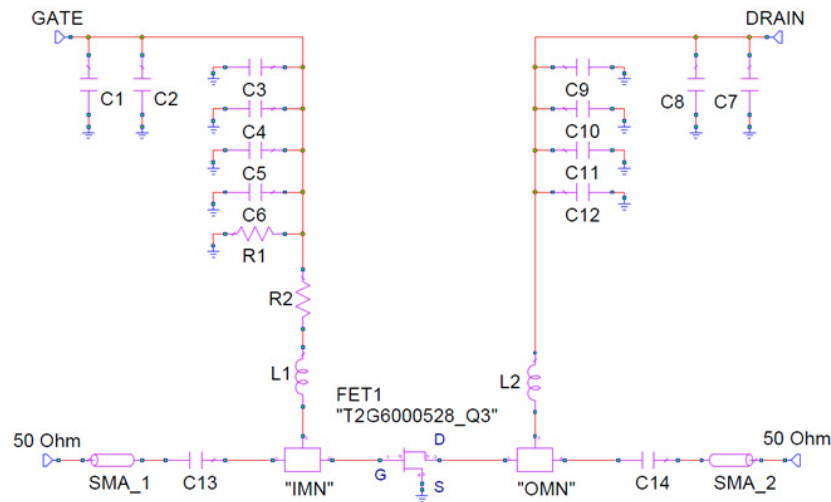

Bias-up Procedure

1. V_G set to -5 V.
2. V_D set to 28 V.
3. Adjust V_G more positive until quiescent I_D is 50 mA.
4. Apply RF signal.

Bias-down Procedure

1. Turn off RF signal.
2. Turn off V_D and wait 1 second to allow drain capacitor dissipation.
3. Turn off V_G .

Evaluation Board Layout

Top RF layer is 0.025" thick Rogers RO3210, $\epsilon_r = 10.2$. The pad pattern shown has been developed and tested for optimized assembly at TriQuint Semiconductor. The PCB land pattern has been developed to accommodate lead and package tolerances.

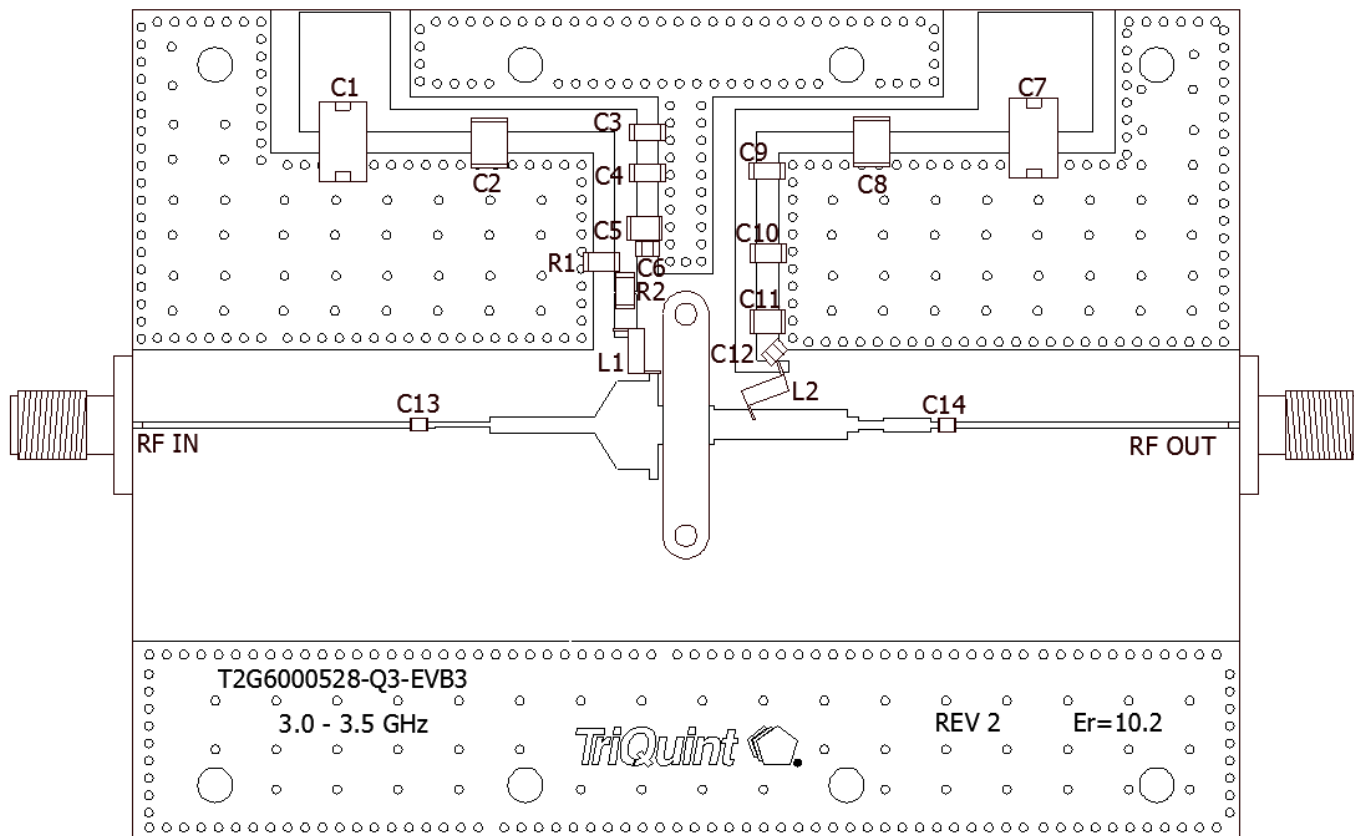

Bill of Materials

Reference Design	Value	Qty	Manufacturer	Part Number
C1, C7	22 uF	2	Sprague	T491D
C2, C8	1 uF	2	Kemet	1812C105KAT2A
C3, C9	0.1 uF	2	Kemet	C1206C104KRAC7800
C4, C10	0.01 uF	2	Kemet	C1206C103KRAC7800
C5, C11	100 pF	2	ATC	100B101
C6, C12	2400 pF	2	DLI	C08BL242C5UNC0B
C13, C14	27 pF	2	ATC	600L270JT200
R1	1000 ohm	1	Vishay Dale	CRCW0805100F100
R2	12 ohm	1	Vishay Dale	RM73B2B120J
L1, L2	9.85 nH	2	Coilcraft	16069JLB

Pin Layout

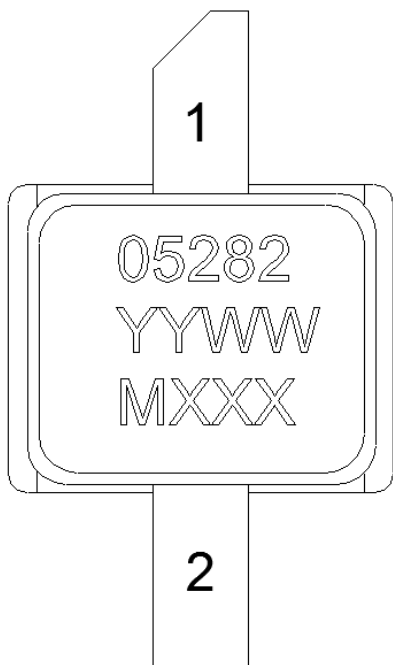

TOP VIEW

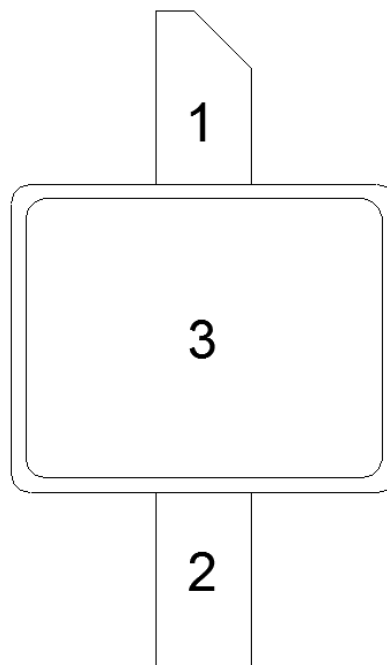

BOTTOM VIEW

Note:

The T2G6000528-Q3 will be marked with the “05282” designator and a lot code marked below the part designator. The “YY” represents the last two digits of the calendar year the part was manufactured, the “WW” is the work week of the assembly lot start, and the “MXXX” is the production lot number.

Pin Description

Pin	Symbol	Description
1	V_D / RF OUT	Drain voltage / RF Output matched to 50 ohms; see EVB Layout on page 9 as an example.
2	V_G / RF IN	Gate voltage / RF Input matched to 50 ohms; see EVB Layout on page 9 as an example.
3	Flange	Source connected to ground; see EVB Layout on page 9 as an example.

Notes:

Thermal resistance measured to bottom of package

Mechanical Information

All dimensions are in millimeters. Unless specified otherwise, tolerances are ± 0.127 .

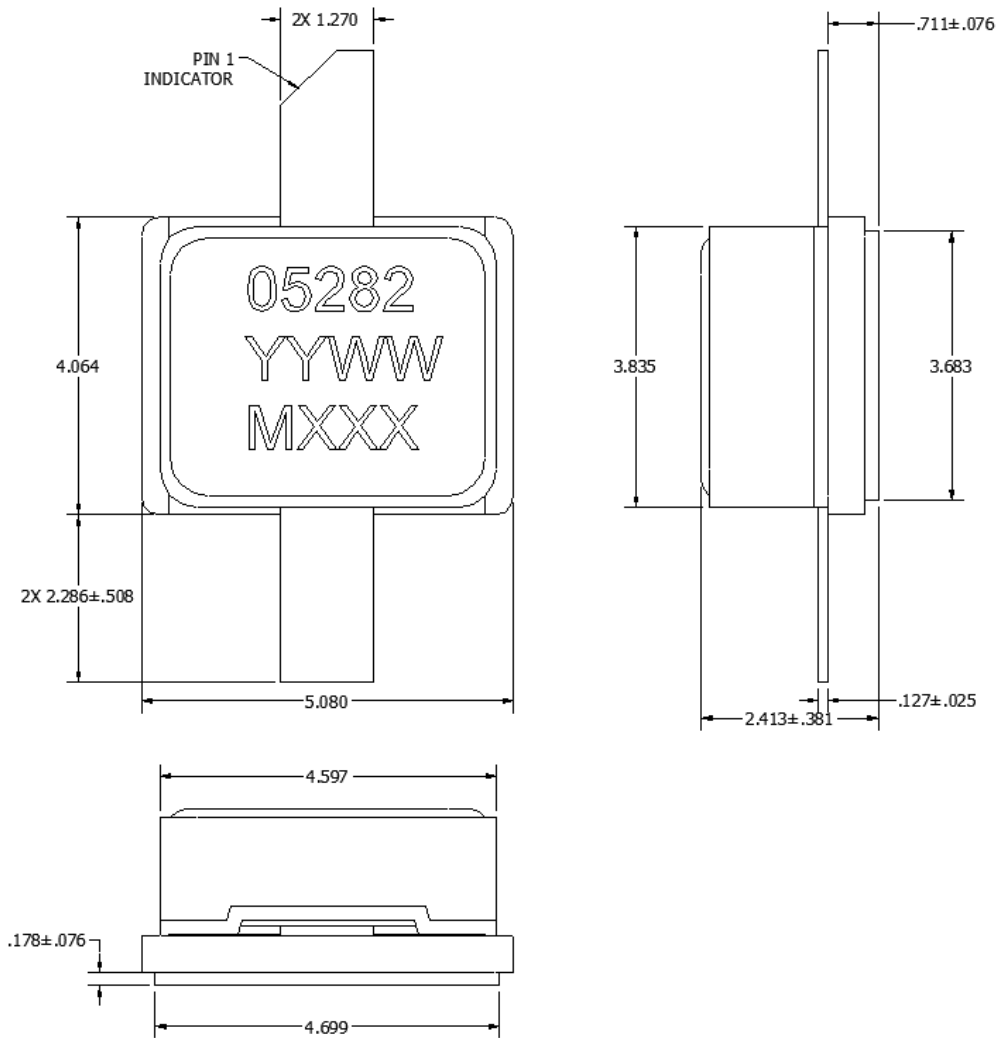

Note:

This package is lead-free/RoHS-compliant. The plating material on the leads is NiAu. It is compatible with both lead-free (maximum 260 °C reflow temperature) and tin-lead (maximum 245 °C reflow temperature) soldering processes.

Product Compliance Information

ESD Sensitivity Ratings



Caution! ESD-Sensitive Device

ESD Rating: Class 1A
 Value: Passes ≥ 250 V to < 500 V max.
 Test: Human Body Model (HBM)
 Standard: JEDEC Standard JESD22-A114

MSL Rating

Level 3 at $+260$ °C convection reflow
 The part is rated Moisture Sensitivity Level 3 at 260 °C per JEDEC standard IPC/JEDEC J-STD-020.

ECCN

US Department of Commerce EAR99

Solderability

Compatible with the latest version of J-STD-020, Lead free solder, 260 °C

RoHS Compliance

This part is compliant with EU 2002/95/EC RoHS directive (Restrictions on the Use of Certain Hazardous Substances in Electrical and Electronic Equipment).

This product also has the following attributes:

- Lead Free
- Halogen Free (Chlorine, Bromine)
- Antimony Free
- TBBP-A ($C_{15}H_{12}Br_4O_2$) Free
- PFOS Free
- SVHC Free

Recommended Soldering Temperature Profile

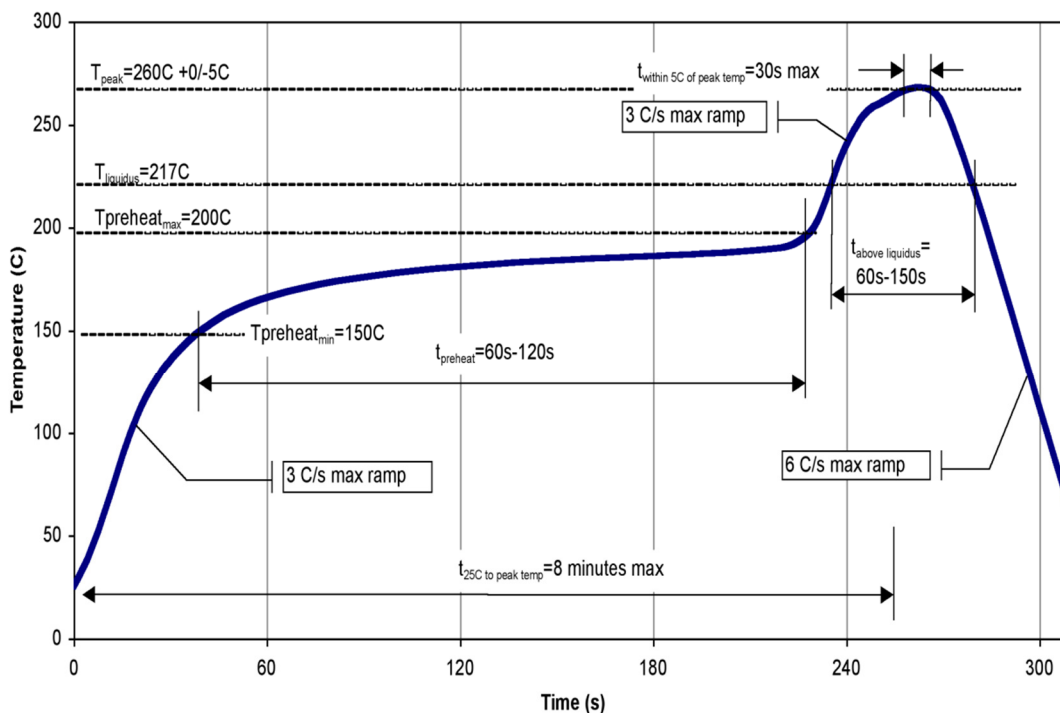

Contact Information

For the latest specifications, additional product information, worldwide sales and distribution locations, and information about TriQuint:

Web: www.triquint.com

Tel: +1.972.994.8465

Email: info-sales@triquint.com

Fax: +1.972.994.8504

For technical questions and application information:

Email: info-products@triquint.com

Important Notice

The information contained herein is believed to be reliable. TriQuint makes no warranties regarding the information contained herein. TriQuint assumes no responsibility or liability whatsoever for any of the information contained herein. TriQuint assumes no responsibility or liability whatsoever for the use of the information contained herein. The information contained herein is provided "AS IS, WHERE IS" and with all faults, and the entire risk associated with such information is entirely with the user. All information contained herein is subject to change without notice. Customers should obtain and verify the latest relevant information before placing orders for TriQuint products. The information contained herein or any use of such information does not grant, explicitly or implicitly, to any party any patent rights, licenses, or any other intellectual property rights, whether with regard to such information itself or anything described by such information.

TriQuint products are not warranted or authorized for use as critical components in medical, life-saving, or life-sustaining applications, or other applications where a failure would reasonably be expected to cause severe personal injury or death.