

Photomicrosensor (Transmissive) EE-SX398/498

 Be sure to read *Precautions* on page 25.

■ Dimensions

Note: All units are in millimeters unless otherwise indicated.

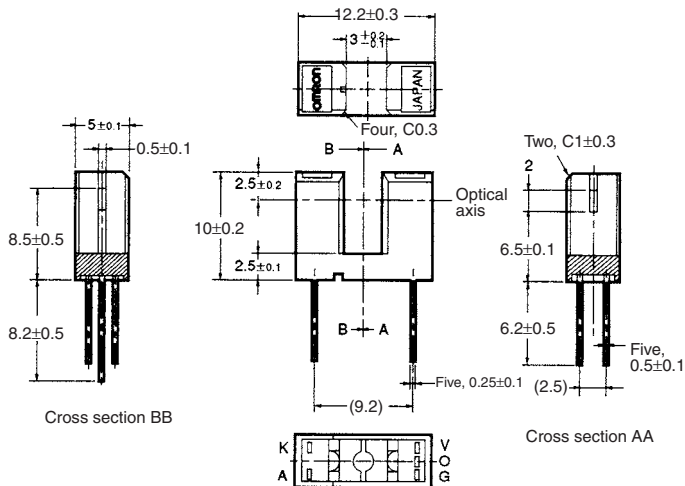

Internal Circuit

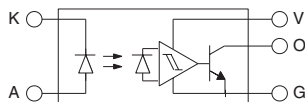

Unless otherwise specified, the tolerances are as shown below.

Terminal No.	Name
A	Anode
K	Cathode
V	Power supply (Vcc)
O	Output (OUT)
G	Ground (GND)

Dimensions	Tolerance
3 mm max.	±0.3
3 < mm ≤ 6	±0.375
6 < mm ≤ 10	±0.45
10 < mm ≤ 18	±0.55
18 < mm ≤ 30	±0.65

■ Features

- Incorporates an IC chip with a built-in detector element and amplifier.
- Incorporates a detector element with a built-in temperature compensation circuit.
- A wide supply voltage range: 4.5 to 16 VDC
- Directly connects with C-MOS and TTL.
- High resolution with a 0.5-mm-wide sensing aperture.
- Dark ON model (EE-SX398)
- Light ON model (EE-SX498)

■ Absolute Maximum Ratings (Ta = 25°C)

Item	Symbol	Rated value
Emitter	Forward current	I_F 50 mA (see note 1)
	Reverse voltage	V_R 4 V
Detector	Power supply voltage	V_{CC} 16 V
	Output voltage	V_{OUT} 28 V
	Output current	I_{OUT} 16 mA
	Permissible output dissipation	P_{OUT} 250 mW (see note 1)
Ambient temperature	Operating	T_{opr} -40°C to 75°C
	Storage	T_{stg} -40°C to 85°C
Soldering temperature	T_{sol}	260°C (see note 2)

- Note:** 1. Refer to the temperature rating chart if the ambient temperature exceeds 25°C.
2. Complete soldering within 10 seconds.

■ Electrical and Optical Characteristics (Ta = 25°C)

Item	Symbol	Value	Condition
Emitter	Forward voltage	V_F 1.2 V typ., 1.5 V max.	$I_F = 20$ mA
	Reverse current	I_R 0.01 μ A typ., 10 μ A max.	$V_R = 4$ V
	Peak emission wavelength	λ_P 940 nm typ.	$I_F = 20$ mA
Detector	Low-level output voltage	V_{OL} 0.12 V typ., 0.4 V max.	$V_{CC} = 4.5$ to 16 V, $I_{OL} = 16$ mA, $I_F = 0$ mA (EE-SX398), $I_F = 5$ mA (EE-SX498)
	High-level output voltage	V_{OH} 15 V min.	$V_{CC} = 16$ V, $R_L = 1$ k Ω , $I_F = 5$ mA (EE-SX398), $I_F = 0$ mA (EE-SX498)
	Current consumption	I_{CC} 3.2 mA typ., 10 mA max.	$V_{CC} = 16$ V
	Peak spectral sensitivity wavelength	λ_P 870 nm typ.	$V_{CC} = 4.5$ to 16 V
LED current when output is OFF	I_{FT}	2 mA typ., 5 mA max.	$V_{CC} = 4.5$ to 16 V
LED current when output is ON			
Hysteresis	ΔH	15% typ.	$V_{CC} = 4.5$ to 16 V (see note 1)
Response frequency	f	3 kHz min.	$V_{CC} = 4.5$ to 16 V, $I_F = 15$ mA, $I_{OL} = 16$ mA (see note 2)
Response delay time	t_{PLH} (t_{PHL})	3 μ s typ.	$V_{CC} = 4.5$ to 16 V, $I_F = 15$ mA, $I_{OL} = 16$ mA (see note 3)
Response delay time	t_{PHL} (t_{PLH})	20 μ s typ.	$V_{CC} = 4.5$ to 16 V, $I_F = 15$ mA, $I_{OL} = 16$ mA (see note 3)

Note: 1. Hysteresis denotes the difference in forward LED current value, expressed in percentage, calculated from the respective forward LED currents when the photo IC in turned from ON to OFF and when the photo IC in turned from OFF to ON.

2. The value of the response frequency is measured by rotating the disk as shown below.

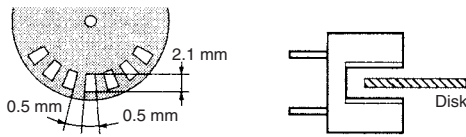

3. The following illustrations show the definition of response delay time. The value in the parentheses applies to the EE-SX498.

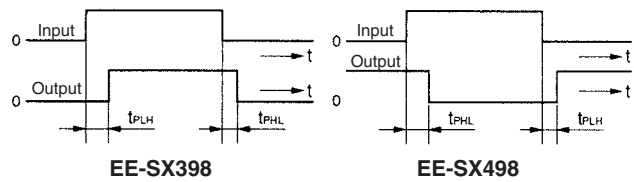

Engineering Data

Note: The values in the parentheses apply to the EE-SX498.

Forward Current vs. Collector Dissipation Temperature Rating

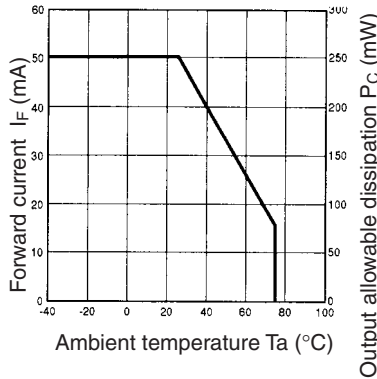

Forward Current vs. Forward Voltage Characteristics (Typical)

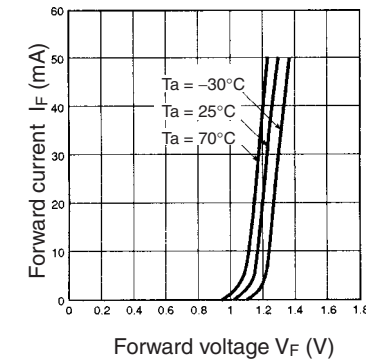

LED Current vs. Supply Voltage (Typical)

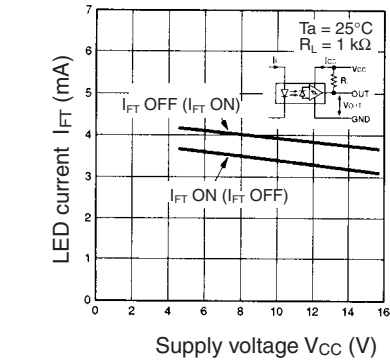

LED Current vs. Ambient Temperature Characteristics (Typical)

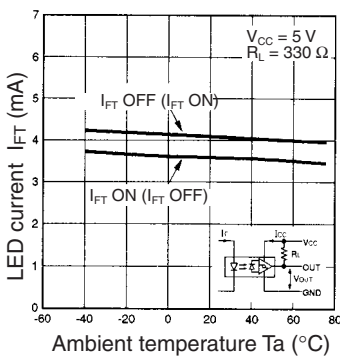

Low-level Output Voltage vs. Output Current (Typical)

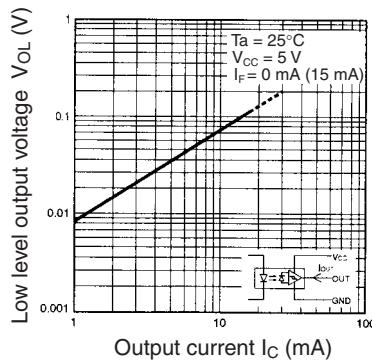

Low-level Output Voltage vs. Ambient Temperature Characteristics (Typical)

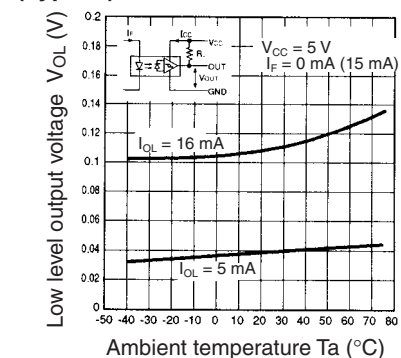

Current Consumption vs. Supply Voltage (Typical)

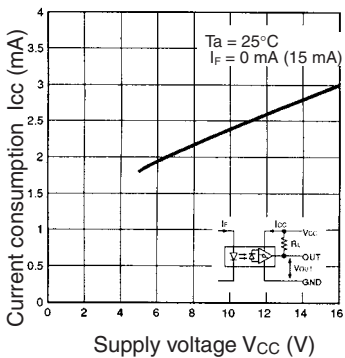

Response Delay Time vs. Forward Current (Typical)

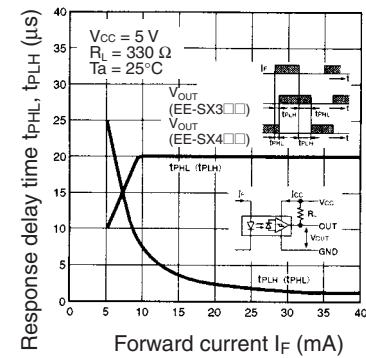

Repeat Sensing Position Characteristics (Typical)

