

10.7MHz INPUT FM IF DEMODULATOR

■ GENERAL DESCRIPTION

The **NJM2550** is a wide-operating voltage, low-current FM IF demodulator IC with 10.7MHz(standard) IF frequency. It includes a limiting amplifier, quadrature detector, filter amplifier, FSK/ASK(OOK) comparator, RSSI thermal characteristics correction, and quick charge circuit

The **NJM2550** is suitable for low power, narrow band receiver for short range data/voice transmission by using IF=10.7MHz or IF/carrier frequency of up to 50MHz.

■ PACKAGE OUTLINE

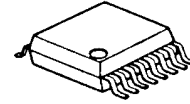

NJM2550V

■ FEATURES

- Wide Range Operating Voltage 2V to 9V
- Low Operating Current 4.4mA at $V^+ = 3V$
- Wide Range IF Input Frequency 10.7MHz (standard)
5MHz to 50MHz (reference value)
- Wide Band FM Detector Circuit 1MHz (reference value)
- High-speed Transmission Rate 2Mbps (reference value)
- FSK/ASK (OOS) Comparator
- Two External Resistors to Adjust RSSI 's Thermal Characteristics
- Bipolar Technology
- Package Outline SSOP16

■ BLOCK DIAGRAM

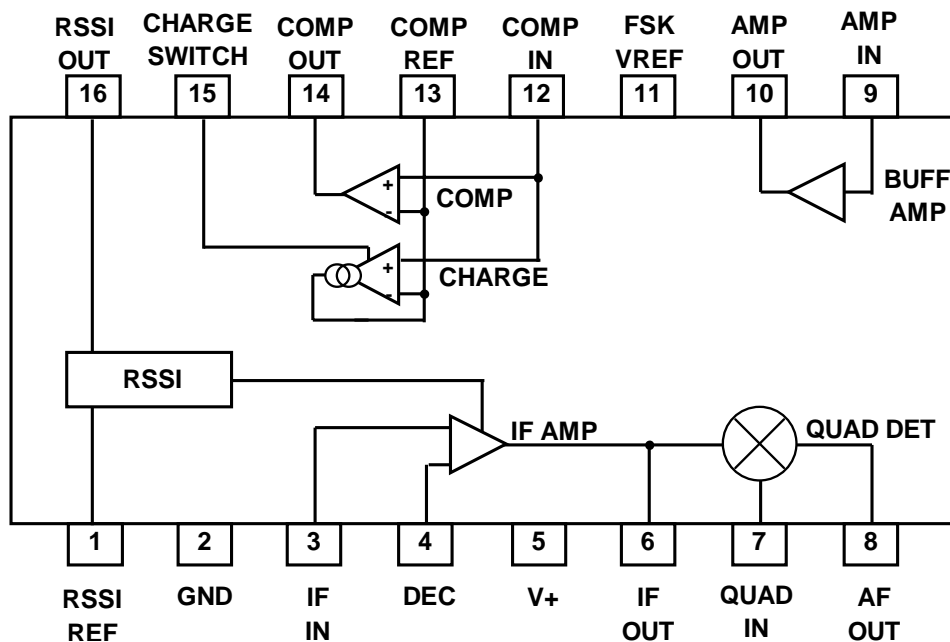

■ ABSOLUTE MAXIMUM RATINGS (Ta=25°C)

PARAMETER	SYMBOL	RATINGS	UNIT
Supply Voltage	V ⁺	10.0	V
Power Dissipation	P _D	300	mW
Operating Temperature	T _{opr}	- 40 to +85	°C
Storage Temperature	T _{stg}	- 40 to +125	°C

■ RECOMMENDED OPERATIONAL CONDITION (Ta=25°C)

PARAMETER	SYMBOL	TEST CONDITIONS	MIN.	TYP.	MAX.	UNIT
Supply Voltage	V ⁺		2.0	3.0	9.0	V

■ ELECTRICAL CHARACTERISTICS

(Ta=25°C, V⁺=3 V, f_{if}=10.7MHz, f_{mod}=1kHz, f_{dev}=±100kHz, unless otherwise noted)

PARAMETER	SYMBOL	TEST CONDITIONS	MIN.	TYP.	MAX.	UNIT
Current Consumption	I _{ccq}	No Signal V _{COMP REF} =0.6V V _{COMP IN} = 0.65V	-	4.4	5.8	mA
IF Amplifier Input Resistance	R _{in}		-	330	-	Ω
Signal to Noise Ratio 1	S/N1	V _{inIF} =80dBuV	-	60	-	dB
- 3dB Limiting Sensitivity	V _{in(lim)}	f _{if} = 10.7MHz	-	30	-	dBuV
		f _{if} = 50MHz	-	(40)	-	
Demodulated Signal Level	V _{od}	V _{inIF} =80dBuV	80	120	180	mVrms
Demodulated Signal Frequency Characteristics	f _{DET}	Based on f _{mod} =1kHz Measured at -3dB	-	1	-	MHz
Buffer Amplifier Gain	G _{amp}	1MHz	-1	0	1	dB
AM Rejection Ratio	AMR	V _{inIF} =80dBuV AM=30%	-	50	-	dB
Duty Ratio of Wave Shaped Output	DR	V _{inIF} =80dBuV	40	50	60	%
Quick Charge / Discharge Current	I _{ch}	V _{COMP REF} =GND V _{COMP IN} = 0.3V	120	210	300	uA
High Level Voltage of COMP OUT Terminal	V _{fskH}	1kΩ load	-	3	-	V
Low Level Voltage of COMP OUT Terminal	V _{fskL}	1kΩ load	-	0.1	-	V

The values shown in parenthesis are reference values.

PARAMETER	SYMBOL	TEST CONDITIONS	MIN.	TYP.	MAX.	UNIT
RSSI Dynamic Range	Δ RSSI		-	65	-	dB
Low Level Voltage of RSSI	VrssiL	No signal	-	100	-	mV
High Level Voltage of RSSI	VrssiH	VinIF=110dBuV	-	1.55	-	V
RSSI Output Voltage 1	Vrssi1	VinIF=80dBuV	-	1.2	-	V
RSSI Output Voltage 2	Vrssi2	f i f =50MHz, VinIF=80dBuV	-	1.15	-	V
1pin Terminal Voltage	V1p	33k Ω load	-	1.1	-	V

■ REFERENCE

(Ta=25°C, V⁺=3 V, f i f=10.7MHz, fmod=1kHz, fdev=±100kHz, unless otherwise noted)

PARAMETER	SYMBOL	TEST CONDITIONS	MIN.	TYP.	MAX.	UNIT
RSSI Output Signal Rise-up Time	-	V ⁺ =on IF Signal = off → on	-	50	-	usec
	-	IF Signal=on V ⁺ = off → on	-	600	-	usec
FM Demodulated Signal Rise-up Time	-	V ⁺ =on IF Signal = off → on	-	20	-	usec
	-	IF Signal=on V ⁺ = off → on	-	600	-	usec

■ TEST CIRCUIT

This test circuit allows the measurement of all parameters described in "ELECTRICAL CHARACTERISTICS". This test circuit includes an electrical switch that should be in the suitable position for the measurement of each parameter.

● Circuit Diagram

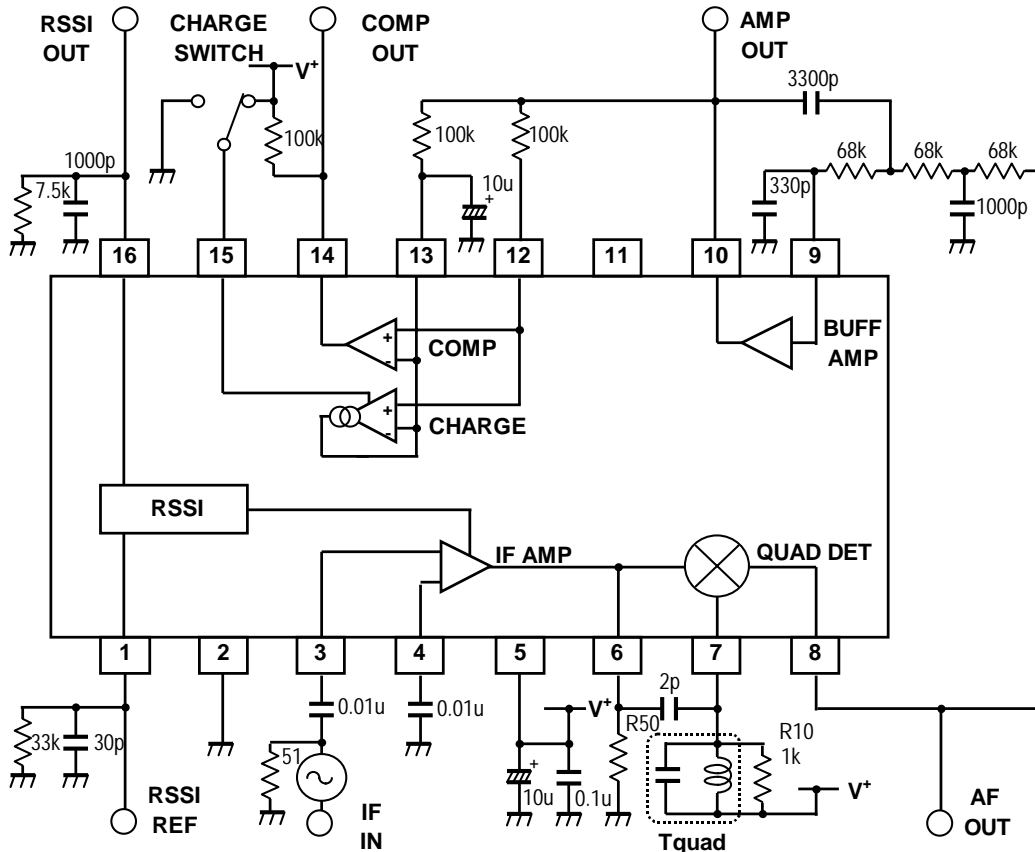

● External Components

- $f_{if} = 10.7 \text{ MHz}$
 - Tquad : IF transformer for detection, 4165-T070 (Sumida corporation)
 - R10 : $1 \text{ k}\Omega$
 - R50 : open
- $f_{if} = 50 \text{ MHz}$
 - Tquad : IF transformer for detection, 2261-T080 (Sumida corporation)
 - R10 : $1 \text{ k}\Omega$
 - R50 : $7.5 \text{ k}\Omega$
- The external resistors connected to 1pin and 16pin should have the same thermal coefficient.

■ TERMINAL FUNCTION (Ta=25°C, V+=3 V)

Pin No.	SYMBOL	EQUIVALENT CIRCUIT	VOLTAGE	FUNCTION
1	RSSI REF		1.12V	RSSI Reference Current Control To control RSSI reference current, a resistor is connected to pin1 and pin6, respectively. The recommended value is 33kΩ. By choosing the different thermal coefficient of these two resistors, RSSI thermal characteristics can be changed.
2	GND	--	--	Ground
3	IF IN		2.46	IF Limiter Amplifier Input The typical input impedance is 330Ω.
4	DEC		2.46V	IF Decoupling An external decoupling capacitor is connected to enhance stability.
5	V+		--	Supply Voltage
6	IF OUT		2.06V	IF Limiter Amplifier Output An external phase-shifting coil or discriminator is connected between pin6 and pin7.

Pin No.	SYMBOL	EQUIVALENT CIRCUIT	VOLTAGE	FUNCTION
7	QUAD IN		--	<p>Quadrature Detector Input An external phase-shifting coil or discriminator is connected between pin6 and pin7.</p> <p>Note that supply voltage should be the same as the voltage supplied to pin5.</p>
8	AF OUT		0.61V	<p>Demodulated Signal Output An external 3rd order multiple feedback filter(RC filter) is connected between pin8 and pin9.</p>
9	AMP IN		--	<p>Buffer Amplifier Input A set of external RC component forms a low pass filter between pin9 and pin10.</p>
10	AMP OUT		--	<p>Buffer Amplifier Output A set of external RC component forms a low pass filter between pin9 and pin10.</p>
11	FSK VREF		0.61V	<p>FSK Reference Voltage Output This pin usually keeps open. This fixed output voltage may be available for the FSK reference voltage by connecting to pin13. This usage is effective in shaping the data signal with continuous bits of the same polarity.</p> <p>Note that this usage is under consideration</p>

Pin No.	SYMBOL	EQUIVALENT CIRCUIT	VOLTAGE	FUNCTION
12	COMP IN		--	<p>Comparator Input This pin is an input of the wave shaping comparator.</p>
13	COMP REF		--	<p>Comparator Reference Input This pin is an input of reference voltage for the wave shaping comparator. A capacitor is connected to create an average DC Level of FM demodulated signal. The value of this capacitor is dependant on the speed of data signal. A quick charge /discharge circuit offers the voltage of pin13 comes the average DC Level of FM demodulated signal very quickly.</p>
14	COMP OUT		--	<p>Comparator Output An open-collector output. The comparator is non-reverse type. When the frequency of IF input signal is $f_{if} + \Delta$, the output is "Low". When the frequency of IF input signal is $f_{if} - \Delta$, the output is "High". Instead of V+, another power source can be used within the limit of the rated supply voltage.</p>
15	CHARGE SWITCH		--	<p>Quick Charge / Discharge Circuit ON / OFF Control The quick charge/discharge circuit is in the active stage when pin15 is pulled up to V+. This circuit is in the stand-by stage when pin15 is pulled down to GND. Instead of V+, another power source can be used within the limit of the rated power supply voltage.</p>

Pin No.	SYMBOL	EQUIVALENT CIRCUIT	VOLTAGE	FUNCTION
16	RSSI OUT		--	RSSI Output Pin16 outputs DC level proportional to the log of IF input signal level to pin3.

- Note :
 1. ESD protection diodes exist between each of the following pins and V⁺
Pin 1,3,4,6,8,9,10,11,16
 2. ESD protection diodes also exist between each of the following pins and ground.
Pin 1,3,4,6,7,8,9,10,11,12,13,14,15,16

■ EVALUATION BOARD

This evaluation board may be useful for your design and to have more understanding of the usage and performance of this device. The circuit diagram and test condition of this board is the same as TEST CIRCUIT. Note that this board is not prepared to show you the recommendation of pattern and parts layout.

● Circuit Diagram

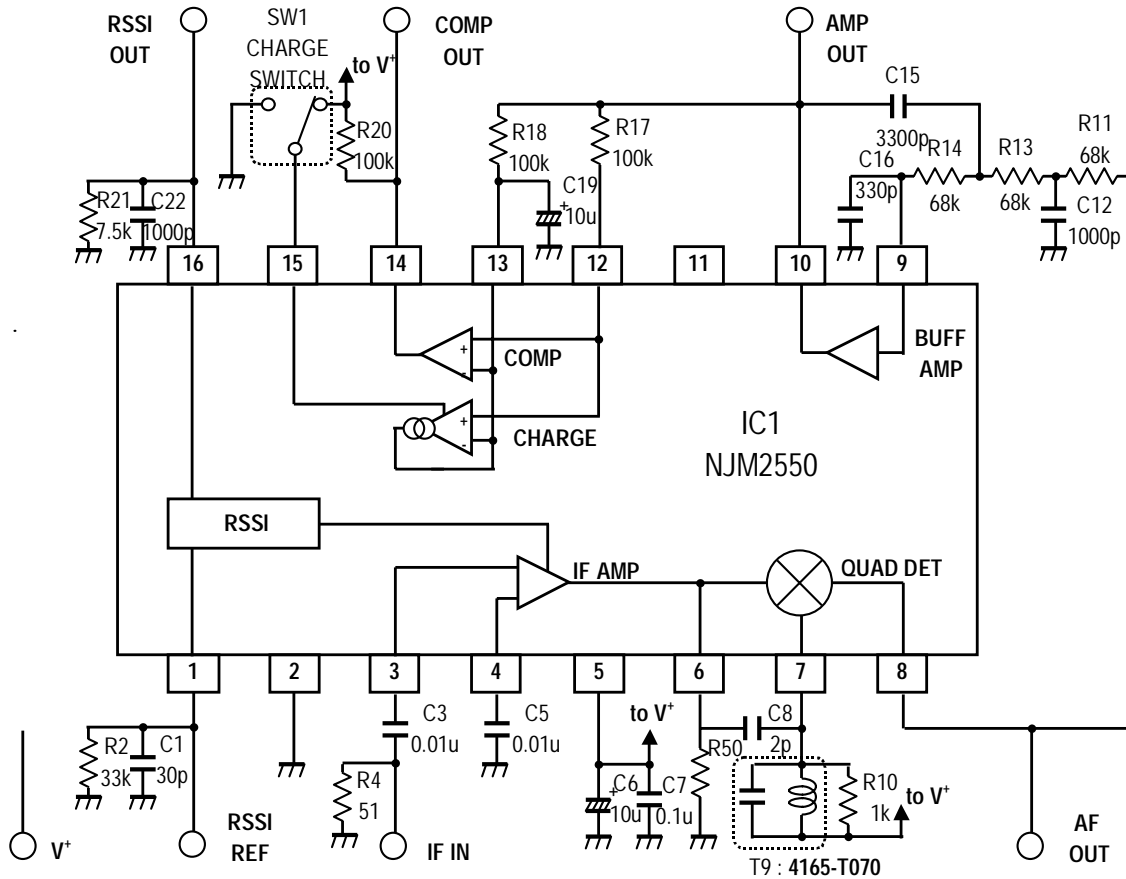

Note:

1. This board is designed for $f_{if}=10.7\text{MHz}$. For $f_{if}=50\text{MHz}$, please change T9, R10, and R50 as follows.

- $f_{if}=10.7\text{MHz}$ (factory-configured)
 - T9 : IF transformer for detection, 4165-T070 (Sumida corporation)
 - R10 : $1\text{k}\Omega$
 - R50 : open
- $f_{if}=50\text{MHz}$
 - T9 : IF transformer for detection, 2261-T080 (Sumida corporation)
 - R10 : $1\text{k}\Omega$
 - R50 : $7.5\text{k}\Omega$

2. This board is designed for $f_{dev}=\pm 100\text{kHz}$. For $f_{dev}=\pm 10\text{kHz}$, please refer to the values shown below.

- $f_{dev}=\pm 100\text{kHz}$ (factory-configured)
 - Tquad related values : $L=4400\text{nH}$, $Q=80$ $R_{quad}=1\text{k}\Omega$

- $f_{dev} = \pm 10\text{kHz}$
 Tquad related values : $L = 4400\text{nH}$, $Q = 110$ $R_{quad} = 30\text{k}\Omega$
3. The external resistors connected to 1pin and 16pin have the same thermal coefficient. By changing these thermal coefficients, RSSI thermal characteristics can be changed.
 4. This board is designed to supply voltage to CHARGE SWITCH, the pull-up of COMP OUT, and the quadrature circuit from the common power source. NJM2550 permits each of CHARGE SWITCH and pull-up of COMP OUT to have another power source within the limit of the rated power supply voltage. Note that the voltage supplied to the quadrature circuit should be the same as the voltage supplied to pin5.
 5. List of Components

Item	Number	value	Item	Number	value
Resistor	R2	33k	Capacitor	C1	30p
	R4	51		C3	0.01u
	R10	1k		C5	0.01u
	R11	68k		C6	10u
	R13	68k		C7	0.1u
	R14	68k		C8	2p
	R17	100k		C12	1000p
	R18	100k		C15	3300p
	R20	100k		C16	330p
	R21	7.5k		C19	10u
	R50	open	C11	1000p	
IC	IC1	NJM2550			
Switch	SW1	-----			
Transformer	T9	4165-T070			

● Pattern Layout

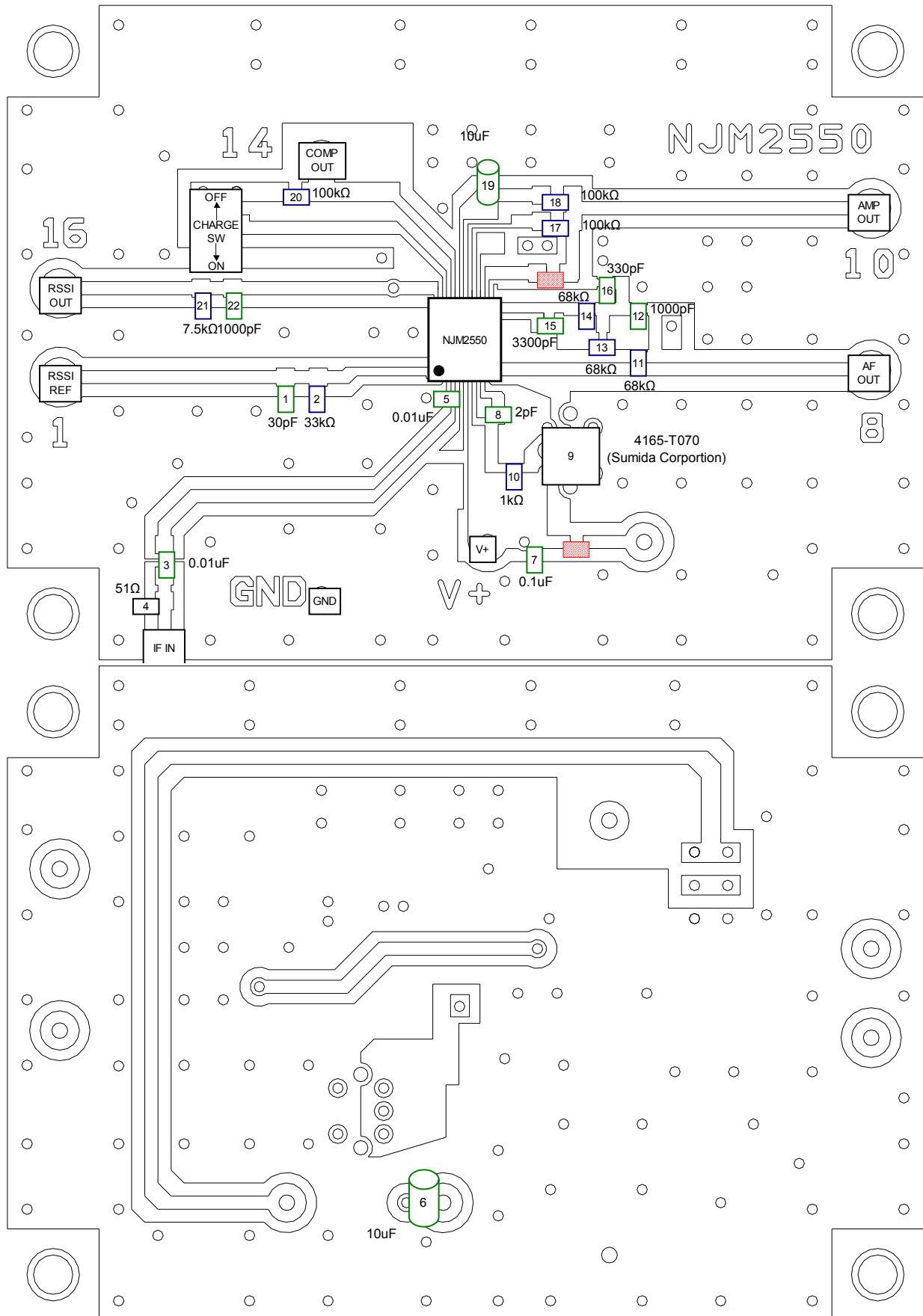

■ TYPICAL CHARACTERISTICS

Current Consumption versus Supply Voltage

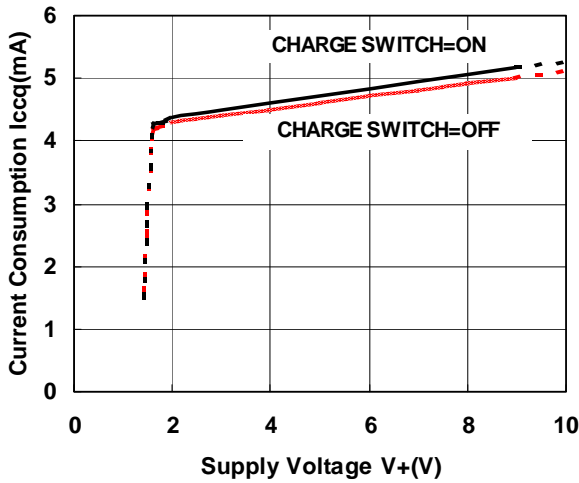

Demodulated Signal Level versus Supply Voltage

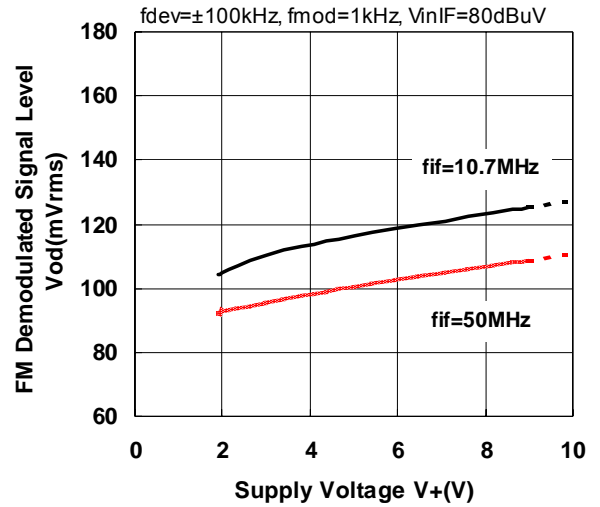

S/N versus Supply Voltage

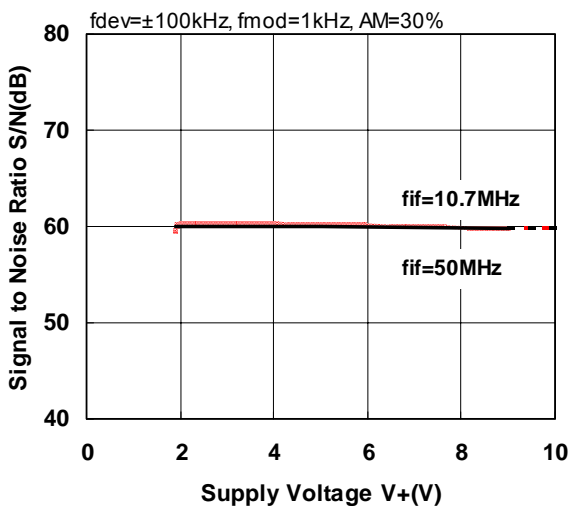

-3dB Limiting Sensitivity versus Supply Voltage

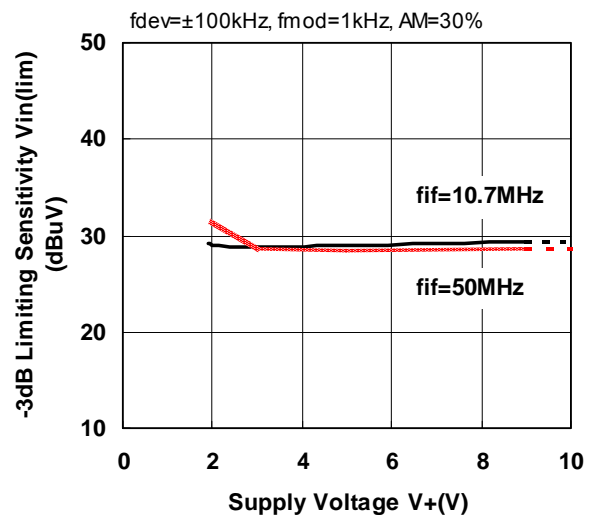

S+N,N,AMR versus IF Input Level-10.7MHz-

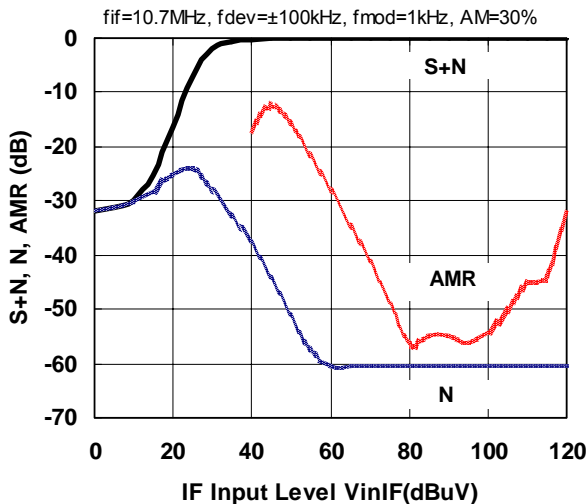

S+N,N,AMR versus IF Input Level-50MHz-

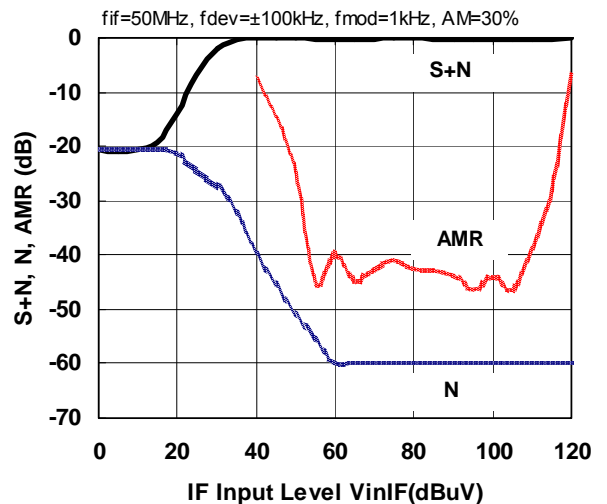

RSSI Output versus IF Input

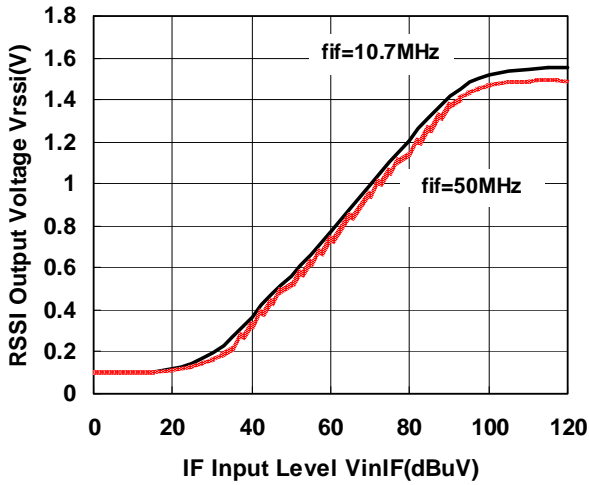

RSSI Output versus IF Frequency

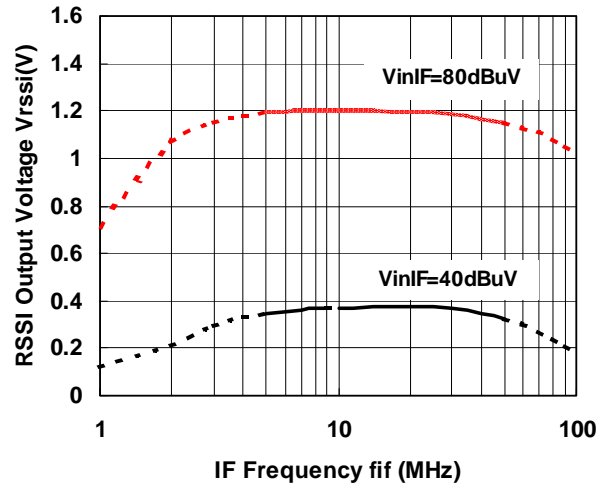

AF OUT versus IF Frequency(S Curve)-10.7MHz-

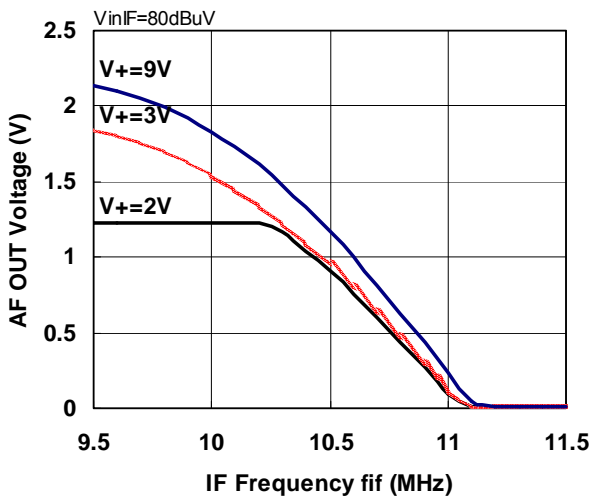

AF OUT versus IF Frequency(S Curve)-50MHz-

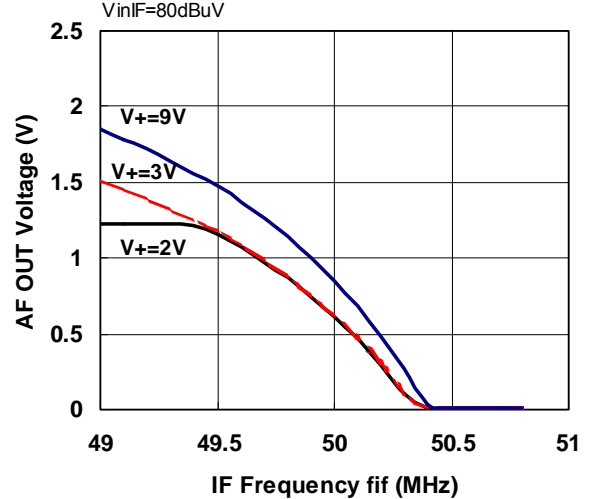

Demodulated Signal Frequency Characteristics

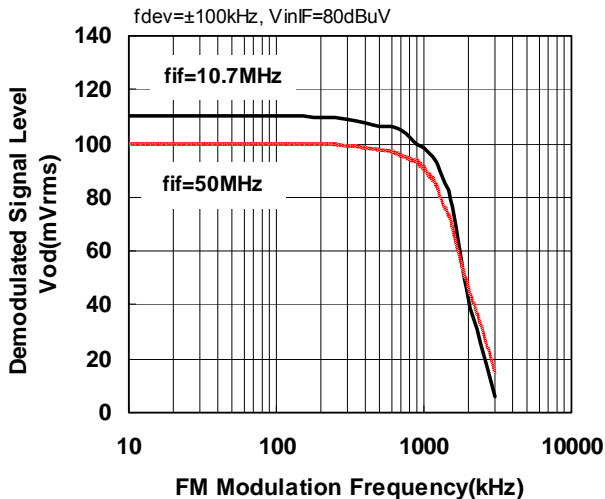

IF AMP Gain versus IF Frequency

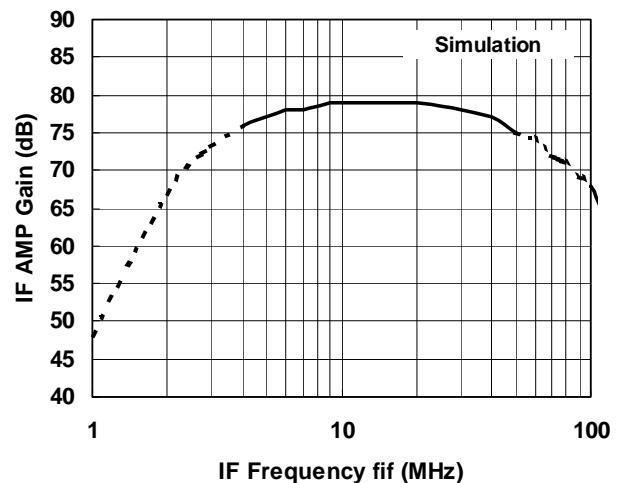

Current Consumption versus Temperature

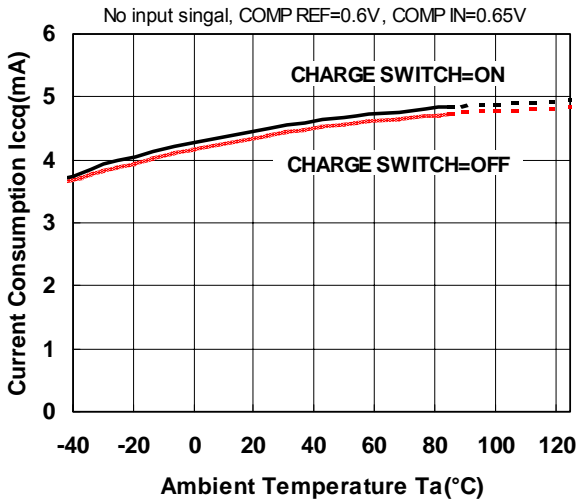

Demodulated Signal Level versus Temperature

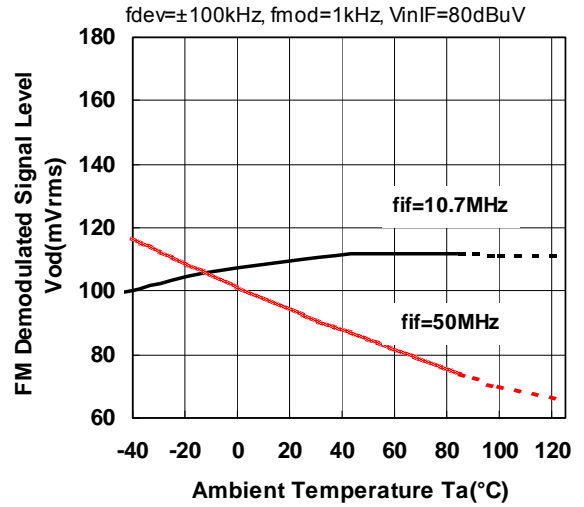

S/N versus Temperature

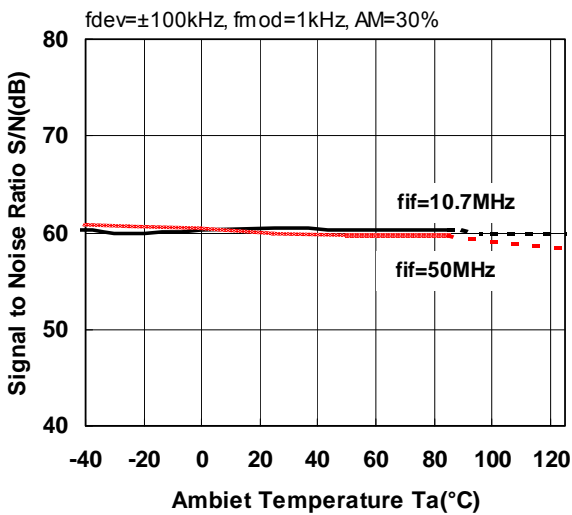

-3dB Limiting Sensitivity versus Temperature

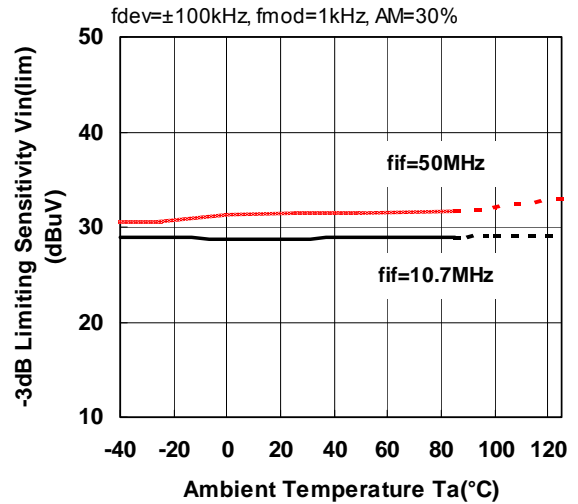

RSSI Output versus Temperature-10.7MHz-

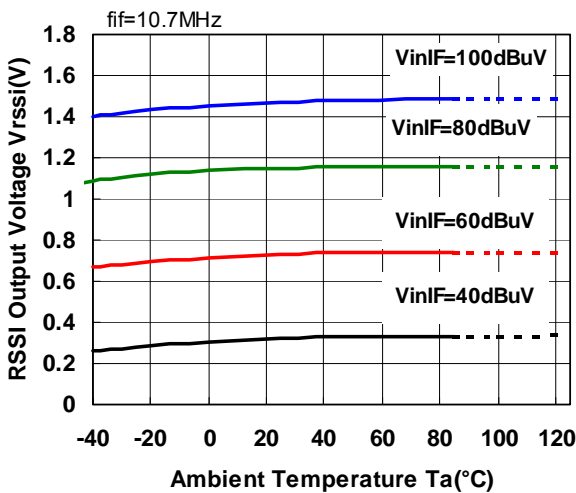

RSSI Output versus Temperature-50MHz-

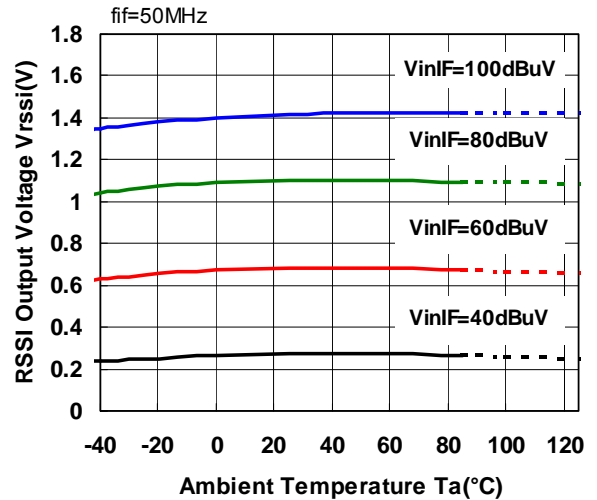

Duty Ratio versus Temperature

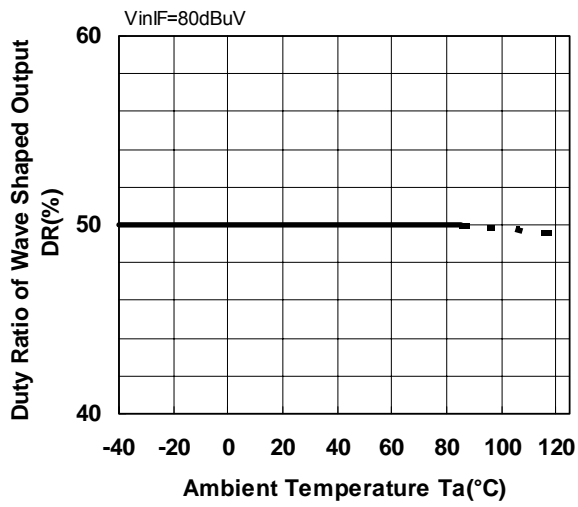

[CAUTION]
The specifications on this databook are only given for information, without any guarantee as regards either mistakes or omissions. The application circuits in this databook are described only to show representative usages of the product and not intended for the guarantee or permission of any right including the industrial rights.

Mouser Electronics

Authorized Distributor

Click to View Pricing, Inventory, Delivery & Lifecycle Information:

[NJR:](#)

[NJM2550V-TE1](#)