



■ Features :

- Controlled by microprocessor
- 2/3/8 stage charging selectable on output panel (Note 4)
- Universal AC input / Full range
- Built-in active PFC function PF>0.95
- Protection: Reverse Polarity / Short circuit / Over voltage / Over temperature
- Charger for lead-acid batteries
- 3 color LED loading indicator
- Built-in remote ON-OFF control
- 2-Bank charger
- Temperature compensation function
- FAN on/off control (depends on charging current)
- 3 years warranty



SPECIFICATION

MODEL		PB-1000-12	PB-1000-24	PB-1000-48
OUTPUT	BOOST CHARGE VOLTAGE	14.4V	28.8V	57.6V
	FLOAT CHARGE VOLTAGE	13.8V	27.6V	55.2V
	OUTPUT CURRENT	60A	34.7A	17.4A
	RECOMMENDED BATTERY CAPACITY(AMP HOURS)(Note 3)	200 ~ 600Ah	120 ~ 350Ah	60 ~ 175Ah
	BATTERY TYPE	Open & Sealed Lead Acid		
	LEAKAGE CURRENT FROM BATTERY (Typ.)	<1mA		
INPUT	VOLTAGE RANGE	90 ~ 264VAC 127 ~ 370VDC		
	FREQUENCY RANGE	47 ~ 63Hz		
	EFFICIENCY (Typ.)	85%	88%	89%
	POWER FACTOR (Typ.)	0.95/230VAC 0.98/115VAC at full load		
	AC CURRENT (Typ.)	12A/115VAC 5.2A/230VAC		
	INRUSH CURRENT (Typ.)	25A/115VAC 50A/230VAC		
	LEAKAGE CURRENT	<3.5mA / 240VAC		
PROTECTION	OVER VOLTAGE	16 ~ 18V	32 ~ 35V	64.5 ~ 69.5V
		Protection type : Shut down o/p voltage, re-power on to recover		
	OVER TEMPERATURE	80°C ±5°C (12V), 85°C ±5°C (24V,48V) (TSW1: detect on heatsink of power transistor)		
		85°C ±5°C (12V), 75°C ±5°C (24V,48V) (TSW2 : detect on heatsink of o/p diode)		
		Protection type : Shut down o/p voltage, recovers automatically after temperature goes down		
	SHORT CIRCUIT	YES, protected by internal circuit		
	REVERSE POLARITY	YES, protected by internal circuit		
FUNCTION	REMOTE CONTROL	Open: Normal work Short: Stop Charging		
	BATTER BANKS	2 banks (A & B)		
	FAST CHARGE	2 / 3 / 8 stage selectable		
	CHARGER OK	Relay contact rating(max.): 30V/1A resistive ; "Short" when the unit is working properly, "Open" when the unit is failure or the protection function is activating		
	OUTPUT OK	Relay contact rating(max.): 30V/1A resistive ; "Short" when the battery is full, "Open" when the battery is still charging		
	TEMPERATURE COMPENSATION	By NTC, compensate both banks at the same time		
	ENVIRONMENT	WORKING TEMP.	-20 ~ +60°C (Refer to output load derating curve)	
WORKING HUMIDITY		20 ~ 90% RH non-condensing		
STORAGE TEMP., HUMIDITY		-40 ~ +85°C, 10 ~ 95% RH		
TEMP. COEFFICIENT		±0.05%/°C (0 ~ 50°C)		
VIBRATION		10 ~ 500Hz, 2G 10min./1cycle, 60min. each along X, Y, Z axes		
SAFETY & EMC (Note 2)	SAFETY STANDARDS	UL60950-1, TUV EN60950-1 approved		
	WITHSTAND VOLTAGE	I/P-O/P:3KVAC I/P-FG:1.5KVAC O/P-FG:0.5KVAC		
	ISOLATION RESISTANCE	I/P-O/P, I/P-FG, O/P-FG:100M Ohms / 500VDC / 25°C / 70% RH		
	EMI CONDUCTION & RADIATION	Compliance to EN55022 (CISPR22)		
	HARMONIC CURRENT	Compliance to EN61000-3-2,-3		
OTHERS	EMS IMMUNITY	Compliance to EN61000-4-2,3,4,5,6,8,11; ENV50204, EN55024, light industry level, criteria A		
	MTBF	127.4Khrs min. MIL-HDBK-217F (25°C)		
	DIMENSION	300*184*70mm(L*W*H)		
	PACKING	3.5Kg; 4pcs/15Kg/1.83CUFT		
NOTE	<p>1. All parameters NOT specially mentioned are measured at 230VAC input, rated load and 25°C of ambient temperature.</p> <p>2. The power supply is considered a component which will be installed into a final equipment. The final equipment must be re-confirmed that it still meets EMC directives.</p> <p>3. This is Mean Well's suggested range. Please consult your battery manufacturer for their suggestions about maximum charging current limitation.</p> <p>4. Please choose the "3 stage" selection when the charger is used to charge the batteries and power the loads in the same time.</p>			

Mechanical Specification

Case No. 804B Unit:mm

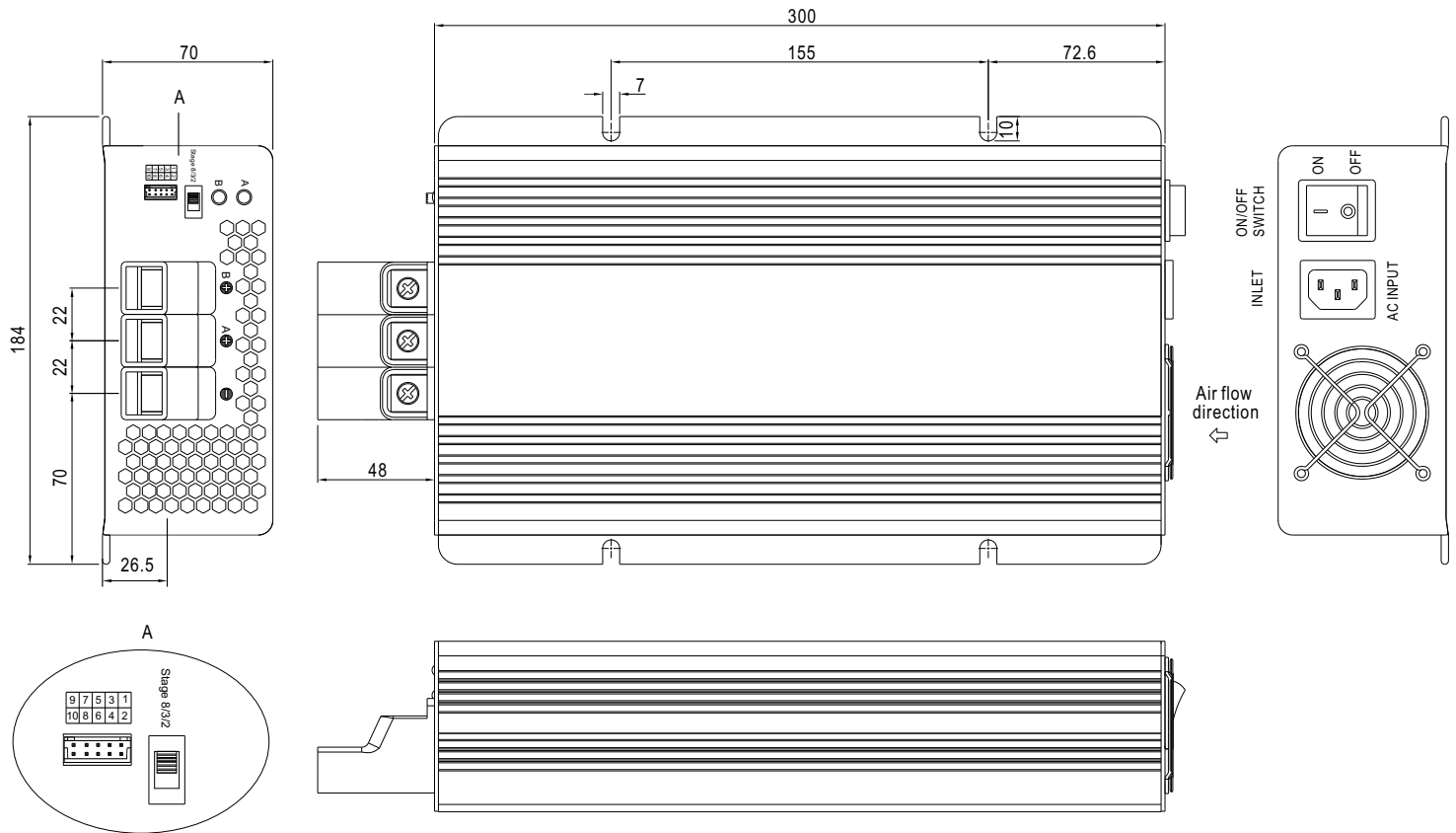

Control Pin No. Assignment(CN100) : HRS DF11-10DP-2DS or equivalent

Pin No.	Assignment	Pin No.	Assignment	Mating Housing	Terminal
1,2	RY13	8	NTC(5KΩ)	HRS DF11-10DS or equivalent	HRS DF11-**SC or equivalent
3,4	RY14	9	RC-		
5,6	RY15	10	RC+		
7	GND				

RY13 : Bank A OK NTC / GND : Temperature sense
 RY14 : Bank B OK RC+ / RC-: Remote ON/OFF
 RY15 : Charger OK

Charging Curve

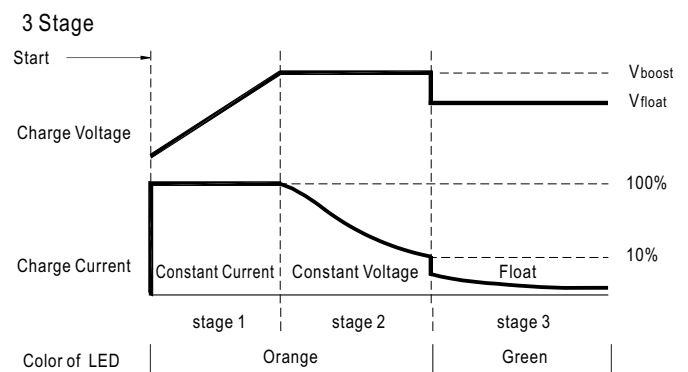
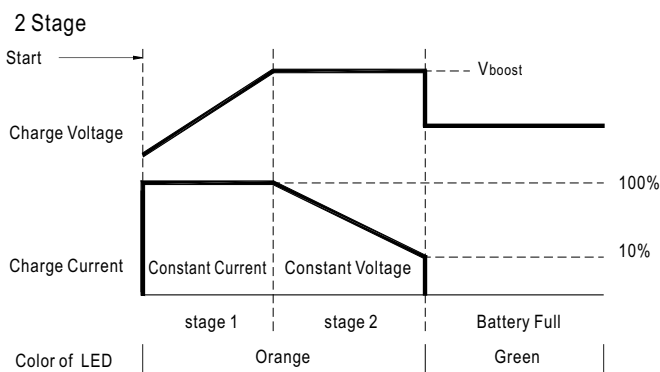

8 Stage

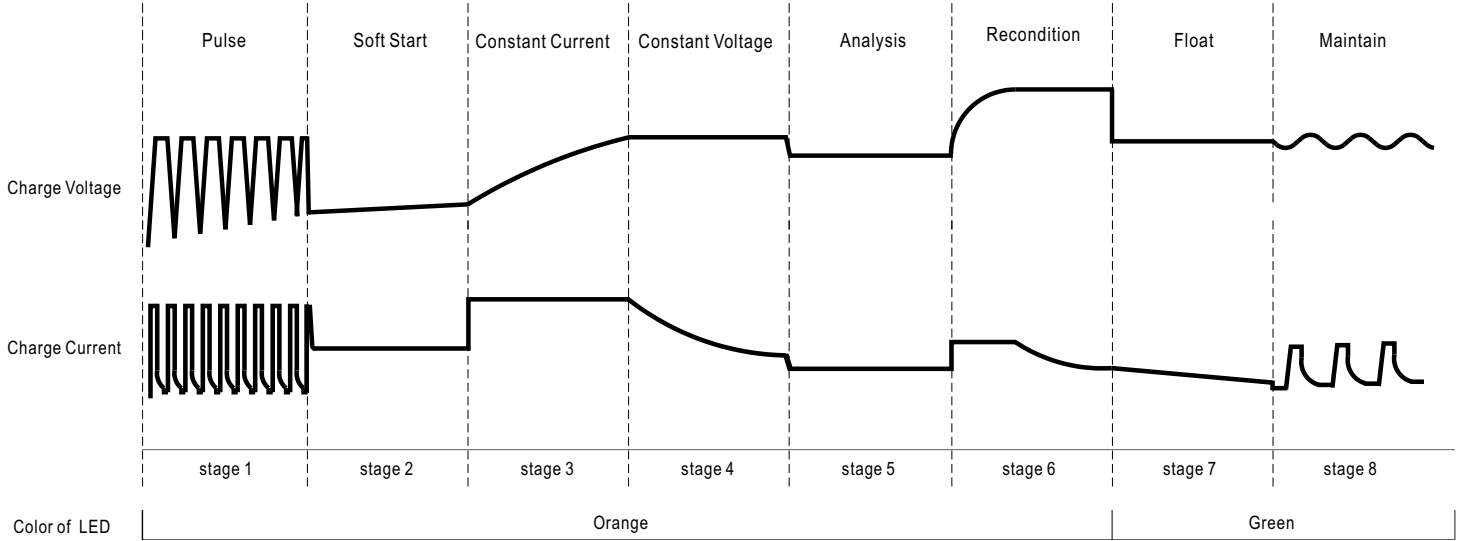

Block Diagram

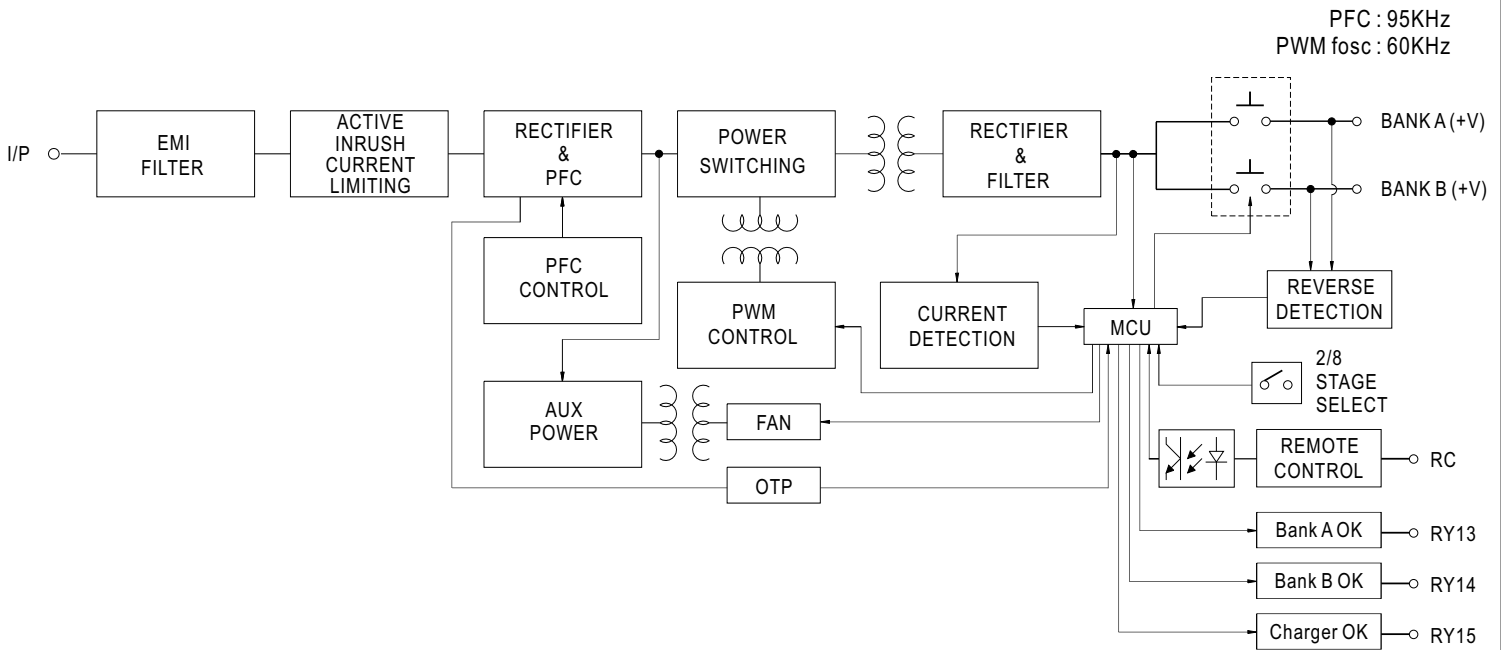

Derating Curve

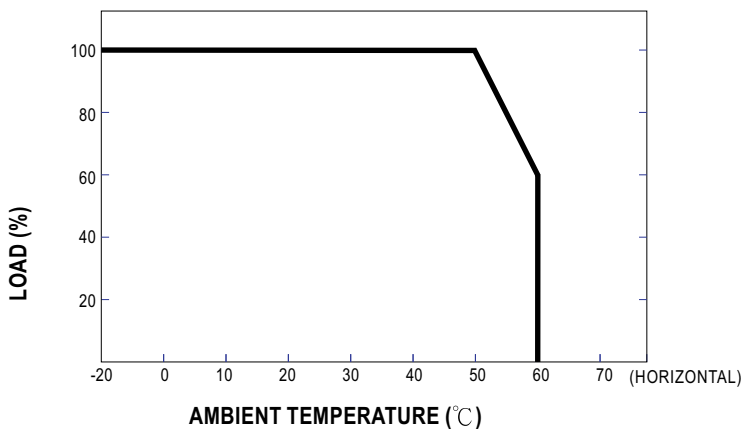

The Function of LEDs

Battery	Color of LED
Fail	Red
Charging	Orange
Battery Full	Green

■ Function Description of CN100

Pin No.	Function	Description
1,2	RY13	Relay contact rating(max.): 30V/1A resistive.; "Short" when the battery A is full, "Open" when the battery A is still charging.
3,4	RY14	Relay contact rating(max.): 30V/1A resistive.; "Short" when the battery B is full, "Open" when the battery B is still charging.
5,6	RY15	Relay contact rating(max.): 30V/1A resistive.; "Short" when the unit is working properly, "Open" when the unit is failure or the protection function is activating.
7,8	GND / RTH	Temperature sensor comes along with the charger can be connected to the unit to allow temperature compensation of the charging voltage. If the temperature sensor is not used, the charger still works normally.
9,10	RC- / RC+	Turn the output on and off by electrical or dry contact between pin 10 (RC+) and pin 9(RC-), "Open" : Normal work , "Short" : Stop charging

■ Function Manual

1.Remote Control

The charger can be turned ON/OFF by using the "Remote Control" function.

Between RC+(pin10) and RC-(pin9)	Charger
SW Open	ON
SW Short	OFF

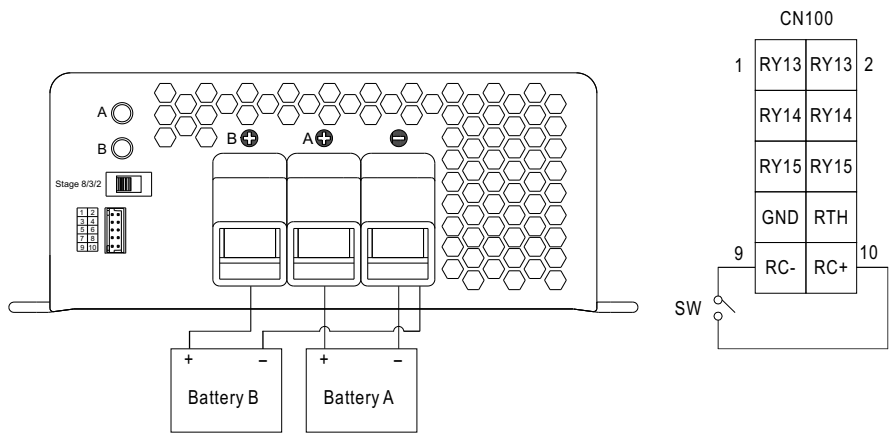

2.Two Battery Banks

The charger may be hooked up two battery banks (A and/or B). Connect the battery bank(s) as below. If you are connecting 2 battery banks in the same time, keep in mind that they must share a common ground.

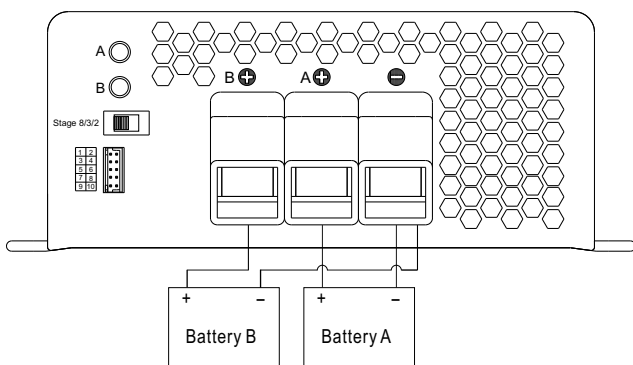
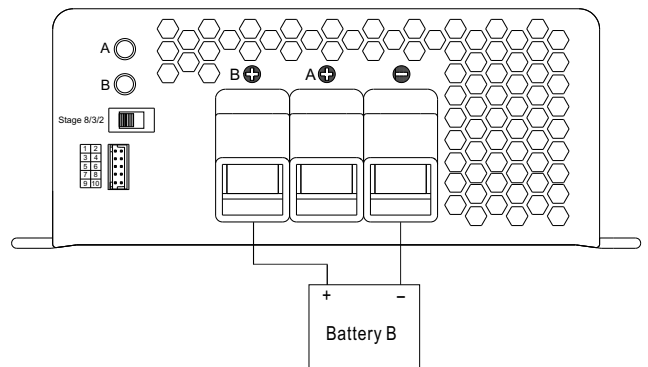
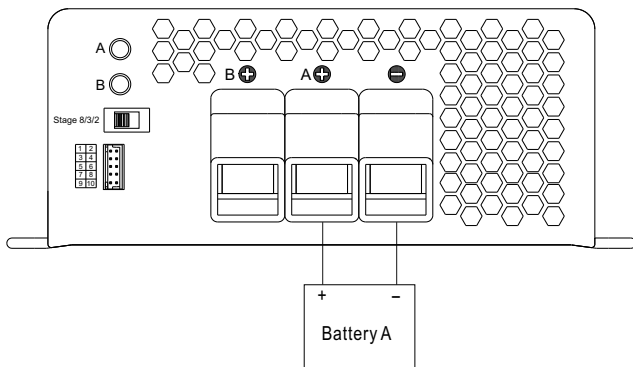

3. 2,3, or 8 stage Charging Select

(1) The charger features user selectable 2, 3, or 8 stage charging. The charging profile is selected by moving the slide switch on the back panel.

Switch	Charging mode
Right	2 stage charging
Middle	3 stage charging
Left	8 stage charging

(2) Please choose the "3 stage" selection when the charger is used to charge the batteries and power the loads in the same time.

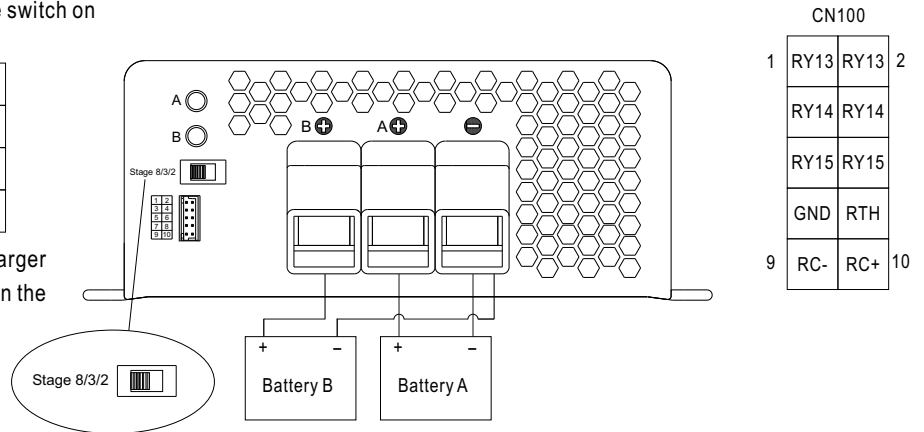

4. Charger OK Relay (RY15)

Charger	Between pin5 and pin6 (RY15)
Normal work	ON (Short)
Failure or the protection function is activating	OFF (Open)

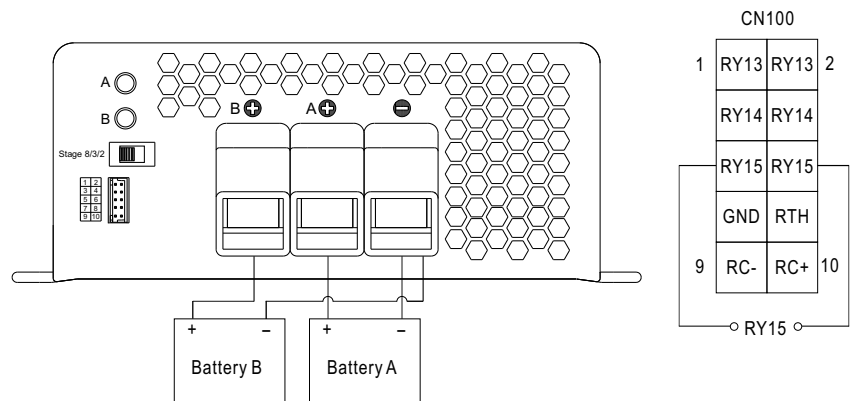

5. Output OK Relay (RY13 & RY14)

1. Bank A OK (RY13)

Bank A	Between pin1 and pin2 (RY13)	Color of LED A
Battery A Full	ON (Short)	Green
Charging	OFF (Open)	Orange

2. Bank B OK (RY14)

Bank B	Between pin3 and pin4 (RY14)	Color of LED B
Battery B Full	ON (Short)	Green
Charging	OFF (Open)	Orange

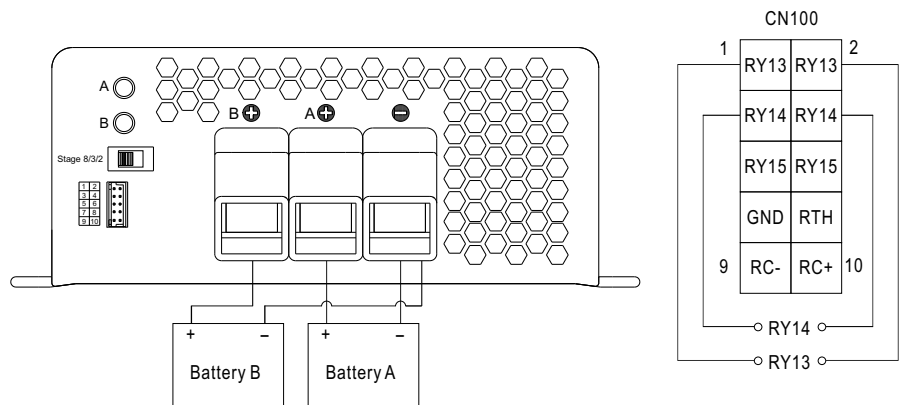

6. Temperature Compensation

Temperature sensor comes along with the charger can be connected to the unit to allow temperature compensation of the charging voltage.

If the temperature sensor is not used, the charger still works normally.

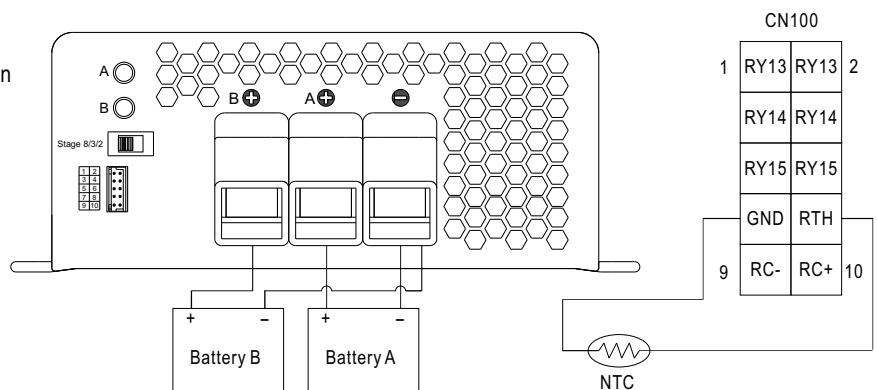

The temperature sensor can either be attached to the battery or placed in its surrounding environment.