

3-TERMINAL POSITIVE VOLTAGE REGULATOR

■ GENERAL DESCRIPTION

The NJM7800 series of monolithic 3-Terminal Positive Voltage Regulators is constructed using the New JRC Planar epitaxial process. These regulators employ internal current-limiting, thermal-shutdown and safe-area compensation making them essentially indestructible. If adequate heat sinking is provided, they can deliver over 1A output current. They are intended as fixed voltage regulators in a wide range of applications including local (on card) regulation for elimination of distribution problems associated with single point regulation. In addition to use as fixed voltage regulators, these devices can be used with external components to obtain adjustable output voltages and currents.

■ FEATURES

- Internal Short Circuit Current Limit
- Internal Thermal Overload Protection
- Excellent Ripple Rejection
- Guarantee'd 1.5A Output Current
- Package Outline TO-220F, TO-252
- Bipolar Technology

■ EQUIVALENT CIRCUIT

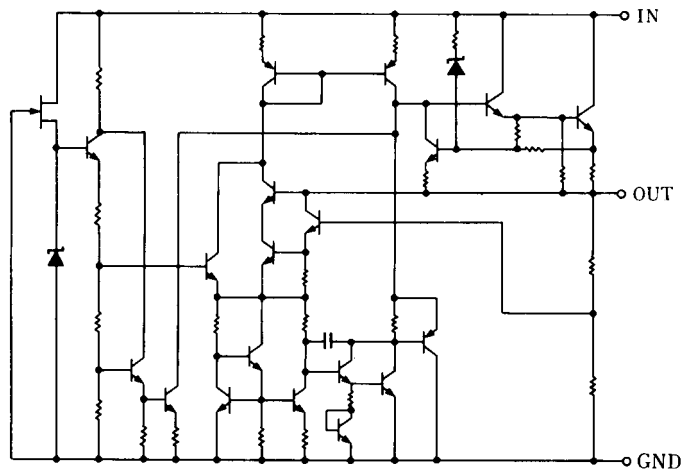

■ PACKAGE OUTLINE

(TO-220F)



(TO-252)

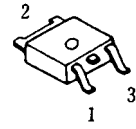

NJM7800FA

1. IN
2. GND
3. OUT

NJM7800DL1A

1. IN
2. GND
3. OUT

(note) The radiation fin is connected pin2.

NJM7800

■ ABSOLUTE MAXIMUM RATINGS

(Ta=25°C)

PARAMETER	SYMBOL	MAXIMUM RATINGS		UNIT
Input Voltage	V _{IN}	7805 to 7810 7812 to 7815 7818 to 7824	35 35 40	V
Storage Temperature Range	T _{stg}	-40 to +150		°C
Operating Temperature Range	Operating Junction Temperature	T _j	-40 to +150	°C
	Operating Junction Temperature	T _{opr}	-40 to +85	
Power Dissipation	P _D	TO-220F TO-252	16(T _C ≤70°C) 10(T _C =25°C) 1(Ta≤25°C)	W

■ THERMAL CHARACTERISTICS

			TO-220F	TO-252		
Thermal Resistance	Junction-to-Ambient Temperature	θ _{ja}	60	125	°C/W	
	Junction-to-Case	θ _{jc}	5	12.5		

■ ELECTRICAL CHARACTERISTICS (C₁=0.33μF, C_O=0.1μF, T_J=25°C)

Measurement is to be conducted in pulse testing.

PARAMETER	SYMBOL	TEST CONDITIONS	TO-220F			TO-252			UNIT
			MIN.	TYP.	MAX.	MIN.	TYP.	MAX.	
NJM7805FA/DL1A									
Output Voltage	V _O	V _{IN} =10V, I _O =0.5A	4.8	5.0	5.2	4.8	5.0	5.2	V
Quiescent Current	I _Q	V _{IN} =10V, I _O =0mA	-	4.2	6.0	-	4.2	6.0	mA
Load Regulation	ΔV _O - I _O	V _{IN} =10V, I _O =0.005 to 1.5A	-	15	50	-	15	100	mV
Line Regulation	ΔV _O - V _{IN}	V _{IN} =7 to 25V, I _O =0.5A	-	3	50	-	3	100	mV
Ripple Rejection	RR	V _{IN} =10V, I _O =0.5A, e _{in} =2V _{P-P} , f=120Hz	68	78	-	68	78	-	dB
Output Noise Voltage	V _{NO}	V _{IN} =10V, BW=10Hz to 100kHz, I _O =0.5A	-	45	-	-	45	-	μV
Average Temperature Coefficient of Output Voltage	ΔV _O /ΔT	V _{IN} =10V, I _O =5mA	-	-0.5	-	-	-0.5	-	mV/°C

■ **ELECTRICAL CHARACTERISTICS** ($C_1=0.33\mu\text{F}$, $C_O=0.1\mu\text{F}$, $T_f=25^\circ\text{C}$)

Measurement is to be conducted in pulse testing.

PARAMETER	SYMBOL	TEST CONDITIONS	TO-220F			TO-252			UNIT
			MIN.	TYP.	MAX.	MIN.	TYP.	MAX.	
NJM7806FA/DL1A									
Output Voltage	V_O	$V_{IN}=11\text{V}$, $I_O=0.5\text{A}$	5.75	6.0	6.25	5.75	6.0	6.25	V
Quiescent Current	I_Q	$V_{IN}=11\text{V}$, $I_O=0\text{mA}$	-	4.3	6.0	-	4.3	6.0	mA
Load Regulation	$\Delta V_O - I_O$	$V_{IN}=11\text{V}$, $I_O=0.005$ to 1.5A	-	15	60	-	15	120	mV
Line Regulation	$\Delta V_O - V_{IN}$	$V_{IN}=8$ to 25V , $I_O=0.5\text{A}$	-	5	60	-	5	120	mV
Ripple Rejection	RR	$V_{IN}=11\text{V}$, $I_O=0.5\text{A}$, $e_{in}=2V_{P-P}$, $f=120\text{Hz}$	65	75	-	65	75	-	dB
Output Noise Voltage	V_{NO}	$V_{IN}=11\text{V}$, $BW=10\text{Hz}$ to 100kHz , $I_O=0.5\text{A}$	-	45	-	-	45	-	μV
Average Temperature Coefficient of Output Voltage	$\Delta V_O/\Delta T$	$V_{IN}=11\text{V}$, $I_O=5\text{mA}$	-	-0.6	-	-	-0.6	-	$\text{mV}/^\circ\text{C}$
NJM7808FA/DL1A									
Output Voltage	V_O	$V_{IN}=14\text{V}$, $I_O=0.5\text{A}$	7.7	8.0	8.3	7.7	8.0	8.3	V
Quiescent Current	I_Q	$V_{IN}=14\text{V}$, $I_O=0\text{mA}$	-	4.3	6.0	-	4.3	6.0	mA
Load Regulation	$\Delta V_O - I_O$	$V_{IN}=14\text{V}$, $I_O=0.005$ to 1.5A	-	15	80	-	15	160	mV
Line Regulation	$\Delta V_O - V_{IN}$	$V_{IN}=10.5$ to 25V , $I_O=0.5\text{A}$	-	6	80	-	6	160	mV
Ripple Rejection	RR	$V_{IN}=14\text{V}$, $I_O=0.5\text{A}$, $e_{in}=2V_{P-P}$, $f=120\text{Hz}$	62	72	-	62	72	-	dB
Output Noise Voltage	V_{NO}	$V_{IN}=14\text{V}$, $BW=10\text{Hz}$ to 100kHz , $I_O=0.5\text{A}$	-	55	-	-	55	-	μV
Average Temperature Coefficient of Output Voltage	$\Delta V_O/\Delta T$	$V_{IN}=14\text{V}$, $I_O=5\text{mA}$	-	-0.8	-	-	-0.8	-	$\text{mV}/^\circ\text{C}$
NJM7809FA/DL1A									
Output Voltage	V_O	$V_{IN}=15\text{V}$, $I_O=0.5\text{A}$	8.65	9.0	9.35	8.65	9.0	9.35	V
Quiescent Current	I_Q	$V_{IN}=15\text{V}$, $I_O=0\text{mA}$	-	4.3	6.0	-	4.3	6.0	mA
Load Regulation	$\Delta V_O - I_O$	$V_{IN}=15\text{V}$, $I_O=0.005$ to 1.5A	-	15	90	-	15	180	mV
Line Regulation	$\Delta V_O - V_{IN}$	$V_{IN}=11.5$ to 25V , $I_O=0.5\text{A}$	-	7	90	-	7	180	mV
Ripple Rejection	RR	$V_{IN}=15\text{V}$, $I_O=0.5\text{A}$, $e_{in}=2V_{P-P}$, $f=120\text{Hz}$	62	72	-	62	72	-	dB
Output Noise Voltage	V_{NO}	$V_{IN}=15\text{V}$, $BW=10\text{Hz}$ to 100kHz , $I_O=0.5\text{A}$	-	60	-	-	60	-	μV
Average Temperature Coefficient of Output Voltage	$\Delta V_O/\Delta T$	$V_{IN}=15\text{V}$, $I_O=5\text{mA}$	-	-0.9	-	-	-0.9	-	$\text{mV}/^\circ\text{C}$
NJM7810FA/DL1A									
Output Voltage	V_O	$V_{IN}=17\text{V}$, $I_O=0.5\text{A}$	9.60	10.0	10.4	9.6	10.0	10.4	V
Quiescent Current	I_Q	$V_{IN}=17\text{V}$, $I_O=0\text{mA}$	-	4.3	6.0	-	4.3	6.0	mA
Load Regulation	$\Delta V_O - I_O$	$V_{IN}=17\text{V}$, $I_O=0.005$ to 1.5A	-	15	130	-	15	200	mV
Line Regulation	$\Delta V_O - V_{IN}$	$V_{IN}=12.5$ to 25V , $I_O=0.5\text{A}$	-	7	100	-	7	200	mV
Ripple Rejection	RR	$V_{IN}=17\text{V}$, $I_O=0.5\text{A}$, $e_{in}=2V_{P-P}$, $f=120\text{Hz}$	62	72	-	62	72	-	dB
Output Noise Voltage	V_{NO}	$V_{IN}=17\text{V}$, $BW=10\text{Hz}$ to 100kHz , $I_O=0.5\text{A}$	-	60	-	-	65	-	μV
Average Temperature Coefficient of Output Voltage	$\Delta V_O/\Delta T$	$V_{IN}=17\text{V}$, $I_O=5\text{mA}$	-	-0.9	-	-	-1.0	-	$\text{mV}/^\circ\text{C}$

NJM7800

■ ELECTRICAL CHARACTERISTICS (C₁=0.33μF, C_O=0.1μF, T_J=25°C)

Measurement is to be conducted in pulse testing.

PARAMETER	SYMBOL	TEST CONDITIONS	TO-220F			TO-252			UNIT
			MIN.	TYP.	MAX.	MIN.	TYP.	MAX.	
NJM7812FA/DL1A									
Output Voltage	V _O	V _{IN} =19V, I _O =0.5A	11.5	12.0	12.5	11.5	12.0	12.5	V
Quiescent Current	I _Q	V _{IN} =19V, I _O =0mA	-	4.3	6.0	-	4.3	6.0	mA
Load Regulation	ΔV _O - I _O	V _{IN} =19V, I _O =0.005 to 1.5A	-	25	120	-	25	240	mV
Line Regulation	ΔV _O - V _{IN}	V _{IN} =14.5 to 30V, I _O =0.5A	-	10	120	-	10	240	mV
Ripple Rejection	RR	V _{IN} =19V, I _O =0.5A, e _{in} =2V _{P-P} , f=120Hz	61	71	-	61	71	-	dB
Output Noise Voltage	V _{NO}	V _{IN} =19V, BW=10Hz to 100kHz, I _O =0.5A	-	75	-	-	75	-	μV
Average Temperature Coefficient of Output Voltage	ΔV _O /ΔT	V _{IN} =19V, I _O =5mA	-	-1.2	-	-	-1.2	-	mV/°C
NJM7815FA/DL1A									
Output Voltage	V _O	V _{IN} =23V, I _O =0.5A	14.4	15.0	15.6	14.4	15.0	15.6	V
Quiescent Current	I _Q	V _{IN} =23V, I _O =0mA	-	4.4	6.0	-	4.4	6.0	mA
Load Regulation	ΔV _O - I _O	V _{IN} =23V, I _O =0.005 to 1.5A	-	35	150	-	35	300	mV
Line Regulation	ΔV _O - V _{IN}	V _{IN} =17.5 to 30V, I _O =0.5A	-	11	150	-	11	300	mV
Ripple Rejection	RR	V _{IN} =23V, I _O =0.5A, e _{in} =2V _{P-P} , f=120Hz	60	70	-	60	70	-	dB
Output Noise Voltage	V _{NO}	V _{IN} =23V, BW=10Hz to 100kHz, I _O =0.5A	-	90	-	-	90	-	μV
Average Temperature Coefficient of Output Voltage	ΔV _O /ΔT	V _{IN} =23V, I _O =5mA	-	-1.5	-	-	-1.5	-	mV/°C
NJM7818FA/DL1A									
Output Voltage	V _O	V _{IN} =27V, I _O =0.5A	17.3	18.0	18.7	17.3	18.0	18.7	V
Quiescent Current	I _Q	V _{IN} =27V, I _O =0mA	-	4.5	6.0	-	4.5	6.0	mA
Load Regulation	ΔV _O - I _O	V _{IN} =27V, I _O =0.005 to 1.5A	-	55	180	-	55	360	mV
Line Regulation	ΔV _O - V _{IN}	V _{IN} =21 to 33V, I _O =0.5A	-	15	180	-	15	360	mV
Ripple Rejection	RR	V _{IN} =27V, I _O =0.5A, e _{in} =2V _{P-P} , f=120Hz	59	69	-	59	69	-	dB
Output Noise Voltage	V _{NO}	V _{IN} =27V, BW=10Hz to 100kHz, I _O =0.5A	-	100	-	-	100	-	μV
Average Temperature Coefficient of Output Voltage	ΔV _O /ΔT	V _{IN} =27V, I _O =5mA	-	-1.8	-	-	-1.8	-	mV/°C
NJM7820FA/DL1A									
Output Voltage	V _O	V _{IN} =29V, I _O =0.5A	19.2	20.0	20.8	19.2	20.0	20.8	V
Quiescent Current	I _Q	V _{IN} =29V, I _O =0mA	-	4.5	6.0	-	4.5	6.0	mA
Load Regulation	ΔV _O - I _O	V _{IN} =29V, I _O =0.005 to 1.5A	-	61	200	-	61	400	mV
Line Regulation	ΔV _O - V _{IN}	V _{IN} =23 to 35V, I _O =0.5A	-	16	200	-	16	400	mV
Ripple Rejection	RR	V _{IN} =29V, I _O =0.5A, e _{in} =2V _{P-P} , f=120Hz	58	68	-	58	68	-	dB
Output Noise Voltage	V _{NO}	V _{IN} =29V, BW=10Hz to 100kHz, I _O =0.5A	-	120	-	-	120	-	μV
Average Temperature Coefficient of Output Voltage	ΔV _O /ΔT	V _{IN} =29V, I _O =5mA	-	-2.0	-	-	-2.0	-	mV/°C

■ **ELECTRICAL CHARACTERISTICS** ($C_1=0.33\mu\text{F}$, $C_O=0.1\mu\text{F}$, $T_f=25^\circ\text{C}$)

Measurement is to be conducted in pulse testing.

PARAMETER	SYMBOL	TEST CONDITIONS	TO-220F			TO-252			UNIT
			MIN.	TYP.	MAX.	MIN.	TYP.	MAX.	
NJM7824FA/DL1A									
Output Voltage	V_O	$V_{IN}=33\text{V}$, $I_O=0.5\text{A}$	23.0	24.0	25.0	23.0	24.0	25.0	V
Quiescent Current	I_Q	$V_{IN}=33\text{V}$, $I_O=0\text{mA}$	-	4.6	6.0	-	4.6	6.0	mA
Load Regulation	$\Delta V_O - I_O$	$V_{IN}=33\text{V}$, $I_O=0.005$ to 1.5A	-	65	240	-	65	480	mV
Line Regulation	$\Delta V_O - V_{IN}$	$V_{IN}=27$ to 38V , $I_O=0.5\text{A}$	-	18	240	-	18	480	mV
Ripple Rejection	RR	$V_{IN}=33\text{V}$, $I_O=0.5\text{A}$, $e_{in}=2V_{P-P}$, $f=120\text{Hz}$	56	66	-	56	66	-	dB
Output Noise Voltage	V_{NO}	$V_{IN}=33\text{V}$, $BW=10\text{Hz}$ to 100kHz , $I_O=0.5\text{A}$	-	120	-	-	120	-	μV
Average Temperature Coefficient of Output Voltage	$\Delta V_O/\Delta T$	$V_{IN}=33\text{V}$, $I_O=5\text{mA}$	-	-2.4	-	-	-2.4	-	$\text{mV}/^\circ\text{C}$

NJM7800

POWER DISSIPATION VS. AMBIENT TEMPERATURE

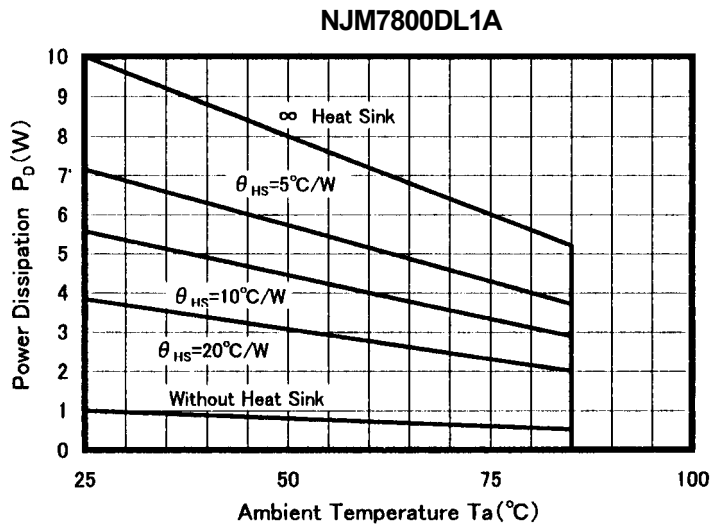
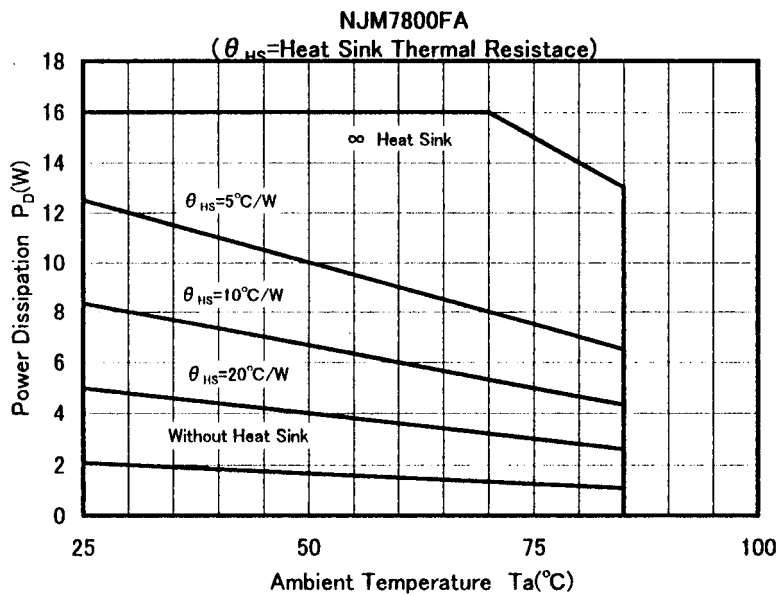

TEST CIRCUIT

1. Output Voltage, Line Regulation, Load Regulation, Quiescent Current, Average Temperature Coefficient of Output Voltage, Output Noise Voltage

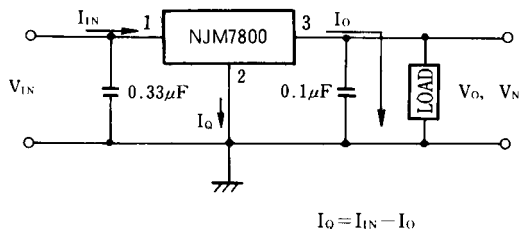

2. Ripple Rejection

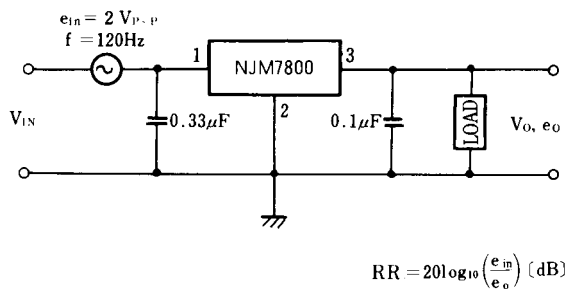

■ Input Capacitor C_{IN}

Input Capacitor C_{IN} is required to prevent oscillation and reduce power supply ripple for applications when high power supply impedance or a long power supply line.

Therefore, use the recommended C_{IN} value (refer to conditions of ELECTRIC CHARACTERISTIC) or larger and should connect between GND and V_{IN} as shortest path as possible to avoid the problem.

■ Output Capacitor C_O

Output capacitor (C_O) will be required for a phase compensation of the internal error amplifier.

The capacitance and the equivalent series resistance (ESR) influence to stable operation of the regulator.

Use of a smaller C_O may cause excess output noise or oscillation of the regulator due to lack of the phase compensation.

On the other hand, Use of a larger C_O reduces output noise and ripple output, and also improves output transient response when rapid load change.

Therefore, use the recommended C_O value (refer to conditions of ELECTRIC CHARACTERISTIC) or larger and should connect between GND and V_{OUT} as shortest path as possible for stable operation

In addition, you should consider varied characteristics of capacitor (a frequency characteristic, a temperature characteristic, a DC bias characteristic and so on) and unevenness peculiar to a capacitor supplier enough.

When selecting C_O , recommend that have withstand voltage margin against output voltage and superior temperature characteristic though

NJM7800

■ TYPICAL CHARACTERISTICS

NJM7805 Output Voltage vs. Temperature

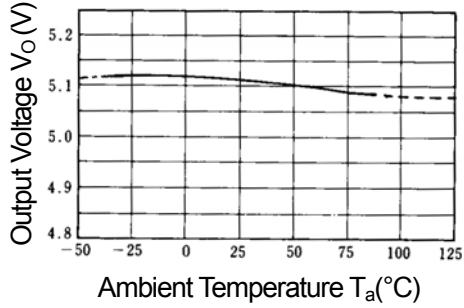

NJM7808 Output Voltage vs. Temperature

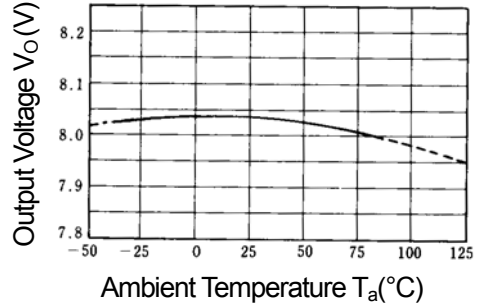

NJM78M00 Series Equivalent Series Resistance vs. Output Current

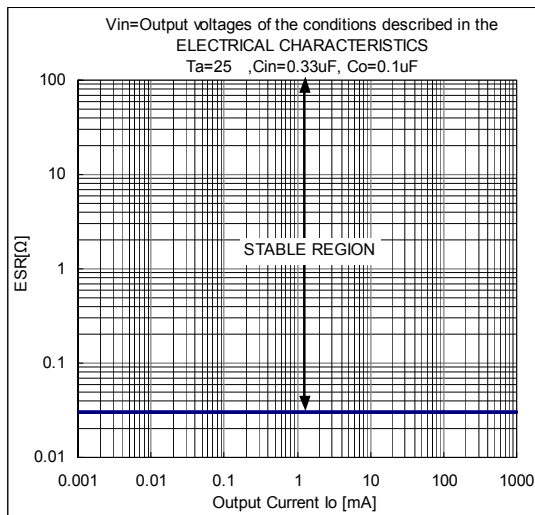

■ TYPICAL CHARACTERISTICS

NJM7805/15/24 Output Characteristics ($I_o=0.5A$, $T_j=25^\circ C$)

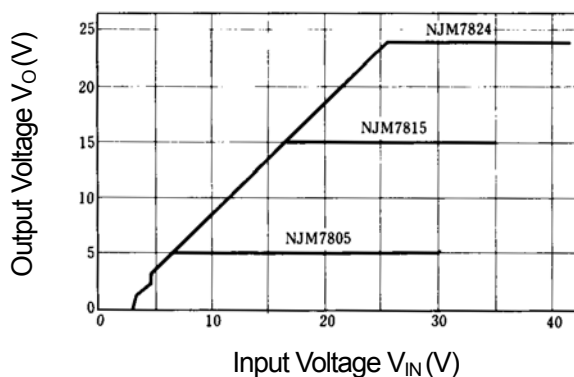

NJM7805 Dropout Characteristics ($T_j=25^\circ C$)

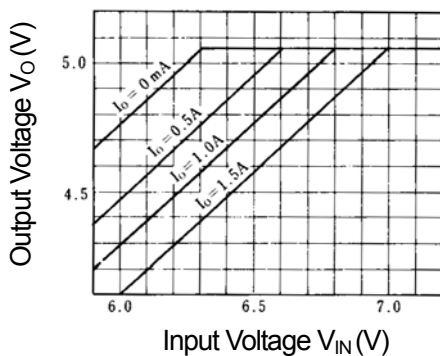

NJM7812 Dropout Characteristics ($T_j=25^\circ C$)

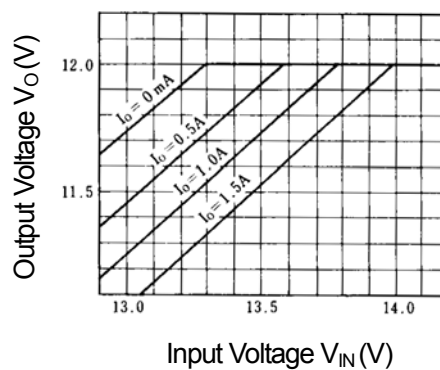

NJM7805/15/24 Load Characteristics ($T_j=25^\circ C$)

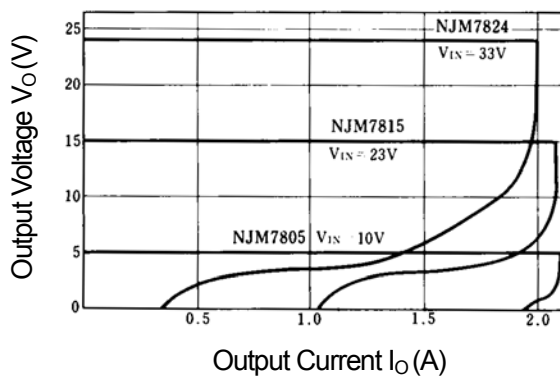

NJM7800

■ TYPICAL CHARACTERISTICS

NJM7800 Series Short Circuit Output Current

($T_j=25^\circ\text{C}$, ∞ Heat Sink)

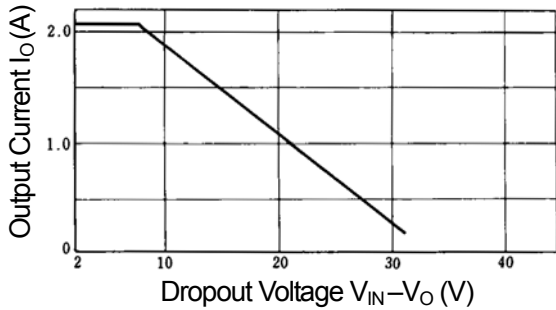

NJM7805/24 Quiescent Current vs. Input Voltage

($T_j=25^\circ\text{C}$.)

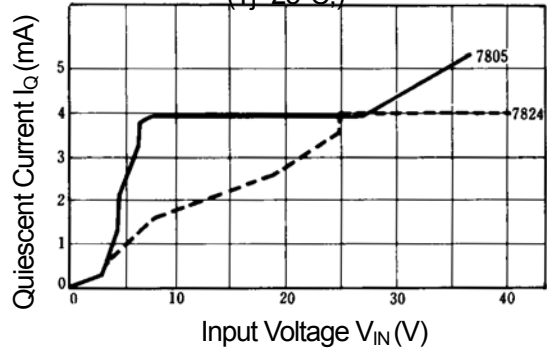

NJM7805/15/24 Output Voltage vs. Junction Temperature

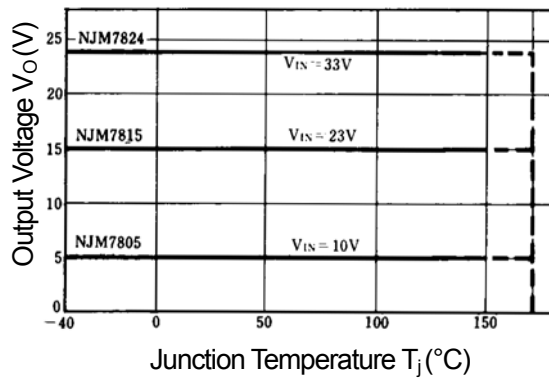

NJM7805/15/24 Ripple Rejection vs. Frequency

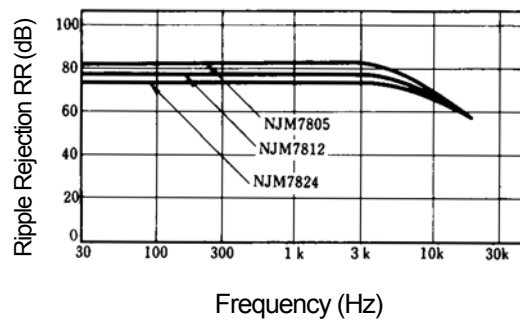

$V_{IN} = 10\text{V (05)}$ $e_{in} = 2V_{P-P}$
 19V (12)
 33V (24)
 $T_j = 25^\circ\text{C}$

[CAUTION]
 The specifications on this databook are only given for information, without any guarantee as regards either mistakes or omissions. The application circuits in this databook are described only to show representative usages of the product and not intended for the guarantee or permission of any right including the industrial rights.

Mouser Electronics

Authorized Distributor

Click to View Pricing, Inventory, Delivery & Lifecycle Information:

[NJR:](#)

[NJM7812DL1A-TE1](#) [NJM7808DL1A-TE2](#) [NJM7808DL1A-TE1](#) [NJM7809DL1A-TE1](#) [NJM7815DL1A-TE1](#)
[NJM7820DL1A-TE1](#) [NJM7824DL1A-TE1](#) [NJM7805DL1A-TE1](#) [NJM7805DL1A-TE2](#) [NJM7810DL1A-TE1](#) [NJM7806FA](#)
[NJM7810FA](#) [NJM7818DL1A-TE1](#) [NJM7806DL1A-TE1](#)