

## Optocoupler, Phototransistor Output, AC Input, with Base Connection

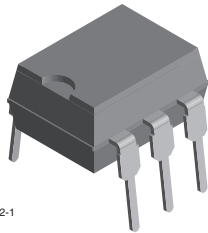

21842-1

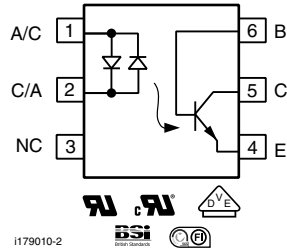

1179010-2



### FEATURES

- AC or polarity insensitive input
- Built-in reverse polarity input protection
- I/O compatible with integrated circuits
- Industry standard DIP package
- Isolation test voltage: 5300 V<sub>RMS</sub>
- Compliant to RoHS Directive 2002/95/EC and in accordance to WEEE 2002/96/EC



**RoHS**  
COMPLIANT

### DESCRIPTION

The H11AA1 is a bi-directional input optically coupled isolator consisting of two inverse parallel gallium arsenide infrared LEDs coupled to a silicon NPN phototransistor in a 6 pin DIP package. The H11AA1 has a minimum CTR of 20 %, a CTR symmetry of 1:3 and is designed for applications requiring detection or monitoring of AC signals.

### APPLICATIONS

- Telephone line detection
- AC line motor
- PLC
- Instrumentation

### AGENCY APPROVALS

- UL1577, file no. E52744 system code H, double protection
- CSA 93751
- BSI IEC 60950; IEC 60065
- DIN EN 60747-5-2 (VDE0884)/DIN EN 60747-5-5 (pending), available with option 1
- FIMKO

### ORDERING INFORMATION

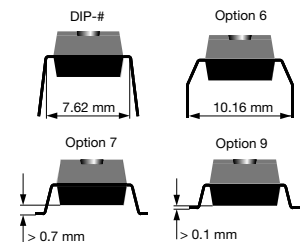
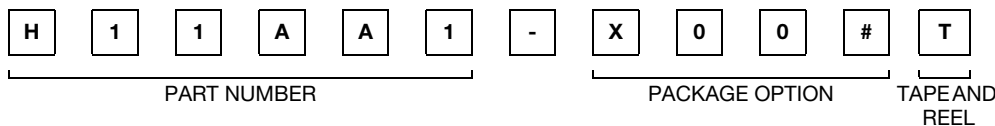

AGENCY CERTIFIED/PACKAGE	CTR (%)
<b>UL, cUL, BSI, FIMKO</b>	<b>≥ 20</b>
DIP-6	H11AA1
DIP-6, 400 mil, option 6	H11AA1-X006
SMD-6, option 7	H11AA1-X007T <sup>(1)</sup>
SMD-6, option 9	H11AA1-X009T <sup>(1)</sup>
<b>VDE, UL, cUL, BSI, FIMKO</b>	<b>≥ 20</b>
DIP-6	H11AA1-X001

### Note

- Additional options may be possible, please contact sales office.
- <sup>(1)</sup> Also available in tubes; do not add T to end.

Vishay Semiconductors Optocoupler, Phototransistor Output,  
AC Input, with Base Connection

<b>ABSOLUTE MAXIMUM RATINGS</b> ( $T_{amb} = 25\text{ }^{\circ}\text{C}$ , unless otherwise specified)				
PARAMETER	TEST CONDITION	SYMBOL	VALUE	UNIT
<b>INPUT</b>				
Forward continuous current		$I_F$	$\pm 60$	mA
Power dissipation		$P_{diss}$	100	mW
Derate linearly from 25 °C			1.3	mW/°C
<b>OUTPUT</b>				
Power dissipation		$P_{diss}$	200	mW
Derate linearly from 25 °C			2.6	mW/°C
Collector emitter breakdown voltage		$BV_{CEO}$	30	V
Emitter base breakdown voltage		$BV_{EBO}$	5	V
Collector base breakdown voltage		$BV_{CBO}$	70	V
<b>COUPLER</b>				
Isolation test voltage (RMS)	Between emitter and detector, referred to standard climate 23 °C/50% RH, DIN 50014	$V_{ISO}$	5300	$V_{RMS}$
Creepage distance			$\geq 7$	mm
Clearance distance			$\geq 7$	mm
Comparative tracking index	per DIN IEC 112/VDE 0303, part 1	CTI	175	
Isolation resistance	$V_{IO} = 500\text{ V}$ , $T_{amb} = 25\text{ }^{\circ}\text{C}$	$R_{IO}$	$\geq 10^{12}$	$\Omega$
	$V_{IO} = 500\text{ V}$ , $T_{amb} = 100\text{ }^{\circ}\text{C}$	$R_{IO}$	$\geq 10^{11}$	$\Omega$
Storage temperature range		$T_{stg}$	- 55 to + 150	°C
Operating temperature range		$T_{amb}$	- 55 to + 100	°C
Lead soldering time at 260 °C		$T_{sld}$	10	s

**Note**

- Stresses in excess of the absolute maximum ratings can cause permanent damage to the device. Functional operation of the device is not implied at these or any other conditions in excess of those given in the operational sections of this document. Exposure to absolute maximum ratings for extended periods of the time can adversely affect reliability.

<b>ELECTRICAL CHARACTERISTICS</b> ( $T_{amb} = 25\text{ }^{\circ}\text{C}$ , unless otherwise specified)						
PARAMETER	TEST CONDITION	SYMBOL	MIN.	TYP.	MAX.	UNIT
<b>INPUT</b>						
Forward voltage	$I_F = \pm 10\text{ mA}$	$V_F$		1.2	1.5	V
<b>OUTPUT</b>						
Collector emitter breakdown voltage	$I_C = 1\text{ mA}$	$BV_{CEO}$	30			V
Emitter base breakdown voltage	$I_E = 100\text{ }\mu\text{A}$	$BV_{EBO}$	5			V
Collector base breakdown voltage	$I_C = 100\text{ }\mu\text{A}$	$BV_{CBO}$	70			V
Collector emitter leakage current	$V_{CE} = 10\text{ V}$	$I_{CEO}$		5	100	nA
<b>COUPLER</b>						
Collector emitter saturation voltage	$I_F = \pm 10\text{ mA}$ , $I_C = 0.5\text{ mA}$	$V_{CEsat}$			0.4	V

**Note**

- Minimum and maximum values were tested requirements. Typical values are characteristics of the device and are the result of engineering evaluations. Typical values are for information only and are not part of the testing requirements.

<b>CURRENT TRANSFER RATIO</b> ( $T_{amb} = 25\text{ }^{\circ}\text{C}$ , unless otherwise specified)						
PARAMETER	TEST CONDITION	SYMBOL	MIN.	TYP.	MAX.	UNIT
DC current transfer ratio	$I_F = \pm 10\text{ mA}$ , $V_{CE} = 10\text{ V}$	$CTR_{DC}$	20			%
Symmetry (CTR at + 10 mA)/(CTR at - 10 mA)			0.33	1	3	

### TYPICAL CHARACTERISTICS ( $T_{amb} = 25\text{ }^{\circ}\text{C}$ , unless otherwise specified)



ih11aa1\_01  
Fig. 1 - LED Forward Current vs. Forward Voltage



ih11aa1\_04  
Fig. 4 - Normalized Non-Saturated and Saturated CTR vs. LED Current



ih11aa1\_02  
Fig. 2 - Normalized Non-Saturated and Saturated CTR vs. LED Current



ih11aa1\_05  
Fig. 5 - Normalized Non-Saturated and Saturated CTR vs. LED Current



ih11aa1\_03  
Fig. 3 - Normalized Non-Saturated and Saturated CTR vs. LED Current

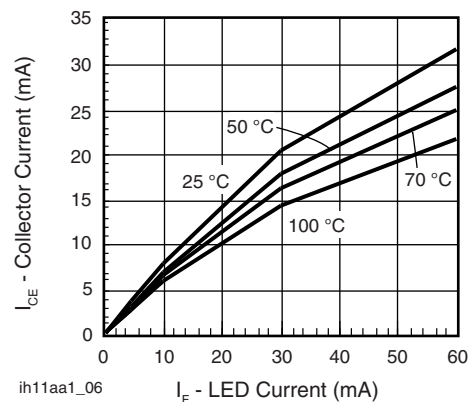

ih11aa1\_06  
Fig. 6 - Collector Emitter Current vs. Temperature and LED Current

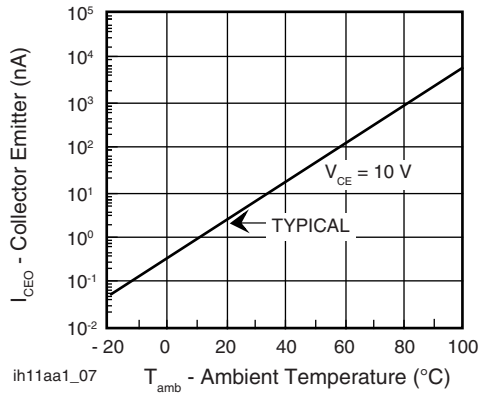

Fig. 7 - Collector Emitter Leakage Current vs. Temperature



Fig. 10 - Normalized Photocurrent vs. LED Current

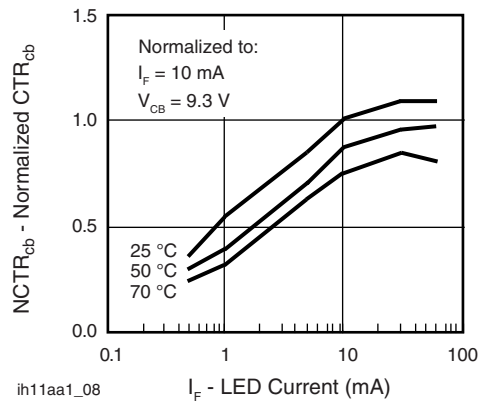

Fig. 8 - Normalized  $CTR_{cb}$  vs. LED Current and Temperature



Fig. 11 - Normalized Saturated  $h_{FE}$  vs. Base Current and Temperature

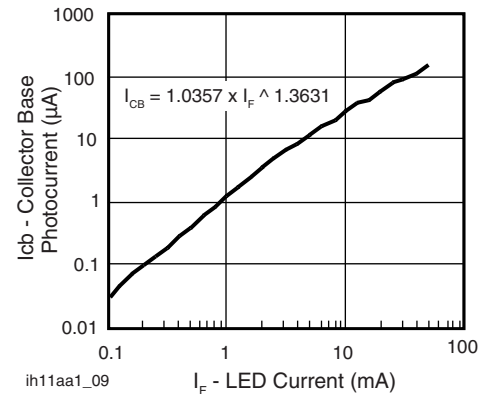

Fig. 9 - Collector Base Photocurrent vs. LED Current

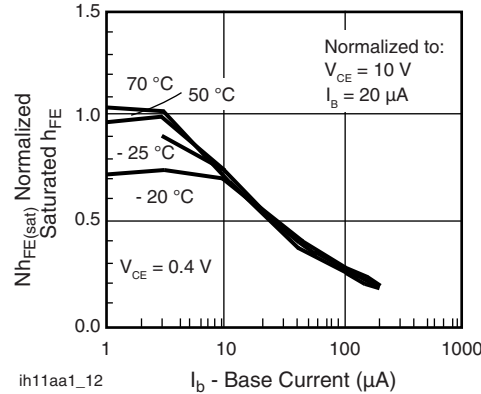

Fig. 12 - Normalized Saturated  $h_{FE}$  vs. Base Current and Temperature



Fig. 13 - Propagation Delay vs. Collector Load Resistor



ih11aa1\_14

Fig. 14 - Switching Waveform



ih11aa1\_15

Fig. 15 - Switching Schematic

# H11AA1



Vishay Semiconductors Optocoupler, Phototransistor Output,  
AC Input, with Base Connection

## PACKAGE DIMENSIONS in millimeters

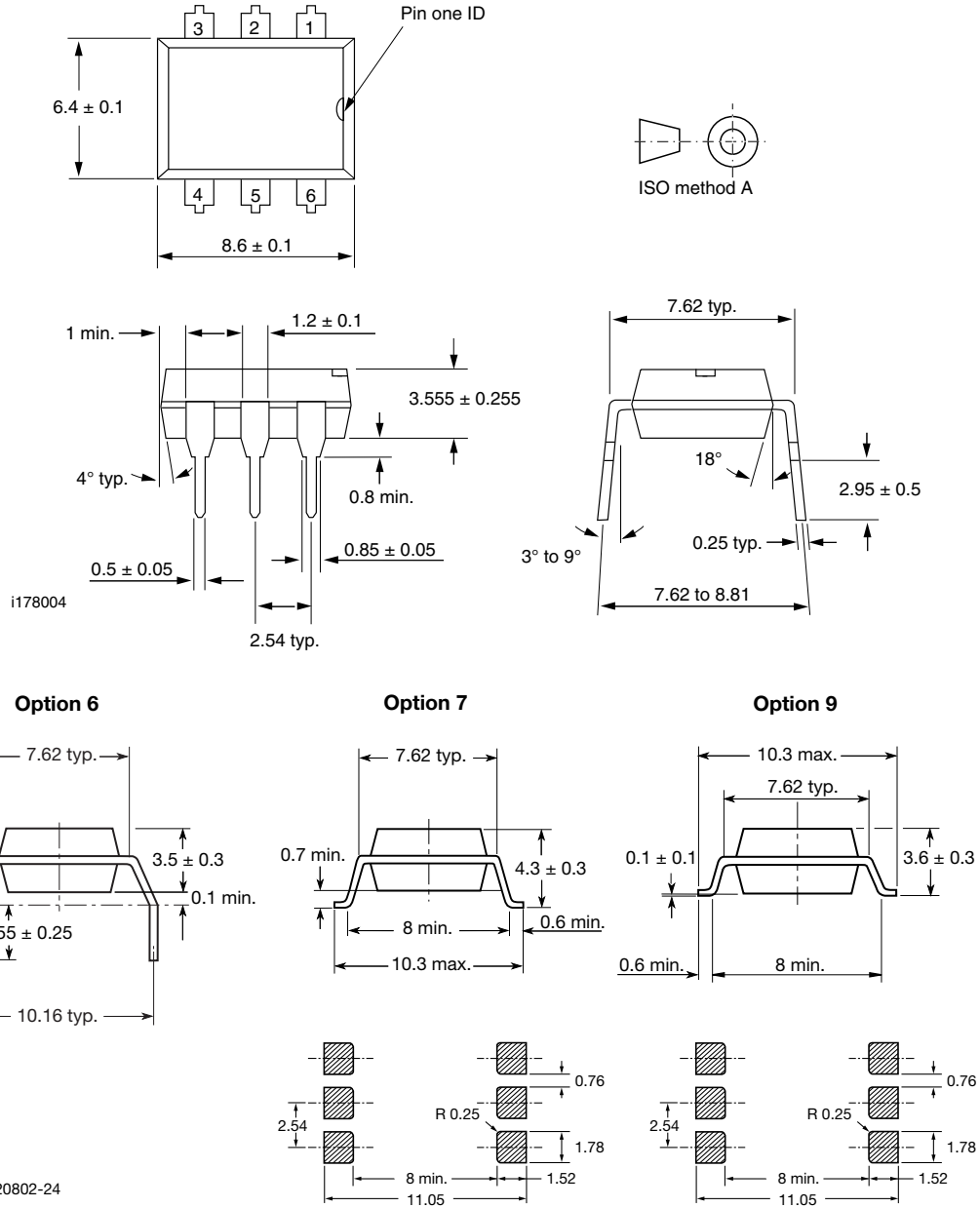

## PACKAGE MARKING

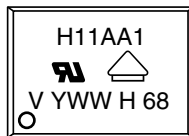

### Notes

- Only options 1 and 7 are reflected in the package marking.
- The VDE Logo is only marked on option1 parts.
- Tape and reel suffix (T) is not part of the package marking.



## Disclaimer

ALL PRODUCT, PRODUCT SPECIFICATIONS AND DATA ARE SUBJECT TO CHANGE WITHOUT NOTICE TO IMPROVE RELIABILITY, FUNCTION OR DESIGN OR OTHERWISE.

Vishay Intertechnology, Inc., its affiliates, agents, and employees, and all persons acting on its or their behalf (collectively, "Vishay"), disclaim any and all liability for any errors, inaccuracies or incompleteness contained in any datasheet or in any other disclosure relating to any product.

Vishay makes no warranty, representation or guarantee regarding the suitability of the products for any particular purpose or the continuing production of any product. To the maximum extent permitted by applicable law, Vishay disclaims (i) any and all liability arising out of the application or use of any product, (ii) any and all liability, including without limitation special, consequential or incidental damages, and (iii) any and all implied warranties, including warranties of fitness for particular purpose, non-infringement and merchantability.

Statements regarding the suitability of products for certain types of applications are based on Vishay's knowledge of typical requirements that are often placed on Vishay products in generic applications. Such statements are not binding statements about the suitability of products for a particular application. It is the customer's responsibility to validate that a particular product with the properties described in the product specification is suitable for use in a particular application. Parameters provided in datasheets and/or specifications may vary in different applications and performance may vary over time. All operating parameters, including typical parameters, must be validated for each customer application by the customer's technical experts. Product specifications do not expand or otherwise modify Vishay's terms and conditions of purchase, including but not limited to the warranty expressed therein.

Except as expressly indicated in writing, Vishay products are not designed for use in medical, life-saving, or life-sustaining applications or for any other application in which the failure of the Vishay product could result in personal injury or death. Customers using or selling Vishay products not expressly indicated for use in such applications do so at their own risk. Please contact authorized Vishay personnel to obtain written terms and conditions regarding products designed for such applications.

No license, express or implied, by estoppel or otherwise, to any intellectual property rights is granted by this document or by any conduct of Vishay. Product names and markings noted herein may be trademarks of their respective owners.

## Material Category Policy

**Vishay Intertechnology, Inc. hereby certifies that all its products that are identified as RoHS-Compliant fulfill the definitions and restrictions defined under Directive 2011/65/EU of The European Parliament and of the Council of June 8, 2011 on the restriction of the use of certain hazardous substances in electrical and electronic equipment (EEE) - recast, unless otherwise specified as non-compliant.**

**Please note that some Vishay documentation may still make reference to RoHS Directive 2002/95/EC. We confirm that all the products identified as being compliant to Directive 2002/95/EC conform to Directive 2011/65/EU.**

**Vishay Intertechnology, Inc. hereby certifies that all its products that are identified as Halogen-Free follow Halogen-Free requirements as per JEDEC JS709A standards. Please note that some Vishay documentation may still make reference to the IEC 61249-2-21 definition. We confirm that all the products identified as being compliant to IEC 61249-2-21 conform to JEDEC JS709A standards.**