



GaAs PHEMT MMIC 1 WATT POWER AMPLIFIER, 6.0 - 9.5 GHz

Typical Applications

The HMC590LP5 / HMC590LP5E is ideal for use as a power amplifier for:

- Point-to-Point Radios
- Point-to-Multi-Point Radios
- Test Equipment & Sensors
- Military End-Use
- Space

Features

- Saturated Output Power: +31.5 dBm @ 23% PAE
- Output IP3: +40 dBm
- Gain: 21 dB
- DC Supply: +7V @ 820 mA
- 50 Ohm Matched Input/Output
- QFN Leadless SMT Packages, 25 mm²

Functional Diagram

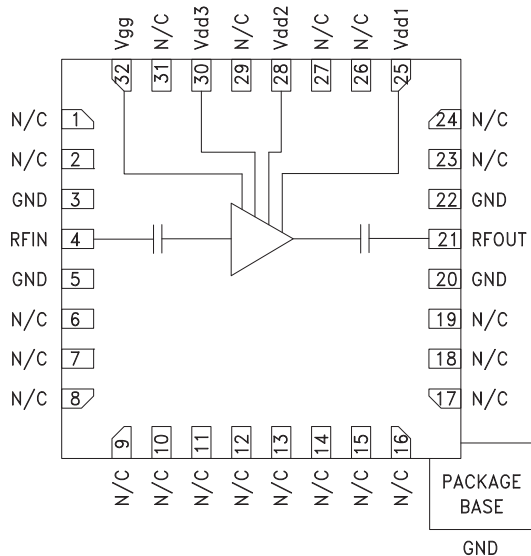

General Description

The HMC590LP5 & HMC590LP5E are high dynamic range GaAs PHEMT MMIC 1 Watt Power Amplifiers which operate from 6 to 9.5 GHz. The amplifier provides 21 dB of gain, +31 dBm of saturated power, and 23% PAE from a +7V supply. This 50 Ohm matched amplifier does not require any external components and the RF I/Os are DC blocked for robust operation. For applications which require optimum OIP3, I_{dd} should be set for 520 mA, to yield +40 dBm OIP3. For applications which require optimum output P1dB, I_{dd} should be set for 820 mA, to yield +30 dBm Out-put P1dB.

Electrical Specifications, T_A = +25° C, V_{dd} = +7V, I_{dd} = 820 mA^[1]

Parameter	Min.	Typ.	Max.	Min.	Typ.	Max.	Units
Frequency Range	6 - 8		6 - 9.5				GHz
Gain	18	21		18	21		dB
Gain Variation Over Temperature		0.05			0.05		dB/ °C
Input Return Loss		15			12		dB
Output Return Loss		11			10		dB
Output Power for 1 dB Compression (P1dB)	27	30		27.5	30.5		dBm
Saturated Output Power (Psat)		30.5			31		dBm
Output Third Order Intercept (IP3) ^[2]		40			40		dBm
Supply Current (I _{dd})		820			820		mA

[1] Adjust V_{gg} between -2 to 0V to achieve I_{dd}= 820 mA typical.

[2] Measurement taken at 7V @ 520mA, Pin/Tone = -15 dBm



Broadband Gain & Return Loss

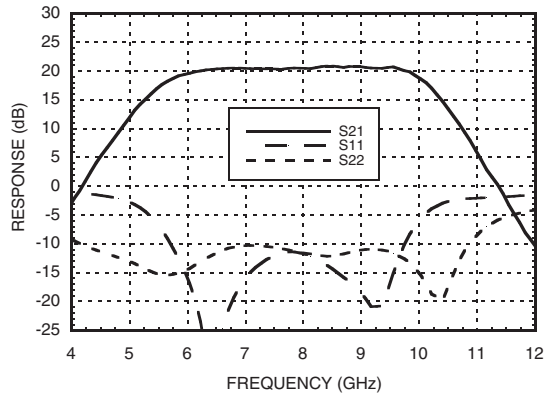

Gain vs. Temperature

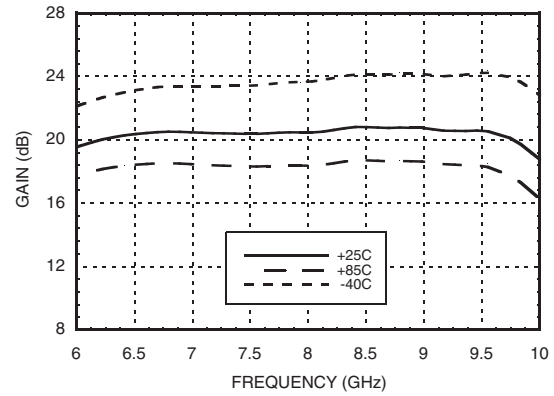

Input Return Loss vs. Temperature

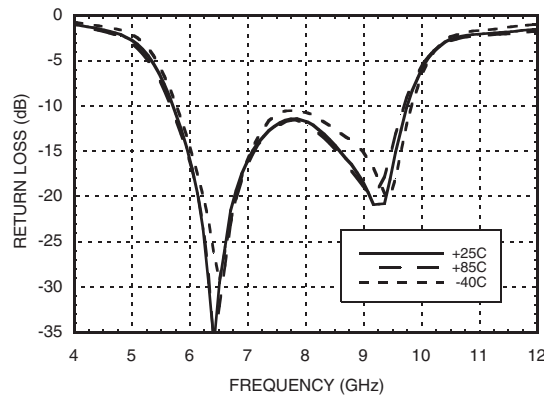

Output Return Loss vs. Temperature

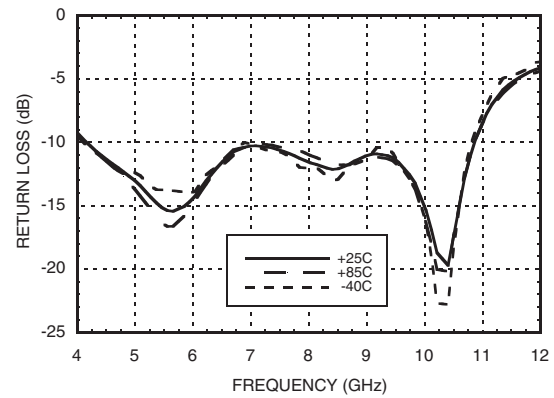

P1dB vs. Temperature

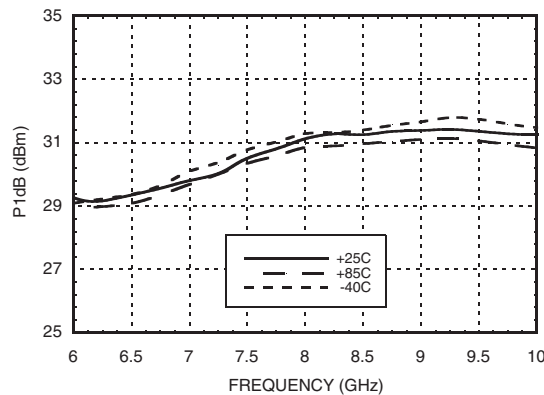

Psat vs. Temperature

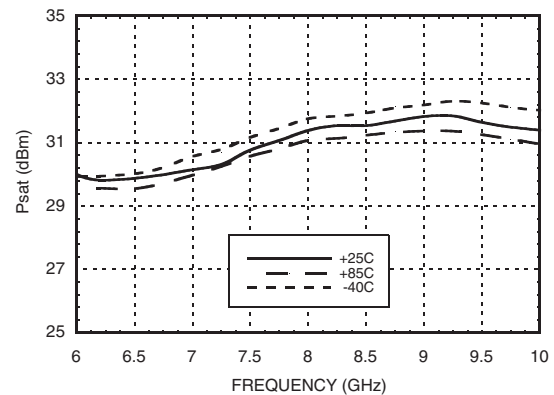

11

LINEAR & POWER AMPLIFIERS - SMT

P1dB vs. Current

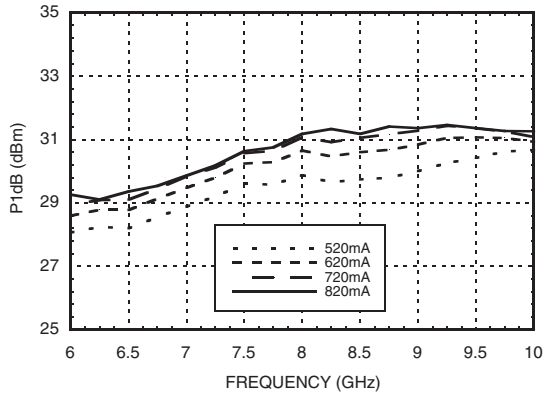

Psat vs. Current

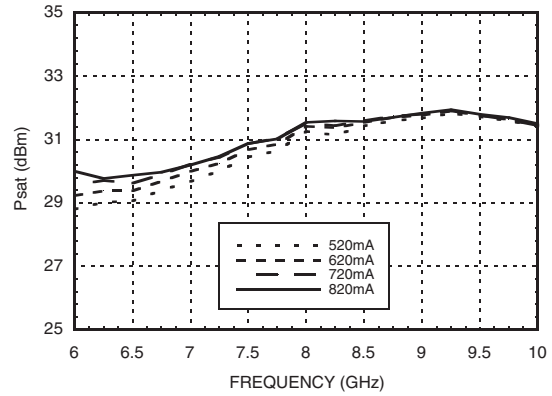

Output IP3 vs. Temperature
7V @ 520 mA, Pin/Tone = -15 dBm

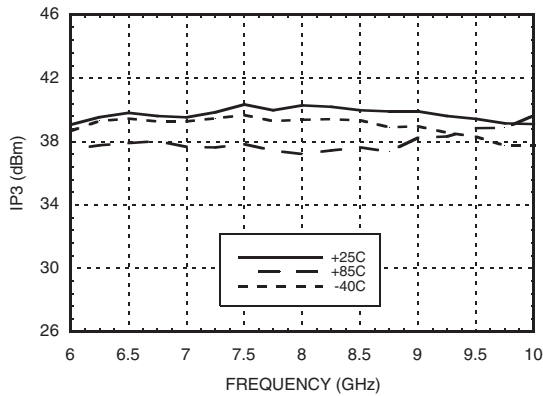

Power Compression @ 8 GHz,
7V @ 820 mA

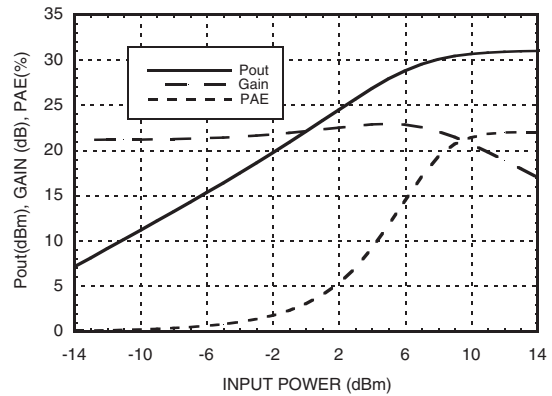

Output IM3, 7V @ 520 mA

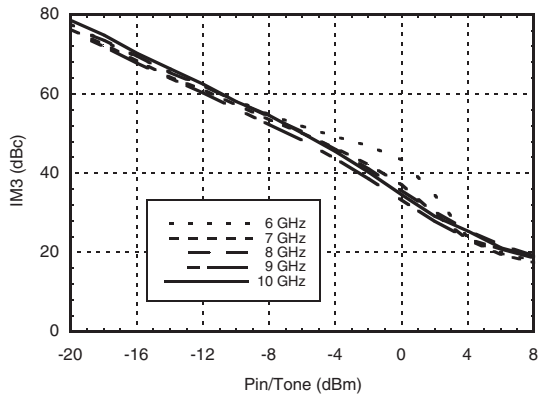

Output IM3, 7V @ 820 mA

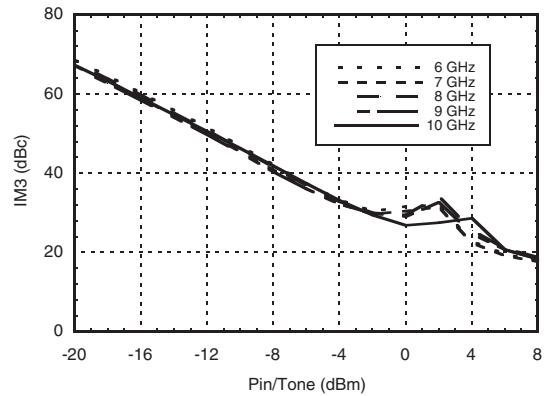



Gain & Power vs. Supply Current @ 8 GHz

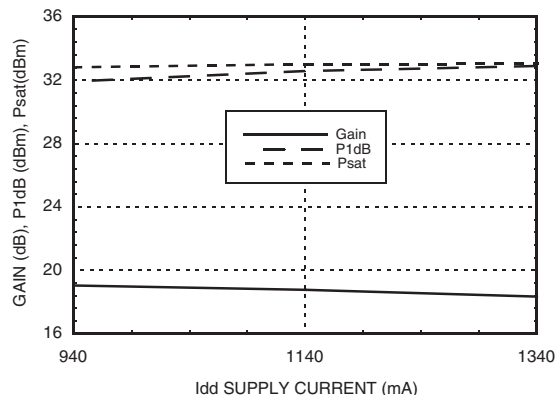

Gain & Power vs. Supply Voltage @ 8 GHz

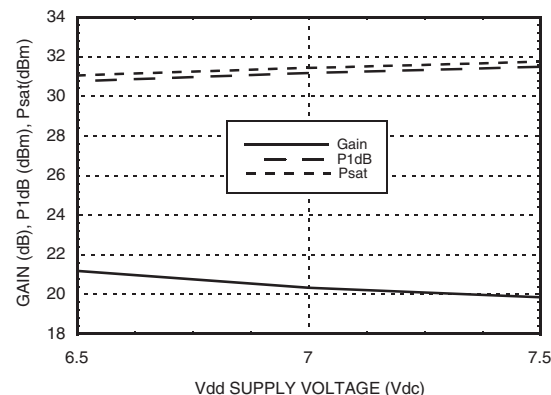

Reverse Isolation vs. Temperature, 7V @ 820 mA

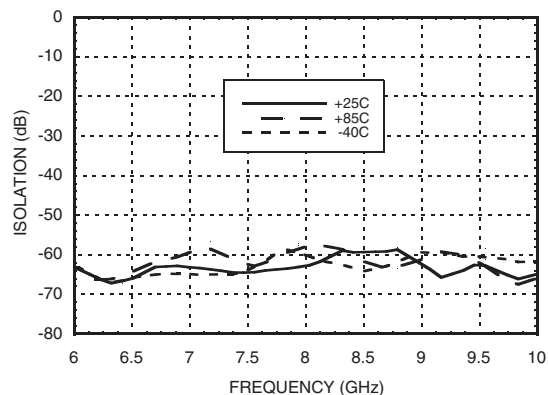

Power Dissipation

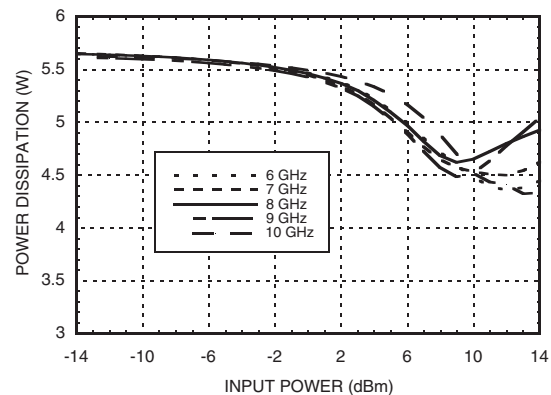

Absolute Maximum Ratings

Drain Bias Voltage (Vdd)	+8 Vdc
Gate Bias Voltage (Vgg)	-2.0 to 0 Vdc
RF Input Power (RFIN)(Vdd = +7.0 Vdc)	+12 dBm
Channel Temperature	175 °C
Continuous Pdiss (T= 75 °C) (derate 59.8 mW/°C above 75 °C)	5.98 W
Thermal Resistance (channel to package bottom)	16.72 °C/W
Storage Temperature	-65 to +150 °C
Operating Temperature	-55 to +85 °C

Typical Supply Current vs. Vdd

Vdd (V)	Idd (mA)
+6.5	824
+7.0	820
+7.5	815

Note: Amplifier will operate over full voltage ranges shown above Vgg adjusted to achieve Idd = 820 mA at +7.0V



ELECTROSTATIC SENSITIVE DEVICE
OBSERVE HANDLING PRECAUTIONS

Outline Drawing

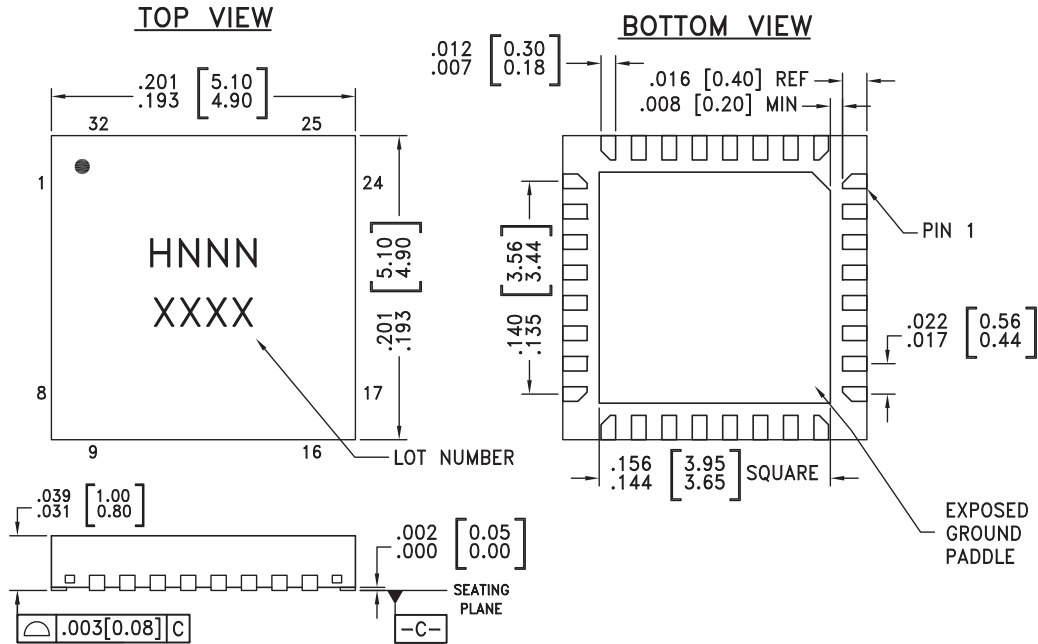

NOTES:

1. LEADFRAME MATERIAL: COPPER ALLOY
2. DIMENSIONS ARE IN INCHES [MILLIMETERS]
3. LEAD SPACING TOLERANCE IS NON-CUMULATIVE
4. PAD BURR LENGTH SHALL BE 0.15mm MAXIMUM.
PAD BURR HEIGHT SHALL BE 0.05mm MAXIMUM.
5. PACKAGE WARP SHALL NOT EXCEED 0.05mm.
6. ALL GROUND LEADS AND GROUND PADDLE MUST BE SOLDERED TO PCB RF GROUND.
7. REFER TO HITTITE APPLICATION NOTE FOR SUGGESTED LAND PATTERN.

Package Information

Part Number	Package Body Material	Lead Finish	MSL Rating	Package Marking ^[3]
HMC590LP5	Low Stress Injection Molded Plastic	Sn/Pb Solder	MSL1 ^[1]	H590 XXXX
HMC590LP5E	RoHS-compliant Low Stress Injection Molded Plastic	100% matte Sn	MSL1 ^[2]	H590 XXXX

[1] Max peak reflow temperature of 235 °C

[2] Max peak reflow temperature of 260 °C

[3] 4-Digit lot number XXXX

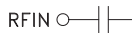
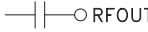
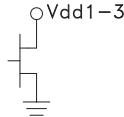
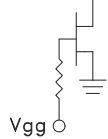

Pin Descriptions

Pin Number	Function	Description	Interface Schematic
1, 2, 6 - 19, 23, 24, 26, 27, 29, 31	N/C	Not connected.	
3, 5, 20, 22	GND	These pins and package bottom must be connected to RF/DC ground.	
4	RFIN	This pad is AC coupled and matched to 50 Ohms.	
21	RFOUT	This pad is AC coupled and matched to 50 Ohms.	
25, 28, 30	Vdd 1-3	Power Supply Voltage for the amplifier. External bypass capacitors of 100 pF and 2.2 μF are required.	
32	Vgg	Gate control for amplifier. Adjust to achieve I _{dd} of 820 mA. Please follow "MMIC Amplifier Biasing Procedure" Application Note. External bypass capacitors of 100 pF and 2.2 μF are required.	



Application Circuit

Component	Value
C1 - C4	100pF
C5 - C8	2.2μF

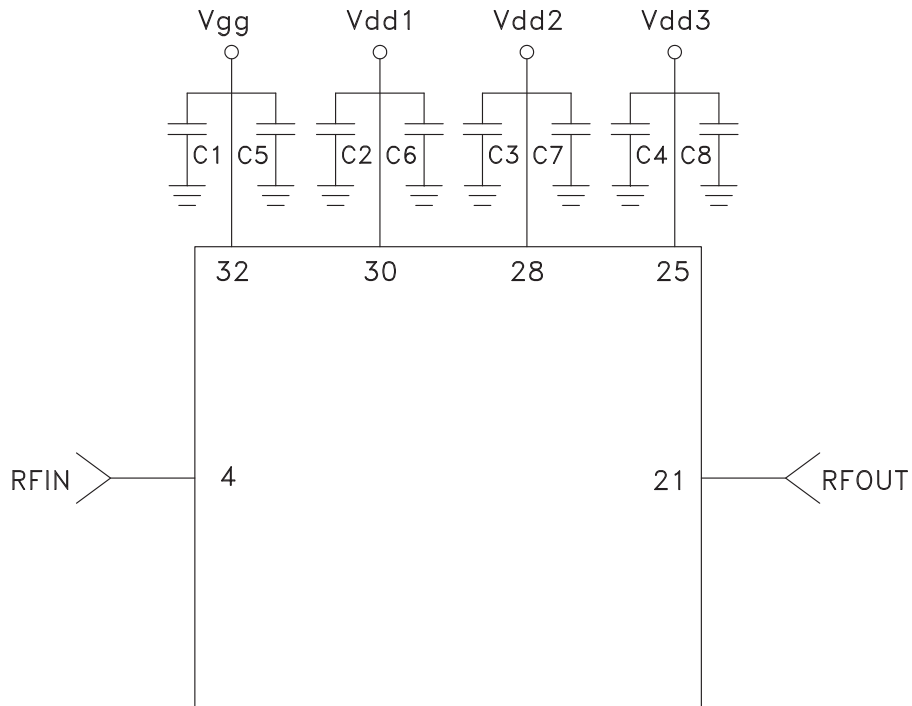

Evaluation PCB

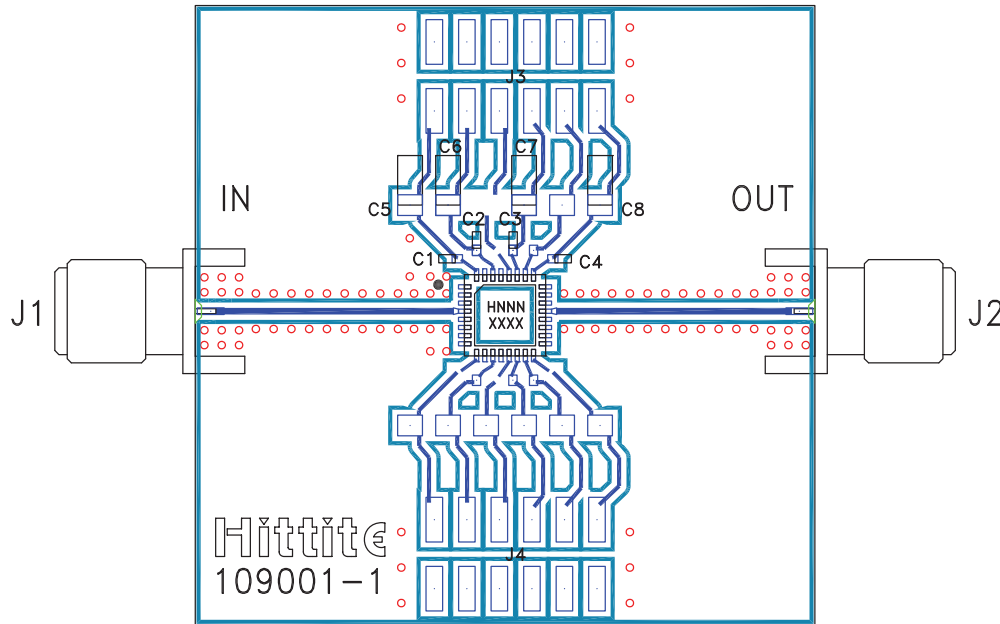

List of Materials for Evaluation PCB 115927 [1]

Item	Description
J1 - J2	PCB Mount SMA Connector
J3	DC Pin
C1 - C4	100 pF Capacitor, 0402 Pkg
C5 - C8	2.2 μF Capacitor, 1206 Pkg
U1	HMC590LP5 / HMC590LP5E
PCB [2]	109001 Evaluation PCB

[1] Reference this number when ordering complete evaluation PCB

[2] Circuit Board Material: Rogers 4350

The circuit board used in the final application should use RF circuit design techniques. Signal lines should have 50 ohm impedance while the package ground leads and package bottom should be connected directly to the ground plane similar to that shown. A sufficient number of via holes should be used to connect the top and bottom ground planes. The evaluation board should be mounted to an appropriate heat sink. The evaluation circuit board shown is available from Hittite upon request.