

WIDE BAND 3-INPUT 1-OUTPUT 3-CIRCUIT VIDEO AMPLIFIER

■GENERAL DESCRIPTION

The **NJM2585** is a wide band 3-input 1-output 3-circuit video amplifier. It is suitable for Y, Pb, and Pr signal because frequency range is 50MHz.

The **NJM2585** is suitable for AV receiver, STB, and other high quality AV systems.

■ FEATURES

- Operating Voltage 4.5 to 9.0V
- Wide frequency range 0dB at 50MHz typ.
- Internal 3 input-1output 3-circuit video switch
- Internal 6dB Amplifier
- Internal 75Ω Driver Circuit
- Power Save Circuit
- Bipolar Technology
- Package Outline DMP24, SDIP22

■PACKAGE OUTLINE

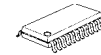

NJM2585M

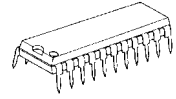

NJM2585L

■BLOCK DIAGRAM

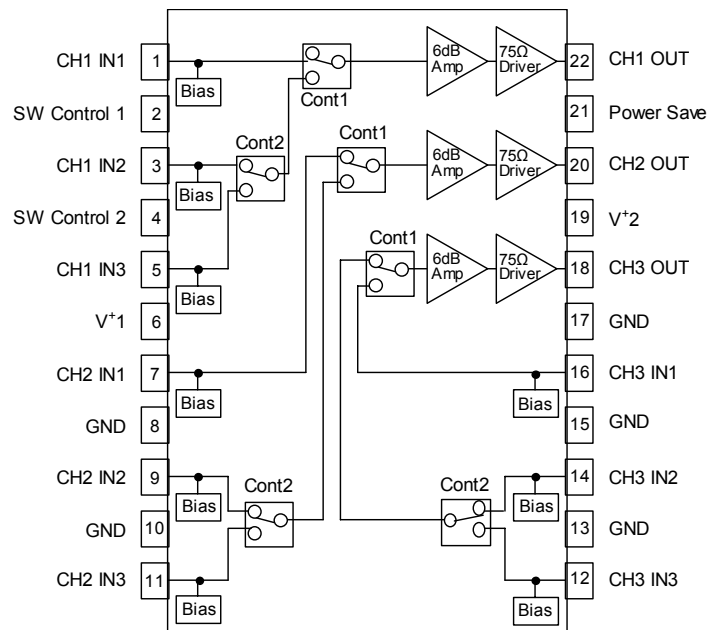
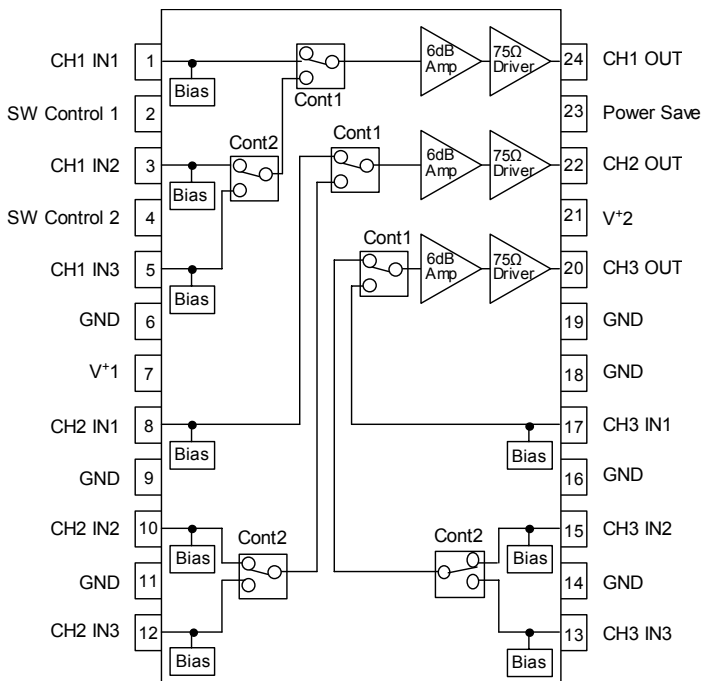

■ABSOLUTE MAXIMUM RATINGS (Ta=25°C)

PARAMETER	SYMBOL	RATINGS	UNIT
Supply Voltage	V ⁺	12.0	V
Power Dissipation	P _D	500 (DMP24) 700 (SDIP22)	mW
Operating Temperature Range	Topr	-40 to +85	°C
Storage Temperature Range	Tstg	-40 to +125	°C

■ELECTRICAL CHARACTERISTICS (Ta=25°C, V⁺1=5V, V⁺2=5V, R_L=150Ω)

PARAMETER	SYMBOL	TEST CONDITION	MIN.	TYP.	MAX.	UNIT
Operating Current	I _{CC}	No Signal	-	23.0	35.0	mA
Operating Current at Power Save	I _{save}	No Signal, Power Save Mode	-	0.7	1.2	mA
Maximum Output Voltage Swing	V _{om}	V _{in} =100kHz, Sine Signal, THD=1%	2.4	3.0	-	V _{p-p}
Voltage Gain	G _v	V _{in} =1MHz, 1.0V _{p-p} , Sine Signal	5.8	6.2	6.6	dB
Gain Difference Between Channel	ΔG _{vI}	V _{in} =1MHz, 1.0V _{p-p} , Sine Signal (IN1, IN2, IN3)	-0.2	0	+0.2	dB
Gain Difference Between Block	ΔG _{vB}	V _{in} =1MHz, 1.0V _{p-p} , Sine Signal (CH1, CH2, CH3)	-0.2	0	+0.2	dB
Band Width	f		-	50	-	MHz
Frequency Characteristic	G _f	V _{in} =50MHz/1MHz, 1.0V _{p-p} , Sine signal	-	0	-	dB
Channel Cross talk 1	CTI1	V _{in} =4.43MHz, 1.0V _{p-p} , Sine signal	-	-60	-50	dB
Channel Cross talk 2	CTI2	V _{in} =50MHz, 1.0V _{p-p} , Sine signal	-	-40	-	dB
Block Cross talk 1	CTB1	V _{in} =4.43MHz, 1.0V _{p-p} , Sine signal	-	-60	-50	dB
Block Cross talk 2	CTB2	V _{in} =50MHz, 1.0V _{p-p} , Sine signal	-	-40	-	dB
Differential Gain	DG	V _{in} =1.0V _{p-p} , 10step Video Signal	-	0.3	-	%
Differential Phase	DP	V _{in} =1.0V _{p-p} , 10step Video Signal	-	0.3	-	deg
S/N Ratio	SN _v	V _{in} =1.0V _{p-p} , 100KHz to 6MHz 100% White Video Signal	-	65	-	dB
Power Save SW Change Voltage High Level	V _{thPH}	PS	2.0	-	V ⁺	V
Power Save SW Change Voltage Low Level	V _{thPL}	PS	0	-	0.6	V
Input Select SW Change Voltage High Level	V _{thSH}	SW1, SW2	2.0	-	V ⁺	V
Input Select SW Change Voltage Low Level	V _{thSL}	SW1, SW2	0	-	0.6	V

■CONTROL TERMINAL

PARAMETER	STATUS	NOTE
Power Save	H	Power Save: OFF
	L	Power Save: ON
	OPEN	Power Save: ON

PARAMETER	STATUS		NOTE
SW Control	SW1	SW2	
	L, OPEN	X	IN1 (X=don't care)
	H	L, OPEN	IN2
	H	H	IN3

■ TERMINAL FUNCTION

PIN NO.	PIN NAME	EQUIVALENT CIRCUIT	DC VOLTAGE (V+=5V)	NOTE
1 3 5 8 10 12 13 15 17	CH1IN1 CH1IN2 CH1IN3 CH2IN1 CH2IN2 CH2IN3 CH3IN1 CH3IN2 CH3IN3		2.5V	
20 22 24	CH3OUT CH2OUT CH1OUT		2.5V	
2 4	SW1 SW2		0V	
23	PowerSave		0V	

TEST CIRCUIT

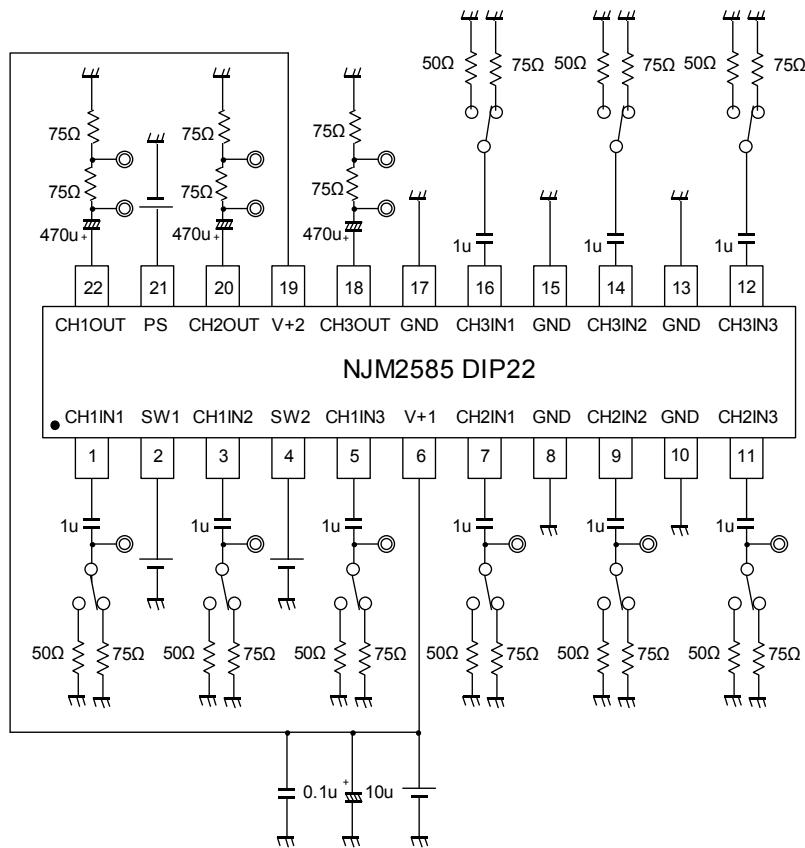
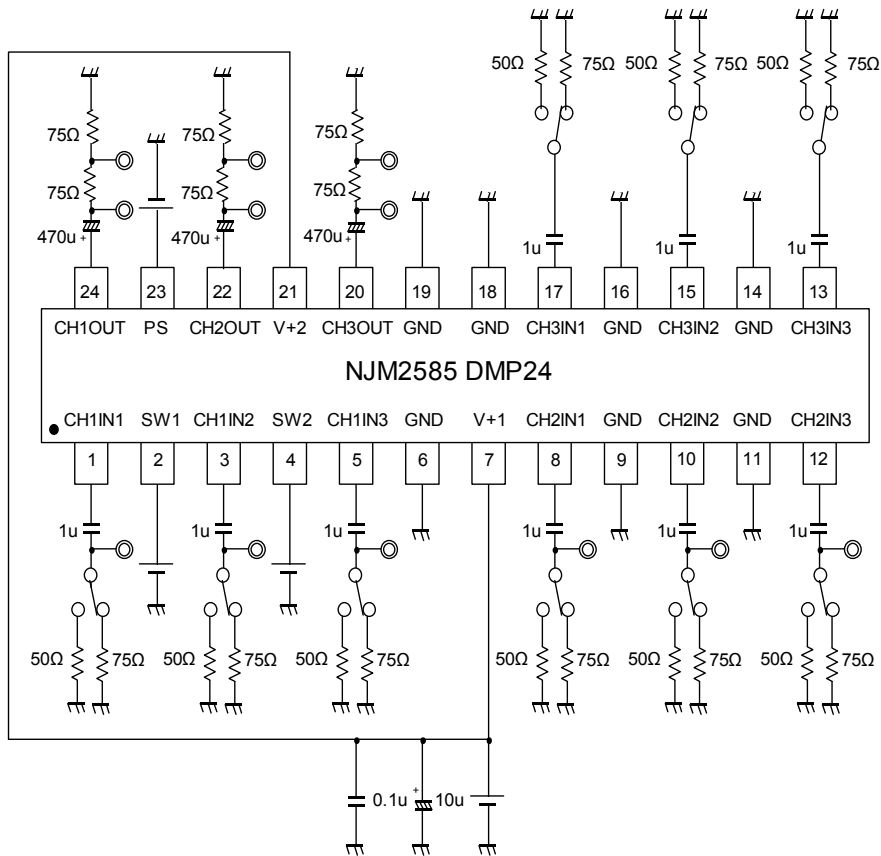

NOTE

Please ground all GND terminals.

■APPLICATION CIRCUIT

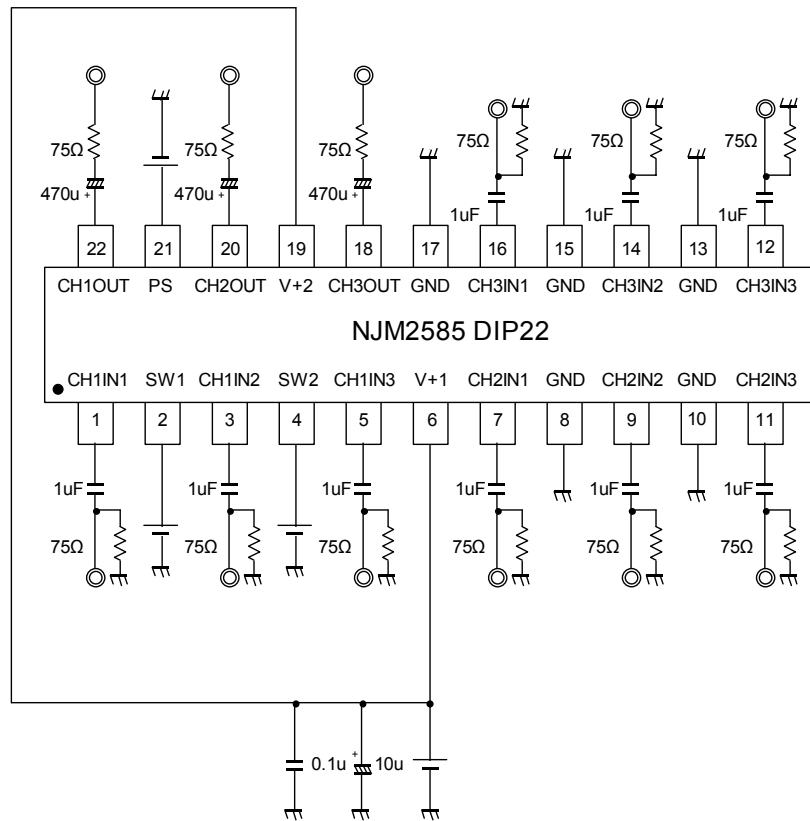
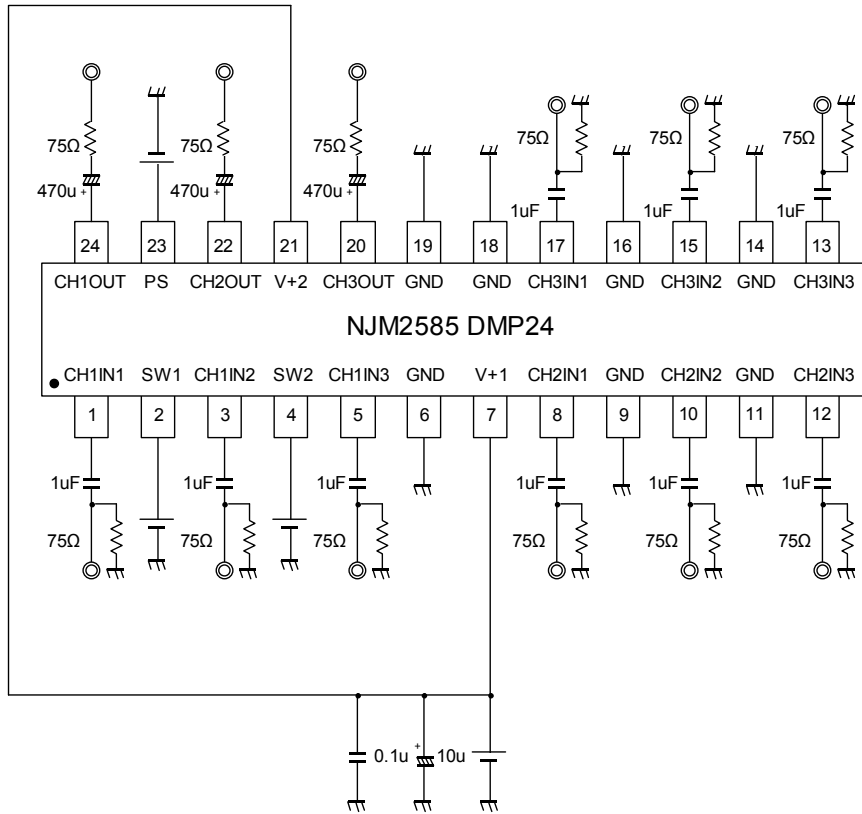

■NOTE
Please ground all GND terminals.

■ TYPICAL CHARACTERISTICS

Voltage Gain vs Frequency

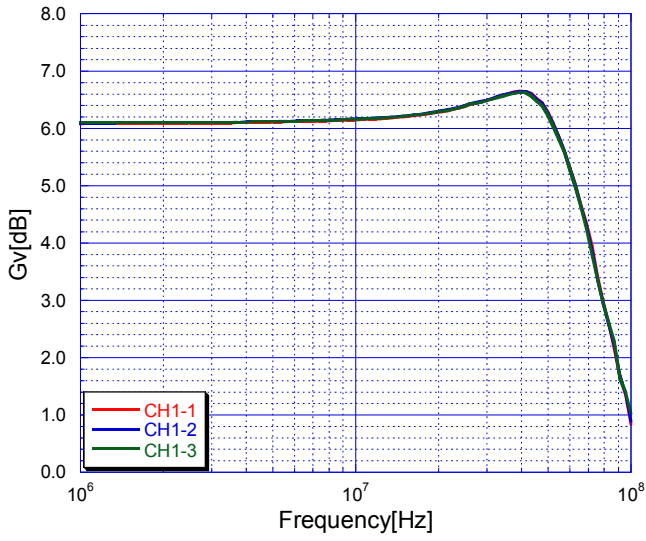

V vs Icc

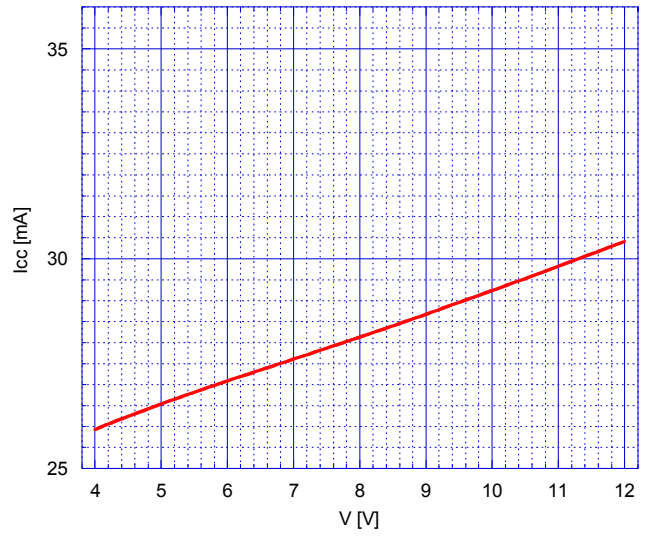

V vs Isave

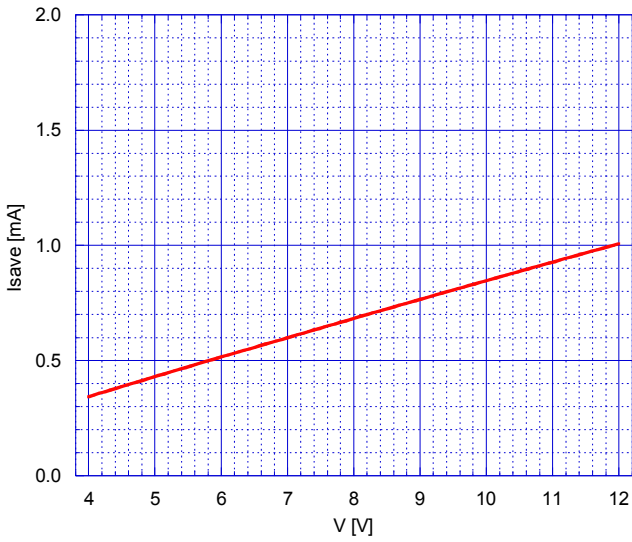

V vs Vom

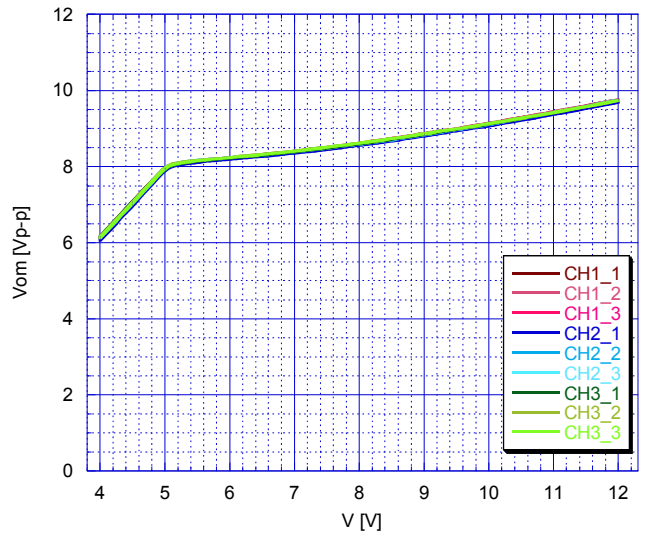

V vs Gv

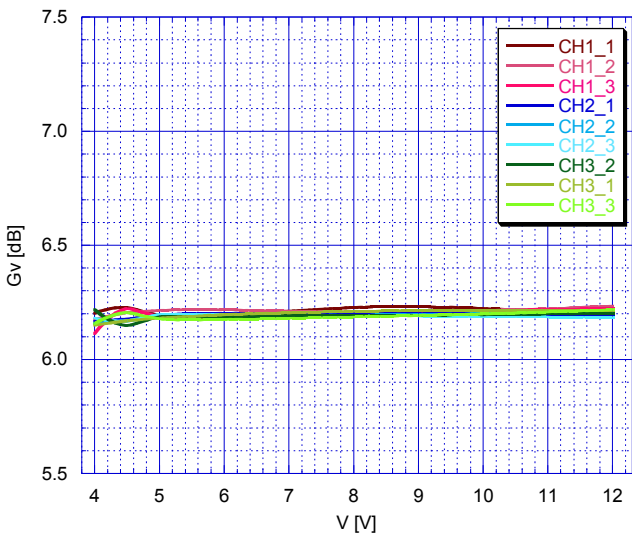

V vs dGvI

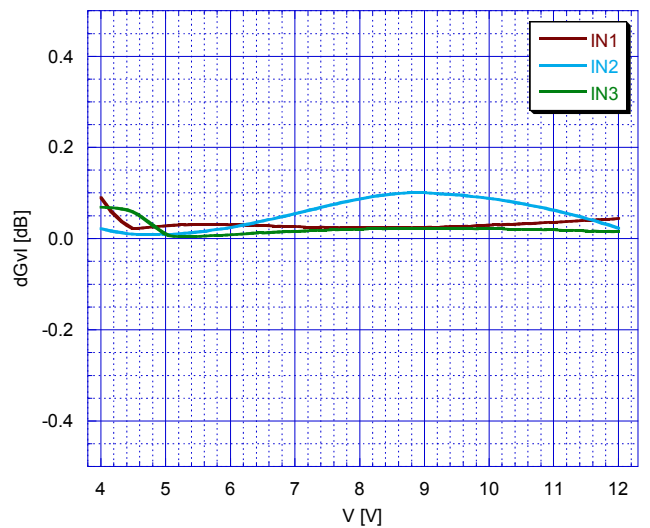

V vs dGvB

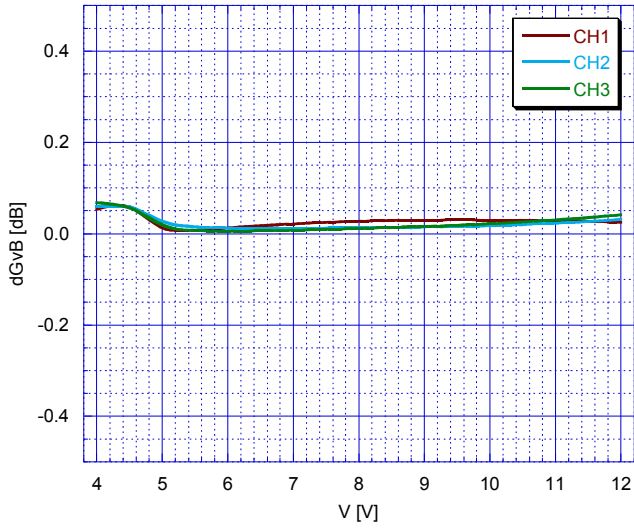

V vs Gf

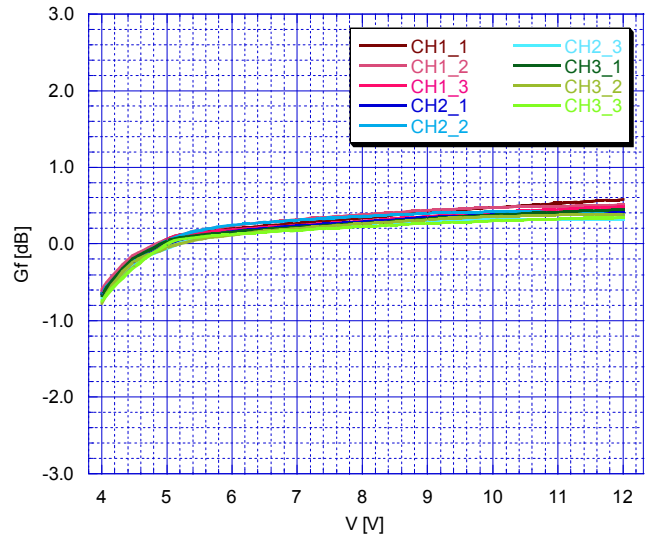

V vs CT- I1

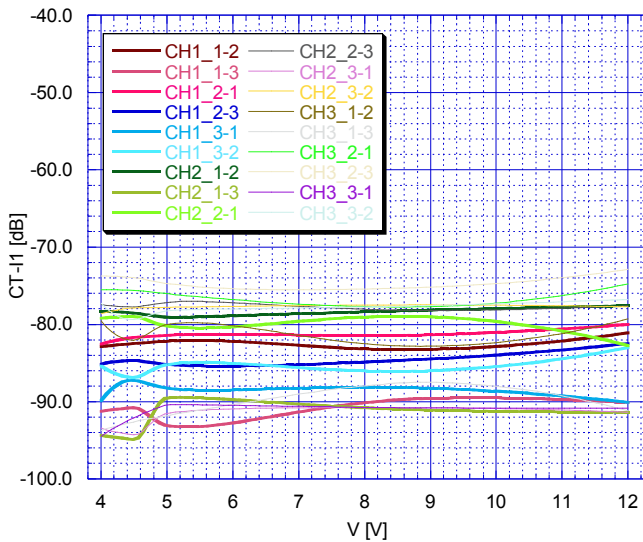

V vs CT- I2

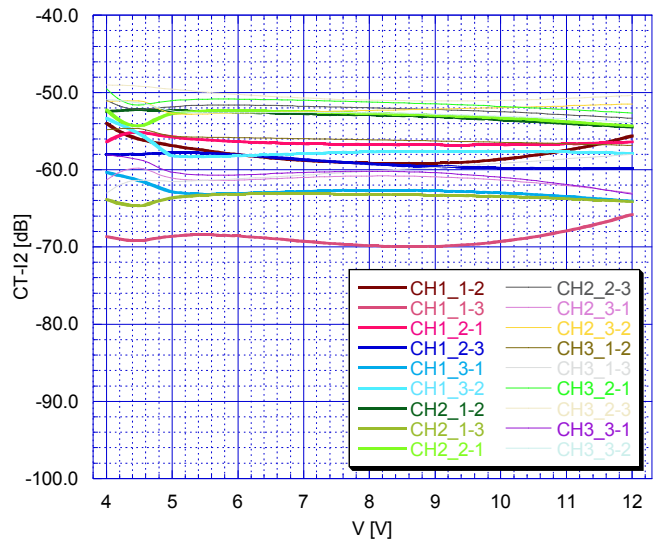

V vs CT- B1

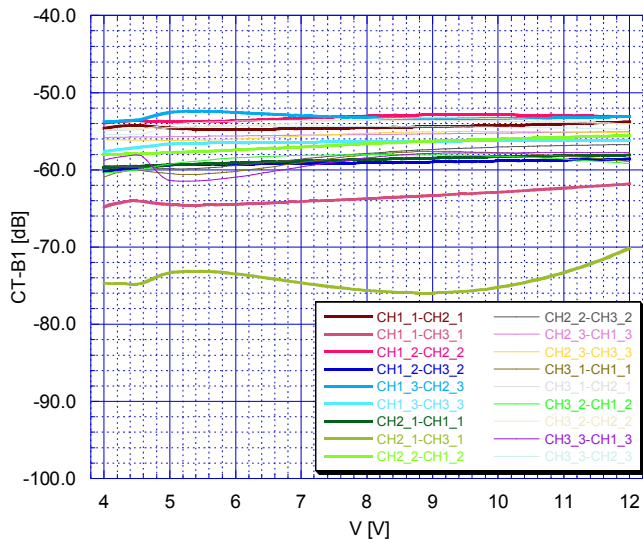

V vs CT- B2

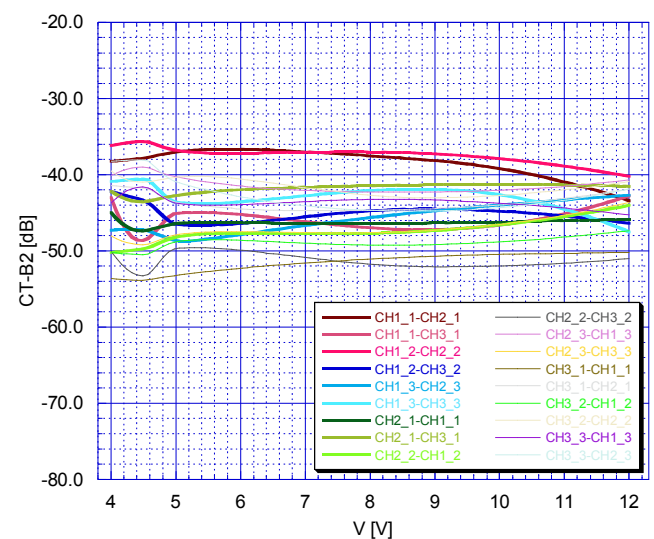

V vs DG

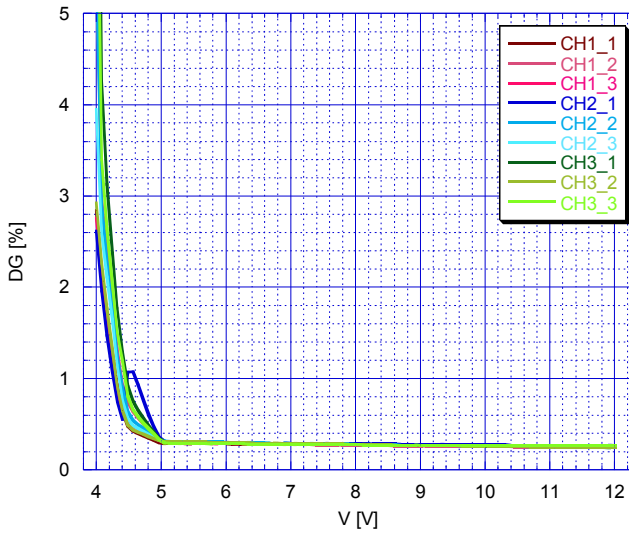

V vs DP

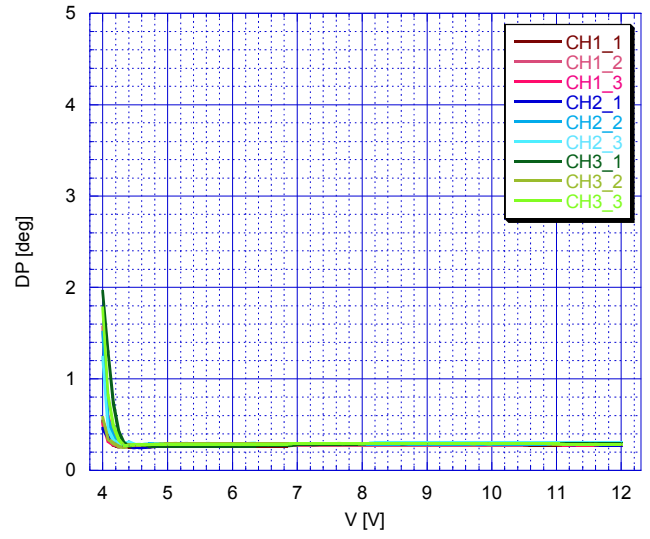

V vs SN

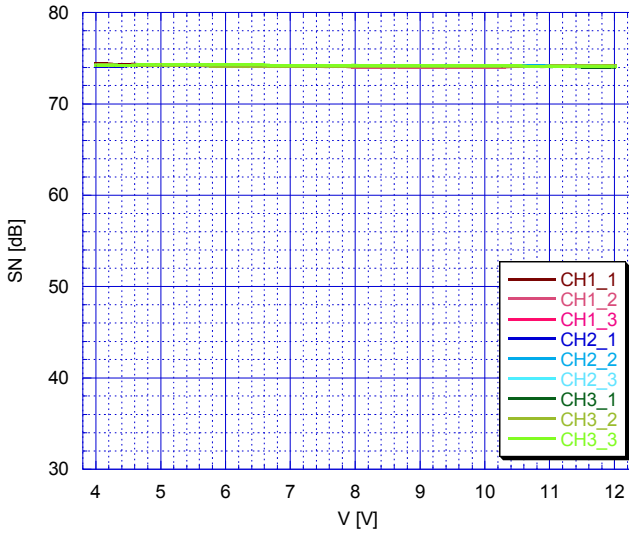

V vs VthSH

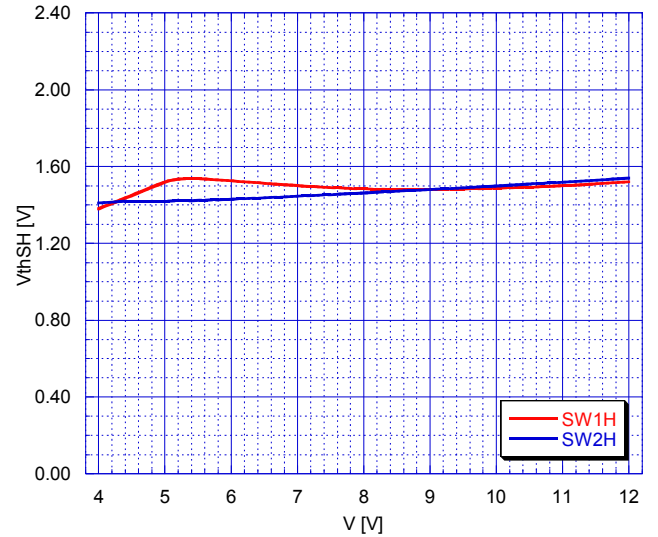

V vs VthSL

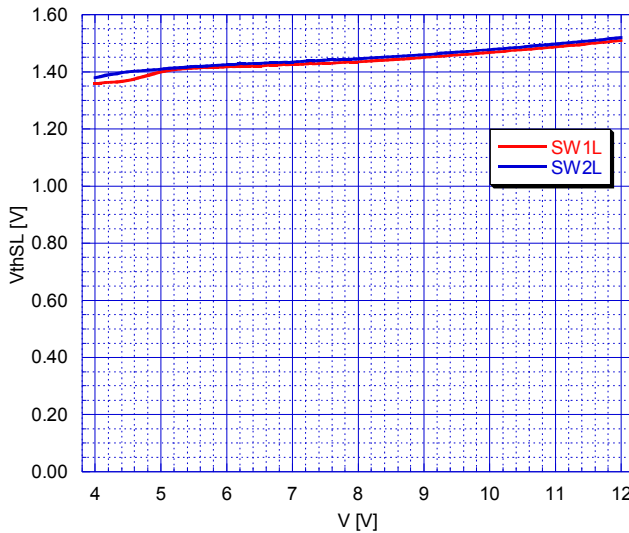

V vs VthPH

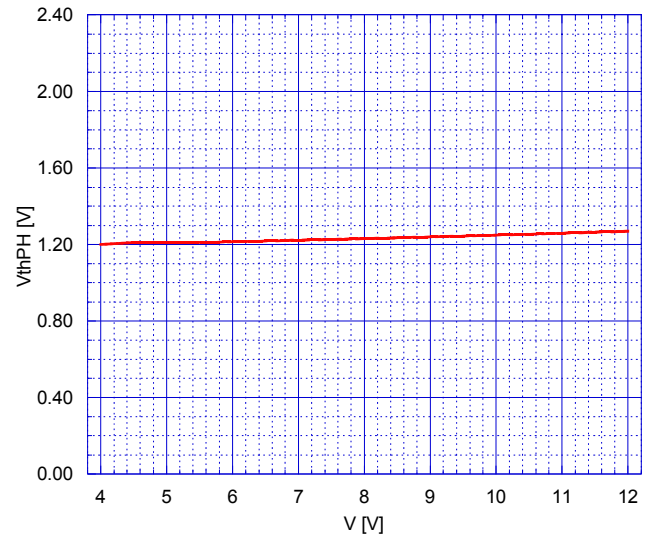

V vs VthPL

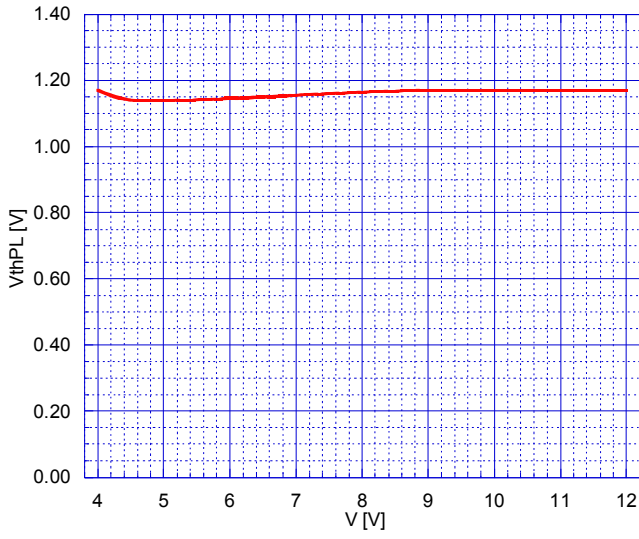

T vs Icc

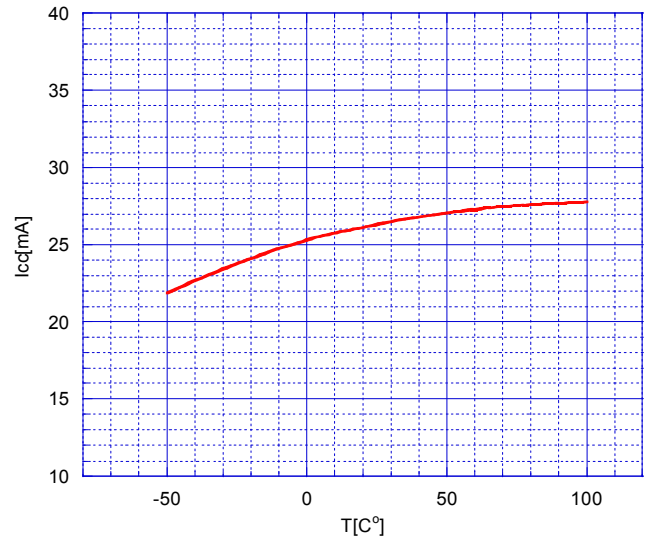

T vs Isave

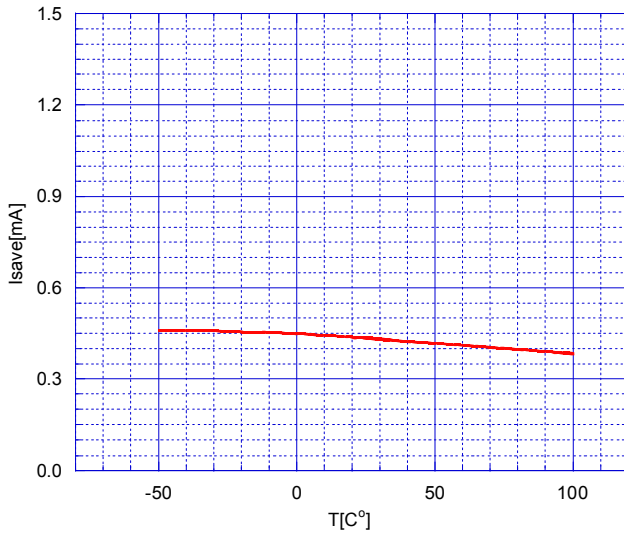

T vs Vom

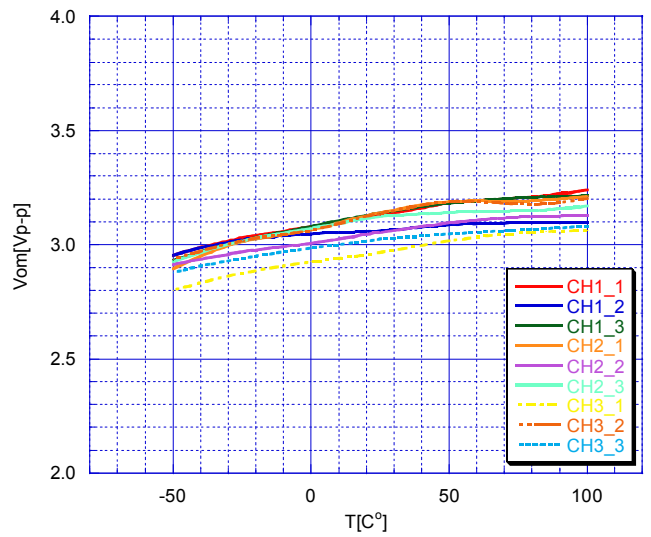

T vs Gv

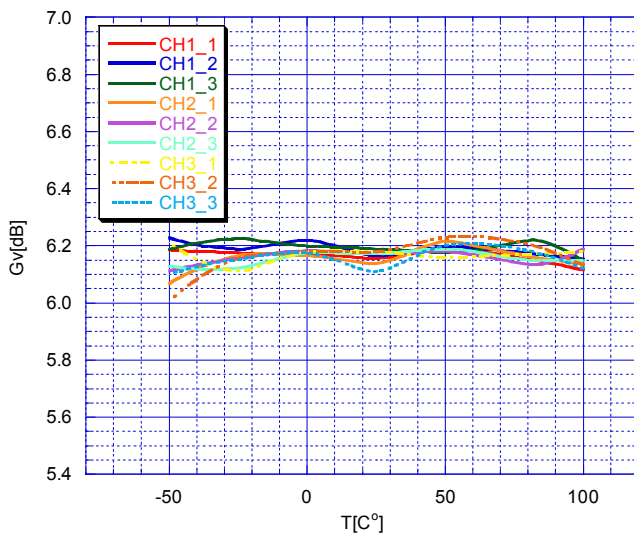

T vs dGvI

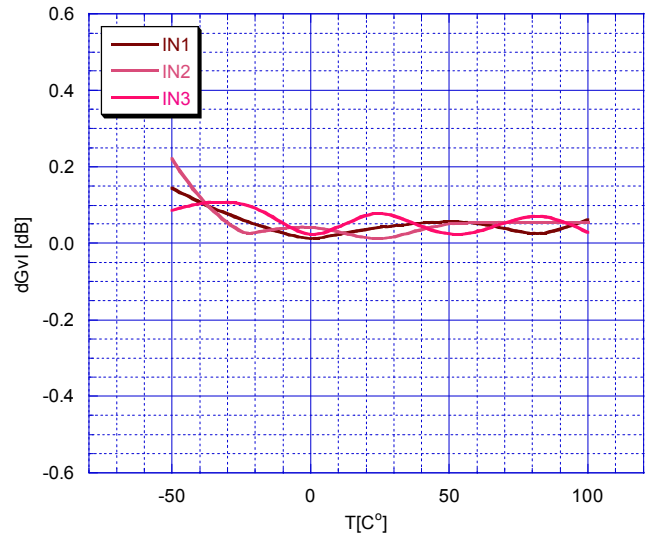

T vs dGvB

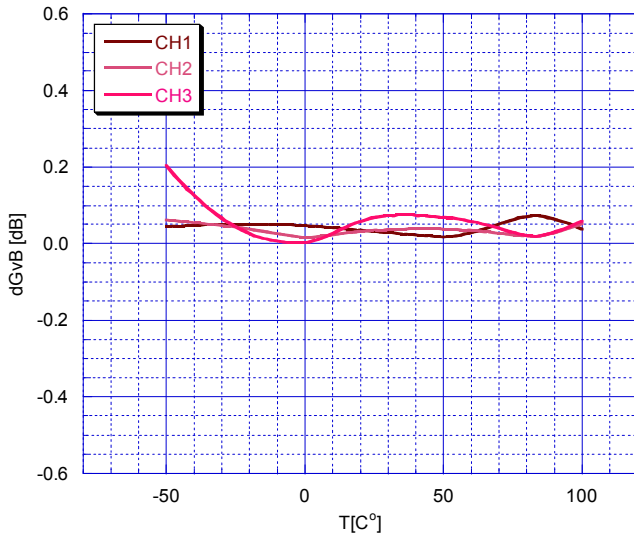

T vs Gf

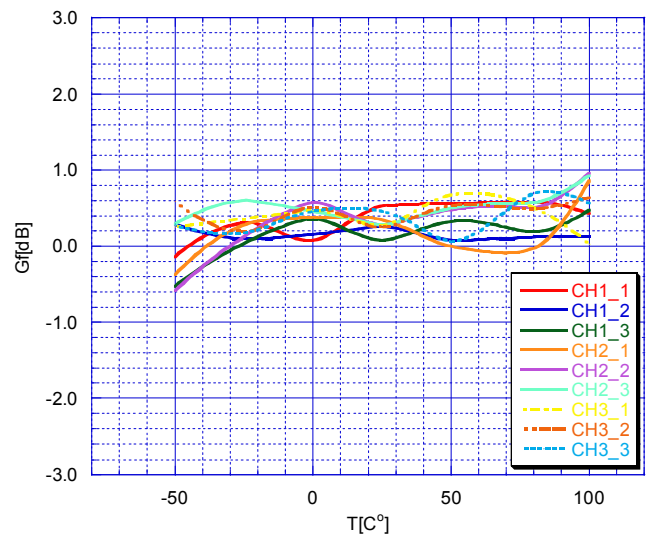

T vs CTI1

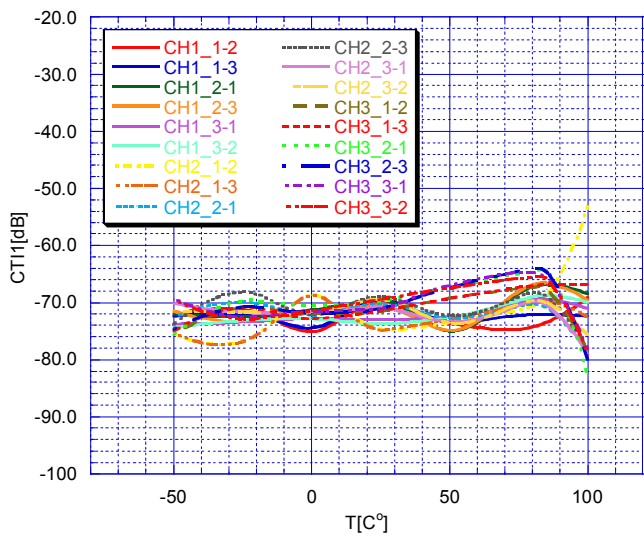

T vs CTI2

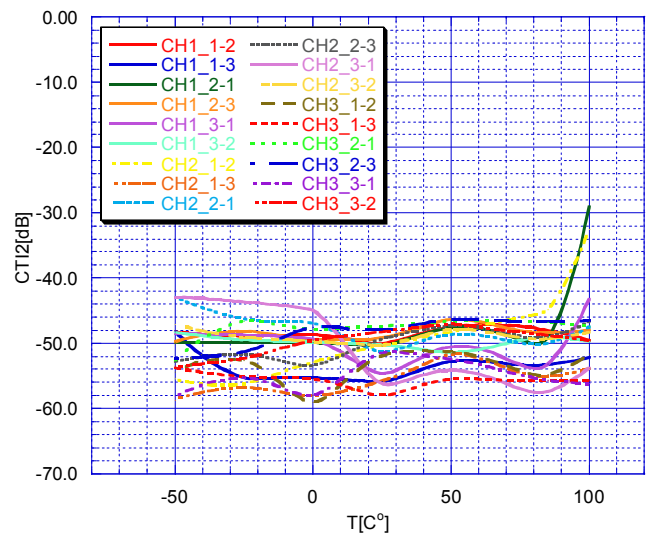

T vs CTB1

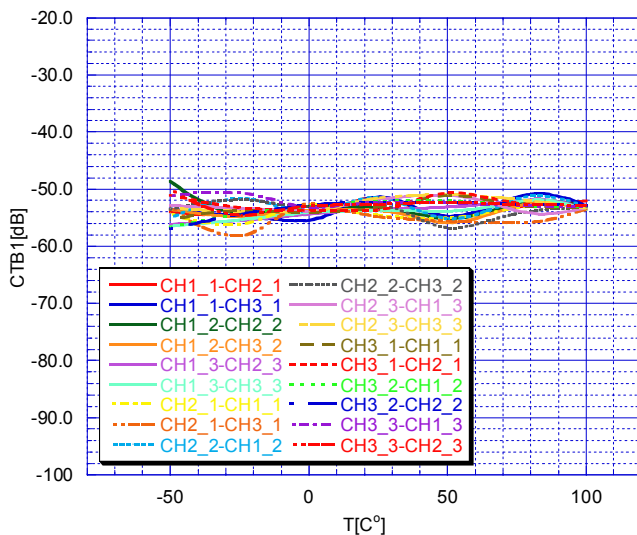

T vs CTB2

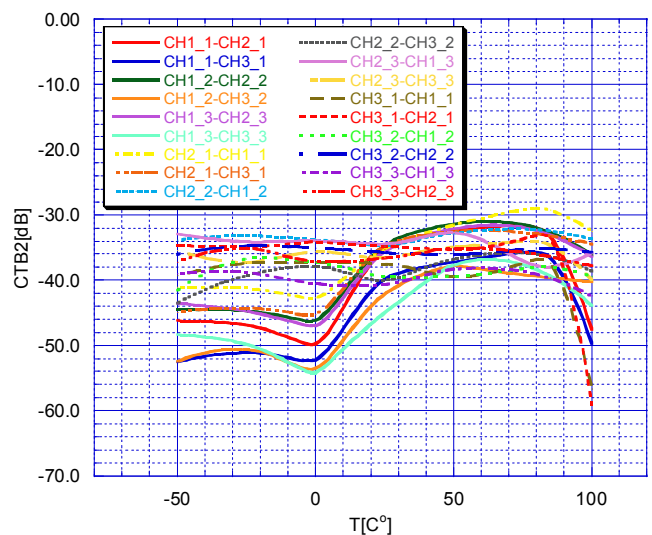

T vs SN

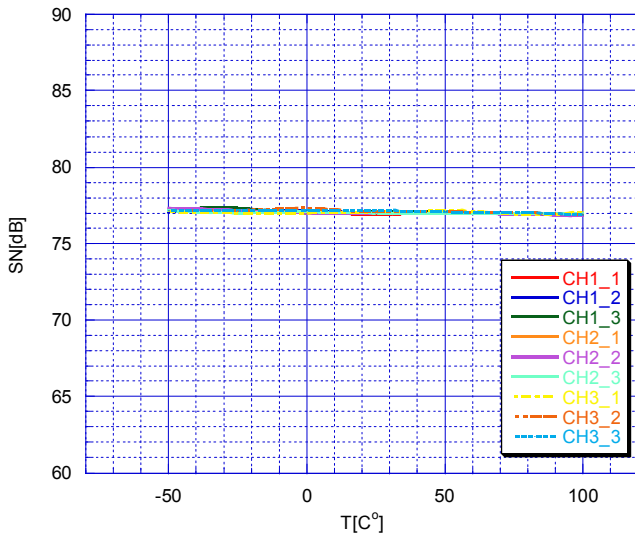

T vs DG

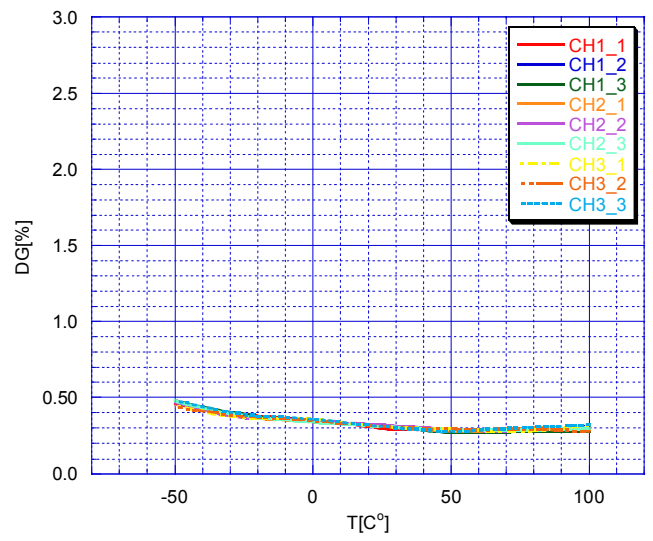

T vs DP

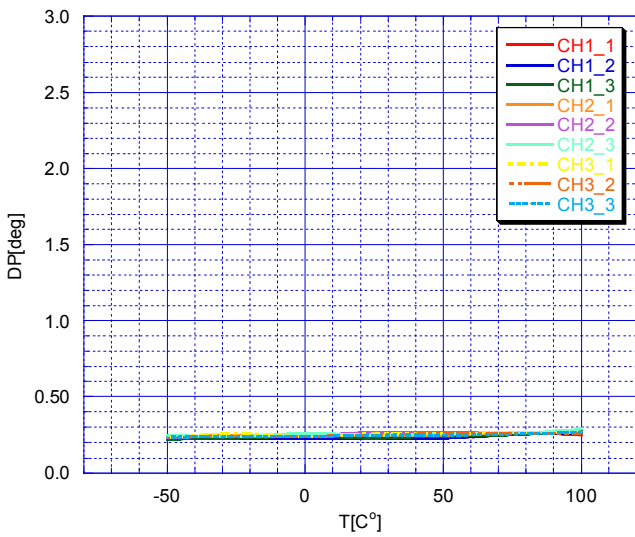

T vs SN

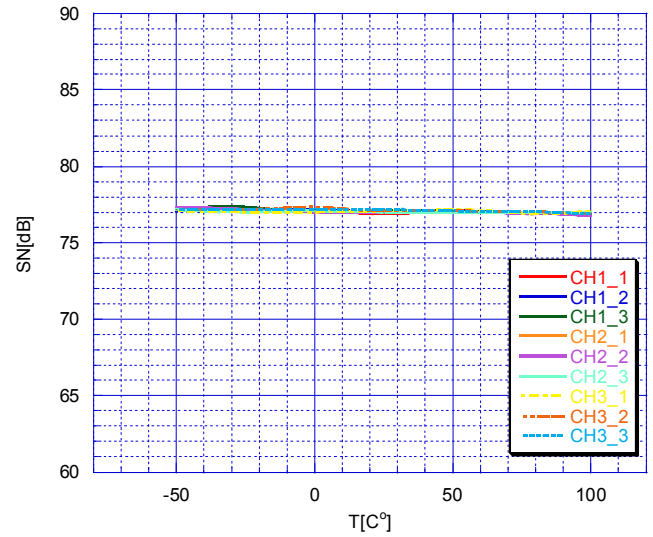

T vs VthS

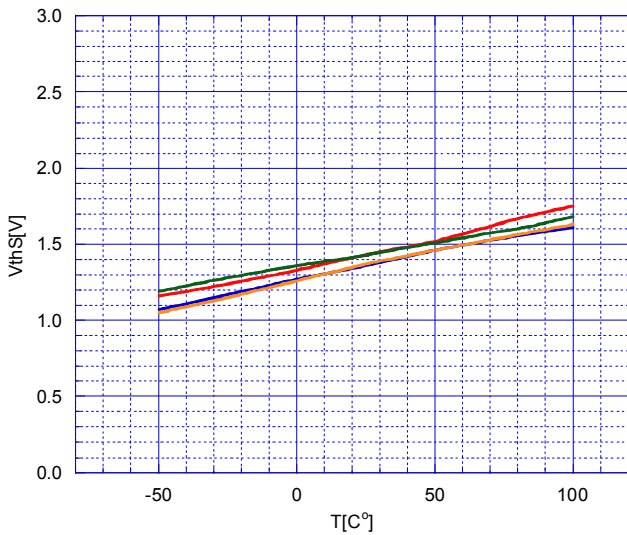

T vs VthP

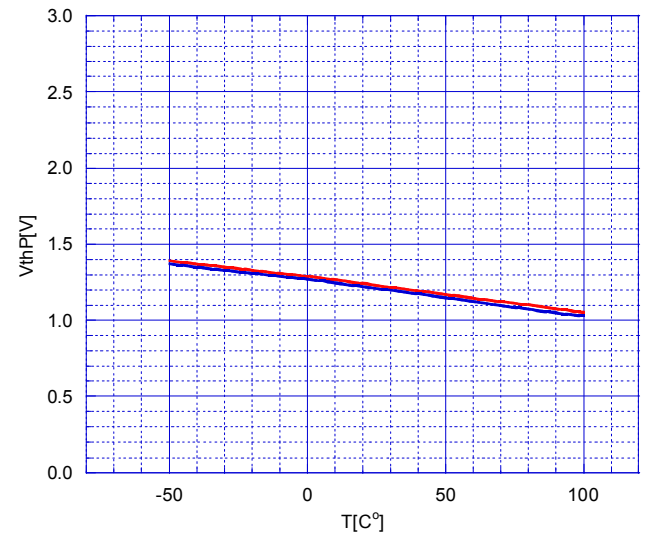



[CAUTION]
The specifications on this databook are only given for information, without any guarantee as regards either mistakes or omissions. The application circuits in this databook are described only to show representative usages of the product and not intended for the guarantee or permission of any right including the industrial rights.