



Website: [www.displaytech.com.hk](http://www.displaytech.com.hk)

# **LCD Module**

## **Product Specification**

**Product: DT043BTFT & DT043BTFT-TS**  
**4.3" TFT Display Module (480RGBx272DOTS)**

Contents in this document are subject to change without notice. No part of this document may be reproduced or transmitted in any form or by any means, electronic or mechanical, for any purpose, without the express written permission of Displaytech Ltd.

**3 November 2011.**

## 1. REVISION RECORD

| VERSION | CHANGES  | DATE            |
|---------|--|-----------------|
| 1.0     | Initial revision                                       | 25 July 2011    |
| 1.1     | Number of LEDs on page 5 was corrected.                | 27 July 2011    |
| 1.2     | Correct the resolution figure in Introduction section. | 3 August 2011   |
| 1.3     | Changed the temperature range of TS version            | 3 November 2011 |
|         |  |                 |
|         |  |                 |

**Table of Content**

**1. REVISION RECORD ..... 1**

**2. Introduction ..... 3**

**3. General Specifications ..... 3**

**4. Mechanical Drawing..... 4**

**5. Interface Description ..... 6**

**6. Absolute Maximum Ratings ..... 7**

**7. Electrical Characteristics..... 7**

**8. Display Controller /Power Supply Timing ..... 7**

**9. Backlight specification ..... 8**

**10. Optical Characteristics..... 8**

**11. Safety Precaution ..... 11**

## 2. Introduction

**DT043BTFT** and **DT043BTFT-TS** is a display module that contains a TFT display with a 272 \* 480 RGB resolution. The driver used for this project is the Himax **HX8257-A** or **compatible** and can display 16.7M colors. The driver is mounted on the glass and the interconnection via FPC including components to drive the display module.

## 3. General Specifications

| Item                        | Specification        | Unit |
|-----------------------------|----------------------|------|
| LCD mode                    | Transmissive         | ---  |
| Resolution                  | 480(RGB)             | Line |
|                             | 272                  | Line |
| Diagonal Size               | 4.3                  | Inch |
| Overall Size                | 105.50               | mm   |
|                             | 67.20                | mm   |
| Active area                 | 95.04                | mm   |
|                             | 53.86                | mm   |
| Optimum Viewing Direction   | 6 o'clock            | ---  |
| Driver IC                   | HX8257-A             | ---  |
| Interface type              | 24-bit digital (RGB) | ---  |
| Colours                     | 16.7M                | ---  |
| Operation temperature range | -20~70               | °C   |
| Storage temperature range   | -30~80               | °C   |

### Remarks:

- (1) Recommended mating connector: Hirose FH19SC-45S-0.5SH, FH12S-45S-0.5SH; or Molex 0512964593, 0512964594; or equivalent
- (2) Color tune may be changed slightly by temperature and driving voltage.
- (3) RoHS compliant.

### Component Life Cycle

- 1) Storage Life: min. 1 Year
- 2) Operation Life (\*1): min. 43 x 10<sup>3</sup> h (24hr/day x 7days/week x 52weeks/year x 5years)  
(Not include backlight)
- 3) Storage and Operation Life Times are defined for a temperature of +25°C

### Notes:

\*1. Operation life ends when one of the listed faults occurs:

- The on/off response-times reach 1.5 times of the max. value specified for a new display
- The contrast is reduced to 0.5 of the original contrast value
- Loss of function
- The number of cosmetic defects exceeds the maximum defined

### 4. Mechanical Drawing

- DT043BTFT

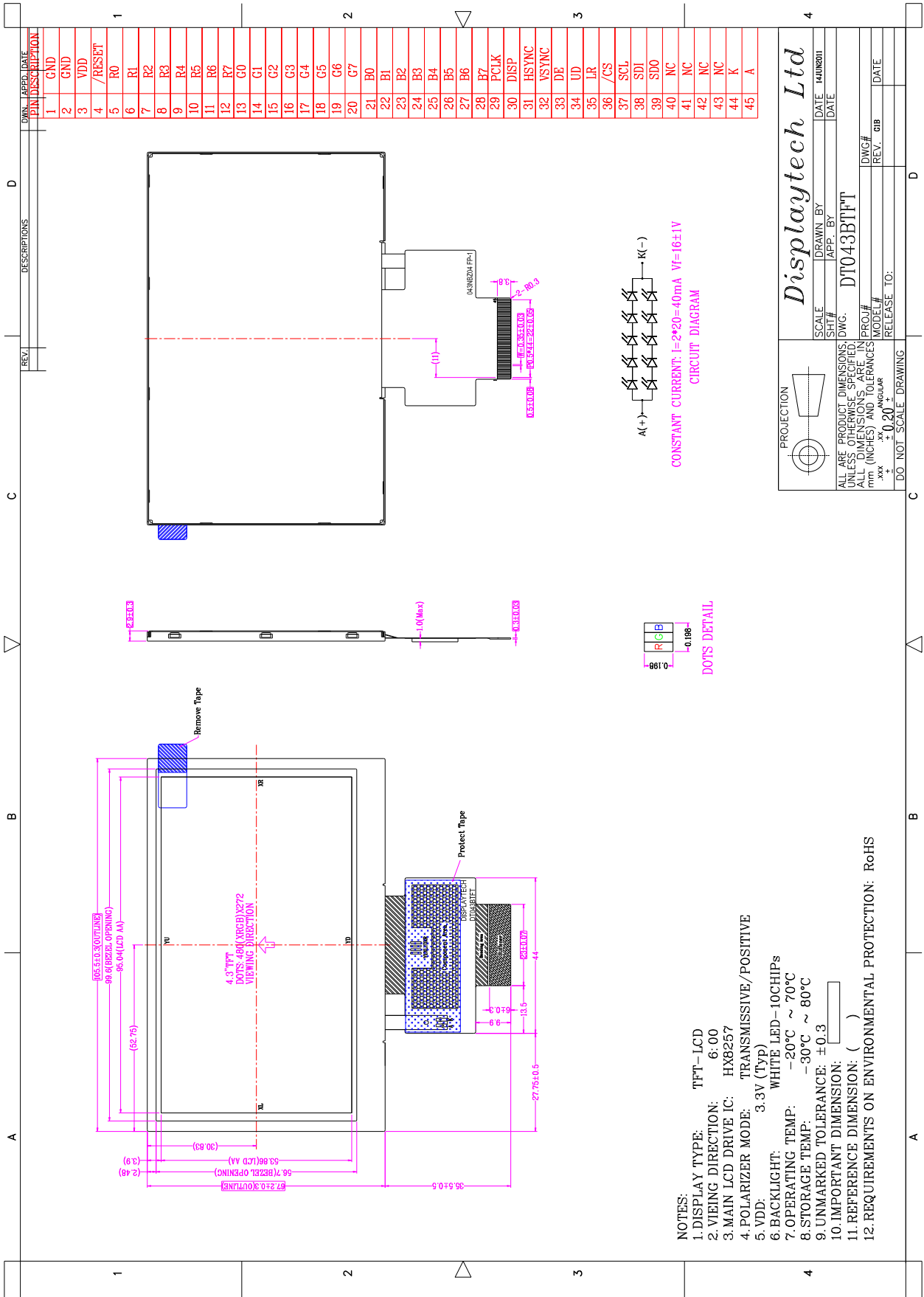

### • DT043BTFT-TS

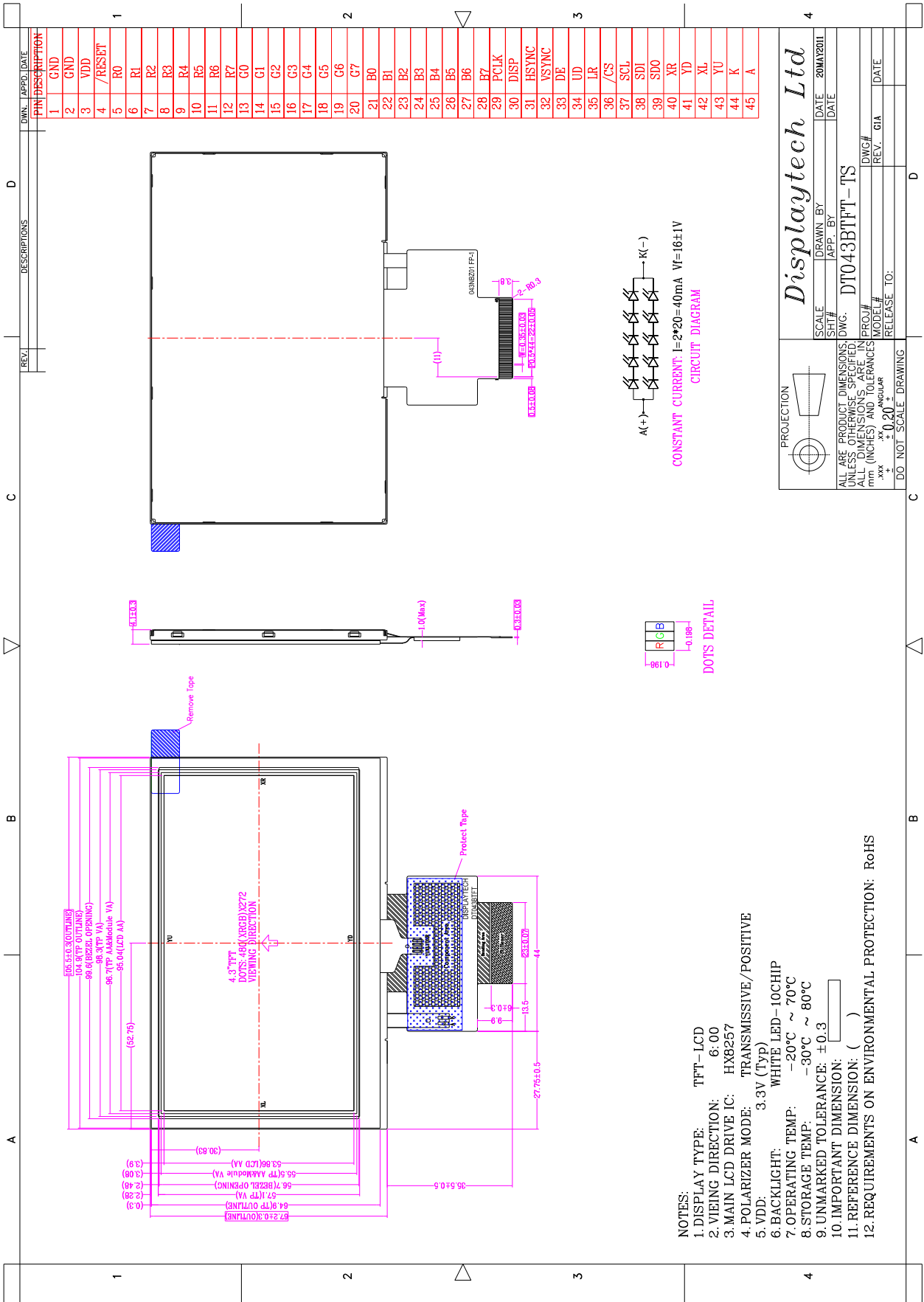

## 5. Interface Description

| Pin no | Symbol  | I/O | Description   |
|--------|---------|-----|---|
| 1~2    | GND     | --- | Power ground 0V   |
| 3      | VDD     | --- | Power supply 3.3V   |
| 4      | /RESET  | I   | Reset pin.  |
| 5~12   | R0 ~ R7 | I   | Red data  |
| 13~20  | G0 ~ G7 | I   | Green data  |
| 21~28  | B0 ~ B7 | I   | Blue data   |
| 29     | PCLK    | I   | Clock for Input Data.   |
| 30     | DISP    | I   | Display on/off mode control.<br>DISP=L: standby mode.<br>DISP=H: normal display mode. |
| 31     | HSYNC   | I   | Horizontal sync input with negative polarity.   |
| 32     | VSYNC   | I   | Vertical sync input with negative polarity.   |
| 33     | DE      | I   | Data Input Enable.  |
| 34     | UD      | I   | Shift direction selection signal<br>(UD=H: Up-->Down, UD=L: Down-->Up)                |
| 35     | LR      | I   | Scan direction selection signal<br>(LR=H: Left-->Right, LR=L: Right-->Left)           |
| 36     | /CS     | I   | Chip select pin of serial interface. Leave it OPEN when not used.                     |
| 37     | SCL     | I   | Serial clock input pin. Leave it OPEN when not used.                                  |
| 38     | SDI     | I   | Serial input signal. Leave it OPEN when not used.                                     |
| 39     | SDO     | O   | Serial output signal. Leave it OPEN when not used.                                    |
| 40     | NC / XR | --- | No connection (DT043BTFT) / XR of touch screen (DT043BTFT-TS)                         |
| 41     | NC / YD | --- | No connection (DT043BTFT) / YD of touch screen (DT043BTFT-TS)                         |
| 42     | NC / XL | --- | No connection (DT043BTFT) / XL of touch screen (DT043BTFT-TS)                         |
| 43     | NC / YU | --- | No connection (DT043BTFT) / YU of touch screen (DT043BTFT-TS)                         |
| 44     | K       | --- | Backlight cathode.  |
| 45     | A       | --- | Backlight anode.  |

## 6. Absolute Maximum Ratings

(Ta=25°C)

| Item                              | Symbol | Min. | Max.  | Unit |
|-----------------------------------|--------|------|-------|------|
| Power supply voltage              | VCC    | -0.3 | + 4.0 | V    |
| Logic signal input/output voltage | VDD    | -0.3 | + 4.0 | V    |
| Operating Temperature             | TOP    | -20  | +70   | °C   |
| Storage Temperature               | TST    | -30  | +80   | °C   |

Note:

- When temperature is below 0°C, the response time of liquid crystal (LC) will be slower and the color of panel will be darker.
- If module driving condition exceeds the absolute maximum ratings, permanent damaged may be resulted. If module is driven within the absolute maximum ratings but exceeded the DC characteristics, mal-function may be resulted.
- VDD/VCC > VSS

## 7. Electrical Characteristics

DC Characteristics

(Vss=0V, Ta=25°C)

| Item               | Symbol    | Condition  | Min.    | Typ. | Max.    | Unit |
|--------------------|-----------|------------|---------|------|---------|------|
| Power supply       | VCC / VDD |            | 3.135   | 3.3  | 3.465   | V    |
| Input voltage "H"  | VIH       | ---        | 0.7 VDD | ---  | VDD     | V    |
| Input voltage "L"  | VIL       | ---        | VSS     | ---  | 0.3 VDD | V    |
| Output voltage "H" | VOH       | IOH=-100uA | 0.9 VDD | ---  | VDD     | V    |
| Output voltage "L" | VOL       | IOH=100uA  | VSS     | ---  | 0.1 VDD | V    |

## 8. Display Controller /Power Supply Timing

See Display Controller Specification: Himax HX8257-A



### 9. Backlight specification

(Vcc=3.3V, Vss=0V, Ta=25°C)

| Item               | Symbol | Condition | Min   | Typ  | Max   | Unit | Note |
|--------------------|--------|-----------|-------|------|-------|------|------|
| Supply voltage     | Vf     | If=40mA   | 15.0  | 16.0 | 17.0  | V    | 2    |
| Forward current    | If     |           | ---   | ---  | 40    | mA   | 1, 2 |
| Uniformity         | ΔBp    | If=40mA   | 70    | ---  | ---   | %    |      |
| Color coordination | X      |           | 0.275 | ---  | 0.317 | ---  |      |
|                    | Y      |           | 0.275 | ---  | 0.317 | ---  |      |

LED circuit diagram:

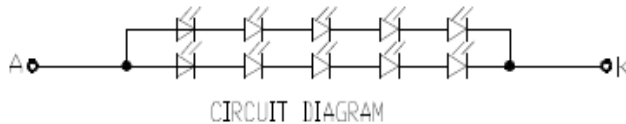

Constant current If=2x20mA=40mA; Vf=16.0V(typ)

Note:

- 1) The LED's driver mode needs to be constant current mode.
- 2) Permanent damage to the device may occur if maximum values are exceeded. Functional operation should be restricted to the conditions described under normal operating conditions.

### 10. Optical Characteristics

(Vcc=3.3V, Vss=0V, Ta=25°C)

| Item                      | Symbol                   | Condition    | Min      | Typ   | Max   | Unit              | Note |
|---------------------------|--------------------------|--------------|----------|-------|-------|-------------------|------|
| Brightness                | Bp                       | θ=0°         | 220      | ---   | ---   | cd/m <sup>2</sup> | 1    |
| Uniformity                | ΔBp                      | Φ=0°         | 70       | ---   | ---   | %                 | 1, 2 |
| Viewing Angle             | θ1<br>(Φ=90°<br>or 270°) | Cr≥10        | -70 ~ 50 |       |       | deg               | 3    |
|                           | θ2<br>(Φ=0°<br>or 180°)  |              | -70 ~ 70 |       |       |                   |      |
| Contrast ratio            | Cr                       | θ=0°         | 400      | 450   | ---   | ---               | 4    |
| Response Time             | Tr                       | Φ=0°         | ---      | 20    | 30    | ms                | 5    |
|                           | Tf                       |              |          |       |       |                   |      |
| CIE (x,y)<br>Chromaticity | White                    | x            | 0.273    | 0.323 | 0.373 | ---               | 1, 6 |
|                           |                          | y            | 0.298    | 0.348 | 0.398 |                   |      |
|                           | Red                      | x            | 0.536    | 0.586 | 0.636 |                   |      |
|                           |                          | y            | 0.307    | 0.357 | 0.407 |                   |      |
|                           | Green                    | x            | 0.294    | 0.344 | 0.394 |                   |      |
|                           |                          | y            | 0.427    | 0.577 | 0.527 |                   |      |
|                           | Blue                     | x            | 0.104    | 0.154 | 0.204 |                   |      |
|                           |                          | y            | 0.052    | 0.102 | 0.152 |                   |      |
| NTSC Ratio                | S                        | θ=0°<br>Φ=0° | ---      | 50    | ---   | %                 |      |

Note 1: The data are measured after LEDs are turned on for 5 minutes. LCM displays full white.  
The brightness is the average value of 9 measured spots. Measurement equipment PR-705 (Φ8mm)

Measuring condition:

- Measuring surroundings: Dark room.
- Measuring temperature: Ta=25°C.
- Adjust operating voltage to get optimum contrast at the center of the display.

Measured value at the center point of LCD panel after more than 5 minutes while backlight turning on.

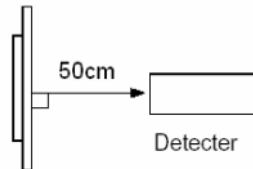

Note 2: The luminance uniformity is calculated by using following formula.

$$\Delta Bp = Bp (\text{Min.}) / Bp (\text{Max.}) \times 100 (\%)$$

Bp (Max.) = Maximum brightness in 9 measured spots

Bp (Min.) = Minimum brightness in 9 measured spots.

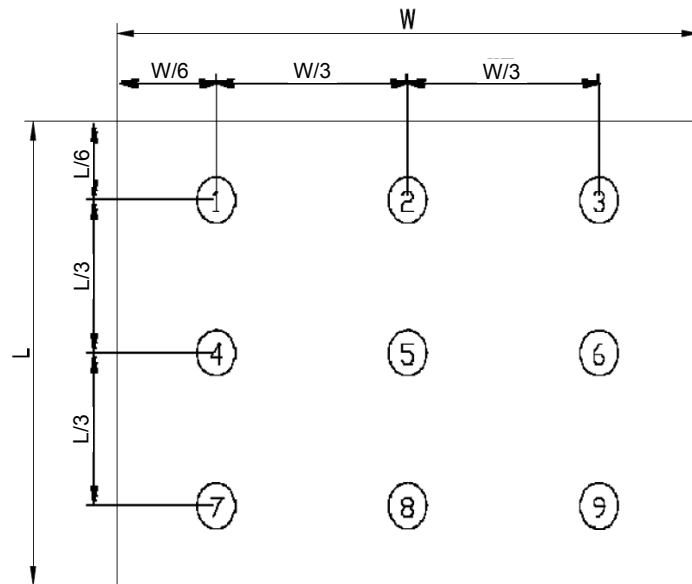

Measurement equipment PR-705 (Φ8mm)

Note 3: The definition of viewing angle:  
Refer to the graph below marked by  $\theta$  and  $\Phi$

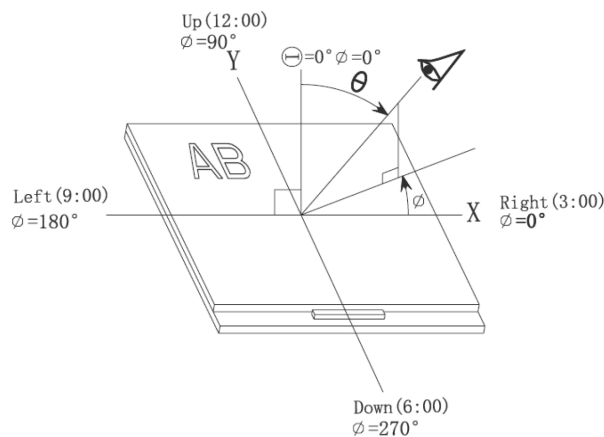

Note 4: The definition of contrast ratio (Test LCM using PR-705):

$$\text{Contrast Ratio (CR)} = \frac{\text{Luminance When LCD is at "White" state}}{\text{Luminance When LCD is at "Black" state}}$$

(Contrast Ratio is measured in optimum common electrode voltage)

Note 5: Definition of Response time. (Test LCD using DMS501):

The output signals of photo detector are measured when the input signals are changed from "black" to "white" (falling time) and from "white" to "black" (rising time), respectively.

The response time is defined as the time interval between the 10% and 90% of amplitudes. Refer to figure as below.

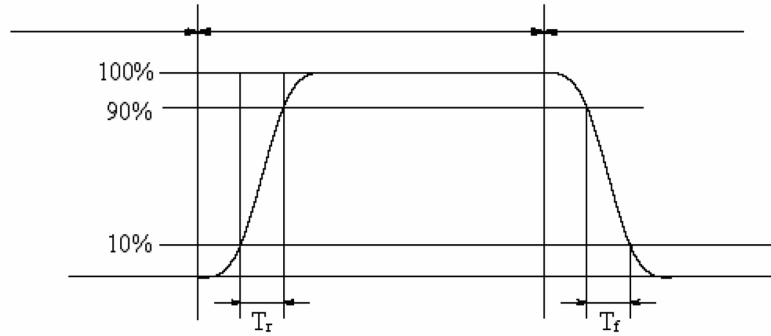

The definition of response time

Note 6: Definition of Color of CIE Coordinate and NTSC Ratio.

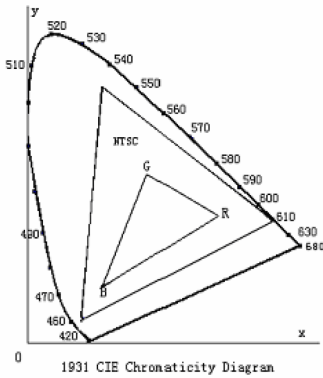

**Color gamut:**

$$S = \frac{\text{area of RGB triangle}}{\text{area of NTSC triangle}} \times 100\%$$

## 11. Safety Precaution

### Handling precautions:

- This device is susceptible to Electro-Static Discharge (ESD) damage. Observe Anti-Static precautions.

### Power supply precautions:

- Identify and, at all times, observe absolute maximum ratings for both logic and LC drivers. Note that there is some variance between models.
- Prevent the application of reverse polarity to VCC and GND, however briefly.
- Use a clean power source free from transients. Power up conditions are occasionally “jolting” and may exceed the maximum ratings of the modules.
- The VCC power of the module should also supply the power to all devices that may access the display. Don’t allow the data bus to be driven when the logic supply to the module is turned off.

### Operating precautions:

- DO NOT plug or unplug the module when the system is powered up.
- Minimize the cable length between the module and host MPU.
- Operate the module within the limits of the modules temperature specifications.

### Mechanical/Environmental precautions:

- Improper soldering is the major cause of module difficulty. Use of flux cleaner is not recommended as they may seep under the elastomeric connection and cause display failure.
- Mount the module so that it is free from torque and mechanical stress.
- Surface of the LCD panel should not be touched or scratched. The display front surface is an easily scratched, plastic polarizer. Avoid contact and clean only when necessary with soft, absorbent cotton dampened with petroleum benzene.
- Always employ anti-static procedure while handling the module.
- Prevent moisture build-up upon the module and observe the environmental constraints for storage temperature and humidity.
- Do not store in direct sunlight
- If leakage of the liquid crystal material should occur, avoid contact with this material, particularly ingestion. If the body or clothing becomes contaminated by the liquid crystal material, wash thoroughly with water and soap