

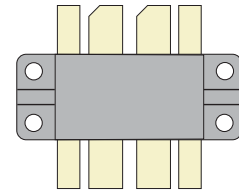

Common Source
Push-Pull Pair

ARF475FL

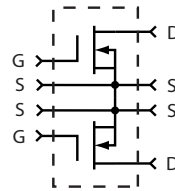

RF POWER MOSFET N-CHANNEL PUSH - PULL PAIR

165V 450W 150MHz

The ARF475FL is a matched pair of RF power transistors in a common source configuration. It is designed for high voltage push-pull or parallel operation in narrow band ISM and MRI power amplifiers up to 150 MHz.

- **Specified 150 Volt, 128 MHz Characteristics:**
 - Output Power = 900 Watts Peak
 - Gain = 15dB (Class AB)
 - Efficiency = 50% min
- **High Performance Push-Pull RF Package.**
- **High Voltage Breakdown and Large SOA for Superior Ruggedness.**
- **Low Thermal Resistance.**
- **RoHS Compliant *** 
*Pb Free Terminal Finish.

MAXIMUM RATINGS

All Ratings: $T_C = 25^\circ\text{C}$ unless otherwise specified.

Symbol	Parameter	ARF475FL	UNIT
V_{DSS}	Drain-Source Voltage	500	Volts
V_{DGO}	Drain-Gate Voltage	500	
I_D	Continuous Drain Current @ $T_C = 25^\circ\text{C}$ (each device)	10	Amps
V_{GS}	Gate-Source Voltage	± 30	Volts
P_D	Total Device Dissipation @ $T_C = 25^\circ\text{C}$	910	Watts
T_J, T_{STG}	Operating and Storage Junction Temperature Range	-55 to 175	$^\circ\text{C}$
T_L	Lead Temperature: 0.063" from Case for 10 Sec.	300	

STATIC ELECTRICAL CHARACTERISTICS (each device)

Symbol	Characteristic / Test Conditions	MIN	TYP	MAX	UNIT
BV_{DSS}	Drain-Source Breakdown Voltage ($V_{GS} = 0\text{V}, I_D = 250 \mu\text{A}$)	500			Volts
$V_{DS(ON)}$	On State Drain Voltage ^① ($I_{D(ON)} = 5\text{A}, V_{GS} = 10\text{V}$)		2.9	4	
I_{DSS}	Zero Gate Voltage Drain Current ($V_{DS} = V_{DSS}, V_{GS} = 0\text{V}$)			100	μA
	Zero Gate Voltage Drain Current ($V_{DS} = 50\text{V}, V_{GS} = 0, T_C = 125^\circ\text{C}$)			500	
I_{GSS}	Gate-Source Leakage Current ($V_{GS} = \pm 30\text{V}, V_{DS} = 0\text{V}$)			± 100	nA
g_{fs}	Forward Transconductance ($V_{DS} = 15\text{V}, I_D = 5\text{A}$)	3	3.6		mhos
g_{fs1}/g_{fs2}	Forward Transconductance Match Ratio ($V_{DS} = 15\text{V}, I_D = 5\text{A}$)	0.9		1.1	Volts
$V_{GS(TH)}$	Gate Threshold Voltage ($V_{DS} = V_{GS}, I_D = 200\text{mA}$)	2	3.3	4	
$DV_{GS(TH)}$	Gate Threshold Voltage Match ($V_{DS} = V_{GS}, I_D = 200\text{mA}$)			0.2	

THERMAL CHARACTERISTICS

Symbol	Characteristic	MIN	TYP	MAX	UNIT
$R_{\theta JC}$	Junction to Case		0.15	0.165	$^\circ\text{C/W}$
$R_{\theta JHS}$	Junction to Sink (Use High Efficiency Thermal Grease and Planar Heat Sink Surface.)		0.30	0.33	

 **CAUTION:** These Devices are Sensitive to Electrostatic Discharge. Proper Handling Procedures Should Be Followed.

Symbol	Characteristic	Test Conditions	MIN	TYP	MAX	UNIT
C_{iss}	Input Capacitance	$V_{GS} = 0V$ $V_{DS} = 50V$ $f = 1MHz$		780	830	pF
C_{oss}	Output Capacitance			125	130	
C_{rss}	Reverse Transfer Capacitance			7	9	
$t_{d(on)}$	Turn-on Delay Time	$V_{GS} = 15V$ $V_{DD} = 250V$ $I_D = I_{D[Cont.]} @ 25^\circ C$ $R_G = 1.6 W$		5.1	10	ns
t_r	Rise Time			4.1	8	
$t_{d(off)}$	Turn-off Delay Time			12	18	
t_f	Fall Time			4.0	7	

FUNCTIONAL CHARACTERISTICS (Push-Pull Configuration)

Symbol	Characteristic	Test Conditions	MIN	TYP	MAX	UNIT
G_{PS}	Common Source Amplifier Power Gain	$f = 128 MHz$ $I_{dq} = 15mA$ $V_{DD} = 150V$ $P_{out} = 900W$ $PW = 3ms$ 10% duty cycle	14	16		dB
η	Drain Efficiency		50	55		%
ψ	Electrical Ruggedness VSWR 5:1		No Degradation in Output Power			

① Pulse Test: Pulse width < 380 μs , Duty Cycle < 2%.

Microsemi Reserves the right to change, without notice, the specifications and information contained herein.

Per transistor section unless otherwise specified.

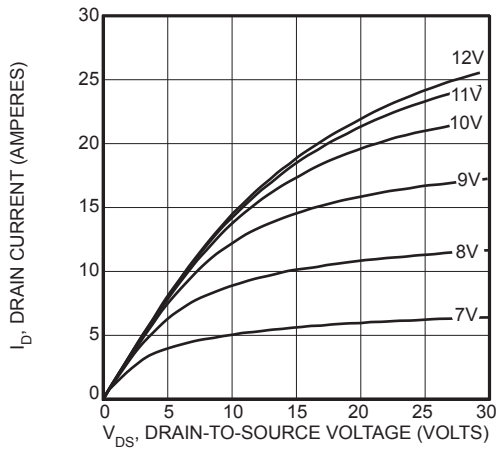

Figure 1, Typical Output Characteristics

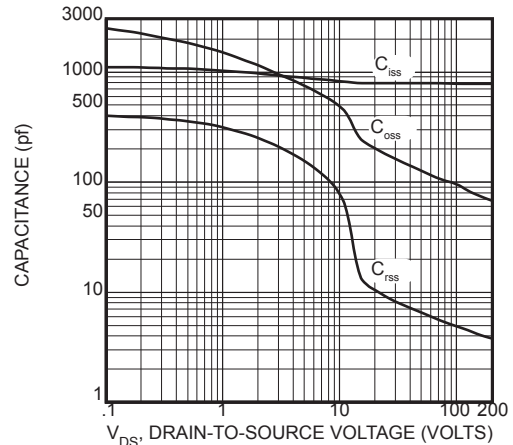

Figure 2, Typical Capacitance vs. Drain-to-Source Voltage

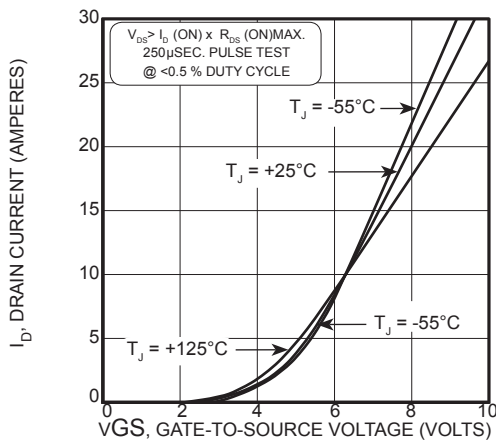

Figure 3, Typical Transfer Characteristics

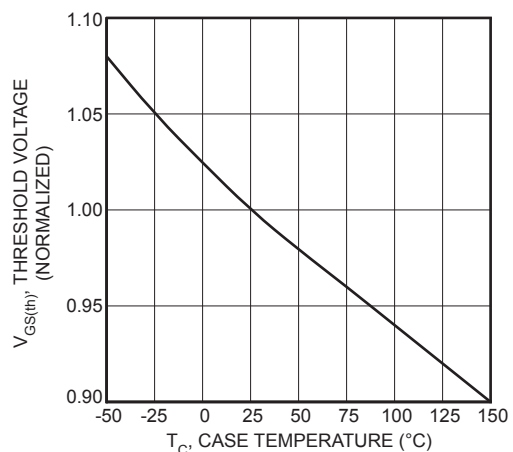

Figure 4, Typical Threshold Voltage vs Temperature

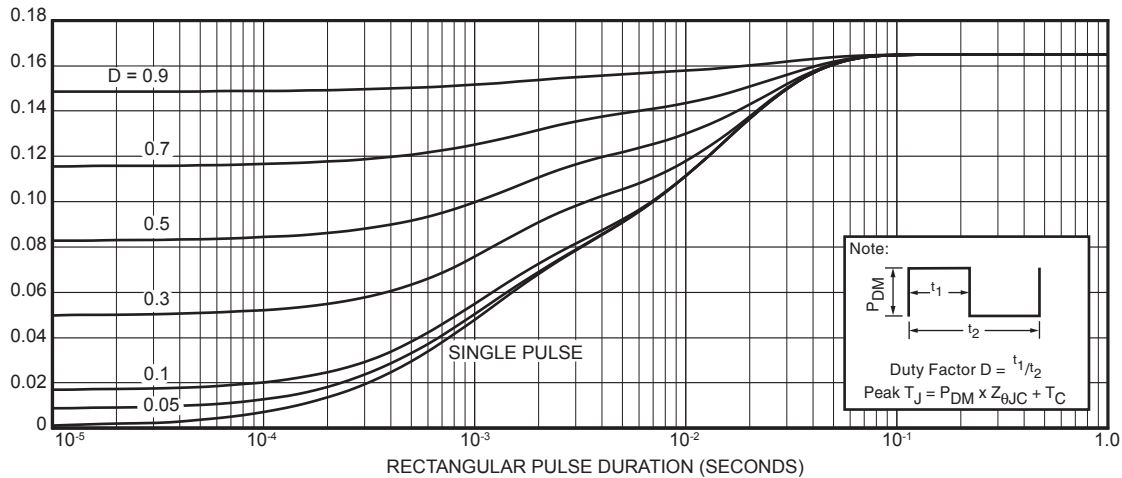

FIGURE 5a, MAXIMUM EFFECTIVE TRANSIENT THERMAL IMPEDANCE, JUNCTION-TO-CASE vs PULSE DURATION

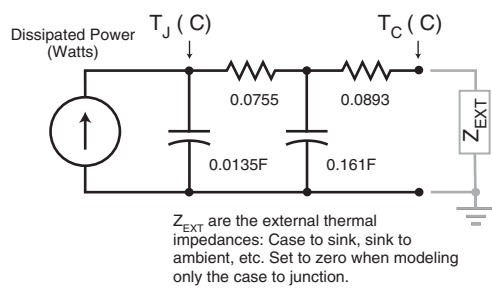

Figure 5b, TRANSIENT THERMAL IMPEDANCE MODEL

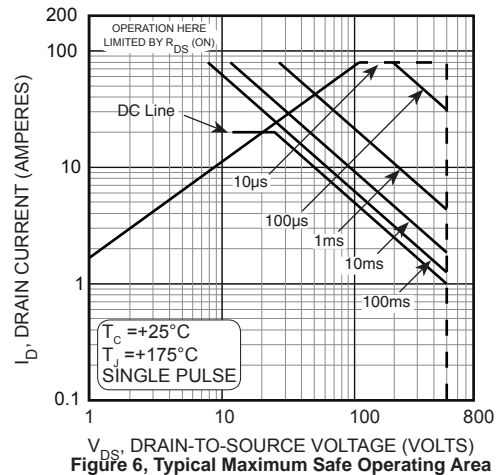

Figure 6, Typical Maximum Safe Operating Area

Table 1 - Typical Series Equivalent Large Signal Input - Output Impedance

Freq. (MHz)	Z _{in} (Ω) gate to gate	Z _{OL} (Ω) drain - drain
30	5.2 -j10	41 -j20
60	1.37 -j5.2	26 -j25
90	.53 -j2.6	16 -j23
120	.25 -j1.0	10 -j20
150	.25 +j0.2	6.7 -j17

Z_{in} - Gate -gate shunted with 25Ω I_{DQ} = 15mA each side

Z_{OL} - Conjugate of optimum load for 600 Watts peak output at V_{dd} = 150V
25% duty cycle and PW = 5ms

128MHz Test amplifier
 Po = 900W @150V
 3ms pulse 10% Duty Cycle

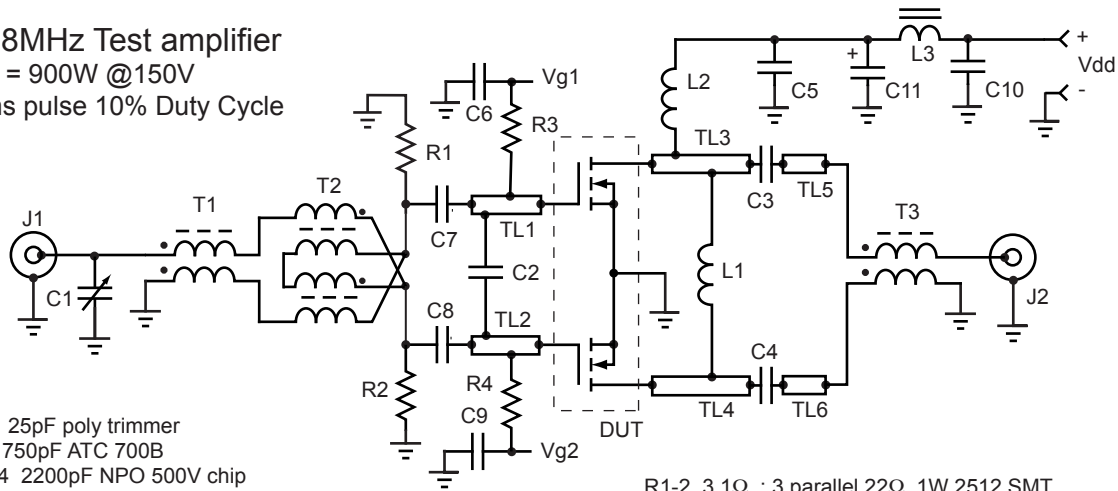

- C1 25pF poly trimmer
- C2 750pF ATC 700B
- C3-4 2200pF NPO 500V chip
- C5-10 10nF 500V chip
- C11 1000uF 250V electrolytic
- L1 30nH 1.5t #18 enam .375" dia
- L2 680nH 12t #24 enam .312" dia
- L3 2t #20 on Fair-Rite 2643006302 bead, ~ 2uH

- R1-2 3.1Ω : 3 parallel 22Ω 1W 2512 SMT
- R3-4 2.2kΩ 1/4W axial
- T1 1:1 balun 50Ω coax on Fair-Rite 2843000102 core
- T2 4:1 25Ω coax on 2843000102 Fair-Rite balun core
- T3 1:1 coax balun RG-303 on 2861006802 Fair-Rite core
- TL1-2 Printed line L= 0.75" w=.23"
- TL3-6 Printed line L= 0.65" w=.23"
 0.23" wide stripline on FR-4 board is ~ 30Ω Zo

Peak Output Power vs. Vdd and Duty Cycle

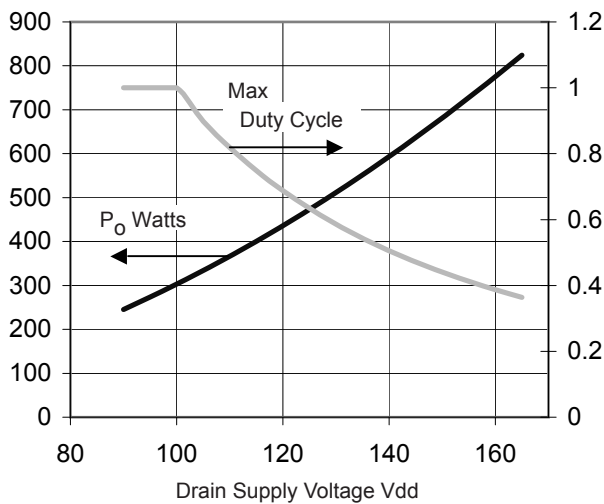

Notes:

The value of L1 must be adjusted as the supply voltage is changed to maintain resonance in the output circuit. At 128MHz its value changes from approximately 40nH at 100V to 30nH at 150V.

With the 50Ω drain-to-drain load, the duty cycle above 100V must be reduced to insure power dissipation is within the limits of the device. Maximum pulse length should be 100mS or less. See transient thermal impedance, figure 5.

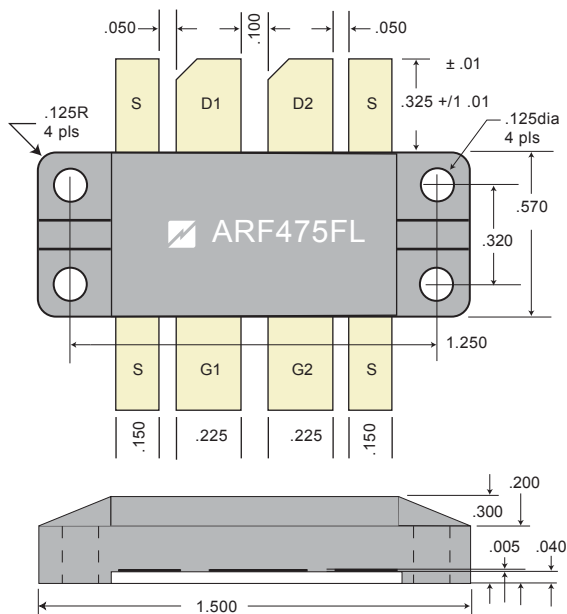

Thermal Considerations and Package Mounting:

The rated power dissipation is only available when the package mounting surface is at 25°C and the junction temperature is 175°C. The thermal resistance between junctions and case mounting surface is 0.16°C/W. When installed, an additional thermal impedance of 0.15°C/W between the package base and the mounting surface is typical. Insure that the mounting surface is smooth and flat. Thermal joint compound must be used to reduce the effects of small surface irregularities. Use the minimum amount necessary to coat the surface. The heatsink should incorporate a copper heat spreader to obtain best results.

The package design clamps the ceramic base to the heatsink. A clamped joint maintains the required mounting pressure while allowing for thermal expansion of both the base and the heat sink. Four 4-40 (M3) screws provide the required mounting force. T = 6 in-lb (0.68 N-m).

HAZARDOUS MATERIAL WARNING

The white ceramic portion of the device between leads and mounting surface is beryllium oxide, BeO. Beryllium oxide dust is toxic when inhaled. Care must be taken during handling and mounting to avoid damage to this area. These devices must never be thrown away with general industrial or domestic waste.