

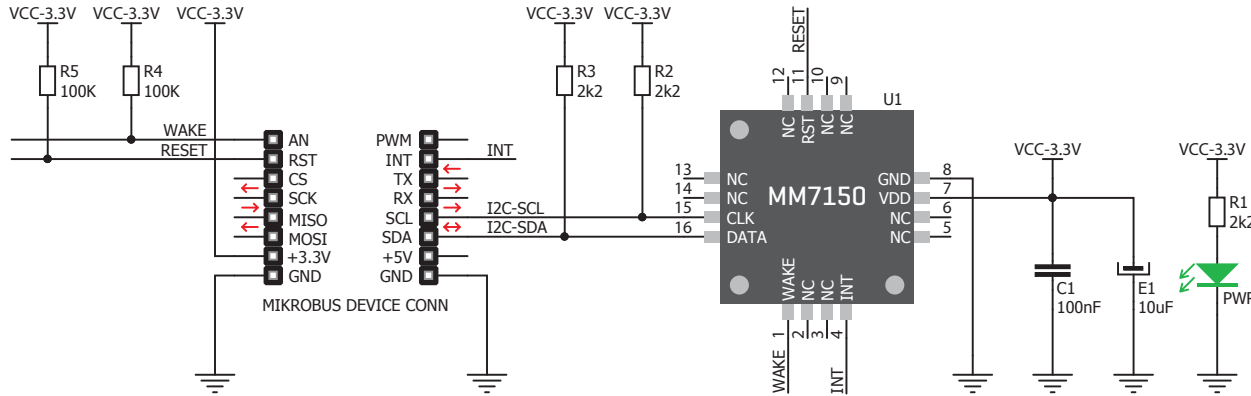

## 5. Schematic

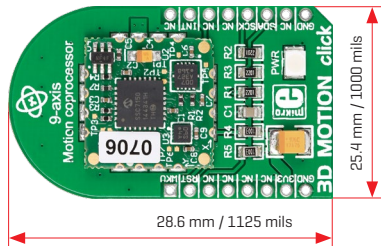

## 6. Dimensions



	mm	mils
LENGTH	42.9	1690
WIDTH	25.4	1000
HEIGHT*	4.65	183

\* without headers

## 7. Sensors onboard



The MM7150 motion module consists of three chips: Bosch BMC150 accelerometer,

Bosch BMG160 Gyroscope, and Microchip's SSC7150 motion coprocessor.

## 8. Code examples

Once you have done all the necessary preparations, it's time to get your click board™ up and running. We have provided examples for mikroC™, mikroBasic™ and mikroPascal™ compilers on our **Libstock** website. Just download them and you are ready to start.



## 9. Support

MikroElektronika offers **free tech support** [[www.mikroe.com/support](http://www.mikroe.com/support)] until the end of the product's lifetime, so if something goes wrong, we're ready and willing to help!



## 10. Disclaimer

MikroElektronika assumes no responsibility or liability for any errors or inaccuracies that may appear in the present document. Specification and information contained in the present schematic are subject to change at any time without notice.

Copyright © 2015 MikroElektronika.  
All rights reserved.