

### Main

Range of product	Zelio Relay
Product or component type	Solid state relay
Device short name	SSL
Phase	1 phase

### Complementary

Mounting support	Socket
Line Rated Current	0.1 A
Output voltage	1...48 V DC
[Uc] control circuit voltage	3...12 V DC
Contacts type and composition	1 NO
Capacitance unbalance	1.5 pF input/output
Minimum switching voltage	3 V DC turn-on
Maximum switching voltage	1 V DC turn-off
Input current limits	4 mA
Input impedance	1250 Ohm
Solid state output type	Transistor output DC switching
Load current	0.001...0.1 A
Absolute maximum voltage	60 V DC
Maximum operating frequency	500 Hz
Surge current	0.3 A 10 ms
Voltage drop	<= 1 V on-state
Leakage current	<= 0.001 mA off-state
Response time	0.02 ms turn-on 0.13 ms turn-off
Overvoltage category	III
Width	0.2 in (5 mm)
Height	1.1 in (28 mm)
Depth	0.59 in (15 mm)
Product weight	0.01 lb(US) (0.0041 kg)

### Environment

flame retardance	V0 conforming to UL 94
dielectric strength	3750 V input/output
pollution degree	2
product certifications	CSA RoHS UL REACH
marking	CE
ambient air temperature for operation	-4...176 °F (-20...80 °C)
ambient air temperature for storage	-4...185 °F (-20...85 °C)

The information provided in this documentation contains general descriptions and/or technical characteristics of the performance of the products contained herein. This documentation is not intended as a substitute for and is not to be used for determining suitability or reliability of these products for specific user applications. It is the duty of any such user or integrator to perform the appropriate and complete risk analysis, evaluation and testing of the products with respect to the relevant specific application or use thereof. Neither Schneider Electric Industries SAS nor any of its affiliates or subsidiaries shall be responsible or liable for misuse of the information contained herein.

## Offer Sustainability

Green Premium product	Green Premium product
Compliant - since 1417 - Schneider Electric declaration of conformity	Compliant - since 1417 - Schneider Electric declaration of conformity
Reference not containing SVHC above the threshold	Reference not containing SVHC above the threshold
Available	Available
Need no specific recycling operations	Need no specific recycling operations
WARNING: This product can expose you to chemicals including:	WARNING: This product can expose you to chemicals including:
Lead and lead compounds, which is known to the State of California to cause cancer and birth defects or other reproductive harm.	Lead and lead compounds, which is known to the State of California to cause cancer and birth defects or other reproductive harm.
For more information go to <a href="http://www.p65warnings.ca.gov">www.p65warnings.ca.gov</a>	For more information go to <a href="http://www.p65warnings.ca.gov">www.p65warnings.ca.gov</a>

## Dimensions

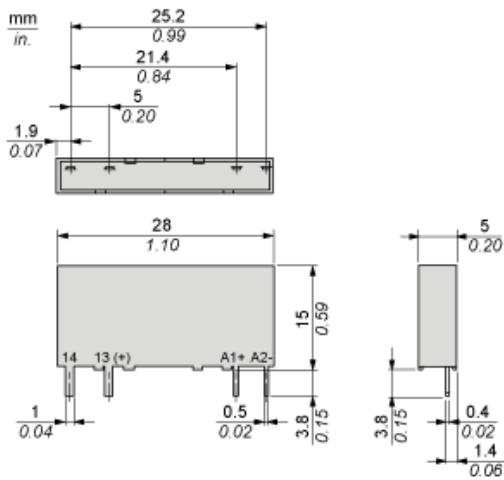

## Derating Curves

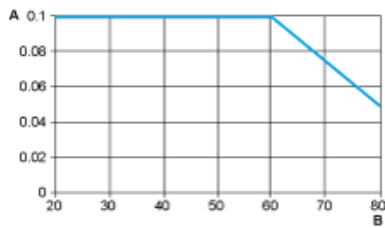

A : Load Current (Amperes)

B : Ambient Temperature (°C)