

Type 4295 Series

Type 4295 Series



These long established 10mm square, single turn potentiometers will meet a wide range of industrial and professional applications. Cermet element technology ensures stability and reliability. This P.C.B. mounted package has easy top or side adjustment, or finger adjust styles. All components are sealed to withstand printed circuit board washing solvents.

Key Features

- High Resolution Cermet Element For Stability
- Enclosure Sealed
- 0.5 Watt Rating at 85°C
- Flame Retardant
- P.C.B. Standoffs
- Robust Construction
- Vertical or Horizontal Adjustments Available
- Finger Adjustment Available

Characteristics - Electrical

Resistance Range:	100R to 2M
STD Resistance Values:	1, 2 and 5 in each decade
STD Resistance Tolerance:	± 10%
End Resistance:	20hms or 1% whichever is greater
Slider Current:	100 mA or within power rating, Max.
Power Rating, Watts:	0.5 at 85°C derating to zero at 125°C
Isolation Voltage:	300 V dc or ac peak
Limiting Element Voltage:	220 V dc or ac RMS, Max.
Breakdown Voltage. (Sea Level):	900 V ac for one minute
Insulation Resistance:	1000 M Ohms at 500 V dc, Min.
Resolution:	Essentially Infinite
Rotational Noise (CRV):	3 Ohms or 2 % min.
Temperature Coefficient:	± 250 ppm/°C, Max.
Electrical Adjustment:	280° Nominal

Characteristics - Mechanical

End Stop:	40 mNm Min.
Starting Torque:	35 mNm Max.
Mechanical Adjustment:	300° Nominal
Weight:	0.85 gm Nominal
Solderability:	MIL Std 202 Method 208A

Characteristics - Environmental

Temperature Range:	-55°C to +125°C
Temperature Storage:	250 Hrs at 125°C
Thermal Shock:	5 Cycles -55°C to +125°C
Bump Severity:	4000 Bumps; 40G
Vibration Severity:	10 - 500Hz; 30 G
Rotational Life:	200 Cycles, Min.
Load Life at 70°C:	ΔR < 3% after 1000 Hrs. at 0.5 watts
Sealing:	Sealed for board washing (85°C Florinert)
Climatic Category:	55/125/56
Humidity:	MIL - Std - 202G Method 103 (96hrs)

Dimensions 4295P



Type 4295 Series

**Dimensions
4295M**



4295X

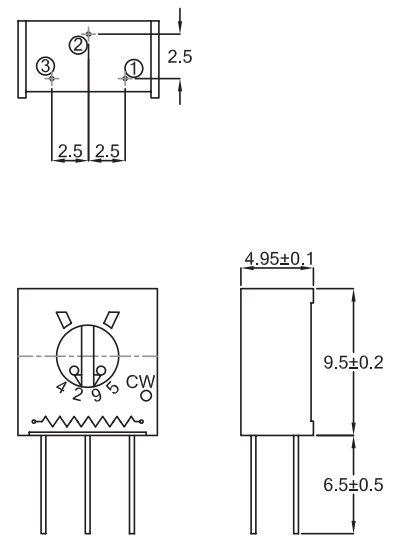

4295MF/PF



4295PF



4295MF

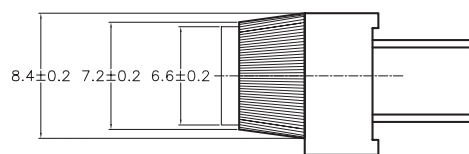

How to Order

4295	P	104	K
Common Part	Pin Configuration	Resistance Value	Tolerance
4295	M – Top Adjust 5mm x 5mm MF – Finger Top Adjust 5mm x 5mm P – Top Adjust 5mm x 2.5mm PF – Finger Top Adjust 5mm x 2.5mm X – Side Adjust 5mm x 2.5mm	The first two digits are significant figures of resistance value and the third denotes the number of zeros following. e.g. 100R: 101 1K: 102 10K: 103 100K: 104	K - 10 %

Mouser Electronics

Authorized Distributor

Click to View Pricing, Inventory, Delivery & Lifecycle Information:

[TE Connectivity:](#)

[404806392010](#)